

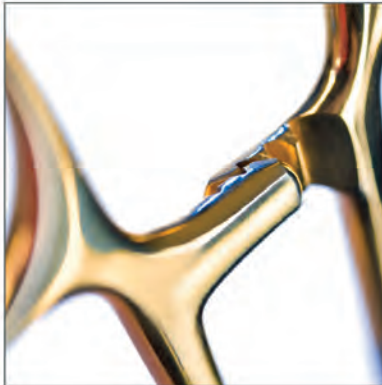

Chirurgische Instrumente  
 Surgical Instruments  
 Instrumentos quirúrgicos  
 Strumenti chirurgici

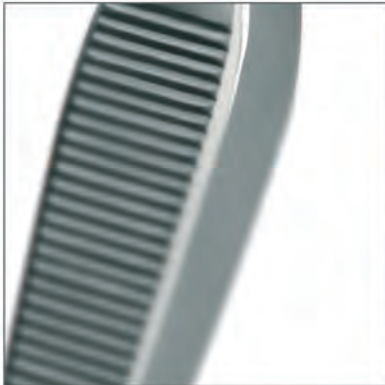
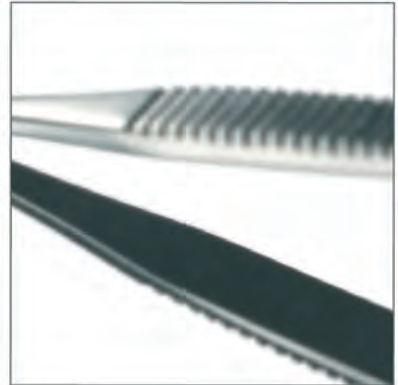

Charrière (Ch) French (F)	Durchmesser in mm	Inches
1	0,33	0,013
2	0,67	0,025
3	1,00	0,039
4	1,33	0,051
5	1,67	0,065
6	2,00	0,0787
7	2,33	0,092
8	2,67	0,105
9	3,00	0,1181
10	3,33	0,131
11	3,67	0,144
12	4,00	0,1575
13	4,33	0,170
14	4,67	0,184
15	5,00	0,1968
16	5,33	0,210
17	5,67	0,223
18	6,00	0,2362
19	6,33	0,249
20	6,67	0,263
21	7,00	0,2756
22	7,33	0,288
23	7,67	0,302
24	8,00	0,3150
25	8,33	0,328
26	8,67	0,341
27	9,00	0,3543
28	9,33	0,367
29	9,67	0,380
30	10,00	0,3973
31	10,33	0,407
32	10,67	0,420
34	11,33	0,446
36	12,00	0,4724
38	12,67	0,494
40	13,33	0,5199
45	15,00	0,5905

Gauge (G)	Durchmesser in mm	Inches
35	0,13	0,005
34	0,18	0,007
33	0,20	0,008
32	0,23	0,009
31	0,25	0,010
30	0,30	0,012
29	0,33	0,013
28	0,36	0,014
27	0,41	0,016
26	0,46	0,018
25	0,51	0,020
	0,53	0,021
24	0,56	0,022
23	0,64	0,025
22	0,71	0,028
21	0,81	0,032
20	0,89	0,035
	0,97	0,038
19	1,07	0,042
18	1,27	0,050
17	1,50	0,059
16	1,65	0,065
15	1,83	0,072
14	2,11	0,083
13	2,41	0,095
12	2,77	0,109
11	3,05	0,120
10	3,40	0,134
9	3,76	0,148
8	4,19	0,165
7	4,57	0,180
6	5,16	0,203

1 OZ	0,028 ml
5 OZ	0,140 ml
16 OZ	0,450 ml

35 OZ	1,0 l
128 OZ	3,7 l

## Index

03: Diagnostik  
05: Narkose  
07: Skalpelle, Messer  
09: Scheren  
10: Mikroscheren  
11: Pinzetten  
12: Mikrochirurgie-Pinzetten  
  
13: Klemmen  
15: Tuchklemmen  
17: Tupferzangen  
19: Wundhaken  
21: Sonden, Watteträger  
23: Trokare, Biopsiekanülen,  
Führungsnadeln  
25: Nadelhalter  
27: Naht  
29: Sterilisations-Instrumente  
  
31: Verband, Gips  
33, 34: Knochenchirurgie  
41: Neurochirurgie  
43, 44: Ophthalmologie  
45: Otologie  
47: Rhinologie  
49: Mund und Zunge  
51: Tonsillektomie  
53: Laryngo-, Bronchoskopie  
55: Tracheotomie  
57: Thorax  
61: Herz- und Gefäßchirurgie  
63: Galle  
65: Magen, Darm  
67: Urologie  
69: Rektum  
71: Gynäkologie  
73: Geburtshilfe  
75: Dermatologie  
89: Sterilisation, Behälter  
91: Hochfrequenz-Chirurgie

## Index

Diagnostic  
Anesthesia  
Scalpels  
Scissors  
Micro Scissors  
Thumb and Tissue Forceps  
Microsurgery Forceps  
Atrauma Bulldog Clamps  
Hemostatic Forceps  
Towel Forceps  
Dressing Forceps  
Retractors  
Probes, Cotton Applicators  
Trocars  
  
Needle Holders  
Suturing Instruments  
Sterilization Instruments  
  
Plaster of Paris  
Bone Surgery  
Neurosurgery  
Ophthalmology  
Otology  
Rhinology  
Mouth and Tongue  
Tonsils  
Larynx  
Tracheotomy  
Thorax  
Cardiovascular Surgery  
Gall and Kidney  
Intestines, Stomach  
Urology  
Rectum  
Gynecology  
Obstetrics  
Dermatology, Hygiene  
Different Containers  
High Frequency Surgery

## Indice

03:	Diagnóstico
05:	Anestesia
07:	Bisturíes
09:	Tijeras
10:	Tijeras p/micro cirugía
11:	Pinzas de disección
12:	Pinzas p/micro cirugía Clamp Atrauma Bulldog
13:	Pinzas hemostáticas
15:	Pinzas de campo
17:	Pinzas p/tapones
19:	Separadores
21:	Sondas, Porta-algodón
23:	Trócares
25:	Porta-agujas
27:	Instrumentos para sutura
29:	Instrumentos para la esterilización
31:	Vendajes enyesados
33, 34:	Cirugía ósea
41:	Neurocirugía
43, 44:	Oftalmología
45:	Otología
47:	Rinología
49:	Boca y lengua
51:	Amígdalas
53:	Laringe
55:	Traqueotomía
57:	Tórax
61:	Cirugía cardiovascular
63:	Vesícula biliar
65:	Intestinos, Estómago
67:	Urología
69:	Recto
71:	Ginecología
73:	Obstetricia
75:	Dermatología, Higiene
89:	Contenedores varios
91:	Electrocirugía

## Index

Diagnostica
Anestesia
Bisturi
Forbici
Forbici per microchirurgia
Pinze per dissezione
Pinze per microchirurgia
Pinze Atrauma Bulldog
Pinze emostatiche
Pinze fissateli
Pinze per medicatura
Divaricatori
Sonde, Portacotone
Trequarti
Port'aghi
Strumenti per suture
Strumenti per la sterilizzazione
Bendaggi gessati
Chirurgia ossea
Neurochirurgia
Oftalmologia
Otologia
Rinologia
Bocca e lingua
Tonsille
Laringe
Tracheotomia
Torace
Chirurgia cardiovascolare
Vescicola biliare, rene
Intestini, Stomaco
Urologia
Retto
Ginecologia
Ostetrica
Dermatologia, Igiene
Vassoi diversi
Elettrochirurgia



## DIPLOMAT PRESAMETER

Preiswertes und sehr beliebtes Quecksilbergerät in Metallgehäuse. Lichtgraue Kunststoffbeschichtung. Glasröhre von höchster Präzision mit Innendurchmesser 4,2 mm +/- 0,2 mm. Gute Ablesbarkeit der eloxierten Skala bis 300 mmHg. Vernickelte Metallteile. Mit Quecksilbersicherung. Maximale Fehlertoleranz des Gerätes: +/- 3 mmHg. Mit Latexball und verchromtem Ablassventil.

**Nr. 03112-00 - Mit Wickelmanschette aus Baumwolle komplett mit Latexpolster 2-Schlauch.**

**Nr. 03112-01 - Mit Hakenmanschette aus Baumwolle komplett mit Latexpolster 2-Schlauch.**

**Nr. 03112-02 - Mit kalibrierter Nylon-Velcromanschette komplett mit Latexpolster 2-Schlauch.**

Economical and attractive mercurial sphygmomanometer in metal case. Enameled in light gray color. Precision glass tube with inside diameter 4,2 mm +/- 0,2 mm. Anodized faceplate with easy-to-read graduated scale. Maximum reading 300 mmHg. Nickel-plated metal parts. Mercury lock. Maximum error throughout range +/- 3 mmHg. Complete with latex bulb and chrome-plated air-release valve.

**No. 03112-00 - With cotton bandage cuff complete with 2-tube latex bladder.**

**No. 03112-01 - With cotton hook cuff complete with 2-tube latex bladder.**

**No. 03112-02 - With calibrated nylon velcro complete with 2-tube latex bladder.**

Tensiómetro de mercurio económico y de una gran difusión en estuche metálico. Recubierto con plástico de color gris claro. Tubo vidrio de máxima precisión con diámetro interior de 4,2 mm +/- 0,2 mm. Lectura cómoda en la escala anodizada hasta 300 mmHg. Partes metálicas niqueladas. Tiene cierre de seguridad en el depósito de mercurio. Tolerancia de errores máxima del aparato +/- 3 mmHg. Pera latex y válvula cromada.

**No. 03112-00 - Con brazaletes de venda de algodón, completo, bolsa latex de 2 tubos.**

**No. 03112-01 - Con brazaletes de ganchos de algodón, completo, con bolsa latex de 2 tubos.**

**No. 03112-02 - Con brazaletes velcro de nilón, calibrado, completo con bolsa latex de 2 tubos.**

Sfigmomanometro a mercurio economico ed elegante in astuccio di metallo. Verniciato in grigio chiaro. Colonna di precisione di vetro con diametro interno 4,2 mm +/- 2 mm. Quadrante anodizzato con scala graduata di facile lettura. Valore massimo 300 mmHg. Parti metalliche nichelate. Chiusura di sicurezza del mercurio. Tolleranza +/- 3 mmHg. Completo di monopalla in latex e valvola di sfiato cromata.

**No. 03112-00 - Con bracciale di cotone a fascia, completo di camera d'aria in latex a due tubi.**

**No. 03112-01 - Con bracciale di cotone a ganci, completo di camera d'aria in latex a due tubi.**

**No. 03112-02 - Con bracciale calibrato velcro-nylon completo di camera d'aria in latex a due tubi.**



Qualitativ sehr hochwertiges Quecksilbergerät in Metallgehäuse mit 2-farbiger Einbrennlackierung (hellgrau und schwarz). Glasröhre von höchster Präzision mit Innendurchmesser 4,2 mm +/- 0,2 mm. Gute Ablesbarkeit der eloxierten Skala bis 300 mmHg. Verchromte Metallteile. Mit Quecksilbersicherung und Ballhalterung. Maximale Fehlertoleranz des Gerätes: +/- 3 mmHg. Mit Latexball und verchromtem Ablaufventil.

**Nr. 03113-00 - Mit Wickelmanschette aus Baumwolle komplett mit Latexpolster 2-Schlauch.**

**Nr. 03113-01 - Mit Hakenmanschette aus Baumwolle komplett mit Latexpolster 2-Schlauch.**

**Nr. 03113-02 - Mit kalibrierter Nylon-Velcromanschette komplett mit Latexpolster 2-Schlauch.**

High quality extra-sturdy mercurial sphygmomanometer in metal case. Enamelled in light gray with contrasting trim. Precision glass tube with inside diameter 4,2 mm +/- 0,2 mm. Anodized faceplate with easy-to-read graduated scale. Maximum reading 300 mmHg. Chrome-plated metal parts. Mercury lock. Bulb holder. Maximum error throughout range +/- 3 mmHg. With latex bulb and chrome-plated air release valve.

**No. 03113-00 - With cotton bandage cuff complete with 2-tube latex bladder.**

**No. 03113-01 - With cotton hook cuff complete with 2-tube latex bladder.**

**No. 03113-02 - With calibrated nylon velcro complete with 2-tube latex bladder.**

Tensiómetro de mercurio de alta calidad en estuche metálico barnizado al fuego en gris claro y negro. Tubo vidrio de precisión máxima con diámetro interior de 4,2 mm +/- 0,2 mm. Cómoda lectura de la escala anodizada hasta 300 mmHg. Partes metálicas cromadas. El depósito de mercurio lleva un cierre de seguridad. Soporte para pera. Tolerancia de errores máxima del aparato +/- 3 mmHg. Con pera latex y válvula cromada.

**No. 03113-00 - Con brazalete de venda de algodón completo, con bolsa latex con 2-tubos.**

**No. 03113-01 - Con brazalete de ganchos de algodón completo, con bolsa latex con 2-tubos.**

**No. 03113-02 - Con brazalete velcro de nilón calibrado completo, con bolsa latex con 2-tubos.**

Sfigmomanometro a mercurio di alta qualità, molto robusto, in astuccio di metallo, verniciato in grigio chiaro con eleganti rifiniture. Colonna di precisione di vetro con diametro interno 4,2 mm +/- 2 mm. Quadrante anodizzato con scala graduata di facile lettura. Valore massimo 300 mmHg. Parti metalliche cromate. Chiusura di sicurezza del mercurio. Supporto per monopalla. Tolleranza +/- 3 mmHg. Con monopalla in latex e valvola di sfianto cromata.

**No. 03113-00 - Con bracciale di cotone a fascia completo di camera d'aria di latex a 2-tubi.**

**No. 03113-01 - Con bracciale di cotone a ganci completo di camera d'aria di latex a 2-tubi.**

**No. 03113-02 - Con bracciale calibrato velcro-nylon completo di camera d'aria di latex a 2-tubi.**

## NOVA WANDMODELL

Quecksilbergerät von höchster Qualität, ideal für Praxis und Klinik. Nicht schwenkbar. Lichtgrau kunststoffbeschichtete Metallplatte. Glasröhre von höchster Präzision mit Innendurchmesser 4,2 mm +/- 0,2 mm. Gute Ablesbarkeit der eloxierten Skala bis 300 mmHg. Verchromte Metallteile. Quecksilbersicherung. Kunststoffbeschichteter Metallkorb zur optimalen Aufbewahrung des Zubehörs. Spiralschlauch dehnbar bis zu 3 m. Maximale Fehlertoleranz des Gerätes: +/- 3 mmHg. Mit Latexball und verchromtem Ablaufventil. Befestigungsschrauben und Dübel werden mitgeliefert.

**Nr. 03114-00 - Mit Wickelmanschette aus Baumwolle komplett mit Latexpolster 2-Schlauch.**

**Nr. 03114-01 - Mit Hakenmanschette aus Baumwolle komplett mit Latexpolster 2-Schlauch.**

**Nr. 03114-02 - Mit kalibrierter Nylon-Velcromanschette komplett mit Latexpolster 2-Schlauch.**

High quality mercurial sphygmomanometer ideal for use in hospitals and physicians' offices. Non-swiveling metal housing enameled in light gray. Precision glass tube with inside diameter 4,2 mm +/- 0,2 mm. Anodized faceplate with easy-to-read graduated scale. Maximum reading 300 mmHg. Chrome-plated metal parts. Mercury lock. Plastic coated metal basket for convenient accessory storage. Coiled tubing extensible to 3 m. Maximum error throughout range +/- 3 mmHg. With latex bulb and chrome-plated air-release-valve. Mounting hardware included.

**No. 03114-00 - With cotton bandage cuff complete with 2-tube latex bladder.**

**No. 03114-01 - With cotton hook cuff complete with 2-tube latex bladder.**

**No. 03114-02 - With calibrated nylon velcro cuff complete with 2-tube latex bladder.**

Tensiómetro de mercurio de alta calidad y fiabilidad, ideal para consultorios y clínicas. Fijo, no movible. Placa metal recubierta plástico de color gris claro. Tubo vidrio de precisión máxima y diámetro interior de 4,2 mm +/- 0,2 mm. Cómoda lectura de la escala anodizada hasta 300 mmHg. Partes metálicas cromadas. Con cierre de seguridad en el depósito de mercurio.

Cestillo metálico recubierto de plástico para la colocación del accesorio. Con tubo espiral extensible hasta 3 metros. Tolerancia de errores máxima del aparato: +/- 3 mmHg. Con pera latex y válvula cromada. Se incluyen tacos y tornillos para la sujeción.

**No. 03114-00 - Con brazaletes de venda de algodón completo con bolsa latex con 2 tubos.**

**No. 03114-01 - Con brazaletes de ganchos de algodón completo con bolsa latex con 2 tubos.**

**No. 03114-02 - Con brazaletes velcro de nilón calibrado completo con bolsa latex con 2 tubos.**

Sfigmomanometro a mercurio di alta qualità, ideale per ospedali ed ambulatori. Corpo dell'apparecchio in metallo, non orientabile, verniciato in grigio chiaro. Colonna di precisione di vetro con diametro interno 4,2 mm +/- 0,2 mm. Quadrante anodizzato con scala graduata di facile lettura. Valore massimo 300 mmHg. Parti metalliche cromate. Chiusura di sicurezza del mercurio. Cestello porta accessori in metallo rivestito di plastica. Tubo a spirale estensibile fino a 3 m. Tolleranza +/- 3 mmHg. Con monopalla in latex e valvola di sfiato cromata. Fornito con accessori di montaggio.

**No. 03114-00 - Con bracciale di cotone a fascia completo di camera d'aria di latex a 2-tubi.**

**No. 03114-01 - Con bracciale di cotone a ganci completo di camera d'aria di latex a 2-tubi.**

**No. 03114-02 - Con bracciale calibrato velcro-nylon completo di camera d'aria di latex a 2-tubi.**





EXACTA-SPEZIAL

Noch modernere Ausführung unseres bisherigen sehr bekannten und beliebten Exacta Manometers. Sehr interessant im Preis. Metallgehäuse, schwarz einbrennlackiert. Mit spezialgehärteter Kupfer-Beryllium Membrane. Keine Nullpunktfixierung. Gut ablesbare Aluminiumskala  $\varnothing$  49 mm bis 300 mmHg. Metallklemme an der Rückseite des Manometers zum Einhängen an der Manschette. Mit Latexball und verchromtem Ablaßventil. In Vinyltasche mit Reißverschluss. Maximale Fehlertoleranz des Gerätes:  $\pm$  3 mm Hg.  
**No. 03120-00 - Mit kalibrierter Nylon-Velcromanschette komplett mit Latexpolster 2-Schlauch.**

Latest version of our well-known Exacta classic sphygmomanometer, with an especially attractive price. Metal housing with baked-on black enamel finish. Special tempered copper-beryllium diaphragm. No stop pin. Easy-to-read graduated aluminium scale 49 mm  $\varnothing$ . Maximum reading 300 mmHg. Clip on rear of manometer for attachment to cuff. With latex bulb and chrome-plated air release valve, in vinyl zipper case. Maximum error  $\pm$  3 mmHg throughout range.  
**No. 03120-00 - With calibrated nylon-velcro cuff complete with 2-tube latex bladder.**

Modelo más moderno que nuestro anterior Exacta manómetro muy popular y conocido. Con precio muy económico. Caja metálica barnizada al fuego de color negro. Con membrana cobreberilio endurecido especial. Sin fijación a cero. Buena lectura de la escala aluminio  $\varnothing$  49 mm hasta 300 mmHg. Con pinza metálica a la parte posterior del manómetro para ganchar en el brazalete. Con pera de latex y válvula cromada. En estuche de vinyl con cierre de cremallera. Tolerancia de errores máxima del aparato:  $\pm$  3 mmHg.  
**No. 03120-00 - Con brazalete velcro de nilón calibrado completo con bolsa de latex con 2 tubos.**

La più recente versione dei famosi sfigmomanometri tradizionali Exacta, ad un prezzo veramente interessante. Realizzato in metallo rifinitura smaltata a forno. Membrana speciale di rame-berillio indurito. Senza fissaggio a zero. Scala graduata in alluminio  $\varnothing$  49 mm di facile lettura. Valore massimo 300 mmHg. Con morsetto nella parte posteriore del manometro per l'attacco al bracciale. Monopalla di latex e valvola di sfiato cromata. Fornito in borsa di vinilpelle con cerniera lampo. Tolleranza  $\pm$  3 mmHg.  
**No. 03120-00 - Con bracciale calibrato velcro-nylon completo di camera d'aria di latex a 2 tubi.**





Sehr preisgünstiges, modernes und beliebtes Einhandmodell. Stabiles Kunststoffgehäuse, schwarz. Spezialgehärteter Kupfer-Beryllium Membrane. Keine Nullpunktfixierung. Gut ablesbare Aluminiumskala  $\varnothing$  63 mm bis 300 mmHg. Löffel aus rostfreiem Stahl. Mit Latexball und verchromtem Ablassventil. Mit verchromter Schlauchverschraubung auf der rechten Seite unterhalb des Manometers. In Vinyltasche mit Reißverschluss. Maximale Fehlertoleranz des Gerätes:  $\pm$  3 mmHg.

**Nr. 03122-00 - Mit kalibrierter Nylon-Velcromanschette komplett mit Latexpolster 1-Schlauch.**

Very attractive and economical modern palm-style sphygmomanometer. Black housing of engineering plastic with chrome-plated tube connection at lower right. Special tempered copper-beryllium diaphragm. No stop pin. Easy-to-read graduated aluminium scale  $\varnothing$  63 mm. Maximum reading 300 mmHg. Stainless steel handle. With latex bulb and chrome-plated air release valve, in vinyl zipper case. Maximum error  $\pm$  3 mmHg throughout range.

**No. 03122-00 - With calibrated nylon-velcro cuff complete with 1-tube latex bladder.**

Modelo de mano, muy económico, moderno y popular. Estuche plástico duro de color negro. Con membrana cobre-berilio endurecido especial. Sin fijación a cero. Buena lectura de la escala de aluminio  $\varnothing$  63 mm hasta 300 mmHg. Con cuchara de acero inoxidable. Con pera de latex y válvula cromada. Con atomilladura de tubo cromada al lado derecho debajo del manómetro. En estuche de vinil con cierre de cremallera. Tolerancia de errores máxima del aparato:  $\pm$  3 mmHg.

**No. 03122-00 - Con brazaletes velcro de nilón, calibrado, completo con bolsa de latex con 1 tubo.**

Sfigmomanometro molto elegante, moderno ed economico. Modello a mano. Scatola del manometro in materiale sintetico robusto con uscita laterale cromata per collegamento del tubo (in basso a destra). Membrana speciale in rame-berillio indurito. Senza fissaggio a zero. Scala graduata in alluminio di facile lettura,  $\varnothing$  63 mm. Valore massimo 300 mmHg. Manico in acciaio inossidabile. Con monopalla di latex, valvola di sfiato cromata. Fornito in borsa di vinilpelle con chiusura lampo. Tolleranza  $\pm$  3 mmHg.

**No. 03122-00 - Con bracciale calibrato velcro-nylon completo di camera d'aria di latex add 1 tubo.**

Blutdruckmeßgeräte  
Sphygmomanometer  
Esfigmomanómetros  
Sfigmomanometri



Einhandblutdruckmessgerät, besonders geeignet für Kinderarztpraxen. Wurde speziell in der kinderfreundlichen Farbe blau gestaltet. Verchromtes Metallgehäuse. Spezialgehärtete Kupfer-Beryllium Membrane. Keine Nullpunktfixierung. Gut ablesbare blau-weiße Aluminiumskala  $\varnothing$  49 mm bis 300 mmHg. Löffel aus rostfreiem Stahl. Blauer Weichkunststoffball und verchromtes Ablaufventil. Verchromte Schlauchverschraubung am Manometeroberteil. In blauer Kunstledertasche mit Reißverschluss. Maximale Fehlertoleranz:  $\pm$  3 mmHg. Komplet mit 3 verschiedenen blauen, kalibrierten Nylon-Velcro-Manschetten, mit Latexpolster 1-Schlauch. Alle Manschetten werden mit besonders kinderfreundlichem Bärendruck geliefert.

**Nr. 03126-00 - Komplettes Set mit 3 austauschbaren Manschetten mit Metallkonnektoren.**  
Neugeborene: 15,5 x 5,0 cm - Säuglinge: 23,0 x 7,2 cm - Kinder: 35,5 x 10,0 cm

Modern palm-model sphygmomanometer specially designed for pediatric use. Interchangeable cuffs equipped with metal tube connectors for quick and reliable attachment to unit of cuff appropriate to age of patient. Scale, bulb, cuffs, and case in attractive light blue color, with cuffs printed with child-friendly bear motif. Chrome-plated metal housing with tube connection at top. Stainless steel handle. Special tempered copper-beryllium diaphragm. No stop pin. Easy-to-read graduated manometer scale  $\varnothing$  49 mm. Maximum reading 300 mmHg. With soft plastic bulb, chrome-plated air-release valve, and set of three interchangeable cuffs, in leatherette zipper case. Maximum error  $\pm$  3 mmHg throughout range.

**No. 03126-00 - Complete with set of three interchangeable cuffs with metal connectors.**  
Newborn: 15,5 x 5,0 cm - Infant: 23,0 x 7,2 cm - Child: 35,5 x 10,0 cm

Tensiómetro a mano, apropiado especialmente p. consultorios de pediatra. Se fabrica en color azul, agradable p. niños. Estuche metálico cromado. Membrana cobre-berilio endurecido especial. Sin fijación a cero. Buena lectura de la escala aluminio de colores azul y blanco  $\varnothing$  49 mm hasta 300 mmHg. Cuchara de acero inoxidable. Pera de hule de plástico suave azul. Válvula cromada. Atornilladura de tubo cromada a la parte superior del manómetro. En estuche de cuero artificial, azul. c. cierre de cremallera. Tolerancia de errores máxima:  $\pm$  3 mmHg. 3 brazaletes velcro de nilón, calibrados, con bolsas latex, 1 tubo de tamanos diferentes de color azul. Los tres brazaletes llevan impreso unos osos especialmente atractivo p. niños.

**No. 03126-00 - Juego, completo con 3 brazaletes intercambiados con conectores metálicos.**  
Recien nacidos: 15,5 x 5,0 cm - Lactantes: 23,0 x 7,2 cm - Niños: 35,5 x 10,0 cm

Sfigmomanometro moderno, modello a mano, per uso pediatrico. Bracciali intercambiabili correati di connettori di metallo per un veloce e sicuro attacco all'apparecchio del bracciale più adatto all'età del paziente. Scala graduata, monopalla, bracciali e astuccio di colore azzurro. Bracciali con stampato motivo adatto per bambini. Manometro cromato con uscita per collegamento tubo nella parte superiore. Manico in acciaio inossidabile. Membrana speciale in rame-berillio indurito. Senza fissaggio a zero. Scala graduata del manometro  $\varnothing$  49 mm di facile lettura. Valore massimo 300 mmHg. Monopalla in plastica morbido, valvola di sfianto cromata e set di 3 bracciali intercambiabili in astuccio di finta pella con cerniera lampo. Tolleranza  $\pm$  3 mmHg.

**Nr. 03126-00 - Comprende set di 3 bracciali intercambiabili con raccordi di metallo.**  
Neonati: 15,5 x 5,0 cm - Bambini piccoli: 23,0 x 7,2 cm - Bambini: 35,5 x 10,0 cm



## MINIMUS II

Weltweit bekanntes und überaus beliebtes Einhandmodell. Verchromtes Metallgehäuse. Spezialgehärtete Kupfer-Beryllium Membrane. Keine Nullpunktfixierung. Gut ablesbare Aluminiumskala  $\varnothing$  49 mm bis 300 mmHg. Löffel aus rostfreiem Stahl. Mit Latexball und verchromtem Ablassventil. Mit verchromter Schlauchverschraubung am Manometeroberteil. In Vinyltasche mit Reißverschluss. Maximale Fehlertoleranz des Gerätes:  $\pm$  3 mmHg.

**Nr. 03132-00 - Mit Wickelmanschette aus Baumwolle komplett mit Latexpolster 1-Schlauch.**

**Nr. 03132-01 - Mit Hakenmanschette aus Baumwolle komplett mit Latexpolster 1-Schlauch.**

**Nr. 03132-02 - Mit kalibrierter Nylon-Velcromanschette komplett mit Latexpolster 1-Schlauch.**

World-famous palm-style aneroid sphygmomanometer. Chrome-plated metal housing. Special tempered copper-beryllium diaphragm. No stop pin. Easy-to-read graduated aluminum scale 49 mm  $\varnothing$ . Maximum reading 300 mmHg. Stainless steel handle. With latex bulb and chrome-plated air release valve. In vinyl zipper case. Maximum error  $\pm$  3 mmHg throughout range.

**No. 03132-00 - With cotton bandage cuff, complete with 1-tube latex bladder.**

**No. 03132-01 - With cotton hook cuff, complete with 1-tube latex bladder.**

**No. 03132-02 - With calibrated nylon-velcro cuff, complete with 1-tube latex bladder.**

Modelo de mano, de fama mundial y preferido por los medicos. Caja metálica cromada donde se aloja el mecanismo. Con membrana cobre-berilio endurecido especial. Sin fijación a cero. Buena lectura de la escala de aluminio  $\varnothing$  49 mm hasta 300 mmHg. Con cuchara de acero inoxidable. Con pera latex y válvula cromada. Con atornilladura de tubo cromada a la parte superior del manómetro. En estuche de vinilico con cierre de cremallera. Tolerancia máxima del aparato:  $\pm$  3 mmHg.

**No. 03132-00 - Con brazaletes de venda de algodón completo con bolsa de latex con 2 tubos.**

**No. 03132-01 - Con brazaletes de ganchos de algodón completo con bolsa de latex con 2 tubos.**

**No. 03132-02 - Con brazaletes velcro de nilón calibrado completo con bolsa de latex con 2 tubos.**

Sfigmomanometro ad aneroido, modello a mano di fama mondiale. Manometro cromato con uscita per collegamento tubo cromata, nella parte superiore. Membrana speciale di rame-berillio indurito. Senza fissaggio a zero. Scala graduata in alluminio  $\varnothing$  49 mm di facile lettura. Valore massimo 300 mmHg. Manico in acciaio inossidabile. Con monopalla di latex e valvola di sfiato cromato. Fornito in borsa vinilpelle con cerniera lampo. Tolleranza  $\pm$  3 mmHg.

**No. 03132-00 - Con bracciale di cotone a fascia completo di camera d'aria latex ad 1 tubo.**

**No. 03132-01 - Con bracciale di cotone a ganci completo di camera d'aria di latex ad 1 tubo.**

**No. 03132-02 - Con bracciale calibrato velcro-nylon completo di camera d'aria di latex ad 1 tubo.**

Blutdruckmeßgeräte  
Sphygmomanometer  
Esfigmomanómetros  
Sfigmomanometri



MINIMUS III

Weltweit bekanntes und beliebtes Einhandmodell. Verchromtes Metallgehäuse. Spezialgehärtete Kupfer-Beryllium Membrane. Keine Nullpunktfixierung. Gut ablesbare Aluminiumskala  $\varnothing$  49 mm bis 300 mmHg. Löffel aus rostfreiem Stahl. Latexpolster und verchromtes Ablaufventil. Zwei verchromte Schlauchverschraubungen an der rechten Seite unterhalb des Manometers. In Vinyltasche mit Reißverschluss. Maximale Fehlertoleranz des Gerätes:  $\pm$  3 mmHg.

**Nr. 03133-00 - Mit Wickelmanschette aus Baumwolle, komplett mit Latexpolster mit Doppelschlauch.**

**Nr. 03133-01 - Mit Hakenmanschette aus Baumwolle, komplett mit Latexpolster mit Doppelschlauch.**

**Nr. 03133-02 - Mit kalibrierter Nylon-Velcromanschette, komplett mit Latexpolster mit Doppelschlauch.**

World-famous and popular palm-style sphygmomanometer. Chrome-plated metal housing with 2 chromed-tube connections at lower right. Special tempered copper-beryllium diaphragm. No stop pin. Easy-to-read graduated aluminium scale  $\varnothing$  49 mm. Maximum reading 300 mmHg. Stainless steel handle. With latex bulb and chrome-plated air release valve. In vinyl zipper case. Maximum error  $\pm$  3 mmHg throughout range.

**No. 03133-00 - With cotton bandage cuff, complete with double-tube latex bladder.**

**No. 03133-01 - With cotton hook cuff, complete with double-tube latex bladder.**

**No. 03133-02 - With calibrated nylon velcro cuff complete with double-tube latex bladder.**

Modelo de mano, conocido en el mundo entero y de gran aceptación. Caja metálica cromada donde se aloja el mecanismo. Membrana cobre-berilio endurecido especial. Sin fijación a cero. Buena lectura de la escala aluminio  $\varnothing$  49 mm hasta 300 mmHg. Cuchara de acero inoxidable. Pera latex y válvula cromada. Dos atornilladuras de tubo cromadas al lado derecho debajo del manómetro. En estuche vinilo con cierre de cremallera. Tolerancia de errores máxima:  $\pm$  3 mmHg.

**No. 03133-00 - Con brazalete de venda de algodón, completo con bolsa de latex doble tubos.**

**No. 03133-01 - Con brazalete de ganchos de algodón, completo con bolsa de latex doble tubos.**

**No. 03133-02 - Con brazalete velcro de nilón calibrado, completo con bolsa de latex doble tubos.**

Sfigmomanometro ad aneroide di fama mondiale. Manometro in metallo cromato con uscita cromata laterale (in basso a destra) per collegamento a due tubi. Membrana speciale di rame-berillio indurito. Senza fissaggio a zero. Scala graduata in alluminio  $\varnothing$  49 mm di facile lettura. Valore massimo 300 mmHg. Manico in acciaio inossidabile. Con monopalla di latex e valvola di sfianto cromata. Fornito in borsa vinilpelle con cerniera lampo. Tolleranza  $\pm$  3 mmHg.

**No. 03133-00 - Con bracciale di cotone a fascia, completo di camera d'aria di latex a 2 tubi.**

**No. 03133-01 - Con bracciale di cotone a ganci, completo di camera d'aria di latex a 2 tubi.**

**No. 03133-02 - Con bracciale calibrato velcro-nylon completo di camera d'aria a 2 tubi.**

Diagnostik-Bestecke mit Standardbeleuchtung  
Diagnostic Sets with Standard illumination  
Estuches de diagnóstico con iluminación standard  
Combinazioni per diagnostica con illuminazione standard



**Nr. 03161-00**

Weltbekanntes und preiswertes Otoskop mit Standardbeleuchtung 2,5 V. Besonders geeignet für Studenten und Ärzte.

Set bestehend: Aus **Otoskopkopf** verchromt, mit Steckverschluß. **Verchromter Batteriegriff 28 mm Ø** für 2 Batterien Typ C. Mit abnehmbarem Abdeckglas in Kunststoff-Fassung mit Plastikconnector für den pneumatischen Test. Die verchromte Schwenklinse ist abnehmbar und vergrößert 4,0-fach. Die Lichtstärke kann anhand des Rheostates reguliert werden. Mit 3 wiederverwendbaren Ohrtrichtern 2, 3 und 4 mm Ø. Komplett in silberfarbener Kunststofftasche.

**No. 03161-00**

World famous otoscope set at a budget price for physicians and students. 2,5 V standard illumination for use with 2 batteries type C.

Set includes: **Otoscope head** with pin contact fitting. Chrome-plated. Fixed protective lens in plastic mount may be removed for introduction of instruments. Plastic connector for pneumatic otoscopy. Removable swivel-mounted 4 x magnifier. 2, 3 and 4 mm reusable specula included. **Battery handle 28 mm Ø** for 2 C-cell batteries. Chrome-plated. With thumb wheel for securing pin contact heads. With rheostat for adjustment of illumination. Complete in silver-colored plastic pouch.

**No. 03161-00**

Otoscopio muy popular y económico con iluminación standard 2,5 V apropiado para estudiantes y médicos, de fama mundial.

**Cabeza otoscopio cromada**, con cierre de tornillo. **Mango a pilas cromado 28 mm Ø** para dos pilas tipo C. Con cristal de cubierto desmontable en armadura plástica. Con conector plástico para el test neumático. La lente giratoria es desmontable y amplifica 4,0 veces mas. La intensidad de la luz es regulable con el reostato. Con tres espejos reutilizables 2, 3 y 4 mm Ø. Completo en bolsa de plástico de color gris plata.

**No. 03161-00**

Combinazione otoscopio molto conosciuta, ad un prezzo economico, per ambulatori e studenti. Illuminazione standard 2,5 V con 2 batterie tipo C.

La combinazione comprende: **Testa otoscopio** con chiusura a vite. Cromata. La lente di protezione fissa in supporto di plastica può essere tolta per l'inserimento di strumenti. Connettore di plastica per test pneumatico. Lente d'ingrandimento 4 x in montatura girevole estraibile. Inclusi specoli riusabili da 2, 3 e 4 mm. **Manico a pila Ø 28 mm** per 2 batterie tipo C. Cromato. Con ruota ad orlo zigrinato per fissare la testa dell'otoscopio con chiusura a vite. Con reostato per la regolazione dell'illuminazione. Fornito in busta di plastica colore grigio argento.

Diagnostik-Bestecke mit Standardbeleuchtung  
Diagnostic Sets with Standard illumination  
Estuches de diagnóstico con iluminación standard  
Combinazioni per diagnostica con illuminazione standard



UNI II

**Nr. 03161-01**

Weltbekanntes und preisgünstiges **May-Ophthalmoskop**: mit Standardbeleuchtung 2,5 V. Besonders für Studenten und Ärzte geeignet. Ophthalmoskop mit Steckverschluß. Anhand des Linsenrades können Korrekturlinsen von 0 bis +20 und 0 bis -20 Dioptrien gewählt werden. Mit einer Blende: großer Kreis. Mit verchromtem **Batteriegriff**: 28 mm ø für 2 Batterien Typ C. Die Lichtstärke kann anhand des Rheostates reguliert werden. Komplett in silbergrauer Kunststofftasche.

**No. 03161-01**

World-famous ophthalmoscope set at a budget price for physicians and students. 2.5 V standard illumination for use with 2 batteries Type C. Set includes: **May ophthalmoscope head**: Pin contact fitting. Lens selection wheel permits choice of corrective lenses from 0 to +20 and 0 to -20 diopters. Single large circle aperture. **Battery handle**: 28 mm ø for 2 C-cell batteries. Chrome-plated. With thumb wheel for securing pin-contact heads. Rheostat for adjustment of illumination. Complete in silver-gray plastic pouch.

**No. 03161-01**

**Oftalmoscopio May**: muy popular y económico con iluminación standard 2,5 V, apropiado para estudiantes y médicos de fama mundial. Oftalmoscopio con cierre de tornillo. Con ayuda de la rueda de lentes se puede elegir lentes de corrección de 0 a +20 y 0 a -20 dioptrías. Y con una apertura: gran círculo. Con **mango a pilas**: cromado 28 mm ø para dos pilas tipo C. La intensidad de la luz es regulable con el reostato. Completo en bolsa de plástico de color gris plata.

**No. 03161-01**

Combinazione oftalmoscopio molto conosciuta, a prezzo economico, per ambulatori e studenti. Illuminazione standard 2,5 V con 2 batterie tipo C. La combinazione comprende: **Oftalmoscopio di May**: Con chiusura a vite. La rotella di selezione delle lenti permette la scelta di lenti di correzione da 0 a +20 e da 0 a -20 diottrie. Apertura singola a cerchio grande. **Manico a pila**: ø 28 mm per 2 batterie tipo C. Cromato. Con ruota ad orlo zigrinato per fissare la testa dell'otoscopio con chiusura a vite. Reostato per la regolazione dell'illuminazione. Fornito con busta di plastica di colore grigio argento.

Diagnostik-Bestecke mit Standardbeleuchtung  
Diagnostic Sets with Standard illumination  
Estuches de diagnóstico con iluminación standard  
Combinazioni per diagnostica con illuminazione standard



**Nr. 03161-02**

Weltbekanntes diagnostisches Besteck mit Standardbeleuchtung 2,5 V. Äußerst beliebt und sehr preiswert. Besonders geeignet für Studenten und Ärzte. Das Set besteht aus folgenden Teilen: **Otoskopkopf** verchromt, mit Steckverschluss. Abnehmbares Abdeckglas in Kunststofffassung, mit Plastikconnector für pneumatischen Test. Abnehmbarer Schwenklinse (Vergrößerung 4,0-fach). 3 wiederverwendbaren Ohrtrichtern 2, 3 und 4 mm  $\varnothing$ . **May-Ophthalmoskop** mit Steckverschluss. Anhand des Linsenrades können Korrekturlinsen von 0 bis +20 und 0 bis -20 Dioptrien gewählt werden. Mit einer Blende: großer Kreis. **Batteriegriff** verchromt, 28 mm  $\varnothing$  für 2 Batterien Typ C. Die Lichtstärke kann anhand des Rheostates am Batteriegriff reguliert werden. Alle Teile komplett in silbergrauer Kunststofftasche.

**No. 03161-02**

World-famous otoscope/ophthalmoscope diagnostic set at a budget price for physicians and students. 2,5 V Standard illumination for use with 2 batteries type C. Set includes: **Otoscope head** - Pin contact fitting. Chrome-plated. Fixed protective lens in plastic mount may be removed for introduction of instruments. Plastic connector for pneumatic otoscopy. Removable swivel-mounted 4 x magnifier. 2, 3 and 4 mm reusable specula included. **May ophthalmoscope head**. Pin contact fitting. Lens selection wheel permits choice of corrective lenses from 0 to +20 and 0 to -20 diopters. Single large circle aperture. **Battery handle**. 28 mm  $\varnothing$  for 2 C-cell batteries. Chrome-plated. With thumb wheel for securing pin-contact heads. Rheostat for adjustment of illumination.

**No. 03161-02**

Este estuche de diagnóstico con iluminación standard 2,5 V es muy popular y muy económico, apropiado para estudiantes y médicos. Juego, compuesto de: **Cabeza otoscopio** cromado, con cierre de tornillo. Con cristal de cubierto en armadura plástica, con conector plástico para el test neumático. Con lente giratorio desmontable (amplificación: 4 veces más). **Cabeza oftalmoscopio May** con cierre de tornillo. Con ayuda de la rueda de lentes se puede elegir lentes de corrección de 0 a +20 y 0 a -20 dioptrías. Con una apertura: gran círculo. **Mango a pilas** cromado, 28 mm  $\varnothing$  para dos pilas tipo C. La intensidad de la luz es regulable con el reostato al tope del mango. Todos los partes se presentan en una bolsa plástica de color gris plata.

**No. 03161-02**

Combinazione per diagnostica otoscopio/oftalmoscopio a prezzo economico, per ambulatori e studenti. Illuminazione standard 2,5 V con 2 batterie tipo C. La combinazione comprende: **Testa otoscopio** - Chiusura a vite. Cromata. La lente di protezione fissa in supporto di plastica può essere tolta per l'inserimento di strumenti. Connettore di plastica per test pneumatico. Lente d'ingrandimento 4 x in montatura girevole estraibile. Inclusi specoli da 2, 3 e 4 mm riusabili. **Oftalmoscopio May**. Chiusura a vite. La rotella di selezione permette la scelta di lenti di correzione da 0 a +20 e da 0 a -20 diottrie. Apertura singola a cerchio grande. **Manico a pila**  $\varnothing$  28 mm con 2 batterie tipo C. Cromato. Con ruota ad orlo zigrinato per fissare la testa dell'otoscopio con chiusura a vite. Reostato per la regolazione dell'illuminazione. Fornita in busta di plastica colore grigio argento.

Diagnostik-Bestecke mit Halogenbeleuchtung  
 Diagnostic Sets with Halogen illumination  
 Estuches de diagnóstico con iluminación halógena  
 Combinazioni per diagnostica con illuminazione alogena



Kleine, sehr moderne Qualitätsinstrumente aus Kunststoff, grau, mit Halogenbeleuchtung 2,5 V. Sehr preiswert und aufgrund der Größe besonders gut für die Arzttasche geeignet. Schraubverschluss. **Otoskop:** Fiber-Optik. Anschluß für pneumatischen Test. Lupe vergrößert 2,5-fach. Batteriegriff für 2 Batterien Typ AA. **Ophthalmoskop:** Korrekturlinsen: 0 bis +20 und 0 bis -20 Dioptrien. Blenden: Kreis groß + klein, Halbkreis, Fixierstern und Grünfilter. Griff für 2 Batterien Typ AA. Das Otoskop- und das Otoskop/Ophthalmoskop-Besteck werden jeweils mit einem Metallkonnektor für pneumatischen Test und Plastikröhrchen mit jeweils 5 wiederverwendbaren Ohrtrichtern 2,5 und 4,0 mm geliefert. Komplett in modernem schwarzen Kunststoffetui.

- Nr. 03171-00 - Otoskop mit Griff AA.**
- Nr. 03171-01 - Ophthalmoskop mit Griff AA.**
- Nr. 03171-02 - Otoskop/Ophthalmoskop jeweils mit Griff AA.**

Economically priced state-of-the-art quality instrument made of plastics, gray color, with halogen illumination 2.5 V. Due to its small size it is most suitable for each practitioner's bag. **Otoscope:** Fiber optic. Screw type fitting. 2.5 x magnifying glass. Battery handle for 2 AA-cell batteries. **Ophthalmoscope:** Corrective lenses ranging from 0 to +20 and 0 to -20 diopters. Apertures: large and small circle, semi-circle, fixation star and green filter. Otoscope and otoscope/ophthalmoscope set each contain a metal connector for pneumatic otoscopy as well as plastic tube with 5 each reusable ear specula 2.5 and 4.0 mm. All sets come in modern black plastic case.

- No. 03171-00 - Otoscope with AA-handle.**
- No. 03171-01 - Ophthalmoscope with AA-handle.**
- No. 03171-02 - Otoscope/ophthalmoscope with 1 each AA-handle.**

Instrumentos de calidad, muy moderno y pequeño de plástico resistente, gris, con iluminación halógena 2,5 V. Muy económico y gracias al tamaño apropiado para el bolsillo del médico. Cierre roscado. **Otoscopio:** fibra óptica. Conexión para test neumático. Lupa aumenta 2,5 veces más. Mango a pilas para 2 pilas, tipo AA. **Oftalmoscopio:** Lentes de corrección: 0 hasta +20 y o hasta -20 dioptrías. Aberturas: círculo grande y pequeño, semicírculo, estrella fijadora y filtro verde. Con mango para 2 pilas, tipo AA. Juego de otoscopio y de otoscopio/oftalmoscopio con conector metálico para el test neumático y con 5 especúlos reutilizables de 2,5 y 4,0 mm en tubo de plástico. Todos los juegos se presentan en estuche de plástico negro moderno.

- No. 03171-00 - Otoscopio con mango AA.**
- No. 03171-01 - Oftalmoscopio con mango AA.**
- No. 03171-02 - Oto/Oftalmoscopio con mangos AA.**

Strumento piccolo, moderno, di alta qualità realizzato in plastica, grigio, con illuminazione alogena 2,5 V. Molto economico e, date le sue dimensioni, il più adatto a stare nella borsa del medico. **Otoscopio:** con attacco a vite. Lente d'ingrandimento 2,5X. Manico a pila per 2 batterie tipo AA. **Oftalmoscopio:** Lenti correttive da 0 a +20 e da 0 a -20 diottrie. Aperture: a cerchio grande e piccolo, semicerchio, a stella, filtro verde. Con manico per 2 batterie tipo AA. L'otoscopio e la combinazione otoscopio/oftalmoscopio hanno un connettore per test pneumatico e tubo di plastica con 5 specoli auricolari 2,5 e 4,0 mm. cad. Tutte le combinazioni sono fornite in un moderno astuccio di plastica nera.

- No. 03171-00 - Otoscopio con manico AA.**
- No. 03171-01 - Oftalmoscopio con manico AA.**
- No. 03171-02 - Oto/Oftalmoscopio con manici AA.**



Nystagmusbrille  
Nystagmus spectacles  
Anteojos para nistagmo  
Occhiali nistagmo



## FRENZEL

03167-03  
Beleuchtete Nystagmusbrille  
mit querliegendem  
Batteriehandgriff und festen  
Gläsern

Energiequelle:  
2 Stück 4-Volt-Lämpchen  
2 Stück Baby-Zellen 1.5 V

03167-03  
Anteojos para nistagmo, con  
iluminación, con mango para  
pilas en forma horizontal,  
vidrios fijos,

Alimentación:  
2 unidades de bombillos de  
4 voltios  
2 unidades de pilas de  
1.5 voltios

03167-03  
Nystagmus spectacles for  
observation of the eyes during  
examination of the vestibular  
apparatus, with battery handle  
and fixed glasses. Illuminated  
on inside of lenses.

Source of energy:  
2 bulbs 4-volt  
2 baby-battery cells 1.5 V

03167-03  
Occhiali Nistagmo illuminati  
con manipo a batteria,  
lenti fisse.  
Per la rilevazione della reazione  
patologica del nistagmo.

Alimentazione:  
2 lampadine 4 Volt  
2 batterie 1,5 Volt

Stirnlampen  
Head Lights  
Lámparas frontales  
Lampade frontali



03180-94



03180-93



ZIEGLER  
03180-90  
compl.



03180-92

03180-90  
Ziegler-Stirnspiegel,  
komplett, mit schwarzem  
Stirnreifen,  
mit Kugelgelenk,  
90 mm ø

03180-90  
Ziegler Head Mirror,  
complete with black head  
band, with ball socket,  
90 mm ø

03180-90  
Ziegler espejo frontal, com-  
pleto con cinta negra,  
con articulación,  
90 mm ø

03180-90  
Specchio frontale, Ziegler,  
completo con fascia nera,  
con snodo sferico,  
90 mm di ø

03180-92  
Stirnreifen, allein

03180-92  
head band, only

03180-92  
cinta, suelta

03180-92  
fascia, sola

03180-93  
Spiegel, allein  
90 mm ø

03180-93  
Mirror, only  
90 mm ø

03180-93  
Espejo, suelto  
90 mm ø

03180-93  
Specchio,  
solo 90 mm ø

03180-94  
Gelenk für Stirnreifen

03180-94  
Socket joint for head bands  
only

03180-94  
Articulación para cintas fron-  
tales suelta

03180-94  
Snodo sferico per fascie  
frontali

Stirnlampen  
 Head Lights  
 Lámparas frontales  
 Lampade frontali



03195-00  
**CLAR**

komplett mit Stirnstreifen und Kabel  
 complete with head band and cable  
 completo con cinta frontal y cable  
 completa con fascia frontale e cordone



03195-01

Spiegel aus Glas ohne Fassung  
 Glass Mirror without frame  
 Reflector de cristal, sin montura  
 Riflettore di cristallo, senza montatura



03195-06  
 6 Volt



03195-07 Kleintransformator  
 220 Volt = 0 - 10 Volt / 3 Watt  
 Mini-Transformer Unit  
 Transformador eléctrico pequeño  
 Mini-trasformatore elettrico

03195-08 Kleintransformator  
 110 Volt = 0 - 10 Volt / 3 Watt  
 Mini-Transformer Unit  
 Transformador eléctrico pequeño  
 Mini-trasformatore elettrico

03195-09 Clar-Spiegel-Gelenkverbindung  
 Clar special socket joint  
 Articulación especial de Clar  
 Snodo speciale di Clar

03195-04 Stirnstreifen, alleine  
 head band, only  
 cinta frontal, suelta  
 fascia frontale, sola

03195-10 Clar Kopfspange allein aus Metall  
 mit Kabellaschen und  
 Fixierschraube mit Gelenk  
 Clar spring metal head band only,  
 with cable clips and fixing screw  
 with socket joint  
 Casco frontal de resorte metálico  
 suelto de Clar, con bridas de  
 cable, y tornillo de sujeción con  
 articulación  
 Fascia metallica a casco di Clar,  
 solo, con portacordoni e vite di  
 fissaggio a snodo

Stethoskope  
Stethoscopes  
Estetoscopios  
Stetoscopi

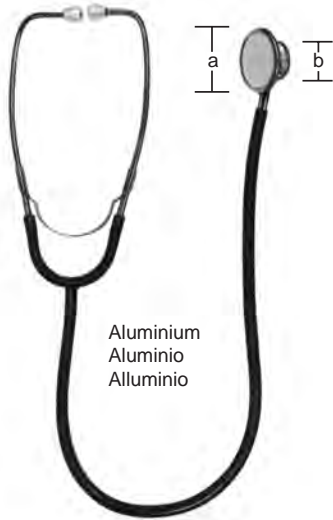

Aluminium  
Aluminio  
Alluminio

DUPLEX

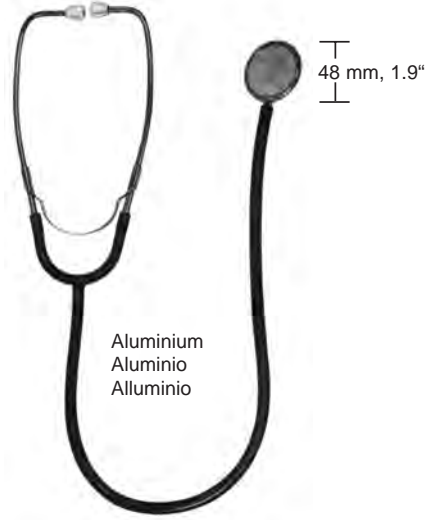

Aluminium  
Aluminio  
Alluminio

ANESTOPHON  
03248-00

	a	b	
03246-00	48 mm, 1.9"	30 mm, 1.2"	
03246-01	39 mm, 1.5"	25 mm, 1.0"	Baby
03246-02	21 mm, 0.8"	21 mm, 0.8"	Neonatal



PINARD  
03260-15 15 cm, 6"  
ALU



PINARD  
03262-18 18 cm, 7"  
Holz, wood,  
madera, legno

Perkussionshämmer  
 Percussion Hammers  
 Martillos de percusión  
 Martelli da percussione



TAYLOR - USA Mod.  
 03288-17 17 cm, 6 3/4"  
 03288-20 20 cm, 8"



BABINSKY  
 03292-22 22 cm, 8 3/4"



TROEMNER  
 03294-24 24 cm, 9 1/2"



DEJERINE  
 03304-20 20 cm, 8"



BERLINER  
 03306-17 17 cm, 6 3/4"



BUCK  
 03308-18 18 cm, 7"

Prüf- und Meßinstrumente  
 Examination and Measuring Instruments  
 Instrumentos para exámenes y medidas  
 Strumenti per esaminare e misurare

Dynamometer  
 Dynamometer  
 Dinamómetro  
 Dinamometro



COLLIN  
 03310-01 Erwachsene, Adult,  
 adultos, adulti  
 03310-02 Kind, child, niños, bambini

Winkelmesser  
 Goniometer  
 Goniómetro  
 Goniometro



MOELTGEN  
 03312-01



Finger-Goniometer  
 Finger goniometer  
 Goniómetro para dedos  
 Goniometro per le dita  
 03314-01



WARTENBERG  
 03320-19 19 cm, 7 1/2"



aus Stahl  
 of steel  
 de acero  
 di acciaio  
 03350-15 1,5 m 0.6"

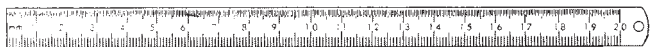

Metall  
 03340-10 10 cm 4"  
 03340-15 15 cm 6"  
 03340-20 20 cm 8"  
 03340-30 30 cm 12"  
 03340-50 50 cm 20"

Schieblehren  
Calipers  
Calibres  
Calibro

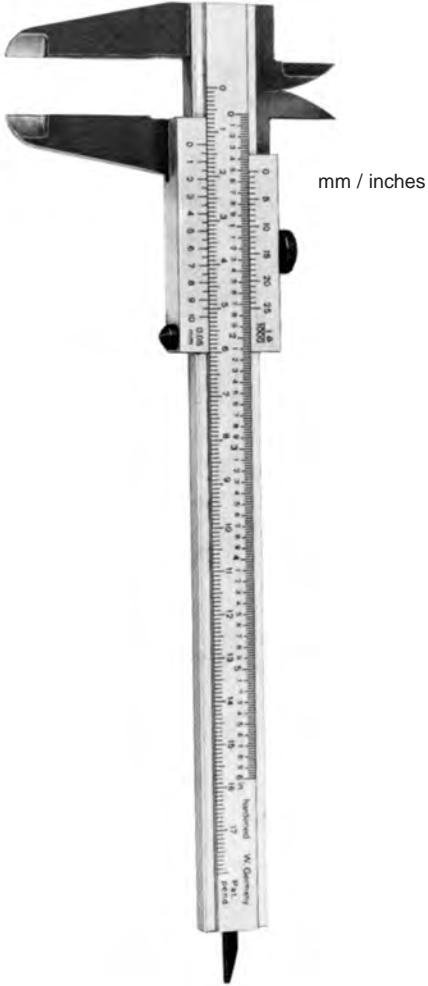

03360-21  
21 cm, 8 1/4"

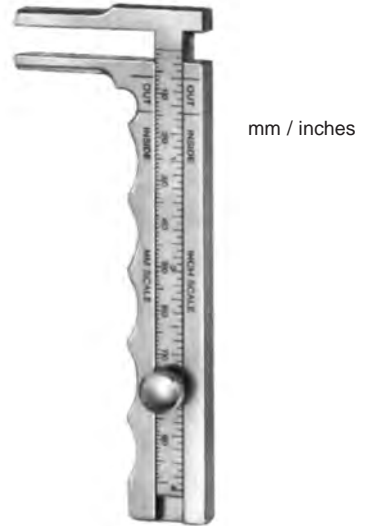

TOWNLEY  
03361-10  
11,5 cm, 4 1/2"

Saugrohre  
 Suction tubes  
 Tubos de aspiración  
 Cannule per aspirazione



POOLE 20 cm, 8"  
 05130-05 5.5 mm ø, 0.2"  
 (17 Fr.)

05130-10 10 mm ø, 0.4"  
 (30 Fr.)



POOLE 19 cm, 7 1/2"  
 05140-05 5.5 mm ø, 0.2"  
 (17 Fr.)

05140-08 8 mm ø, 0.3"  
 (23 Fr.)



compl. BABY-YANKAUER  
 05150-21 21 cm, 8 1/4"

compl. YANKAUER  
 05150-27 27 cm, 10 1/2"



Saugrohre  
Suction tubes  
Tubos de aspiración  
Cannule per aspirazione

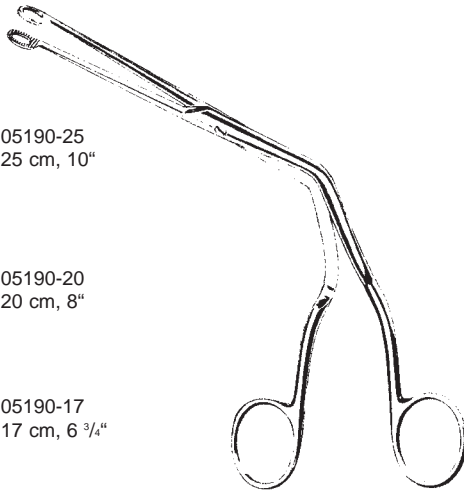
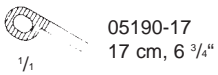
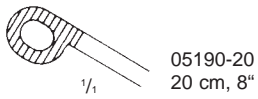
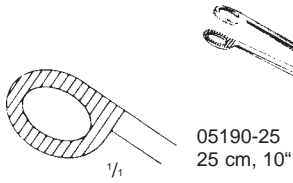

MAGILL



ANDREW-PYNCHON  
05170-24  
6 mm ø, 1/2"  
24 cm  
9 1/2"

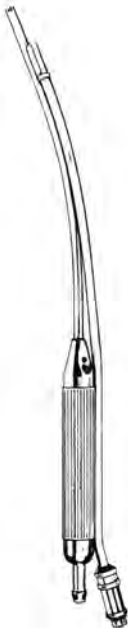

COOLEY  
05160-01  
8 mm ø, 0.3" / 36 cm, 14 1/4"  
mit Kaltlicht  
with cold-light  
con luz fria  
con luce fredda



COOLEY  
05160-02  
8 mm ø, 0.3"  
36 cm  
14 1/4"



COOLEY  
05160-03  
8 mm ø, 0.3"  
30 cm  
11 3/4"



DE BAKLEY  
05160-04  
3 mm Ø, 0.1"  
27 cm  
10 1/2"



McINTOSH

Fig. 0	5,5 cm	2 1/4"	05210-00
Fig. 1	7,5 cm	3"	05210-01
Fig. 2	9,0 cm	3 1/2"	05210-02
Fig. 3	11,0 cm	4 3/8"	05210-03
Fig. 4	13,5 cm	5 1/4"	05210-04

Cold light  
 05211-00  
 05211-01  
 05211-02  
 05211-03  
 05211-04



05239-03  
 Halogen-Lampe  
 Halogen Lamp  
 Lámpara Halógena  
 Lampada Alogena



05239-01  
 f./p. Fig. 0-1



05239-02  
 f./p. Fig. 2-4



FOREGGER

Fig. 0	5,5 cm	2 1/4"	05220-00
Fig. 1	7,0 cm	2 3/4"	05220-01
Fig. 2	9,0 cm	3 1/2"	05220-02
Fig. 3	11,0 cm	4 3/8"	05220-03
Fig. 4	13,5 cm	5 1/4"	05220-04

Cold light  
 05221-00  
 05221-01  
 05221-02  
 05221-03  
 05221-04



05239-03  
 Halogen-Lampe  
 Halogen Lamp  
 Lámpara Halógena  
 Lampada Alogena



05239-01  
 f./p. Fig. 0-1



05239-02  
 f./p. Fig. 2-4

Laryngoskope  
 Laryngoscopes  
 Laringoscopios  
 Laringoscopi

**MILLER**



05230-00  
 55 mm, 2.1/2"  
 Nutzlänge  
 working length  
 largo útil  
 lunghezza utile

für Säuglinge  
 for babies  
 para neonatales  
 per neonati



05230-01  
 80 mm, 3 1/8"  
 Nutzlänge  
 working length  
 largo útil  
 lunghezza utile

für Kinder  
 for children  
 para niños  
 per bambini



05230-02  
 130 mm, 5"  
 Nutzlänge  
 working length  
 largo útil  
 lunghezza utile

für Jugendliche  
 for adolescents  
 para adolescentes  
 per adolescenti

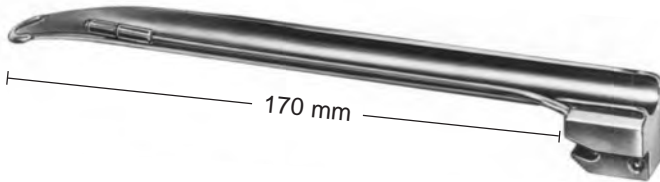

05230-03  
 170 mm, 6 3/4"  
 Nutzlänge  
 working length  
 largo útil  
 lunghezza utile

für Frauen  
 for women  
 para mujeres  
 per donne



05230-04  
 180 mm, 7"  
 Nutzlänge  
 working length  
 largo útil  
 lunghezza utile

für Männer  
 for men  
 para hombres  
 per uomini



05239-01  
 f./p. Fig. 0-1



05239-02  
 f./p. Fig. 2-4



**McIntosh**

05203-00

Set bestehend aus:

- 1 Etui
- 1 Batteriegriff 05234-28
- 3 Spatel (Fg. 2-4)

Set consisting of:

- 1 Case
- 1 Handle
- 3 Blades (Fg. 2-4)

Juego compuesto de:

- 1 Estuche
- 1 Mango
- 3 Hoja (Fg. 2-4)

Set composto da:

- 1 Astuccio
- 1 Manico
- 3 Spatole (Fg. 2-4)

05204-00

Set bestehend aus:

- 1 Etui
- 1 Batteriegriff 05234-28
- 4 Spatel (Fg. 1-4)

Set consisting of:

- 1 Case
- 1 Handle
- 4 Blades (Fg. 1-4)

Juego compuesto de:

- 1 Estuche
- 1 Mango
- 4 Hoja (Fg. 1-4)

Set composto da:

- 1 Astuccio
- 1 Manico
- 4 Spatole (Fg. 1-4)



**Foregger**

05223-00

Set bestehend aus:

- 1 Etui
- 1 Batteriegriff 05234-28
- 3 Spatel (Fg. 2-4)

Set consisting of:

- 1 Case
- 1 Handle
- 3 Blades (Fg. 2-4)

Juego compuesto de:

- 1 Estuche
- 1 Mango
- 3 Hoja (Fg. 2-4)

Set composto da:

- 1 Astuccio
- 1 Manico
- 3 Spatole (Fg. 2-4)

05224-00

Set bestehend aus:

- 1 Etui
- 1 Batteriegriff 05234-28
- 4 Spatel (Fg. 1-4)

Set consisting of:

- 1 Case
- 1 Handle
- 4 Blades (Fg. 1-4)

Juego compuesto de:

- 1 Estuche
- 1 Mango
- 4 Hoja (Fg. 1-4)

Set composto da:

- 1 Astuccio
- 1 Manico
- 4 Spatole (Fg. 1-4)

Batteriegriffe, Warmlicht  
Battery handles, warm light  
Mango de pila, luz caliente  
Manico a batteria, luce calda



05233-18 18 mm ø, 3/4"



05234-28 28 mm ø, 1"  
05234-37 37 mm ø, 1 1/2"



05238-01 30 mm ø, 1 1/4"

Batteriegriffe, Kaltlicht  
Battery handles, cold light  
Mango de pila, luz fria  
Manico a batteria per luce fredda



05238-02  
18 mm  $\varnothing$   
3/4"



05238-03  
30 mm  $\varnothing$   
1 1/4"

Batteriegriffe, Warmlicht  
Battery handles, warm light  
Mango de pila, luz caliente  
Manico a batteria, luce calda



05240-30 30 mm  $\varnothing$ , 1 1/4"  
Griff mit Trafo-Anschluß  
Handle with Transformer-connection  
Mango con conexión al transformador  
Manico con connessione al trasformatore



05241-11 Trafo 110 V  
05241-22 Trafo 220 V

Trafo 110 Volt mit amerikanischem Netzanschluß  
Transformer 110 Volt with american mains connection  
Transformador 110 V con conexión americana  
Trasformatore 110 V ricarica batteria

Trafo 220 Volt mit 1,40 m (55") langem Kabel  
Transformer 220 Volt with cable 1,40 m (55") long  
Transformador, 220 V con cable de 1,40 m (55")  
Trasformatore 220 V ricarica batteria

Laryngoskope  
Laryngoscopes  
Laringoscopios  
Laringoscopi

Operation Laryngoskop:  
rostfreier Edelstahl  
Rohr: innen matt/außen glänzend  
Griff: ganz matt

Operation Laryngoscope:  
stainless steel  
tube: inner surface matt/outer  
surface polished  
handle: matt



Laringoscopio para operaciones:  
Acero inoxidable  
Pala: Superficie interior: Mate  
Superficie exterior: Brillante  
Mango entero: Mate

Laringoscopio a luce  
fredda per microchirurgia  
endolaringeo  
tubo: interiore opaco – esterno lucido  
manico: opaco

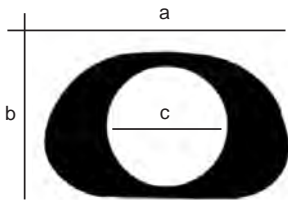

Nr.	L (mm)	a (mm)	b (mm)	c (mm)
05301-01	135	21,8	14,0	13,0
05301-02	152	22,5	14,8	13,0
05301-03	182	23,0	15,0	14,0
05301-04	172	29,5	18,0	17,0
05301-05	172	31,5	21,5	19,0

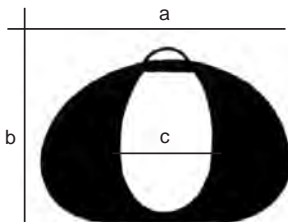

Nr.	L (mm)	a (mm)	b (mm)	c (mm)
05301-06	182	29,0	20,0	16,0 x 26,0
05301-07	222	29,0	20,0	16,0 x 26,0



Laryngoskope  
Laryngoscopes  
Laringoscopios  
Laringoscopi

05300-01/02 Bruststütze für Erwachsene/Kinder bestehend aus:  
 05300-03 Stützstange für Erwachsene 34 cm / 05300-06 Ring / 05300-05 Gelenk  
 05300-04 Stützstange für Kinder 24 cm / 05300-06 Ring / 05300-05 Gelenk  
 05300-01/02 Chest Support for adults/children complete consisting of:  
 05300-03 Support rod for adults 34 cm / 05300-06 Ring / 05300-05 Joint  
 05300-04 Support rod for children 24 cm / 05300-06 Ring / 05300-05 Joint  
 05300-01/02 Soporte pectoral para adultos/niños compuesto de:  
 05300-03 para adultos 34 cm / 05300-06 / 05300-05  
 05300-04 para niños 24 cm / 05300-06 / 05300-05  
 05300-01/02 Braccio portalarinoscopio sternale per adulti/bambini composto da:  
 05300-03 per adulti 34 cm / 05300-06 anello / 05300-05 giunto  
 05300-04 per bambini 24 cm / 05300-06 anello / 05300-05 giunto

Operationslaryngoskop, Kleinsasser  
 Operation laryngoscope, Kleinsasser  
 Laringoscopios operativo, Kleinsasser  
 Laringoscopia operativa, Kleinsasser

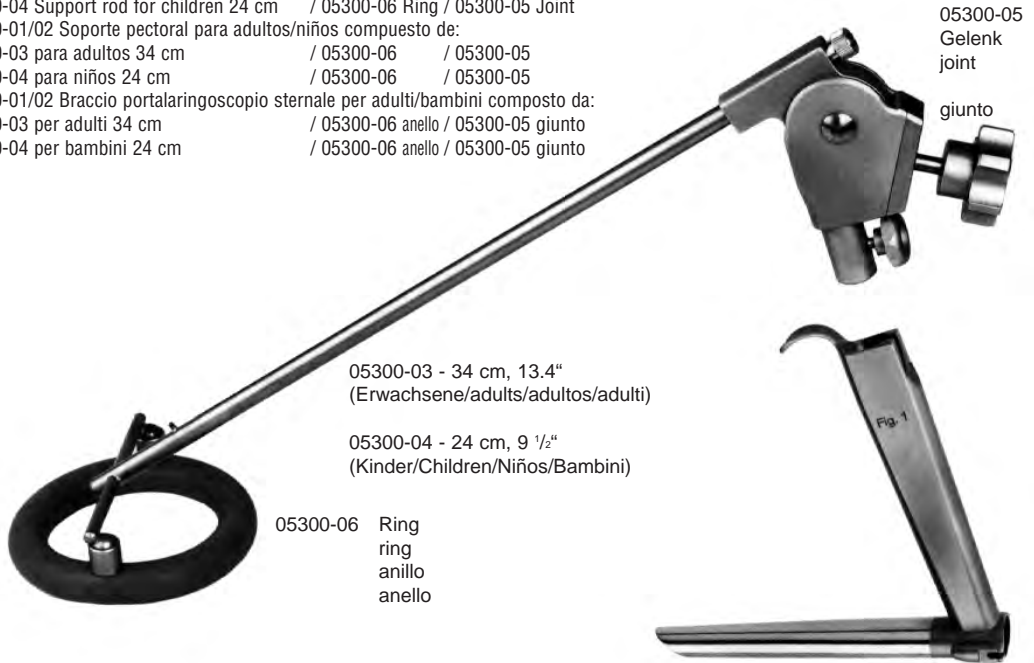

Fiberglas-Lichtträger – Fiberglas-light-guide –  
 Portadore de luz fria – portatore di luce fredda  
 a fibre di vetro

05302-01 for Laryngoskope  
 05301-01 - 05301-02

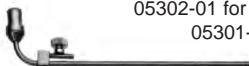

05303-01  
 Injektionskanüle für Laryngoskope: 05301-01 - 05301-07  
 Injection drain tube for Laryngoscopes: 05301-01 - 05301-07  
 Canúla de inyeccion para laringoscopios: 05301-01 - 05301-07  
 Cannula da iniezione per laringoscopi: 05301-01 - 05301-07



05302-02 for Laryngoskope  
 05301-03 - 05301-06

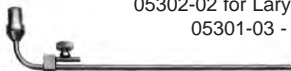

05304-01  
 Rauchabsaugrohr für Laryngoskop: 05301-03 - 05301-07  
 Suction tube for Laryngoscopes: 05301-03 - 05301-07  
 Canúla de succion para laringoscopios: 05301-03 - 05301-07  
 Tubo di aspirazione per laringoscopi: 05301-03 - 05301-07

05302-03 for Laryngoskope  
 05301-07



Laryngoskope  
Laryngoscopes  
Laringoscopios  
Laringoscopi

HOLINGER Laryngoskop  
HOLINGER Laryngoscope  
HOLINGER Laringoscopio  
HOLINGER Laringoscopi

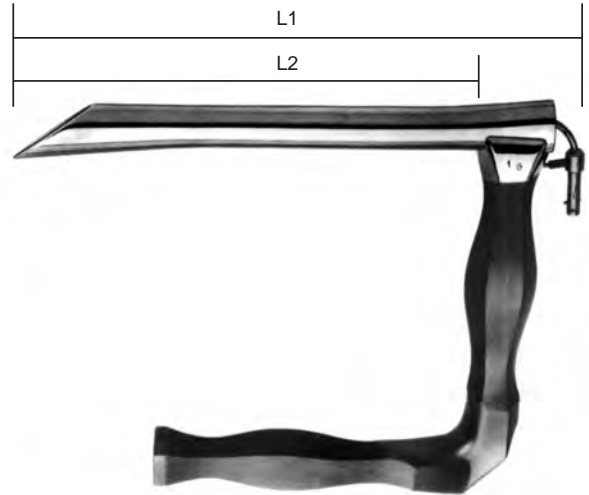

Nr.	L1	L2	Lichtträger light guide Portador de luz portatore di luce
05310-01	180 mm	157 mm	05311-01
05310-02	170 mm	146 mm	05311-02
05310-03	120 mm	98 mm	05311-03
05310-04	90 mm	77 mm	05311-04

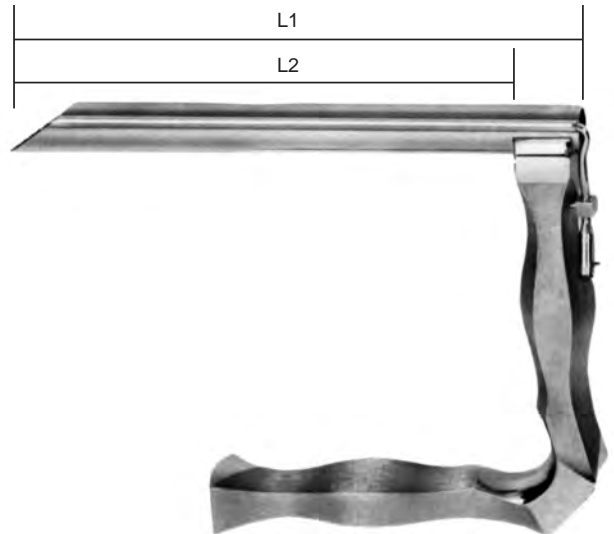

JACKSON Laryngoskop  
JACKSON Laryngoscope  
JACKSON Laringoscopio  
JACKSON Laringoscopi

Nr.	L1	L2	Außen-Dm Outer-dm dm-exterior dm-esterno	Innen-Dm Inner-dm dm-interior dm-interno	Lichtträger light guide Portador de luz portatore di luce
05320-01	160 mm	135 mm	17,5 mm	14,5 mm	05321-01
05320-02	160 mm	135 mm	14,5 mm	12,0 mm	05321-02
05320-03	120 mm	105 mm	14,0 mm	11,5 mm	05321-03
05320-04	90 mm	75 mm	13,0 mm	10,0 mm	05321-04

Skalpelli-Griffe  
Scalpel Handles  
Mangos de bisturíes  
Manici per lama bisturi

passend zu den Klängen  
for blades  
para las hojas  
per lama bisturi

- (A) No. 10, 11, 12, 13, 14, 15, 16, 17, 18, 19
- (B) No. 20, 21, 22, 23, 24, 25



07103-00  
Fig. 3

(A)



07103-01  
Fig. 3 grad.

(A)



07103-02  
Fig. 3 L

(A)

Skalpelli-Griffe  
Scalpel Handles  
Mangos de bisturíes  
Manici per lama bisturi

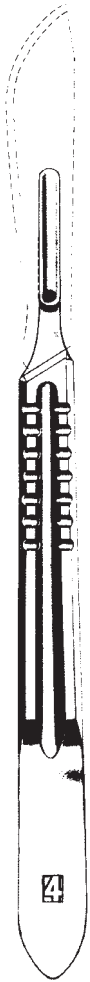

07104-00

Fig. 4

(B)



07104-02

Fig. 4 L

(B)

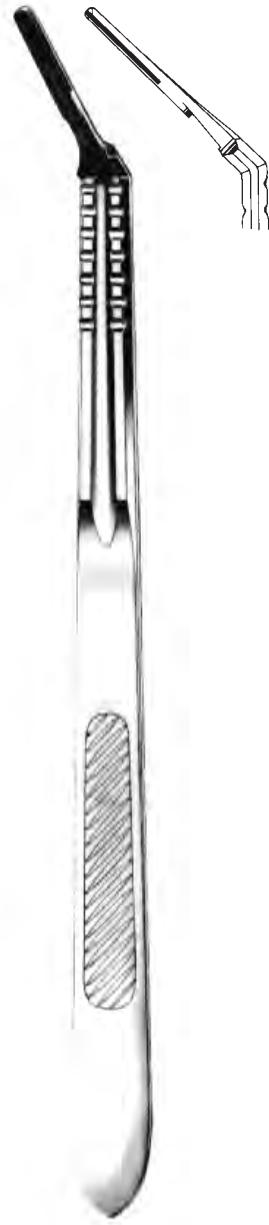

07105-02

Fig. 4 L

(B)

Skalpell-Griffe  
Scalpel Handles  
Mangos de bisturíes  
Manici per lama bisturi



07106-01  
14,5 cm 5 3/4"

(A)



07106-02  
14 cm 5 1/2"

(A)

Skalpelli-Griffe  
Scalpel Handles  
Mangos de bisturíes  
Manici per lama bisturi



07107-00  
Fig. 7

(A)



07107-01  
Fig. 7K

(A)



07107-03

(A)



07107-04

(A)

Skalpelli-Griffe  
Scalpel Handles  
Mangos de bisturíes  
Manici per lama bisturí



07108-00  
Fig. 8  
ⓑ



07109-03  
Fig. 3 L  
Ⓐ

Skalpell-Griffe  
Scalpel Handles  
Mangos de bisturíes  
Manici per lama bisturi



07161-00 07162-00 07165-00 07167-00

Packung mit 10 Stück  
box of 10  
en cajas de 10 pzas  
confezione di 10

07109-10 10,0 cm, 4"  
07109-13 13,0 cm, 5"  
07109-15 15,5 cm, 6"



Einmal-Skalpelle, Steril  
Disposable Scalpels, Sterile  
Bisturios uso único, estériles  
Bisturi monouso, sterili



07210-00

Packung mit 10 Stück  
in packages of 10 each  
en cajas de 10 c/u  
confezione di 10 pezzi



07211-00



07212-00



07213-00



07215-00



07218-00



07219-00



07220-00



07222-00



07224-00



07225-00

Amputationsmesser  
 Amputation Knives  
 Cuchillos para amputaciòn  
 Coltelli per amputazione

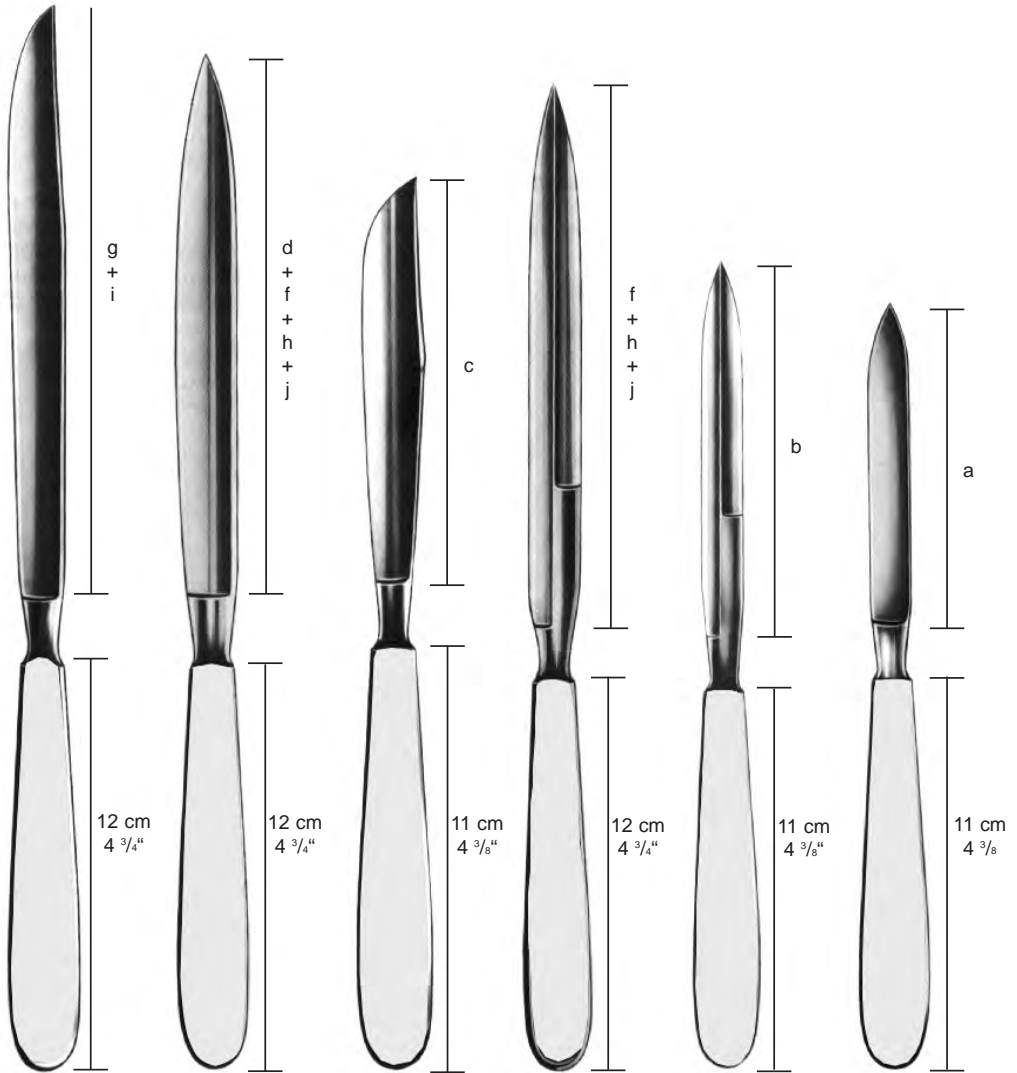

Liston  
 07200-17  
 07200-20

Reda  
 07201-13  
 07201-16  
 07201-19  
 07201-22

Langenbeck  
 07202-12

Catlin  
 doppelschneidig  
 double  
 aftingedeges  
 filo doble  
 doppio taglio  
 07203-16  
 07203-19  
 07203-22

07204-11

Zwischenknochen-  
 messer doppel-  
 schneidig  
 Inerosseous knife  
 double aftingedeges  
 Cuchillo interóseo  
 filo doble  
 Coltello interosseo  
 doppio taglio

07205-09

Phalangen-  
 messer  
 Phalangeal knife  
 Cuchillos para  
 falanges  
 Coltello per falangi

Schnittlänge  
 Length of blades  
 Largo de hojas  
 Lunghezze delle lame

a - 9,5 cm	c - 12,0 cm	e - 15,0 cm	g - 17,0 cm	i - 20,0 cm
b - 11,0 cm	d - 13,0 cm	f - 16,0 cm	h - 19,0 cm	j - 22,0 cm
a - 3 3/4"	c - 4 3/4"	e - 6"	g - 6 3/4"	i - 8"
b - 4 3/8"	d - 5"	f - 6 1/4"	h - 7 1/2"	j - 8 3/4"

Klingenbrecher, Rasierklingen  
Blade Breakers, Razor Blades  
Rompe-hojas, hojas de afeitar  
Lama di rasoio, Rompilamette



TROUTMAN-CHRIS  
07290-09 9 cm, 3 1/2"



REDA  
07291-11 11 cm, 4 3/8"



CASTROVIEJO  
07294-13 13 cm, 5 1/8"

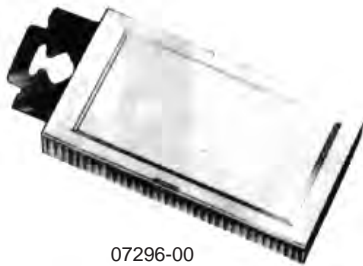

07296-00

Packung = 10 Stück  
package = 10 each  
caja = 10 c/u  
confezione = 10 pezzi

Skalpelle mit Metallheft  
 Scalpels with Metal Handle  
 Bisturíes, mango metálico  
 Bisturi, manico di metallo



Fig. 1  
 07402-01  
 15 cm, 6"  
 30 mm, 1.2"



Fig. 2  
 07402-02  
 15 cm, 6"  
 36 mm, 1.4"



Fig. 3  
 07402-03  
 15,5 cm, 6"  
 40 mm, 1 1/2"



Fig. 4  
 07402-04  
 16 cm, 6 1/4"  
 45 mm, 1 3/4"



Fig. 5  
 07402-05  
 16 cm, 6 1/4"  
 50 mm, 2"



Fig. 6  
 07402-06  
 15 cm, 6"  
 27 mm, 1"



Fig. 7  
 07402-07  
 15 cm, 6"  
 35 mm, 1.4"



Fig. 8  
 07402-08  
 16 cm, 6 1/4"  
 40 mm, 1 1/2"



Fig. 9  
 07402-09  
 16 cm, 6 1/4"  
 47 mm, 1.9"



Fig. 10  
 07402-10  
 17 cm, 6 3/4"  
 50 mm, 2"

Resektions- und Knorpelmesser  
Resection and Cartilage Knives  
Cuchillos para resección/cartilagos  
Coltelli per resezione e cartilagini



6,5 cm  
2.6"

Beinhautmesser  
mit Schaber  
Periosteum Knife  
with raspatory  
Cuchillo para  
periostio, con  
periostótamo  
Coltello per  
periostio con  
raschino

19 cm, 7 1/2"

07403-01

Metallheft  
metal handle  
mango metálico  
manico di metallo



6,5 cm  
2.6"

Holzheft  
wooden handle  
mango de madera  
manico in legno

19 cm, 7 1/2"

07403-02



5,5 cm  
2.2"



07412-05

18 cm, 7"

07410-05  
Langenbeck

Sezier-, Hirn- und Organmesser  
 Autopsy- Brain- and Post mortem knives  
 Cuchillos para autopsia- cerebro- órganos  
 Coltelli per cartilagini- cervello e organi

Schnittlänge  
 Length of blades  
 Largo de hojas  
 Lunghezze delle lame

- a - 8,5 cm, 3 3/4"
- b - 9,5 cm, 3 3/4"
- c - 11,0 cm, 4 3/8"
- d - 14,0 cm, 5 1/2"
- e - 16,0 cm, 6 1/4"
- f - 17,0 cm, 6 3/4"
- g - 19,5 cm, 7 3/4"
- h - 20,0 cm, 8"
- i - 24,0 cm, 9 1/2"

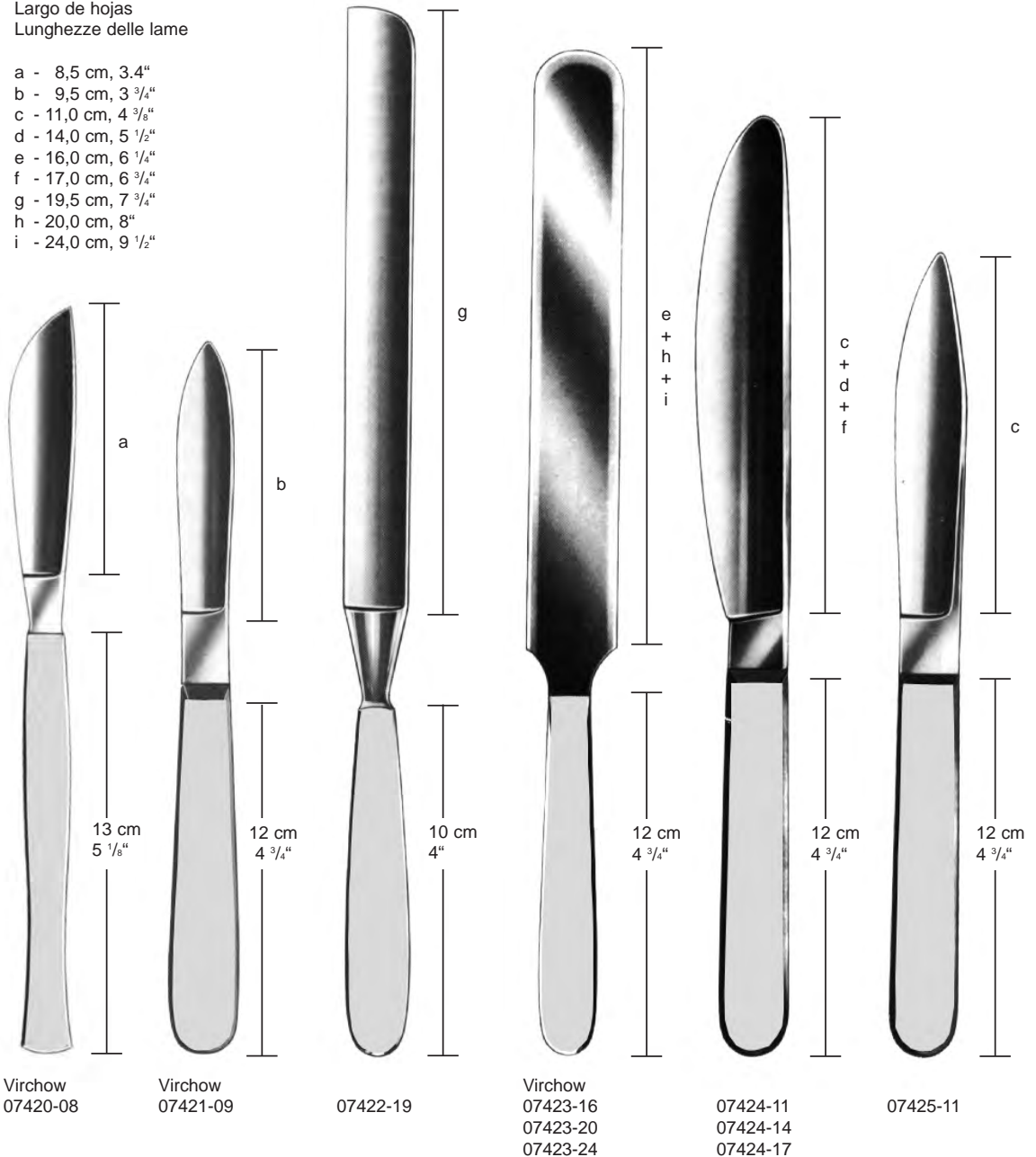

Dermatome, Rasiermesser  
 Dermatome, Razor  
 Dermátomo, Navajas  
 Dermatomo, Rasoio



SCHINK  
 07490-00  
 30 cm, 11 3/4"  
 0,1 - 2 mm  
 compl.  
 mit/with/con

07490-01 (1) Stk./ pcs/ pzas  
 07490-02 (2) Stk./ pcs/ pzas



07490-01  
 Ersatzklinge  
 Spare blade  
 Hoja de repuesto  
 Lama di ricambio per dermatomo

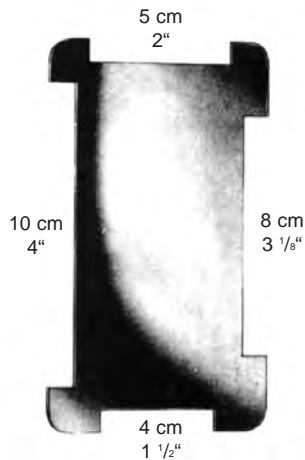

07490-02  
 Spannplatte  
 Skin straightening plate  
 Placa para extender la piel  
 Placca per stendipelle



07496-00  
 Rasiermesser 8 cm, 3 1/8"  
 Razors 8 cm, 3 1/8"  
 Navajas 8 cm, 3 1/8"  
 Rasoio 8 cm, 3 1/8"

Dermatome  
 Dermatome  
 Dermátomo  
 Dermatomo

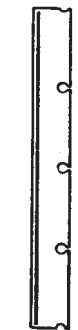
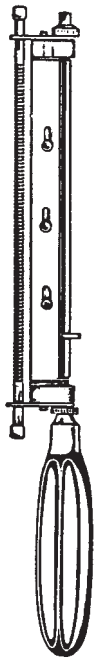

07496-31

Ersatzklingen  
 Spare blades pack  
 Hoja de repuesto  
 Lame di ricambio

HUMBY  
 07495-31 31 cm, 12 1/4"  
 0,1 - 1,2 mm



SILVER  
 07498-00  
 190 mm, 7 1/2"  
 Dermatome, ohne Klinge  
 Skin graft knife, without blade  
 Dermátomo sin hoja  
 Senza lama utilizzo con lamette  
 da barba normale



Klingen  
 blades  
 bisturi  
 07499-01

WATSON  
 07499-00  
 300 mm, 11 3/4"  
 Dermatome, ohne Klinge  
 Skin graft knife, without blade  
 Dermátomo sin hoja  
 Senza lama utilizzo con lamette  
 da barba normale



Chirurgische Scheren  
 Operating Scissors  
 Tijeras para cirugía  
 Forbici per chirurgia



STANDARD

- 09102-11 11,5 cm, 4 1/2"
- 09102-13 13,0 cm, 5"
- 09102-14 14,5 cm, 5 3/4"
- 09104-14 TC**
- 09102-15 15,5 cm, 6"
- 09102-16 16,5 cm, 6 1/2"
- 09102-18 18,5 cm, 7 1/4"
- 09102-20 20,0 cm, 8"



STANDARD

- 09110-11 11,5 cm, 4 1/2"
- 09110-13 13,0 cm, 5"
- 09110-14 14,5 cm, 5 3/4"
- 09114-14 TC**
- 09110-15 15,5 cm, 6"
- 09110-16 16,5 cm, 6 1/2"
- 09110-18 18,5 cm, 7 1/4"
- 09110-20 20,0 cm, 8"



STANDARD

- 09120-11 11,5 cm, 4 1/2"
- 09120-13 13,0 cm, 5"
- 09120-14 14,5 cm, 5 3/4"
- 09124-14 TC**
- 09120-15 15,5 cm, 6"
- 09120-16 16,5 cm, 6 1/2"
- 09120-18 18,5 cm, 7 1/4"
- 09120-20 20,0 cm, 8"



STANDARD

- 09103-11 11,5 cm, 4 1/2"
- 09103-13 13,0 cm, 5"
- 09103-14 14,5 cm, 5 3/4"
- 09105-14 TC**
- 09103-15 15,5 cm, 6"
- 09103-16 16,5 cm, 6 1/2"
- 09103-18 18,5 cm, 7 1/4"
- 09103-20 20,0 cm, 8"



STANDARD

- 09111-11 11,5 cm, 4 1/2"
- 09111-13 13,0 cm, 5"
- 09111-14 14,5 cm, 5 3/4"
- 09115-14 TC**
- 09111-15 15,5 cm, 6"
- 09111-16 16,5 cm, 6 1/2"
- 09111-18 18,5 cm, 7 1/4"
- 09111-20 20,0 cm, 8"



STANDARD

- 09121-11 11,5 cm, 4 1/2"
- 09121-13 13,0 cm, 5"
- 09121-14 14,5 cm, 5 3/4"
- 09125-14 TC**
- 09121-15 15,5 cm, 6"
- 09121-16 16,5 cm, 6 1/2"
- 09121-18 18,5 cm, 7 1/4"
- 09121-20 20,0 cm, 8"

Präparierscheren  
Dissecting Scissors  
Tijeras de disección  
Forbici per dissezione

Inzisionsschere – Incision Scissors – Tijera de incision – Forbici per incisione

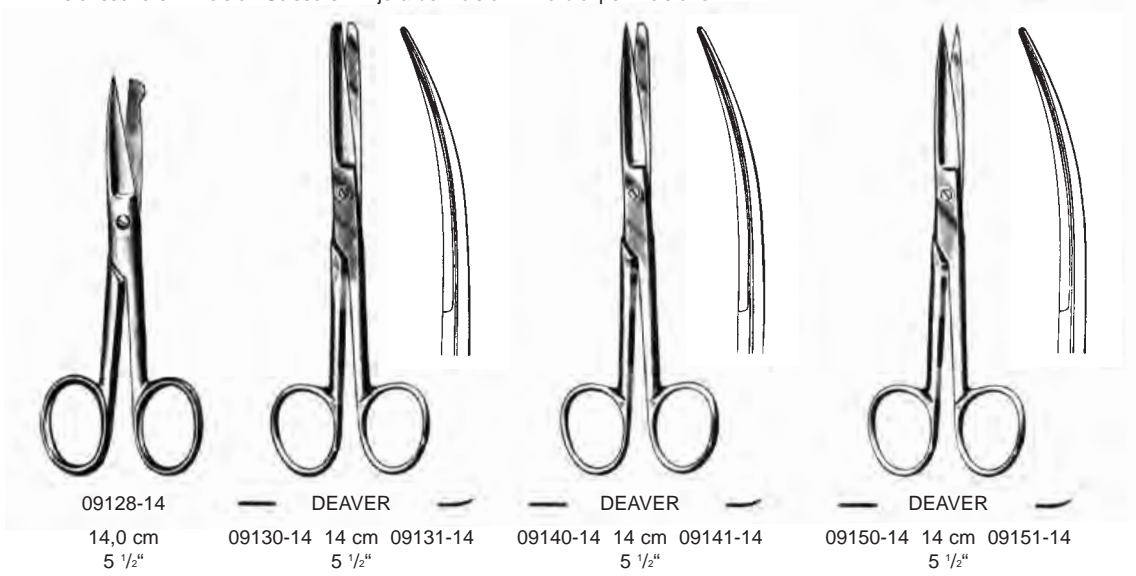

09128-14  
14,0 cm  
5 1/2"

— DEAVER —  
09130-14 14 cm 09131-14  
5 1/2"

— DEAVER —  
09140-14 14 cm 09141-14  
5 1/2"

— DEAVER —  
09150-14 14 cm 09151-14  
5 1/2"



— MAYO —  
09160-14 14,5 cm 09161-14  
09164-14 TC 14,5 cm 09165-14 TC  
5 3/4"  
09160-17 17,0 cm 09161-17  
09164-17 TC 17,0 cm 09165-17 TC  
6 3/4"  
09160-23 23,0 cm 09161-23  
09164-23 TC 23,0 cm 09165-23 TC  
9"

— MAYO-STILLE —  
09170-15 15,0 cm 09171-15  
09174-15 TC 15,0 cm 09175-15 TC  
6"  
09170-17 17,0 cm 09171-17  
09174-17 TC 17,0 cm 09175-17 TC  
6 3/4"  
09170-21 21,0 cm 09171-21  
09174-21 TC 21,0 cm 09175-21 TC  
8 1/4"

— MAYO-NOBLE —  
09180-17 17,0 cm 09181-17  
6 3/4"

Präparierscheren  
Dissecting Scissors  
Tijeras de disección  
Forbici per dissezione



LEXER  
09190-16  
09194-16 TC  
16 cm, 6 1/4"

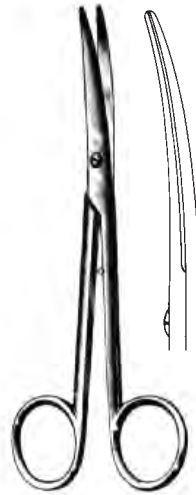

LEXER  
09191-16  
09195-16 TC  
16 cm, 6 1/4"



LEXER BABY  
09202-10 09203-10  
09206-10 TC 09207-10 TC  
10 cm, 4"

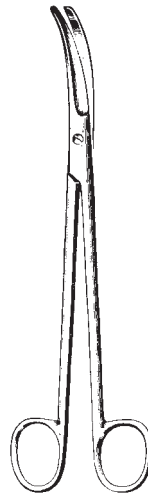

JORGENSEN  
09204-22  
22 cm, 8 3/4"

Präparierscheren  
 Dissecting Scissors  
 Tijeras de disección  
 Forbici per dissezione



- METZENBAUM**
- 09280-12 **09284-12 TC**  
12 cm 4 3/4"
  - 09280-15 **09284-15 TC**  
15 cm 6"
  - 09280-18 **09284-18 TC**  
18 cm 7"
  - 09280-20 **09284-20 TC**  
20 cm 8"
  - 09280-23 **09284-23 TC**  
23 cm 9"
  - 09280-25 **09284-25 TC**  
25 cm 10"
  - 09280-28 **09284-28 TC**  
28 cm 11"
  - 09280-30 **09284-30 TC**  
30 cm 12"



- METZENBAUM**
- 09281-12 **09285-12 TC**  
12 cm 4 3/4"
  - 09281-15 **09285-15 TC**  
15 cm 6"
  - 09281-18 **09285-18 TC**  
18 cm 7"
  - 09281-20 **09285-20 TC**  
20 cm 8"
  - 09281-23 **09285-23 TC**  
23 cm 9"
  - 09281-25 **09285-25 TC**  
25 cm 10"
  - 09281-28 **09285-28 TC**  
28 cm 11"
  - 09281-30 **09285-30 TC**  
30 cm 12"



- METZENBAUM FINO**
- 09282-15 **09286-15 TC**  
15 cm 6"
  - 09282-18 **09286-18 TC**  
18 cm 7"
  - 09282-20 **09286-20 TC**  
20 cm 8"
  - 09282-23 **09286-23 TC**  
23 cm 9"
  - 09282-25 **09286-25 TC**  
25 cm 10"
  - 09282-28 **09286-28 TC**  
28 cm 11"



- METZENBAUM FINO**
- 09283-15 **09287-15 TC**  
15 cm 6"
  - 09283-18 **09287-18 TC**  
18 cm 7"
  - 09283-20 **09287-20 TC**  
20 cm 8"
  - 09283-23 **09287-23 TC**  
23 cm 9"
  - 09283-25 **09287-25 TC**  
25 cm 10"
  - 09283-28 **09287-28 TC**  
28 cm 11"

Präparierschere / Kapselschere  
Dissecting Scissors / Capsula Scissor  
Tijeras de disección / Tijera p. cápsula  
Forbici per dissezione / Forbici per capsula

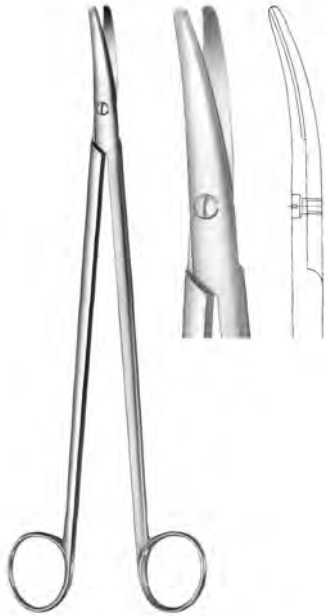

WELLER  
09289-28  
28 cm, 11"



RESANO  
09290-25  
25 cm, 10"

Chirurgische Scheren, fein  
 Operating Scissors, fine  
 Tijeras para cirugía, finas  
 Forbici per chirurgia, fine



METZENBAUM "S"

09291-18 18 cm, 7" 09295-18 TC  
 09291-20 20 cm, 8" 09295-20 TC  
 09291-23 23 cm, 9" 09295-23 TC

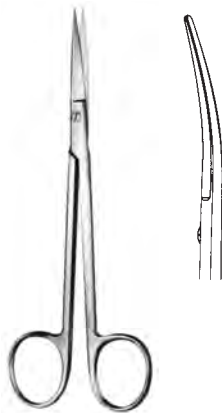

SANVENERO

09302-14 14 cm 09303-14  
 5 1/2"

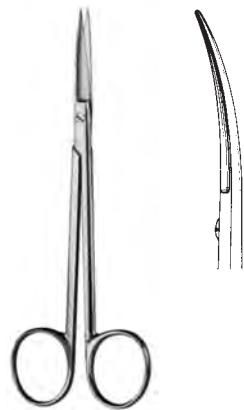

JOSEPH

09304-14 14 cm 09305-14  
 5 1/2"

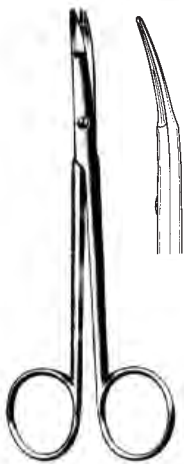

KILNER

09310-12 12 cm 09314-12 TC  
 09310-15 15 cm  
 09312-12 12 cm gerade/straight/recta/retta

9 cm 3 1/2"  
 10 cm 4"  
 11 cm 4 3/8"  
 12 cm 4 3/4"  
 15 cm 6"



REYNOLDS

09320-15 15 cm 09321-15  
 09321-18  
 09325-15 TC

Iris - Standard

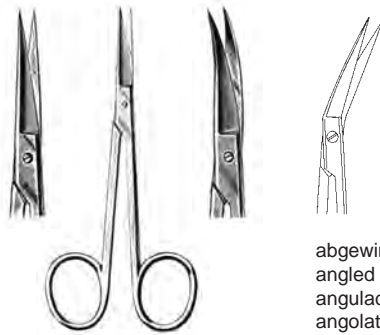

abgewinkelt  
 angled  
 angulada  
 angolata

09340-09 9 cm 09341-09 09346-11 11 cm  
 09340-10 10 cm 09341-10  
 09340-11 11 cm 09341-11  
 09344-11 TC 09345-11 TC

Chirurgische Scheren, fein  
Operating Scissors, fine  
Tijeras para cirugía, finas  
Forbici per chirurgia, fine

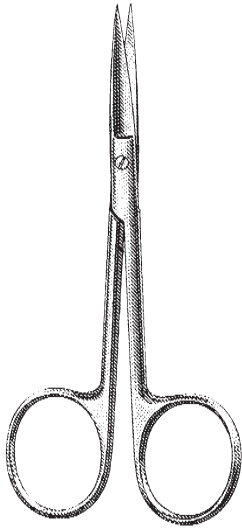

— KNAPP —  
10 cm, 4"  
09348-01 09348-02

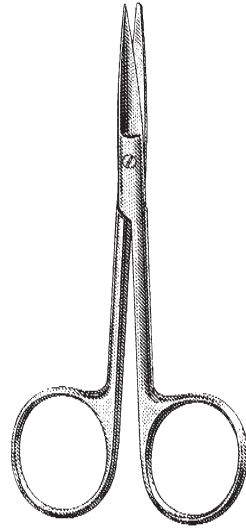

— KNAPP —  
10 cm, 4"  
09348-03 09348-04

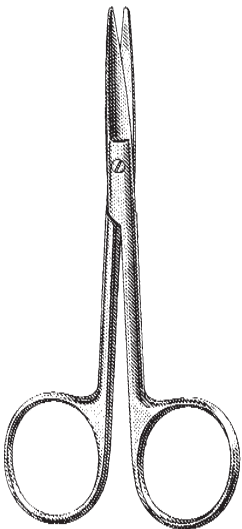

— KNAPP —  
10 cm, 4"  
09348-05 09348-06

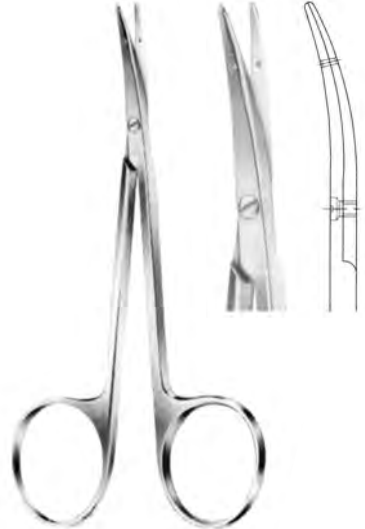

LITTLER  
12 cm, 4 3/4"  
09349-12

Präparierscheren, feines Modell  
Dissecting Scissors, fine pattern  
Tijeras de disección, finas  
Forbici per preparazione, modello fino



GRAEFE  
09350-10  
100 mm  
4"



COTTLE  
09358-11  
115 mm  
4 1/2"



Scheren, Ophthalmologie  
 Scissors, Ophtalmology  
 Tijeras, oftalmología  
 Forbici, per oftalmologia



GRADLE

09350-09 09351-09  
 9,5 cm, 3 3/4"

gerade	gebogen
straight	curved
rectas	curvas
retta	curva



09352-09 09353-09  
 9,5 cm, 3 3/4"

gerade	gebogen
straight	curved
rectas	curvas
retta	curva



09354-10 09355-10  
 10 cm, 4"

gerade	gebogen
straight	curved
rectas	curvas
retta	curva



09356-10 09357-10  
 10 cm, 4"

gerade	gebogen
straight	curved
rectas	curvas
retta	curva

Scheren, Ophthal, Nase  
 Scissors, Ophthal, Nasal  
 Tijeras, oftalmología, nasales  
 Forbici, oftalmologia, nasali

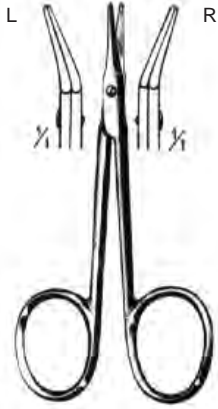

AEBLI  
 09347-09 9 cm 09349-09  
 3 1/2"



STEVENS  
 11 cm  
 4 3/8"

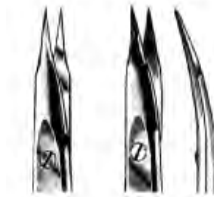

09360-11 09361-11



09362-11 09363-11



ENUCLEATION  
 09381-11  
 13 cm, 5 1/8"



STRABISMUS  
 09370-11 09371-11  
 09374-11 TC 09375-11 TC  
 11 cm, 4 3/8"



HEYMANN  
 09401-18  
 18 cm, 7"



FOMON  
 09403-15  
 15 cm, 6"

Tonsillen-, Gefäßscheren  
 Tonsil, Vascular Scissors  
 Tijeras, amígdalas y vasculares  
 Forbici per tonsilli e vascolari



COTTLE  
 09405-16  
 09406-16 TC  
 16 cm, 6 1/4"



DEAN  
 09425-17 09427-17  
 17 cm, 6 3/4"



BOETTCHER  
 09435-18  
 18 cm, 7"

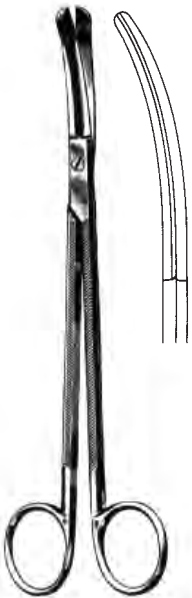

GOOD  
 09437-19  
 19 cm, 7 1/2"



PRINCE  
 09439-17  
 17 cm, 6 3/4"



09468-15  
 15 cm, 6"



09470-11  
 11 cm, 4 3/8"

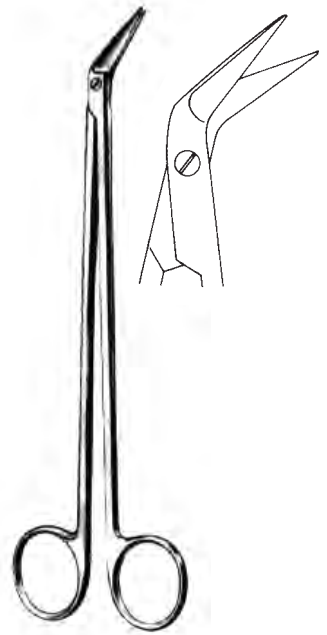

POTTS-DE MARTEL  
 09473-21  
 21 cm, 8 1/4"

Scheren, Thorax und Gefäße  
 Scissors, thorax and vascular  
 Tijeras, torácicas y vasculares  
 Forbici vascolari e toraciche



DIETRICH  
 09475-25 – 09475-00  
 17 cm, 6 3/4"



09475-25  
**09476-25 TC**  
 18 cm, 7"

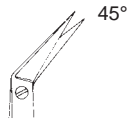

09475-45  
**09476-45 TC**  
 18 cm, 7"

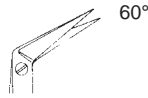

09475-60  
**09476-60 TC**  
 17,5 cm, 6.9"

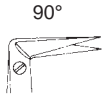

09475-90  
**09476-90 TC**  
 17 cm, 6 3/4"



09475-00  
**09476-00 TC**  
 17 cm, 6 3/4"



DIETRICH  
 09477-01  
 17 cm, 6 3/4"

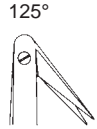

Scheren mit Hartmetalleinsätzen  
 Scissors with Tungsten Carbide  
 Tijeras con carburo de tungsteno  
 Forbici con carburo di tungsteno



De Bakey  
 (Potts-Smith)



**09478-25**  
 19 cm  
 7 1/2"



**09478-45**  
 19 cm  
 7 1/2"



**09478-60**  
 19 cm  
 7 1/2"



**09479-25**  
 23 cm  
 9"

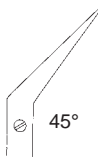

**09479-45**  
 23 cm  
 9"

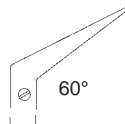

**09479-60**  
 23 cm  
 9"

Gefäßscheren  
 Vascular Scissors  
 Tijeras vasculares  
 Forbici vascolari



POTTS-SMITH  
 19 cm, 7 1/2"

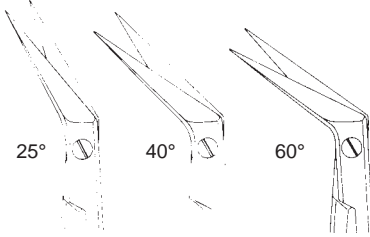

09480-25      09480-40      09480-60  
 09481-25 TC    09481-40 TC    09481-60 TC

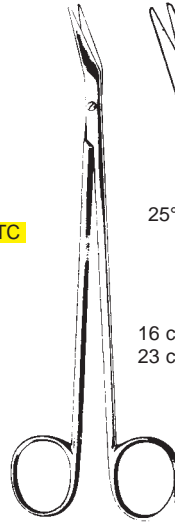

DE BAKEY

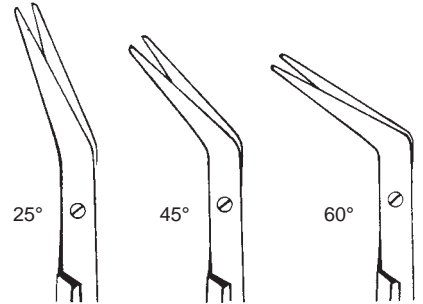

16 cm 09490-16    09491-16    09492-16  
 23 cm 09490-23    09491-23    09492-23

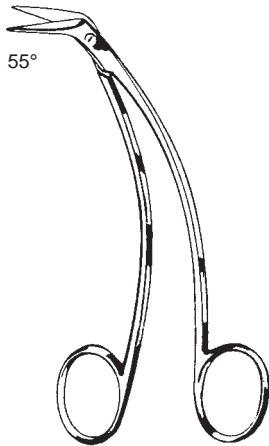

FAVALORO  
 09496-15 15 cm, 6"

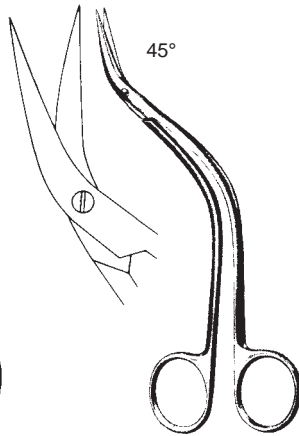

DE BAKEY  
 09497-15 15,5 cm, 6"



KELLY  
 09540-16    09541-16  
 09542-16 TC    09543-16 TC  
 16 cm, 6 1/4"

Gynäkologische Scheren  
 Gynecological Scissors  
 Tijeras ginecológicas  
 Forbici ginecologiche



SIMS

09510-20	20 cm, 8"	09511-20
09510-23	23 cm, 9"	09511-23
09516-23 TC	23 cm, 9"	09517-23 TC



09512-20  
09512-23



09513-20  
09513-23



09514-20  
09514-23



09515-20  
09515-23



SIEBOLD

09523-24 24 cm, 9 1/2"



**Parametrium**



09501-22 22,5 cm, 8.9"  
 09505-22 TC 22,5 cm, 8.9"

09501-23 23 cm, 9"  
 09505-23 TC 23 cm, 9"



WERTHEIM  
 09525-22 22,5 cm, 8.9"



DOYEN  
 09530-17 09531-17  
 17,5 cm, 6.9"



DUBOIS  
 09536-27 09537-27  
 27 cm, 10 1/2"

Chirurgische Scheren  
Operating Scissors  
Tijeras para cirugía  
Forbici per chirurgia



gezahnt  
saw edge  
dentadas  
dentellata

WALDMANN  
09548-18  
18 cm, 7"



U.S.A. Mod.  
09550-10  
10,5 cm, 4"



BUSCH  
09551-16  
16 cm, 6 1/4"



SCHUMACHER  
09553-16  
16 cm, 6 1/4"



BRAUN-STADLER  
09560-14 14,5 cm, 5 3/4"  
09560-22 22,0 cm, 8 3/4"



Neurochirurgie - Neurosurgery - Neurocirugía - Neurochirurgia

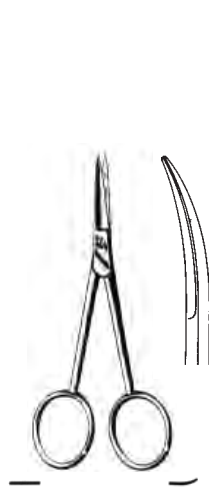

09580-11 09581-11  
11 cm, 4 3/8"

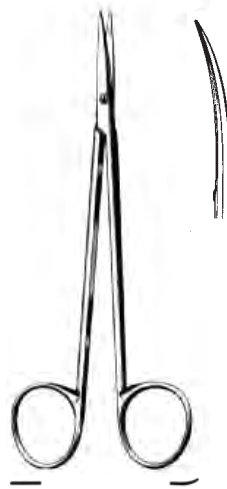

09582-15 09583-15  
15 cm, 6"

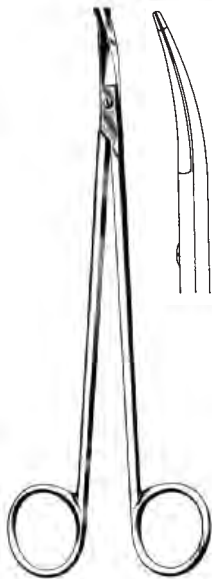

STRULLY  
09601-22  
22 cm, 8 3/4"



TOENNIS-ADSON  
09610-18  
18 cm, 7"

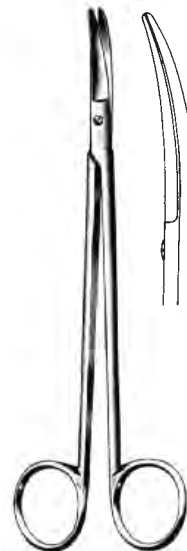

TOENNIS-ADSON  
09611-18  
18 cm, 7"

Chirurgische Scheren  
Operating Scissors  
Tijeras para cirugía  
Forbici per chirurgia



gezahnt  
saw edge  
dentadas  
dentellata

MARTIN CARTILAGE  
09613-20  
20 cm, 8"



McINDOE  
09614-19  
19 cm, 7 1/2"



FOMON  
09617-13  
13 cm, 5 1/8"



SCHMIEDEN-TAYLOR  
09619-17  
17 cm, 6 3/4"

Chirurgische Scheren  
Operating Scissors  
Tijeras para cirugía  
Forbici per chirurgia

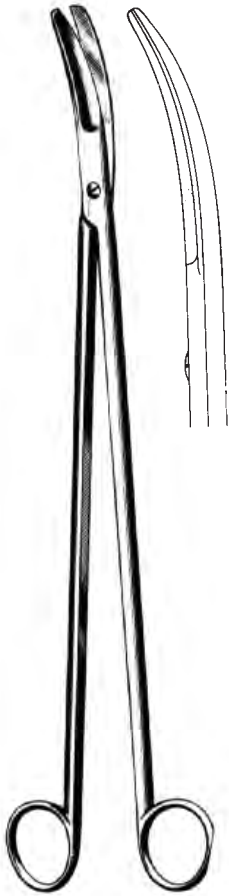

CRAFOORD  
09641-30  
30 cm, 11 3/4"



THOREK  
09643-19 19 cm, 7 1/2"  
09643-25 25 cm, 10"

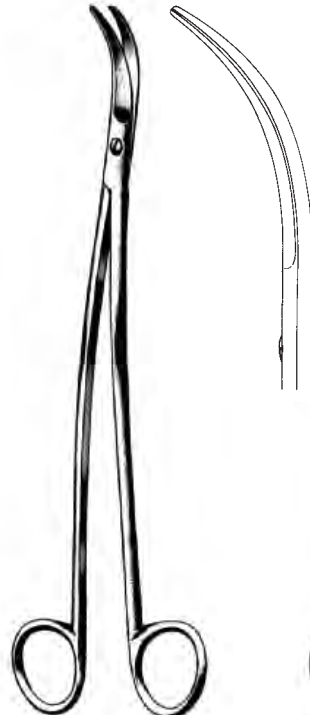

SATINSKY  
09651-24  
24,5 cm, 9 1/2"

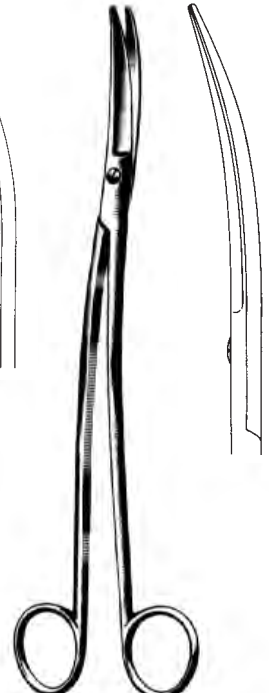

KLINKENBERGH-LOTH  
09661-23  
23 cm, 9"

Chirurgische Scheren  
 Operating Scissors  
 Tijeras para cirugía  
 Forbici per chirurgia

Darmscheren  
 Enterotomy Scissors  
 Enterótomos  
 Forbici per enterotomia



FERGUSSON  
 09770-18  
 18 cm, 7"



09772-21  
 21 cm, 8 1/4"



09774-21  
 21 cm, 8 1/4"



— SYSTRUNK —  
 09775-13 09777-13  
 13 cm, 5 1/8"

Ligaturscheren, Fadenscheren  
 Ligature Scissors  
 Tijeras para ligaduras  
 Forbici per legature



SPENCER  
 09802-09  
 9 cm, 3 1/2"



SPENCER  
 09802-11  
 11 cm, 4 3/8"



NORTHBENT  
 09803-09 9 cm, 3 1/2"  
 09803-13 13 cm, 5 1/8"



LITTAUER  
 09804-14  
 14 cm, 5 1/2"



HEATH  
 09809-15  
 15 cm, 6"

**Zahnfleischscheren**  
**Gum Scissors**  
**Tijeras para encías**  
**Forbici gengivali**

1 Schneide gezahnt  
 1 blade toothed  
 1 hoja dentada  
 1 taglio della lama dentellato

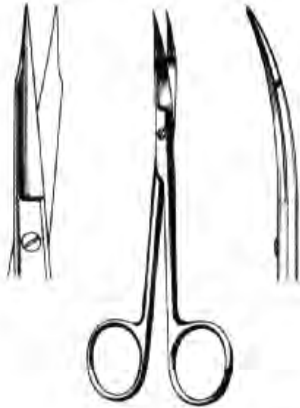

— GOLDMAN-FOX —  
 09820-13 13 cm, 5 1/8" 09821-13

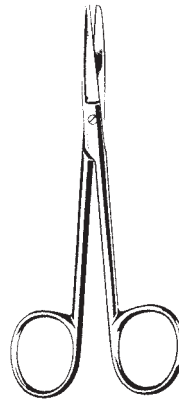

WAGNER  
 12 cm, 4 3/4"

gerade  
 straight  
 rectas  
 rette



Fig. 1  
 09828-12



Fig. 2  
 09826-12



Fig. 3  
 09824-12

gebogen  
 curved  
 curvas  
 curve



Fig. 1  
 09823-12



Fig. 2  
 09829-12



Fig. 3  
 09825-12

**Draht-, Blehschere**  
**Wire and plate shears**  
**Tijeras para alambre y láminas**  
**Forbici per filo di metallo e lamiera**



QUINBY  
 09827-12 12 cm, 4 3/4"



UNIVERSAL  
 09831-12 12 cm, 4 3/4"  
 09835-12 TC 12 cm, 4 3/4"

Beebee Kronenscheren  
Beebee Crown Scissors  
Beebee Tijeras para coronas  
Beebee Forbici per corona



Beebee

09850-10  
gerade 10,5 cm (4") spitz  
straight 10,5 cm (4") pointed  
rectas 10,5 cm (4") agudas  
rette 10,5 cm (4") acute

09852-10  
gerade 10,5 cm (4") stumpf  
straight 10,5 cm (4") blunt  
rectas 10,5 cm (4") romas  
rette 10,5 cm (4") smusse

09851-10  
gebogen 10,5 cm (4") spitz  
curved 10,5 cm (4") pointed  
curvas 10,5 cm (4") agudas  
curve 10,5 cm (4") acute

09853-10  
gebogen 10,5 cm (4") stumpf  
curved 10,5 cm (4") blunt  
curvas 10,5 cm (4") romas  
curve 10,5 cm (4") smusse

Zahnfleischscheren  
 Gum Scissors  
 Tijeras para encias  
 Forbici gengivali



LA Grange  
 09854-11  
 11,5 cm, 4 1/2"



gezahnt  
 saw edge  
 dentadas  
 dentellata

LOCKLIN  
 09859-16  
 16 cm, 6 1/4"



gezahnt  
 saw edge  
 dentadas  
 dentellata

LOCKLIN  
 09860-16  
 16,5 cm , 6 1/2"



LOCKLIN  
 09861-16 TC  
 16,5 cm, 6 1/2"

Verbandscheren  
 Bandage Scissors  
 Tijeras para vendajes  
 Forbici per bendaggi

Gaze  
 Gauze  
 Gaza  
 Garza



SMITH US ARMY  
 09898-20  
 20 cm, 8"



LISTER  
 9 cm, 3 1/2" 09901-09  
 11 cm, 4 3/8" 09901-11  
 14 cm, 5 1/2" 09901-14 09905-14 TC  
 18 cm, 7" 09901-18 09905-18 TC  
 20 cm, 8" 09901-20



LISTER  
 09906-18 18 cm, 7"  
 09906-20 20 cm, 8"



BERGMANN  
 09911-23  
 23 cm, 9"



Verbandscheren  
Bandage Scissors  
Tijeras para vendajes  
Forbici per bendaggi



ESMARCH  
09913-20 20 cm, 8"  
09913-22 22 cm, 8 3/4"



SEUTIN  
09915-23  
23 cm, 9"

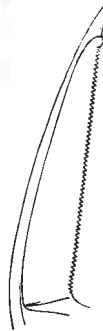

gezahnt  
toothed  
dentadas  
dentellata

REDA EXCENTER  
09921-16 16 cm, 6 1/4"  
09921-19 19 cm, 7 1/2"

Verbandscheren  
 Bandage Scissors  
 Tijeras para vendajes  
 Forbici per bendaggi



KNOWLES  
 09930-14  
 14 cm, 5 1/2"



KNOWLES  
 09931-14  
 14 cm, 5 1/2"



LORENZ  
 09933-23  
 23 cm, 9"



BRUNS  
 09935-23 23 cm, 9" **09939-23 TC**  
 09937-23 23 cm, 9"



09941-20  
 20 cm, 8"

in verschiedenen Farben lieferbar  
 in different colours available  
 en diferentes colores disponibles  
 in differenti colori disponibile



UNIVERSAL  
 09950-15 15 cm, 6"  
 09950-18 18 cm, 7"

Supercut Scheren  
Supercut Scissors  
Tijeras Supercut  
Forbici Supercut



gezahnt  
saw edge  
dentadas  
dentellate

09960-14 09961-14  
14,5 cm, 5 3/4"  
gerade gebogen  
straight curved  
rectas curvas  
rette curve



gezahnt  
saw edge  
dentadas  
dentellate

MAYO  
09962-14 14,5 cm 09963-14  
09962-17 17,0 cm 09963-17  
09962-23 23,0 cm 09963-23  
gerade gebogen  
straight curved  
rectas curvas  
rette curve



gezahnt  
saw edge  
dentadas  
dentellate

MAYO-STILLE  
09964-15 15,0 cm 09965-15  
09964-17 17,0 cm 09965-17  
gerade gebogen  
straight curved  
rectas curvas  
rette curve



gezahnt  
saw edge  
dentadas  
dentellate

BABY METZENBAUM  
09966-11 09967-11  
11,5 cm, 4 1/2"  
gerade gebogen  
straight curved  
rectas curvas  
rette curve



gezahnt  
saw edge  
dentadas  
dentellate

METZENBAUM  
09970-14 14,5 cm 09971-14  
09970-18 18,0 cm 09971-18  
09970-20 20,0 cm 09971-20  
09970-23 23,0 cm 09971-23  
gerade gebogen  
straight curved  
rectas curvas  
rette curve

Supercut Scheren  
 Supercut Scissors  
 Tijeras Supercut  
 Forbici Supercut



gezahnt  
 saw edge  
 dentadas  
 dentellate

IRIS  
 09980-11 09981-11  
 11,5 cm, 4 1/2"  
 gerade gebogen  
 straight curved  
 rectas curvas  
 rette curve



gezahnt  
 saw edge  
 dentadas  
 dentellate

WAGNER  
 09982-12 09983-12  
 12 cm, 4 3/4"  
 gerade gebogen  
 straight curved  
 rectas curvas  
 rette curve



STEVENS  
 09984-11 09985-11  
 11,5 cm, 4 1/2"  
 gerade gebogen  
 straight curved  
 rectas curvas  
 rette curve



gezahnt  
 saw edge  
 dentadas  
 dentellate

LaGrange  
 09986-11 11,5 cm, 4 1/2"



gezahnt  
 saw edge  
 dentadas  
 dentellate

LISTER  
 09990-14 14,5 cm, 5 3/4"  
 09990-18 18,0 cm, 7"



REYNOLDS  
 09993-15 15 cm, 6"  
 09993-18 18 cm, 7"



KILNER/RAGNELL  
 09995-12 12 cm, 4 3/4"

Face Lift Scheren  
 Face Lift Scissors  
 Tijeras Face Lift  
 Forbici Face Lift



GORNEY FACE LIFT  
 19 cm, 7 1/2"



10010-19  
**10012-19 TC**  
 10014-19 Supercut



10011-19  
**10013-19 TC**  
 10015-19 Supercut



REES FACE LIFT

- 10016-17 — 17,0 cm, 6 3/4"
- 10017-17 — 17,0 cm, 6 3/4"
- 10018-20 — 20,5 cm, 8"
- 10019-20 — 20,5 cm, 8"

TC

- 10020-17** — 17,0 cm, 6 3/4"
- 10021-17** — 17,0 cm, 6 3/4"
- 10022-20** — 20,5 cm, 8"
- 10023-20** — 20,5 cm, 8"

Supercut

- 10024-17 — 17,0 cm, 6 3/4"
- 10025-17 — 17,0 cm, 6 3/4"
- 10026-20 — 20,5 cm, 8"
- 10027-20 — 20,5 cm, 8"



KAYE FACE LIFT

TC

- 10028-14** — 14,5 cm, 5 3/4"
- 10029-14** — 14,5 cm, 5 3/4"
- 10030-18** — 18,5 cm, 7 1/4"
- 10031-18** — 18,5 cm, 7 1/4"
- 10032-23** — 23,0 cm, 9"
- 10033-23** — 23,0 cm, 9"

Supercut

- 10034-14 — 14,5 cm, 5 3/4"
- 10035-14 — 14,5 cm, 5 3/4"
- 10036-18 — 18,5 cm, 7 1/4"
- 10037-18 — 18,5 cm, 7 1/4"
- 10038-23 — 23,0 cm, 9"
- 10039-23 — 23,0 cm, 9"

Face Lift Scheren  
 Face Lift Scissors  
 Tijeras Face Lift  
 Forbici Face Lift



FREEMAN FACE LIFT

- 10040-18      — 18 cm, 7"
- 10041-18 TC      — 18 cm, 7"
- 10042-18 Supercut      — 18 cm, 7"



PECK JOSEPH

- 10044-14      — 14,5 cm, 5 3/4"
- 10045-14      — 14,5 cm, 5 3/4"
- 10046-14 TC      — 14,5 cm, 5 3/4"
- 10047-14 TC      — 14,5 cm, 5 3/4"
- 10048-14 Supercut      — 14,5 cm, 5 3/4"
- 10049-14 Supercut      — 14,5 cm, 5 3/4"

Augenscheren  
 Ophthalmic Scissors  
 Tijeras oculares  
 Forbici oculistiche



WESTCOTT  
 10102-11  
 11 cm, 4 3/8"



WESTCOTT  
 10104-11  
 11 cm, 4 3/8"



NOYES  
 10110-12 10111-12  
 12 cm, 4 3/4"



WECKER  
 11 cm, 4 3/8"



10113-11



10115-11



10117-11



BARRAQUER  
 10119-10 5,5 cm, 2.2"  
 (Colibri)

Mikro-Scheren  
 Micro-Scissors  
 Micro-Tijeras  
 Micro-Forbici

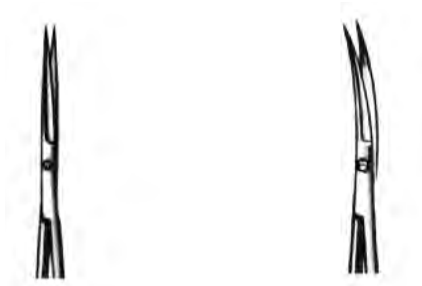

10120-16	16,0 cm, 6 1/4"	10121-16
10120-18	18,5 cm, 7 1/4"	10121-18
10120-22	22,5 cm, 8.9"	10121-22



10122-16	16,0 cm, 6 1/4"	10123-16
10122-18	18,5 cm, 7 1/4"	10123-18
10122-22	22,5 cm, 8.9"	10123-22

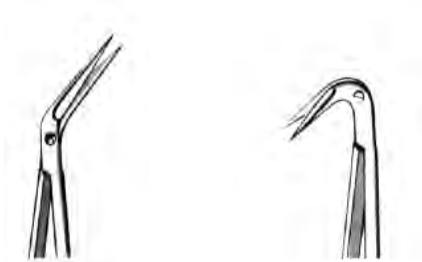

10124-16	16,0 cm, 6 1/4"	10125-16
10124-18	18,5 cm, 7 1/4"	10125-18
10124-22	22,5 cm, 8.9"	10125-22

Circumflex



Mikro-Scheren  
Micro-Scissors  
Micro-Tijeras  
Micro-Forbici



25°

10126-25

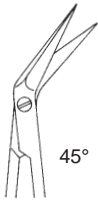

45°

10126-45

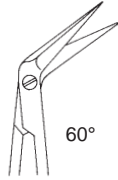

60°

10126-60

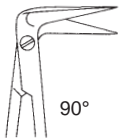

90°

10126-90

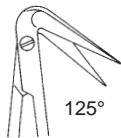

125°

10126-00



Reda  
18 cm, 7"



25°

10127-25



45°

10127-45

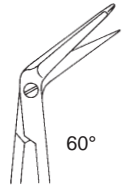

60°

10127-60

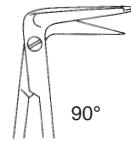

90°

10127-90



125°

10127-00

Mikro-Scheren  
 Micro-Scissors  
 Micro-Tijeras  
 Micro-Forbici



10128-09  
 9 cm, 3 1/2"



10128-15 15 cm, 6"  
 gerade  
 straight  
 rectas  
 rette

10129-15 15 cm, 6"  
 gebogen  
 curved  
 curvas  
 curvo

10130-15 15 cm, 6"  
 gebogen, 1 Schneide gezahnt  
 curved, 1 blade toothed  
 curvas, 1 hoja dentada  
 curva, 1 lama dentellata

10128-15 - 10130-15  
 15 cm, 6"

halbscharf  
 semi-sharp  
 medio roma  
 lame semi smusse



Hepp-Scheidel  
 10131-14 14 cm, 5 1/2"  
 10131-16 16 cm, 6 1/4"



Hepp-Scheidel  
 10132-18  
 18 cm, 7"



Hepp-Scheidel  
 10137-01  
 18 cm, 7"  
 spitz  
 pointed  
 agudas  
 acute

Hepp-Scheidel  
 10137-02  
 18 cm, 7"  
 stumpf  
 blunt  
 romas  
 smusse

Augen-, Mikroscheren  
 Ophthalmic, Micro Scissors  
 Tijeras oculares, micro tijeras  
 Forbici oculistiche, micro chirurg.

Iridektomie, Iridectomy, Iridectomía, iridectomia



CASTROVIEJO  
 10133-10 10 cm, 4"



CASTROVIEJO  
 10135-10 10 cm, 4"



VANNAS  
 10140-08 8 cm, 3 1/8"



VANNAS  
 10141-08 8 cm, 3 1/8"



10142-08  
 kniegebogen  
 angular  
 acodada  
 angolate



10143-08  
 aufgewinkelt  
 angled up  
 acodada hacia arriba  
 angolate verso l'alto

Hornhautscheren, Corneal scissors, Tijeras corneales, Forbici corneali



CASTROVIEJO  
 10151-11 11 cm, 4 3/8"



CASTROVIEJO  
 10153-11 11 cm, 4 3/8"



CASTROVIEJO  
 10155-11 11 cm, 4 3/8"

Mikro-Scheren  
 Micro-Scissors  
 Micro-Tijeras  
 Micro-Forbici



Reda  
 10202-18 - 10203-18  
 18 cm, 7"



GOMEL



10313-14  
 14 cm  
 5 1/2"



10313-16  
 16 cm  
 6 1/4"

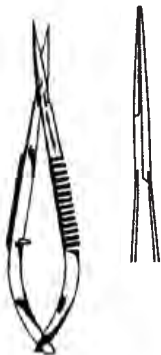

Reda micro  
 10320-09  
 9 cm, 3 1/2"



Reda  
 10330-19 - 10333-19  
 18,5 cm, 7 1/4"



10330-19



10331-19



10333-19

Anatomische und chirurgische Pinzetten  
 Dressing and Tissue Forceps  
 Pinzas de disección, sin/con dientes  
 Pinze per dissezione, chirurgiche/anatomiche

STANDARD



USA

STILLE

cm		11102-10			
10,5	4 1/4"	11102-11			
11,5	4 1/2"				
12,0	4 3/4"	11102-13			11104-12
13,0	5 1/8"	11102-14	11103-14		11104-13
14,5	5 3/4"				11104-14
15,0	6"				
15,5	6"	11102-16			11104-15
16,0	6 1/4"	11102-18			
18,0	7"	11102-20			11104-18
20,0	8"				
21,0	8 1/4"	11102-25			11104-21
25,0	10"	11102-30			11104-25
30,0	12"				

schmal  
 narrow  
 estrecha  
 stretta



POTTS-SMITH



POTTS-SMITH  
 1x2

cm					
10,5	4 1/4"				
11,5	4 1/2"	11110-11			
12,0	4 3/4"				
13,0	5 1/8"	11110-13			
14,5	5 3/4"	11110-14	11114-14 TC		
15,0	6"				
15,5	6"				
16,0	6 1/4"	11110-16	11114-16 TC		
18,0	7"	11110-18		11112-18	11116-18 TC
20,0	8"	11110-20	11114-20 TC		11126-18
21,0	8 1/4"			11112-21	11116-21 TC
25,0	10"	11110-25	11114-25 TC	11112-25	11116-25 TC
30,0	12"	11110-30			11126-25

Chirurgische Pinzetten  
Tissue Forceps  
Pinzas de disección, con dientes  
Pinze per dissezione, chirurgiche

STANDARD



1x2



USA



STILLE



schmal  
narrow  
estrecha  
stretta

1x2

cm				
10,5	4 1/4"	11120-10		
11,5	4 1/2"	11120-11		11130-11
12,0	4 3/4"		11122-12	
13,0	5 1/8"	11120-13	11122-13	11130-13
14,5	5 3/4"	11120-14	11122-14	11130-14
15,0	6"			
15,5	6"		11124-15	
16,0	6 1/4"	11120-16		11130-16
18,0	7"	11120-18	11122-18	11130-18
20,0	8"	11120-20		11130-20
21,0	8 1/4"		11122-21	
25,0	10"	11120-25	11122-25	
30,0	12"	11120-30		



OEHLER



2x3



3x4



4x5

cm				
10,5	4 1/4"			
11,5	4 1/2"		11140-11	
12,0	4 3/4"			
13,0	5 1/8"		11140-13	11150-13
14,5	5 3/4"		11140-14	11150-14
15,0	6"			
15,5	6"			
16,0	6 1/4"	11132-16 TC	11140-16	11150-16
18,0	7"	11132-18 TC	11140-18	11160-16
20,0	8"	11132-20 TC	11140-20	
21,0	8 1/4"			
25,0	10"	11132-25 TC	11140-25	
30,0	12"	11132-30 TC		

Anatomische und chirurgische Pinzetten  
 Dressing and Tissue Forceps  
 Pinzas de disección, sin/con dientes  
 Pinze per dissezione, chirurgiche/anatomiche



ADSON  
 11170-12 12,0 cm, 4 3/4"  
 11170-15 15,0 cm, 6"



ADSON  
 11174-12 TC 12,0 cm, 4 3/4"  
 11174-15 TC 15,0 cm, 6"



ADSON micro  
 11176-12 12,0 cm, 4 3/4"  
 11176-15 15,0 cm, 6"



Adson-DeBakey atraumatic  
 11177-12  
 12,0 cm, 4 3/4"



ADSON  
 11178-12  
 12,0 cm, 4 3/4"

1x2



ADSON  
 11179-12  
 12 cm, 4 3/4"

2x3

Anatomische und chirurgische Pinzetten  
 Dressing and Tissue Forceps  
 Pinzas de disección, sin/con dientes  
 Pinze per dissezione, anatomiche/chirurgiche



1x2

ADSON

11180-12 12,0 cm, 4 3/4"  
 11180-15 15,0 cm, 6"



1x2

ADSON

11181-12 TC 12,0 cm, 4 3/4"  
 11181-15 TC 15,0 cm, 6"



1x2

ADSON micro

11186-12 12,0 cm, 4 3/4"  
 11186-15 15,0 cm, 6"



1x2

ADSON

11187-12  
 12 cm, 4 3/4"



7x7

ADSON-BROWN

11188-12 12,0 cm, 4 3/4"  
 11188-15 15,0 cm, 6"  
 11189-12 TC 12,0 cm, 4 3/4"



Anatomische und chirurgische Pinzetten  
 Dressing and Tissue Forceps  
 Pinzas de disección, sin/con dientes  
 Pinze per dissezione, chirurgiche/anatomiche



9x9

**BROWN**  
 11189-15 15,0 cm, 6"  
 11189-20 20,0 cm, 8"  
 11189-25 25,0 cm, 10"



**GRAEFE**  
 11190-10 10,5 cm, 4.1"



1x2

**WAUGH**  
 11187-18 18 cm, 7"  
 11187-20 20 cm, 8"  
 11187-25 25 cm, 10"  
 11187-30 30 cm, 11 3/4"



17 cm  
 6 3/4"

**CUSHING**  
 11220-17  
 11224-17 TC  
 17,0 cm, 6 3/4"



11221-17



17 cm  
 6 3/4"

**CUSHING**  
 11222-17  
 11225-17 TC

1x2



11223-17

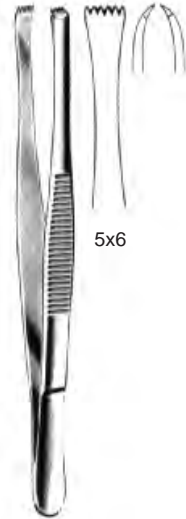

5x6

**LERCHE**  
 11232-15  
 15,0 cm, 6"

Anatomische und chirurgische Pinzetten, Faßpinzetten  
 Dressing and Tissue Forceps  
 Pinzas de disección, sin/con dientes  
 Pinze per dissezione, chirurgiche/anatomiche



BROPHY  
 11231-20  
 20,0 cm, 8"



BROPHY  
 11233-20  
 20,0 cm, 8"



11234-20



11235-20

BROPHY



4x5

ADLERKREUTZ  
 11236-15 15,0 cm, 6"  
 11236-20 20,0 cm, 8"



DUEHRSEN  
 11237-20  
 20 cm, 8"



1x2

LANE  
 11240-14  
 14,5 cm, 5 3/4"



2x3

LANE  
 11242-14  
 14,5 cm, 5 3/4"

Anatomische und chirurgische Pinzetten, Faßpinzetten  
 Dressing and Tissue Forceps  
 Pinzas de disección, sin/con dientes  
 Pinze per dissezione, chirurgiche/anatomiche



FERRIS-SMITH  
 11246-18  
 18,0 cm, 7"



FERRIS-SMITH  
 11248-18  
 18,0 cm, 7"



DUVAL  
 11250-14  
 14,5 cm, 5 3/4"



COLLIN-DUVAL  
 11252-20  
 20,0 cm, 8"



Russ. Mod.  
 11256-15 15,0 cm, 6"  
 11256-20 20,0 cm, 8"  
 11256-25 25,0 cm, 10"



McINDOE  
 11257-15  
 15,0 cm, 6"



McINDOE  
 11258-15 15,0 cm, 6"  
 11259-15 TC 15,0 cm, 6"

Anatomische und chirurgische Pinzetten  
 Dressing and Tissue Forceps  
 Pinzas de disección, sin/con dientes  
 Pinze per dissezione, chirurgiche/anatomiche



SEMKEN  
 11260-12 12,5 cm, 5"  
 11260-15 15,5 cm, 6"  
 11261-15 TC 15,5 cm, 6"



SEMKEN  
 11270-12 12,5 cm, 5"  
 11270-15 15,5 cm, 6"  
 11271-15 TC 15,5 cm, 6"  
 11271-18 TC 18 cm, 7"



GILLIES  
 11272-15 15,5 cm, 6"  
 11273-15 TC 15,5 cm, 6"



15,5 cm, 6"



11274-06  
 0,6 mm



11274-08  
 0,8 mm



11274-10  
 1,0 mm



GERALD  
 11302-17 17,5 cm, 6,9"  
 11302-23 23,0 cm, 9"  
 11304-17 TC 17,0 cm, 6 3/4"



GERALD  
 11303-17  
 17,5 cm, 6,9"

Anatomische und chirurgische Pinzetten  
 Dressing and Tissue Forceps  
 Pinzas de disección, sin/con dientes  
 Pinze per dissezione, chirurgiche/anatomiche



GERALD  
 11305-17  
 17,5 cm, 6.9"



GERALD  
 11310-17 17,5 cm, 6.9"  
 11312-17 TC 17,5 cm, 6.9"



GERALD  
 11311-17  
 17,5 cm, 6.9"



CUSHING-Taylor  
 11312-18 TC  
 18,5 cm, 7 1/4"



GERALD  
 11313-17  
 17,5 cm, 6.9"



11314-01  
 17 cm, 6 3/4"



11314-02  
 17 cm (6 3/4")  
 1x2



11315-01  
 17 cm, 6 3/4"



11315-02  
 17 cm (6 3/4")  
 1x2

Anatomische und chirurgische Pinzetten  
 Dressing and Tissue Forceps  
 Pinzas de disección, sin/con dientes  
 Pinze per dissezione, chirurgiche/anatomiche

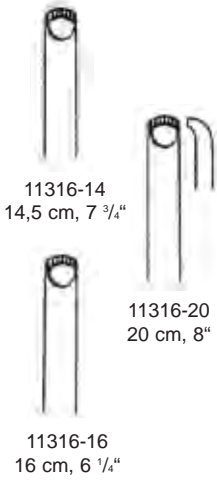

11316-14  
14,5 cm, 7 3/4"

11316-20  
20 cm, 8"

11316-16  
16 cm, 6 1/4"

DURANTE



- 11317-12 1x2
- 11317-23 2x3
- 11319-12 TC 1x2

11317-00  
ohne Zähne  
without teeth  
sin dientes  
senza denti

BONNEY  
18 cm, 7"

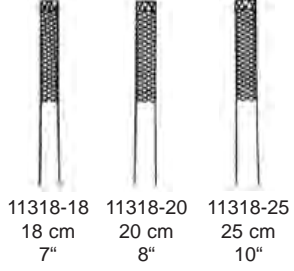

11318-18  
18 cm  
7"

11318-20  
20 cm  
8"

11318-25  
25 cm  
10"

STILLE-BARRAYA  
3x4



11319-14  
14,5 cm, 5 3/4"

OCHSNER



SINGLEY  
11320-18 18 cm 7"  
11320-23 23 cm 9"

Anatomische und chirurgische Pinzetten  
 Dressing and Tissue Forceps  
 Pinzas de disección, sin/con dientes  
 Pinze per dissezione, chirurgiche/anatomiche



NELSON  
 11322-15 15 cm 6"  
 11322-18 18 cm 7"  
 11322-23 23 cm 9"



WANGENSTEEN  
 11324-23  
 23 cm 9"



11325-15 TC  
 15 cm, 6"



11325-23 TC  
 23 cm, 9"



11325-25 TC  
 25 cm, 10"

WANGENSTEEN



11326-23

MAYO  
 23 cm, 9"



1x2 Zähne



11328-15  
 15 cm, 6"



11328-20  
 20 cm, 8"

STRASSBURGER  
 MODELL

Splitterpinzetten  
Splinter Forceps  
Pinzas para espinas  
Pinze per schegge

Fig.: 1



11401-01  
12 cm, 4 3/4"

3



11403-03  
12 cm, 4 3/4"

3c



11403-04  
11 cm, 4 3/8"

Fig.: 4



11404-04  
11 cm, 4 3/8"

5



11405-05  
11 cm, 4 3/8"

7



11407-07  
12 cm, 4 3/4"



Splitterpinzetten  
 Splinter Forceps  
 Pinzas para espinas  
 Pinze per schegge



11802-09 9,0 cm, 3 1/2"  
 11802-10 10,5 cm, 4.1"  
 11802-11 11,5 cm, 4 1/2"



FEILCHENFELD  
 11810-07 7,5 cm, 3"  
 11810-09 9,0 cm, 3 1/2"  
 11810-11 11,5 cm, 4 1/2"



HUNTER  
 11812-10 10,5 cm, 4.1"



HUNTER  
 11813-10  
 10,5 cm, 4.1"



HUNTER  
 11815-12  
 12,5 cm, 5"



CARMALT  
 11816-10  
 10,5 cm, 4.1"



CARMALT  
 11817-10  
 10,5 cm, 4.1"

Splitterzangen  
Splinter Forceps  
Pinzas para espinas  
Pinze per schegge



PEET  
11821-11  
11,5 cm, 4 1/2"



STIEGLITZ  
11822-13 11823-13  
13,5 cm, 5 1/4"



ARCHER  
11824-14 11825-14  
14 cm, 5 1/2"



VIRTUS (RALK)  
11828-15 11829-15  
15 cm, 6"

Zahnpinzetten  
Dental Forceps  
Pinzas dentales  
Pinze dentali

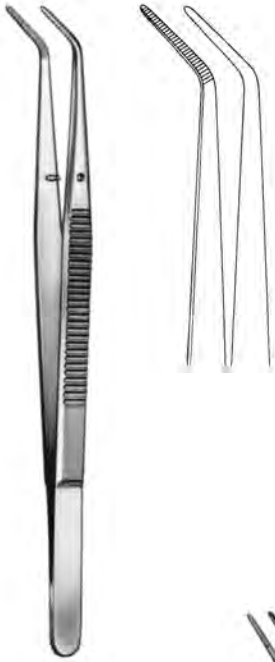

LONDON-COLLEGE  
11900-01  
15 cm 6"



LONDON-COLLEGE  
11901-05  
15 cm 6"

mit Sperre  
with lock  
con cierre  
con fermo



MERIAM  
11910-01  
15 cm 6"

Mikrochirurgie-Pinzetten  
Microsurgery Forceps  
Pinzas para microcirugía  
Pinze per microchirurgia



12102-12  
12 cm, 4 3/4"



12103-12  
12 cm, 4 3/4"



12104-15  
15 cm, 6"



12105-15  
15 cm, 6"



12108-18  
18 cm, 7"



12109-18  
18 cm, 7"

Ultra-Light-Pinzetten  
 Ultra-Light-Forceps  
 Pinzas-Ultra-Ligera  
 Pinza-ultra-leggera

1,5 mm

1,2 mm

1,5 mm

1,5 mm



1/4

12110-15  
 15 cm, 6"



1/4

12110-20  
 20 cm, 8"



1/4

12110-24  
 24 cm, 9 1/2"



1/4

12110-30  
 30 cm, 11 3/4"

Mikrochirurgie-Pinzetten  
Microsurgery Forceps  
Pinzas para microcirugía  
Pinze per microchirurgia

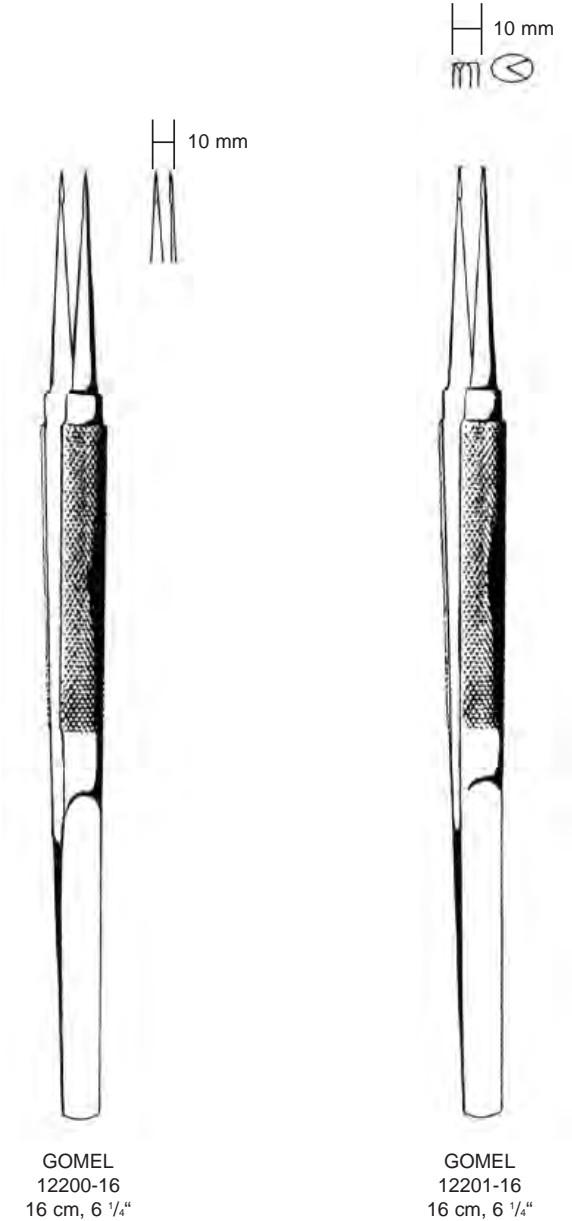

Tumorpinzetten  
Tumor forceps  
Pinzas para tumores  
Pinze per tumori

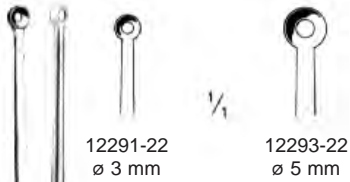

$\frac{1}{2}$

YASARGIL  
12291-22 – 12293-22  
22 cm, 8  $\frac{3}{4}$ "



$\frac{1}{2}$

YASARGIL  
12295-22 – 12297-22  
22 cm, 8  $\frac{3}{4}$ "

Atraumatische Pinzetten  
 Atraumatic Tissue Forceps  
 Pinzas atraumáticas  
 Pinze atraumatiche



DE BAKEY  
 12302-16 16 cm, 6 1/4"  
 12302-20 20 cm, 8"  
 12302-24 24 cm, 9 1/2"



DE BAKEY  
 12306-16 16 cm, 6 1/4"  
 12306-20 20 cm, 8"  
 12306-24 24 cm, 9 1/2"  
 12306-30 30 cm, 11 3/4"



DE BAKEY  
 12308-16 16 cm, 6 1/4"  
 12308-20 20 cm, 8"  
 12308-24 24 cm, 9 1/2"  
 12308-30 30 cm, 11 3/4"



DE BAKEY  
 12309-16 16 cm, 6 1/4"  
 12309-20 20 cm, 8"  
 12309-24 24 cm, 9 1/2"  
 12309-30 30 cm, 11 3/4"



DE BAKEY  
 12304-16 16 cm, 6 1/4"  
 12304-20 20 cm, 8"  
 12304-24 24 cm, 9 1/2"  
 12304-30 30 cm, 11 3/4"



DE BAKEY  
 12310-16 16 cm, 6 1/4"  
 12310-20 20 cm, 8"  
 12310-24 24 cm, 9 1/2"  
 12310-30 30 cm, 11 3/4"



Atraumatische Pinzetten  
 Atraumatic Tissue Forceps  
 Pinzas atraumáticas  
 Pinze atraumatiche

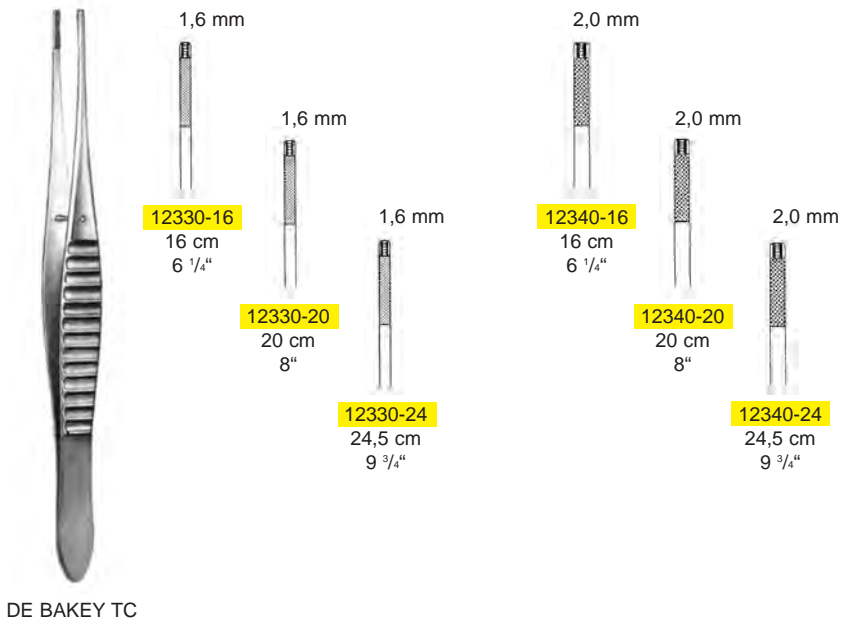
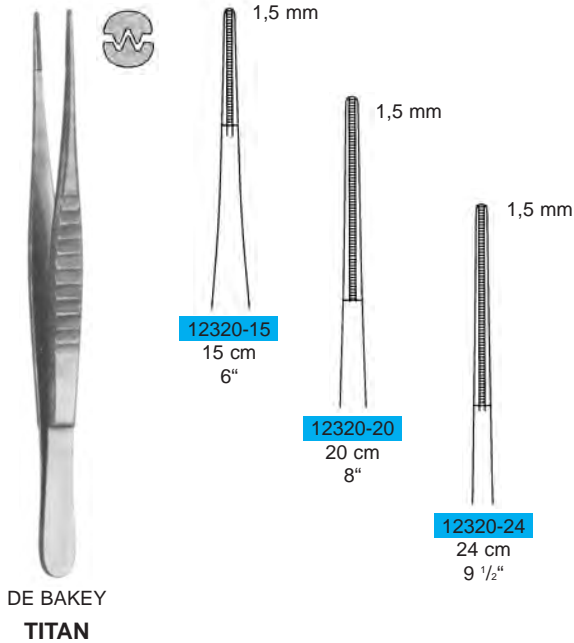

Atrauma-Bulldogklemmen  
 Atrauma-Bulldog Clamps  
 Clamps Atrauma Bulldog  
 Pinze Atrauma Bulldog

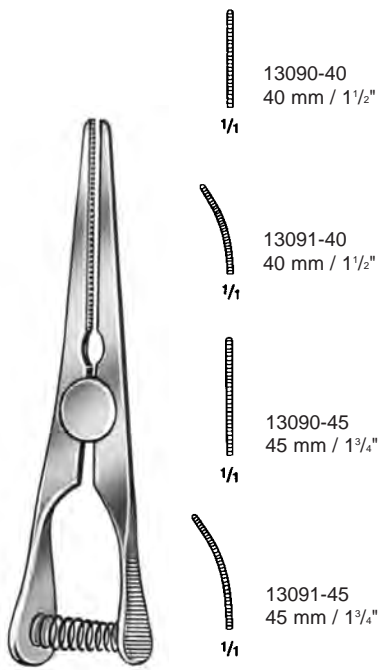

13090-40  
 40 mm  
 1 1/2"

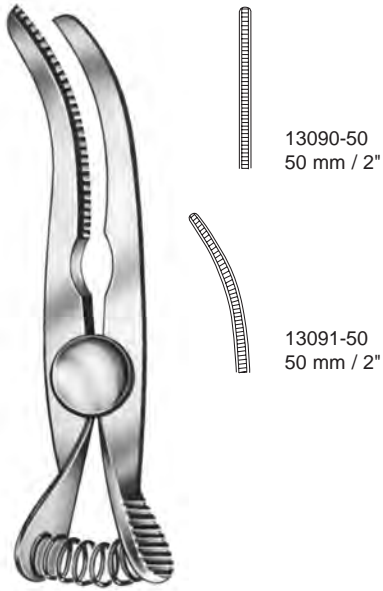

13091-50  
 50 mm  
 2"



13098-06  
 57 mm  
 2 3/8"



13099-07  
 73 mm  
 2 3/4"

Mini-Bulldogklemmen  
 Mini Bulldog Clamps  
 Clamps Bulldog Mini  
 Pinze Bulldog Mini

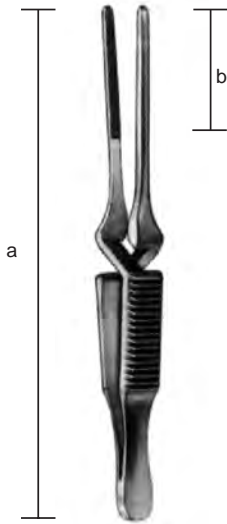

Diethrich

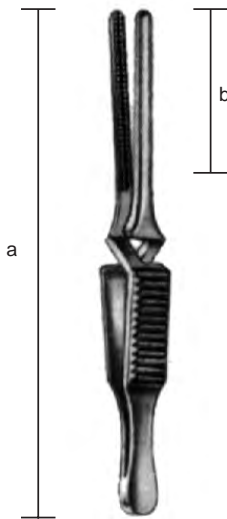
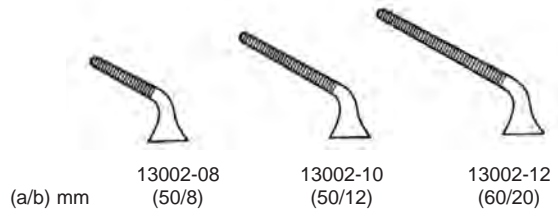
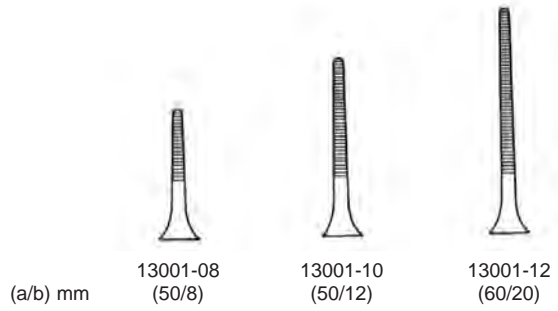

DeBaKey-Diethrich

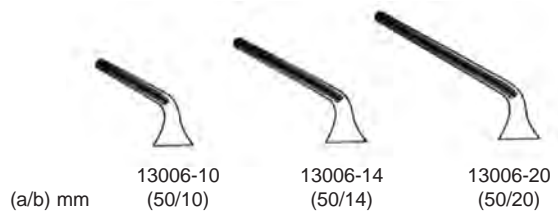
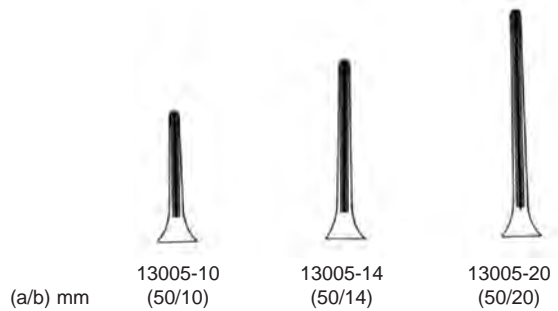

Titan-Atrauma-Bulldogklemmen  
 Titanium Atrauma Bulldog Clamps  
 Titan Clamp Bulldog  
 Titan Pinze Bulldog

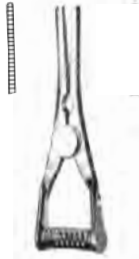

3 cm, 1.2"

Vene  
 Arterie [13010-30](#)  
[13011-30](#)



3,5 cm, 1,4"

[13010-35](#)  
[13011-35](#)



4 cm, 1 1/2"

[13010-40](#)  
[13011-40](#)

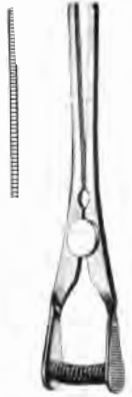

5 cm, 2"

[13010-50](#)  
[13011-50](#)



3 cm, 1.2"

Vena  
 Arteria [13012-30](#)  
[13013-30](#)



3,5 cm, 1,4"

[13012-35](#)  
[13013-35](#)



4 cm, 1 1/2"

[13012-40](#)  
[13013-40](#)



5 cm, 2"

[13012-50](#)  
[13013-50](#)



3 cm, 1.2"

Vene  
 Arterie [13014-30](#)  
[13015-30](#)



3,5 cm, 1,4"

[13014-35](#)  
[13015-35](#)



4 cm, 1 1/2"

[13014-40](#)  
[13015-40](#)

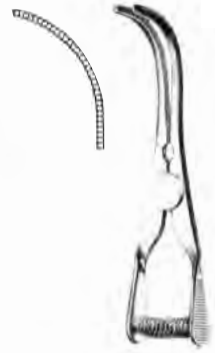

5 cm, 2"

[13014-50](#)  
[13015-50](#)

Atrauma-Bulldogklemmen  
 Atrauma Bulldog Clamps  
 Clamps Atrauma Bulldog  
 Pinze Atrauma Bulldog



DE BAKEY



13092-07  
 7,5 cm  
 3"



13092-08  
 8,5 cm  
 3.4"



13092-10  
 10,5 cm  
 4"



13092-12  
 12 cm  
 4 3/4"



13093-07  
 7 cm  
 2 3/4"



13093-08  
 8 cm  
 8 1/8"



13093-10  
 10 cm  
 4"



13093-12  
 11,5 cm  
 4 1/2"



GLOVER



13096-06  
 6 cm  
 2 1/4"



13096-07  
 7 cm  
 2 3/4"



13096-09  
 9 cm  
 3 1/2"



13096-11  
 11 cm  
 4 3/8"



13097-06  
 5,5 cm  
 2"



13097-07  
 6,5 cm  
 2 1/2"



13097-09  
 8,5 cm  
 3 1/4"



13097-11  
 10,5 cm  
 4"

Gefäßklemmen, Bulldogklemmen, Arterienklemmen  
 Hemostatic Forceps  
 Pinzas hemostáticas  
 Pinze serrafina, Pinze emostatiche



DIEFFENBACH  
 13102-04 3,5 cm, 1.4"  
 13102-05 5,5 cm, 2.2"



DIEFFENBACH  
 13103-04 3,5 cm, 1.4"  
 13103-05 5,5 cm, 2.2"

gerade  
 straight  
 recta  
 rette



gebogen  
 curved  
 curva  
 curve

JOHNS-HOPKINS

13110-50	5,0 cm, 2"	13111-50
13110-55	5,5 cm, 2.2"	13111-55
13110-65	6,5 cm, 2.6"	13111-65
13110-70	7,0 cm, 2 3/4"	13111-70
13110-75	7,5 cm, 3"	13111-75
13110-90	9,0 cm, 3 1/2"	13111-90

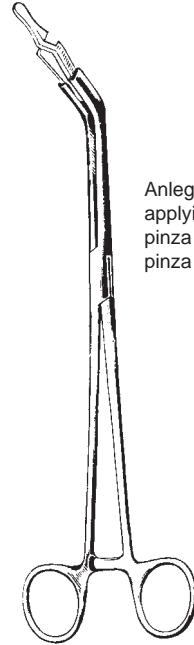

Anlegezange  
 applying forceps  
 pinza para poner  
 pinza applicatrice

13115-00  
 23 cm, 9"

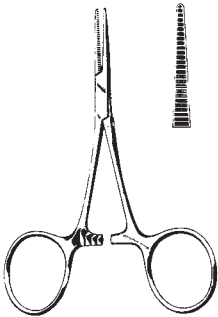

HARTMANN  
 13210-10  
 10 cm, 4"

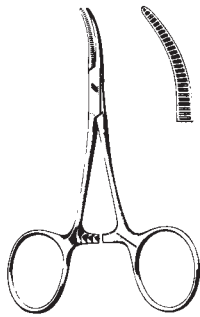

HARTMANN  
 13211-10  
 10 cm, 4"

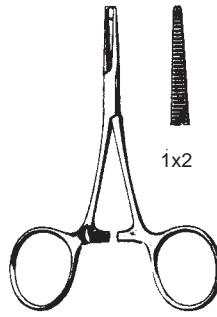

HARTMANN  
 13212-10  
 10 cm, 4"

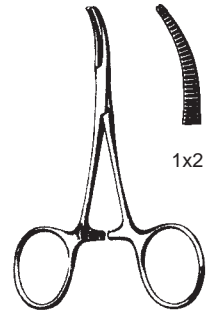

HARTMANN  
 13213-10  
 10 cm, 4"

Micro-HARTMANN  
 13214-10  
 10 cm, 4"

Micro-HARTMANN  
 13215-10  
 10 cm, 4"

Arterienklemmen  
 Hemostatic Forceps  
 Pinzas hemostáticas  
 Pinze emostatiche

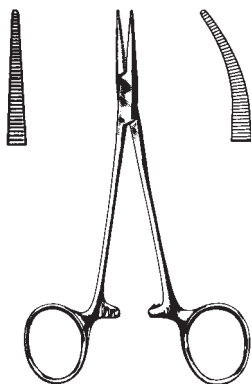

cm TITAN  
 12,5 5" 13224-12  
 14,0 5 1/2"  
 18,0 7"  
 21,0 8 1/4"

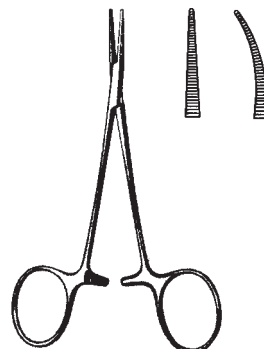

— HALSTED-MOSQUITO micro —  
 13222-12 12,5 cm, 5" 13223-12  
 JACOBSON micro  
 13226-12 12,0 cm, 4 3/4" 13227-12

TITAN — HALSTED-MOSQUITO —  
 13224-12 13220-12 12,5 cm, 5" 13221-12  
 13220-14 14,0 cm, 5 1/2" 13221-14  
 13220-18 18,0 cm, 7" 13221-18  
 13220-21 21,0 cm, 8 1/4" 13221-21

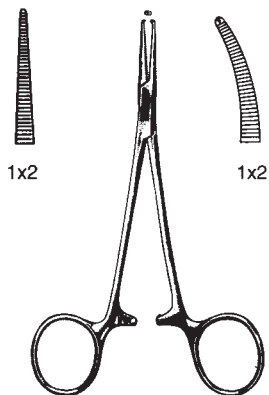

— HALSTED-MOSQUITO —  
 13230-12 12,5 cm, 5" 13231-12  
 13230-14 14,0 cm, 5 1/2" 13231-14  
 13230-18 18,0 cm, 7" 13231-18  
 13230-21 21,0 cm, 8 1/4" 13231-21

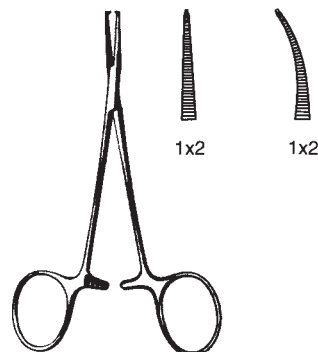

— HALSTED-MOSQUITO micro —  
 13232-12 13233-12

Arterienklemmen  
 Hemostatic Forceps  
 Pinzas hemostáticas  
 Pinze emostatiche

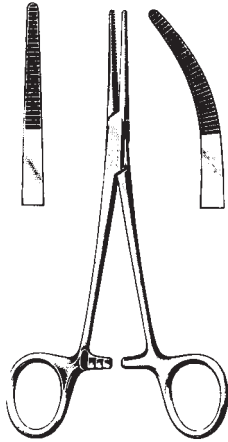

KELLY

- |          |               |          |
|----------|---------------|----------|
| 13240-14 | 14 cm, 5 1/2" | 13241-14 |
| 13240-18 | 18 cm, 7"     | 13241-18 |
| 13244-14 | 14 cm, 5 1/2" | 13245-14 |

TITAN

TITAN

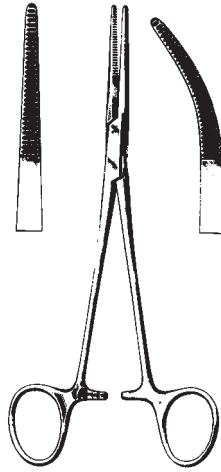

KELLY-RANKIN

- |          |               |          |
|----------|---------------|----------|
| 13242-16 | 16 cm, 6 1/4" | 13243-16 |
|----------|---------------|----------|

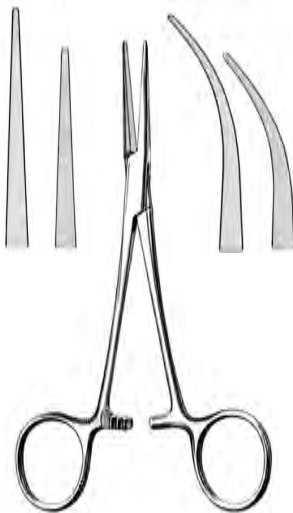

COLLER-CRILE

- |          |               |          |
|----------|---------------|----------|
| 13256-14 | 14 cm, 5 1/2" | 13257-14 |
| 13258-16 | 16 cm, 6 1/4" | 13259-16 |

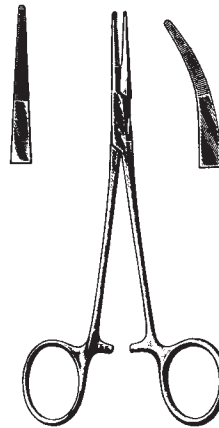

PROVIDENCE-HOSPITAL

- |          |               |          |
|----------|---------------|----------|
| 13270-14 | 14 cm, 5 1/2" | 13271-14 |
|----------|---------------|----------|



Arterienklemmen  
 Hemostatic Forceps  
 Pinzas hemostáticas  
 Pinze emostatiche

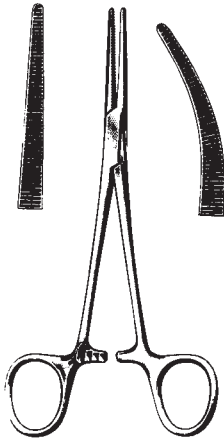

CRILE  
 13250-14 14 cm, 5 1/2" 13251-14  
 13250-18 18 cm, 7" 13251-18  
 13254-14 14 cm, 5 1/2" 13255-14  
 TITAN TITAN

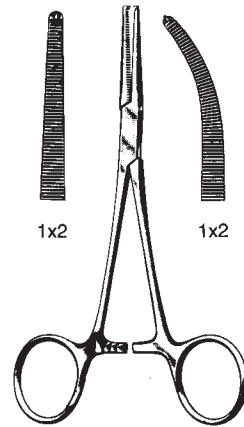

CRILE  
 13260-14 14 cm, 5 1/2" 13261-14

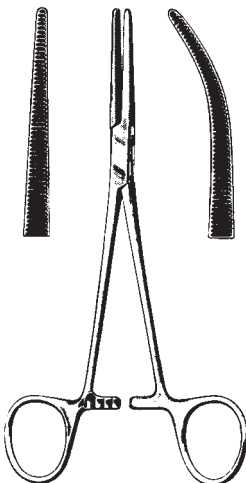

CRILE-RANKIN  
 13262-16 16 cm, 6 1/4" 13263-16

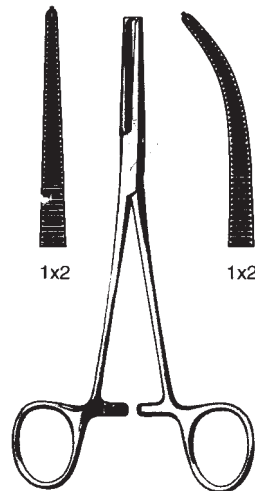

CRILE-RANKIN  
 13264-16 16 cm, 6 1/4" 13265-16

Arterienklemmen  
 Hemostatic Forceps  
 Pinzas hemostáticas  
 Pinze emostatiche

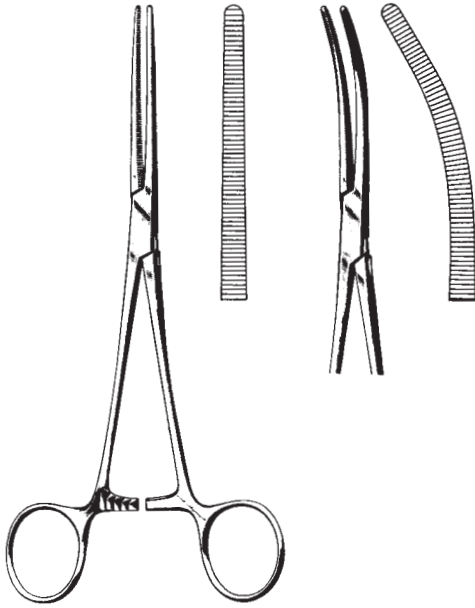

ROCHESTER-PEAN

13310-13	13 cm, 5 1/8"	13311-13
13310-14	14 cm, 5 1/2"	13311-14
13310-16	16 cm, 6 1/4"	13311-16
13310-18	18 cm, 7"	13311-18
13310-20	20 cm, 8"	13311-20
13310-22	22 cm, 8 3/4"	13311-22
13310-24	24 cm, 9 1/2"	13311-24
13310-26	26 cm, 10 1/4"	13311-26
13310-30	30 cm, 11 3/4"	13311-30

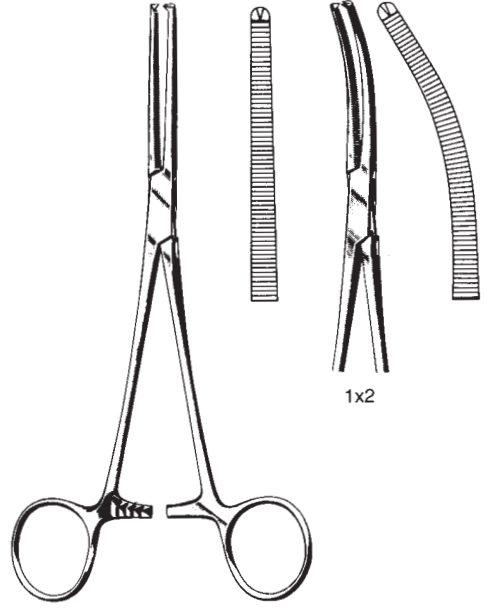

ROCHESTER-OGHSNER

13320-13	13 cm, 5 1/8"	13321-13
13320-14	14 cm, 5 1/2"	13321-14
13320-16	16 cm, 6 1/4"	13321-16
13320-18	18 cm, 7"	13321-18
13320-20	20 cm, 8"	13321-20
13320-22	22 cm, 8 3/4"	13321-22
13320-24	24 cm, 9 1/2"	13321-24
13320-26	26 cm, 10 1/4"	13321-26
13320-30	30 cm, 11 3/4"	13321-30

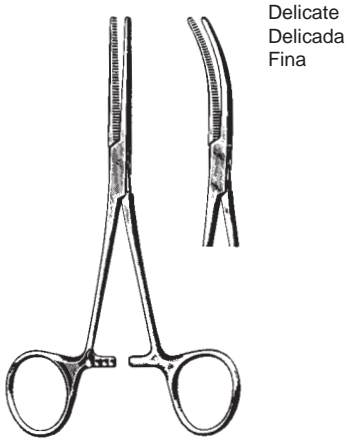

PEAN

13312-14	14 cm, 5 1/2"	13313-14
13312-16	16 cm, 6 1/4"	13313-16

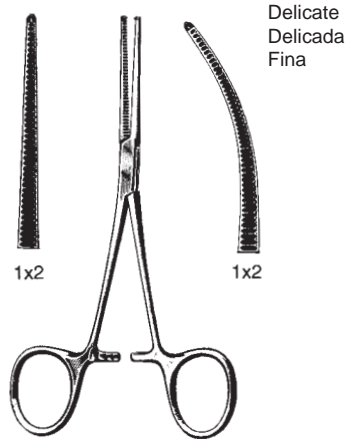

KOCHER

13322-14	14 cm, 5 1/2"	13323-14
13322-16	16 cm, 6 1/4"	13323-16

Arterienklemmen  
 Hemostatic Forceps  
 Pinzas hemostáticas  
 Pinze emostatiche

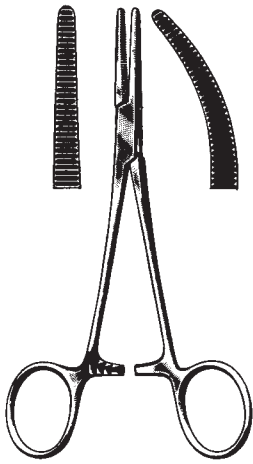

SPENCER-WELLS

13330-13	13 cm, 5"	13331-13
13330-15	15 cm, 6"	13331-15
13330-18	18 cm, 7"	13331-18
13330-20	20 cm, 8"	13331-20

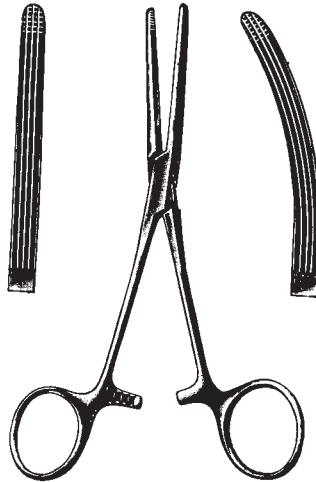

ROCHESTER-CARMALT

13340-16	16 cm, 6 1/4"	13341-16
13340-20	20 cm, 8"	13341-20

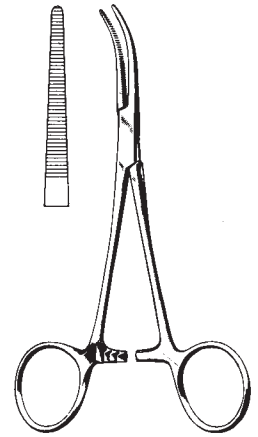

DANDY

13345-12	12 cm, 4 3/4"
13345-14	14 cm, 5 1/2"

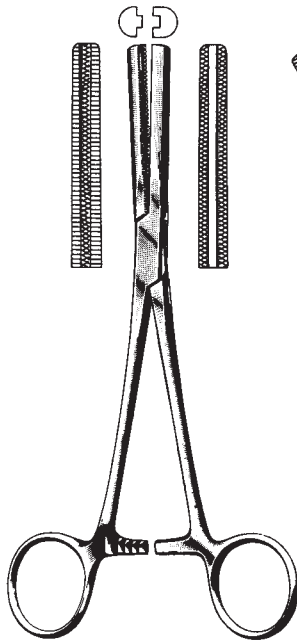

FERGUSSON

13350-16	16 cm, 6 1/4"	13351-16
13350-20	20 cm, 8"	13351-20

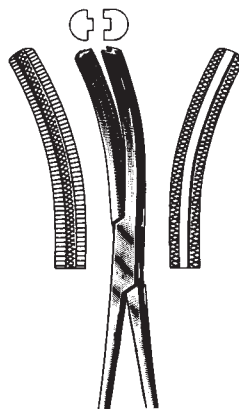

LOVELACE

13356-15	15,5 cm, 6"
----------	-------------

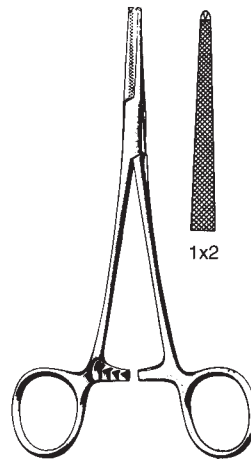

PENNINGTON

13358-15	15,5 cm, 6"
13358-20	20,0 cm, 8"

Fasszangen  
 Grasping Forceps  
 Pinza para agarrar órganos y tejidos  
 Pinze da presa

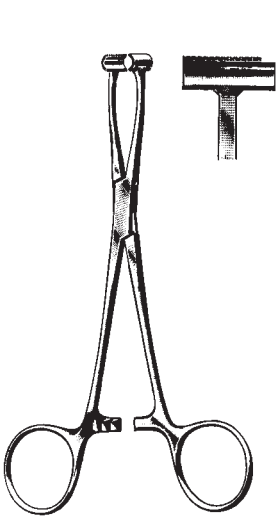

PRATT  
 13360-15 15 cm, 6"

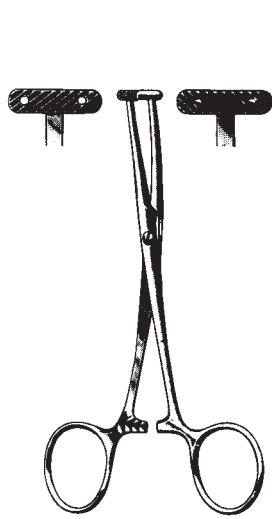

MARTEL  
 13364-14 14 cm, 5 1/2"

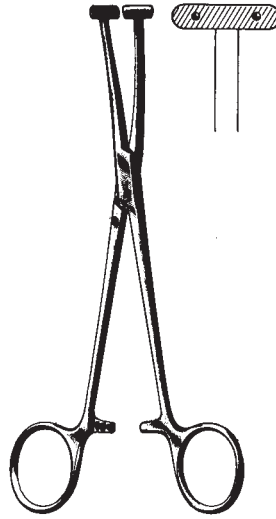

WILLET MARTEL  
 13366-19 19 cm, 7 1/2"

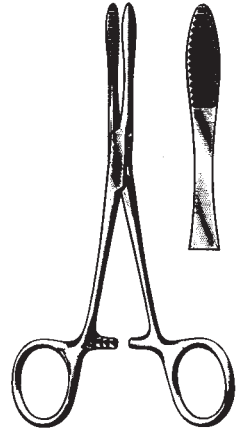

PEAN  
 13368-14 14 cm, 5 1/2"  
 13368-16 16 cm, 6 1/4"

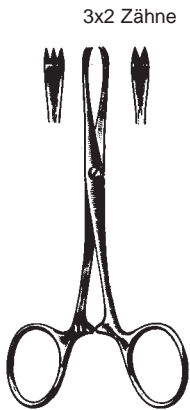

CHAPUT  
 13370-13  
 13 cm, 5 1/8"

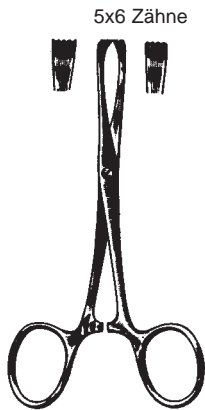

TUFFIER  
 13372-13  
 13 cm, 5 1/8"

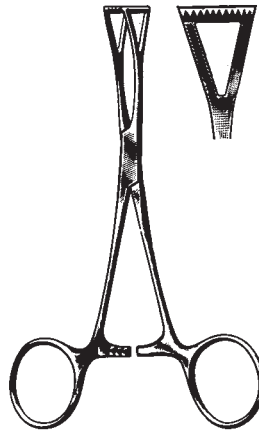

COLLIN  
 13374-14  
 14 cm, 5 1/2"

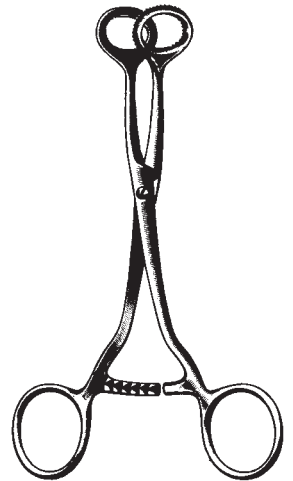

COLLIN  
 13376-16  
 16 cm, 6 1/4"

Organ- und Gewebefasszange, Arterienklemmen  
 Organ- and Tissue Grasping Forceps, Hemostatic Forceps  
 Pinza para agarrar órganos y tejidos, Pinzas hemostáticas  
 Pinza per tessuti e organi, Pinze emostatiche



REDA  
 ATRAUMA  
 13377-25 - 13377-26



13377-25  
 25 cm, 10"



13377-26  
 26 cm, 10 1/4"

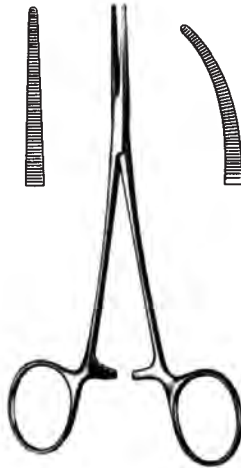

LERICHE  
 13380-15 15 cm, 6" 13381-15

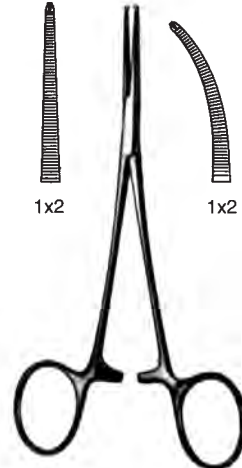

LERICHE  
 13382-15 15 cm, 6" 13383-15

Arterienklemmen  
 Hemostatic Forceps  
 Pinzas hemostáticas  
 Pinze emostatiche



BENGOLEA

13384-20 20 cm, 8" 13385-20  
 13384-26 26 cm, 10 1/4" 13385-26

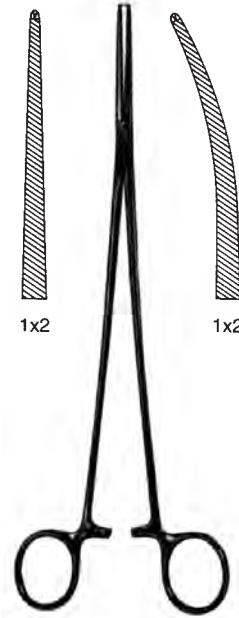

BENGOLEA

13386-20 20 cm, 8" 13387-20  
 13386-26 26 cm, 10 1/4" 13387-26

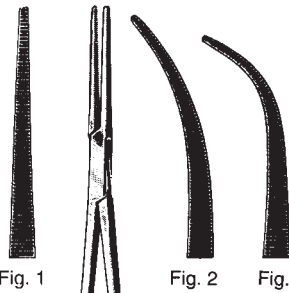

Fig. 1

Fig. 2

Fig. 3

13390-20  
 (1x2) 13394-20

13391-20 13393-20  
 13395-20 (1x2)

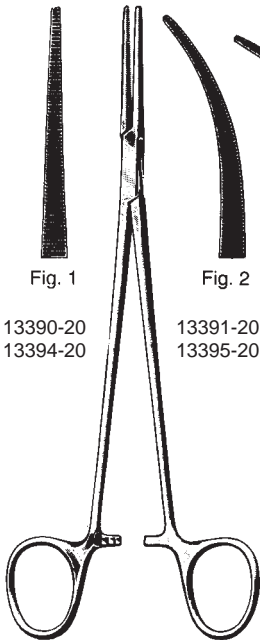

HEISS  
 20 cm, 8"

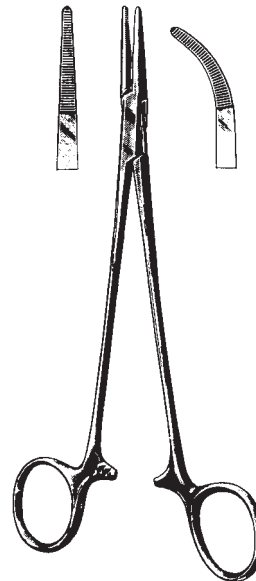

ADSON

13410-18 18,5 cm, 7 1/4" 13411-18

Arterienklemmen  
 Hemostatic Forceps  
 Pinzas hemostáticas  
 Pinze emostatiche

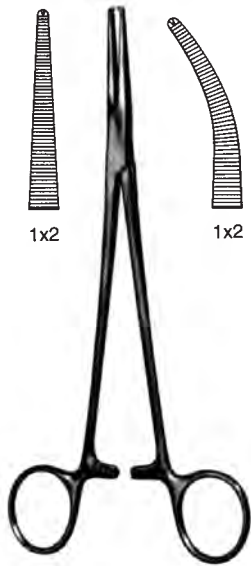

ADSON  
 13412-18 18,5 cm, 7 1/4" 13413-18



Fuchsig  
 13414-20 19 cm, 7 1/2"



ADSON BABY  
 13415-14 14,0 cm, 5 1/2"  
 13415-18 18,5 cm, 7 1/4"



NISSEN  
 13416-18 18,5 cm, 7 1/4"

Arterienklemmen  
 Hemostatic Forceps  
 Pinzas hemostáticas  
 Pinze emostatiche



OVERHOLT-BABY  
 13420-14  
 14 cm, 5 1/2"



OVERHOLT-GEISSENDOERFER  
 21 cm, 8 1/4"

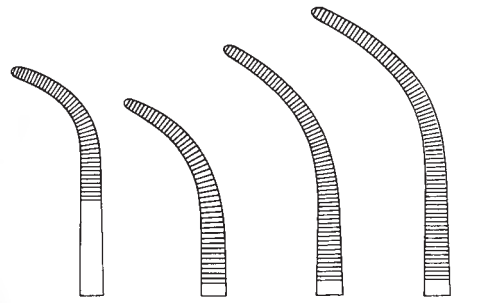

Fig. 1  
 13421-01

Fig. 2  
 13421-02  
 13425-02  
 26 cm  
 10 1/4"

Fig. 3  
 13421-03  
 13425-03  
 27 cm  
 10 1/2"

Fig. 4  
 13421-04  
 13425-04  
 27,5 cm  
 10,8"

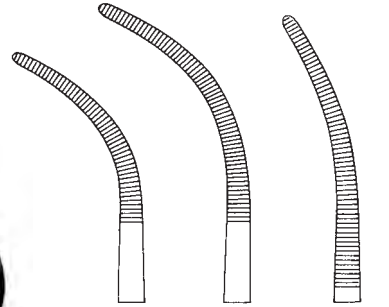

Fig. 5  
 13421-05  
 13425-05  
 27 cm  
 10 1/2"

Fig. 6  
 13421-06  
 13425-06  
 28 cm  
 11"

Fig. 7  
 13421-07



OVERHOLT

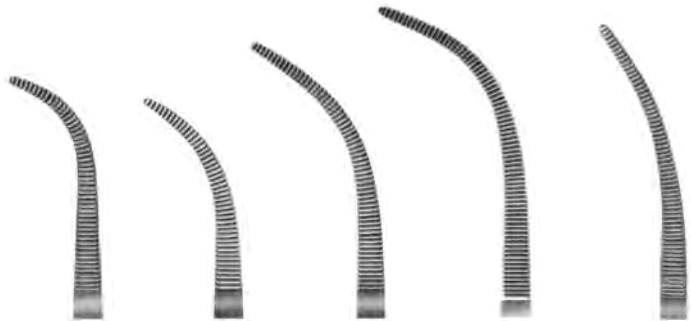

13422-00  
 21,5 cm  
 8 1/2"  
 Fig. ①

13422-01  
 21 cm  
 8 1/4"  
 ①

13422-02  
 22 cm  
 8 3/4"  
 ②

13422-03  
 23 cm  
 9"  
 ③

13422-06  
 22,5 cm  
 8,9"  
 ⑥



Arterienklemmen  
 Hemostatic Forceps  
 Pinzas hemostáticas  
 Pinze emostatiche



OVERHOLT-MIXTER  
 13428-21  
 21,5 cm, 8 1/2"



GEMINI

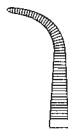

13431-13  
 13 cm  
 5 1/8"

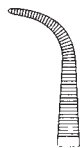

13431-16  
 16 cm  
 6 1/4"

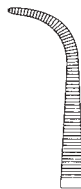

13431-18  
 18 cm  
 7"

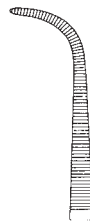

13431-20  
 20 cm  
 8"



13431-23  
 23 cm  
 9"



13431-25  
 25 cm  
 10"

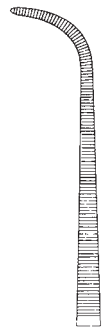

13431-28  
 28 cm  
 11"

Arterienklemmen  
 Hemostatic Forceps  
 Pinzas hemostáticas  
 Pinze emostatiche



BIRKETT



13432-19 18,5 cm 7 1/4"  
 13433-19 18,5 cm 7 1/4"



BRIDGE



13434-28 27,5 cm 10 3/4"  
 13435-28 27,5 cm 10 3/4"



MIXTER

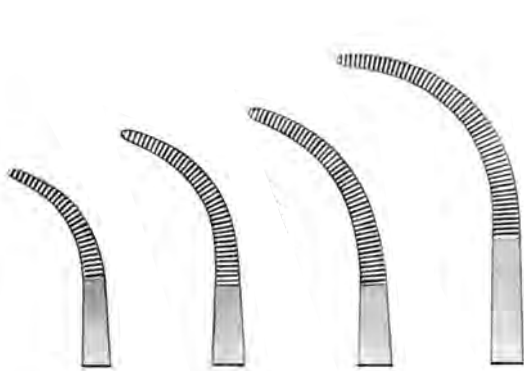

13438-01 18,5 cm 7 1/4"  
 13438-02 21 cm 8 1/4"  
 13438-03 21,5 cm 8 1/2"  
 13438-04 22 cm 8 3/4"

Arterienklemmen  
 Hemostatic Forceps  
 Pinzas hemostáticas  
 Pinze emostatiche



RUMEL  
 23 cm, 9"

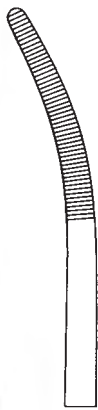

13441-01

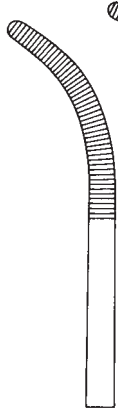

13441-02

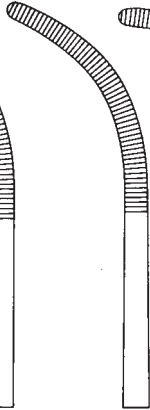

13441-03

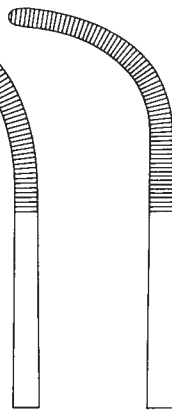

13441-04



WIKSTROEM  
 13447-20  
 20,5 cm, 8"



13442-21 21 cm, 8 1/4"  
 13442-26 26 cm, 10 1/4"

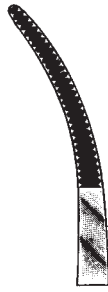

21 cm, 8 1/4" 13443-21  
 26 cm, 10 1/4" 13443-26



1x2

13444-21 21 cm, 8 1/4"  
 13444-26 26 cm, 10 1/4"

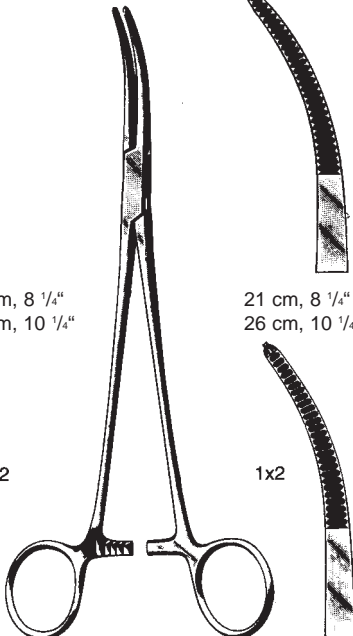

TOENNIS

1x2

21 cm, 8 1/4" 13445-21  
 26 cm, 10 1/4" 13445-26

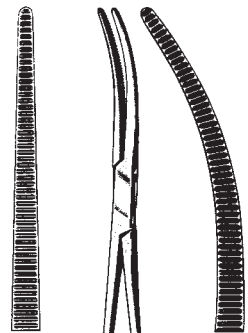

13448-22 22 cm, 8 3/4" 13449-22

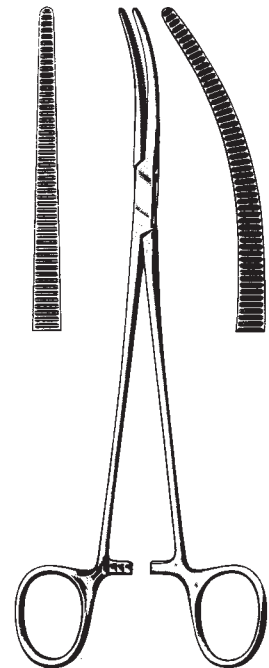

ROBERTS

Arterienklemmen  
 Hemostatic Forceps  
 Pinzas hemostáticas  
 Pinze emostatiche



CRAFOORD  
 13453-18 18 cm, 7"  
 13453-24 24 cm, 9 1/2"

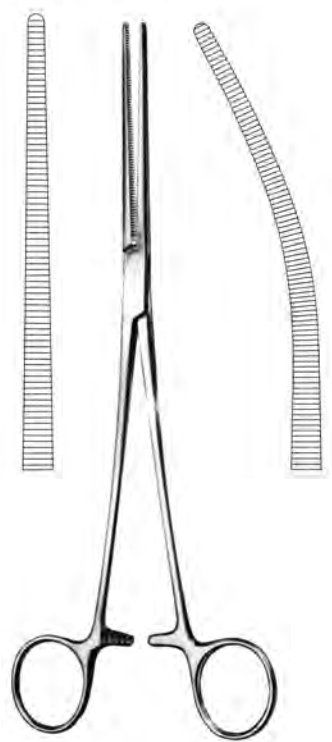

SAROT  
 13450-24 24 cm, 9 1/2" 13451-24



ZENKER  
 29,5 cm, 11 1/2"

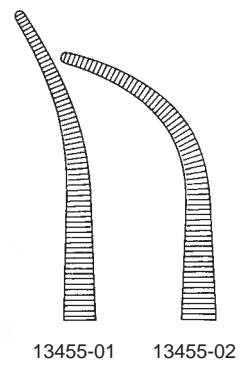

13455-01 13455-02

Arterienklemmen  
 Hemostatic Forceps  
 Pinzas hemostáticas  
 Pinze emostatiche

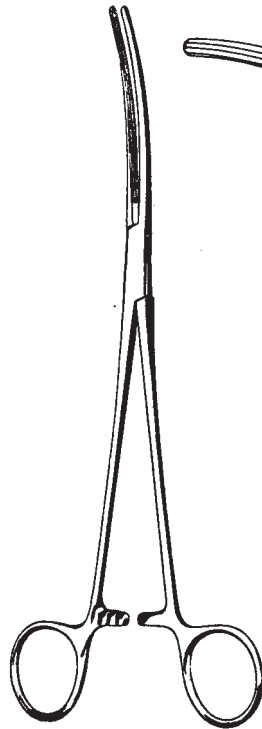

CRAFOORD-SELLORS  
 24 cm, 9 1/2"

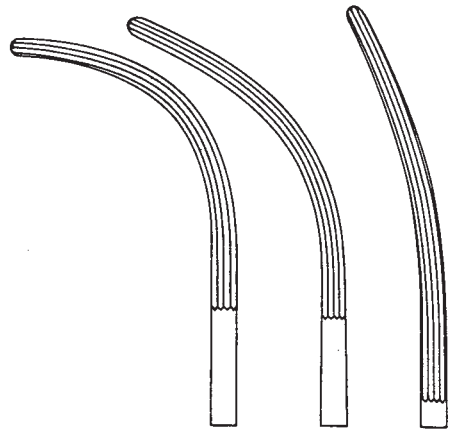

13456-01    13456-02    13456-03



LAWRENCE  
 13457-28 28 cm, 11"



MEEKER  
 13459-18 18 cm, 7"  
 13459-28 28 cm, 11"

Arterienklemmen  
 Hemostatic Forceps  
 Pinzas hemostáticas  
 Pinze emostatiche

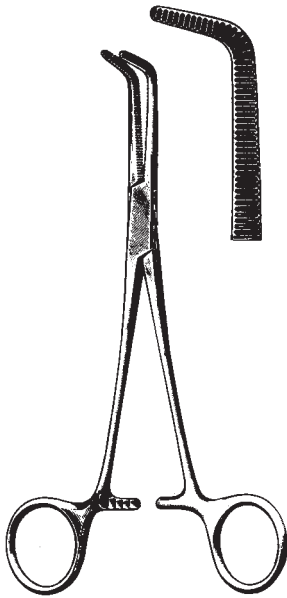

MIXTER  
 13471-14 14 cm, 5 1/2"  
 13471-16 16 cm, 6 1/4"  
 13471-18 18 cm, 7"  
 13471-23 23 cm, 9"

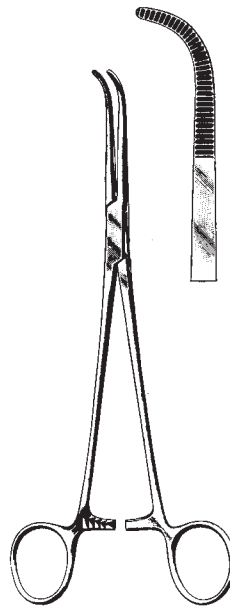

MIXTER  
 13473-22  
 22 cm, 8 3/4"



KANTROWITZ  
 13474-19 19 cm, 7 1/2"  
 13474-24 24 cm, 9 1/2"  
 13474-26 26 cm, 10 1/4"

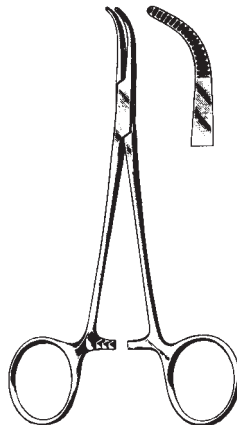

MIXTER BABY  
 13475-14  
 14 cm, 5 1/2"



MIXTER BABY  
 13475-18  
 18 cm, 7"

Arterienklemmen  
 Hemostatic Forceps  
 Pinzas hemostáticas  
 Pinze emostatiche

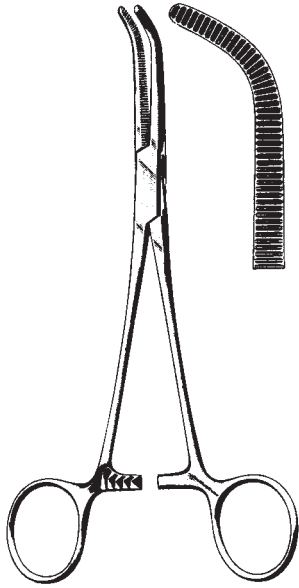

MIXTER-O'SHAUGHNESSY  
 13477-15 15,5 cm, 6"  
 13477-19 19,0 cm, 7 1/2"

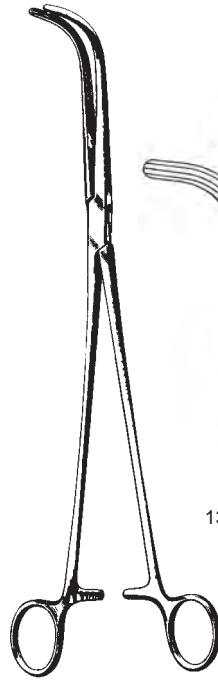

MIXTER

13479-22	13479-25	13479-28
22 cm	25 cm	28 cm
8 3/4"	10"	11"

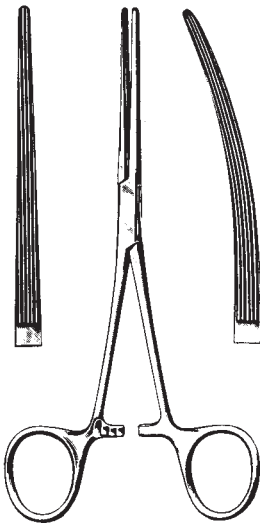

BAINBRIDGE  
 13480-15 15,0 cm, 6" 13481-15  
 13480-18 18,5 cm, 7 1/4" 13481-18

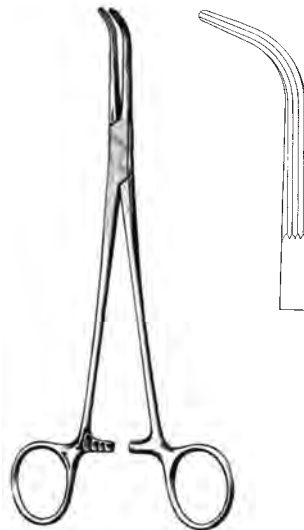

LAHEY  
 13491-19 19 cm, 7 1/2"

Arterienklemmen  
Hemostatic Forceps  
Pinzas hemostáticas  
Pinze emostatiche

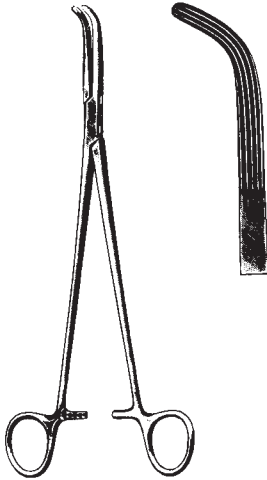

LAHEY  
13493-23 23 cm, 9"

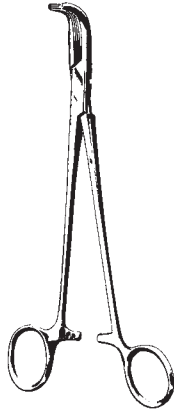

LOWER  
13495-18 18 cm, 7"

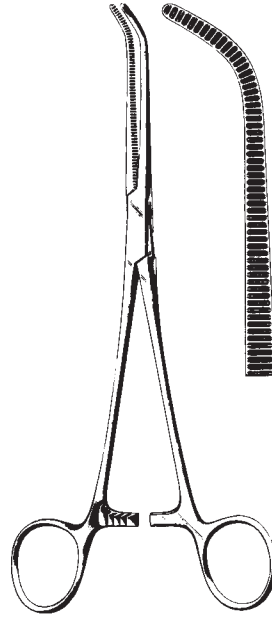

JOHNS-HOPKINS  
13497-20 20 cm, 8"

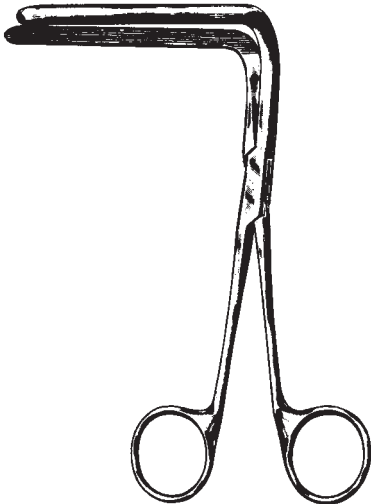

MIXTER  
13499-16  
16,5 cm, 6 1/2"

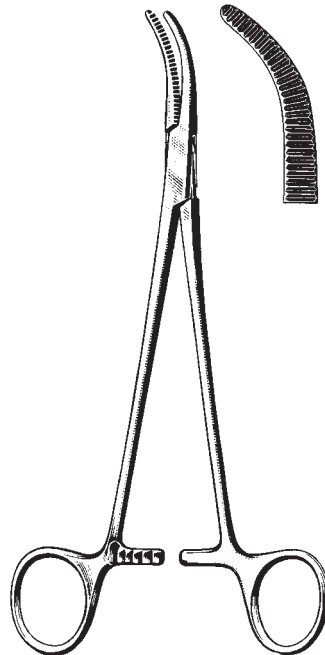

MOYNIHAN  
13501-23  
23 cm, 9"



Arterienklemmen  
 Hemostatic Forceps  
 Pinzas hemostáticas  
 Pinze emostatiche



DESJARDINS  
 13503-21 21 cm, 8 1/4"

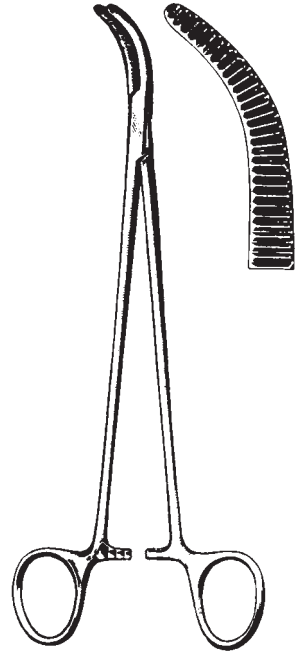

DESJARDINS  
 13505-21 21 cm, 8 1/4"

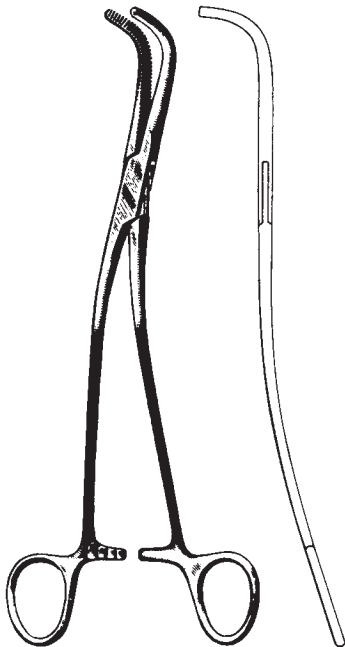

GRAY

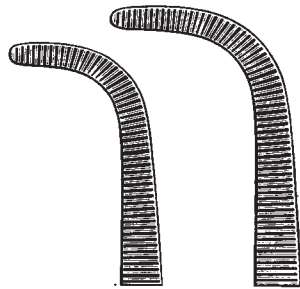

13507-22  
 22 cm  
 8 3/4"

13507-23  
 23 cm  
 9"

Arterienklemmen  
 Hemostatic Forceps  
 Pinzas hemostáticas  
 Pinze emostatiche

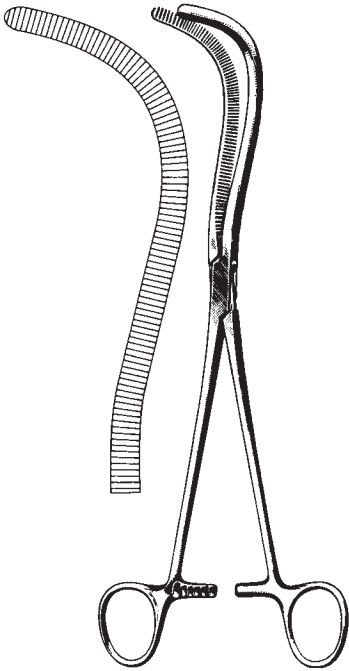

MAYO-GUYON  
 13513-23  
 23 cm, 9"

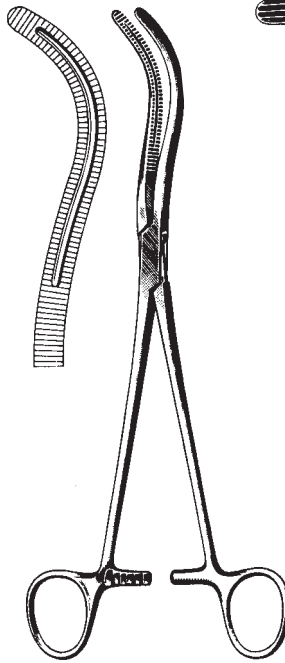

STILLE  
 13515-23  
 23 cm, 9"

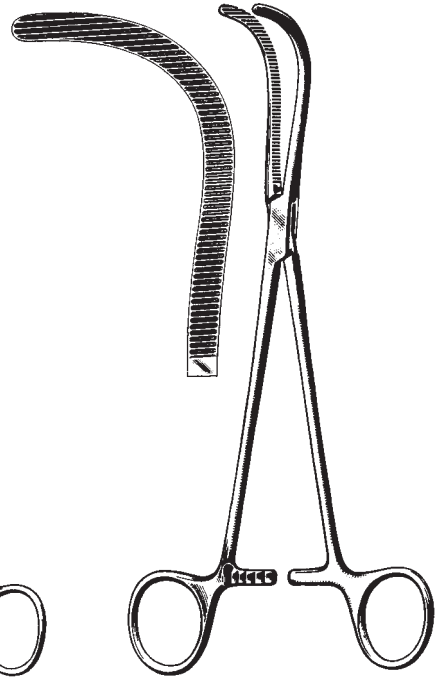

GUYON  
 13517-23  
 23 cm, 9"

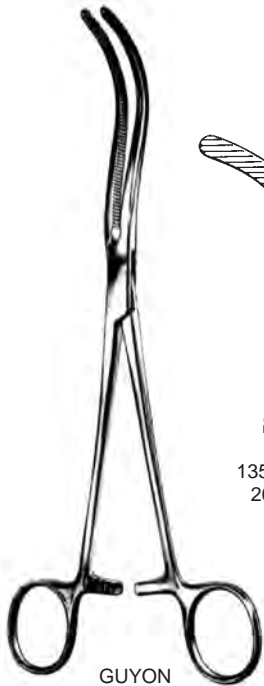

GUYON

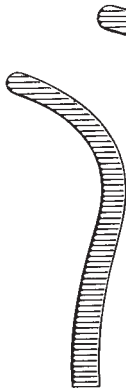

13519-20  
 20 cm  
 8"

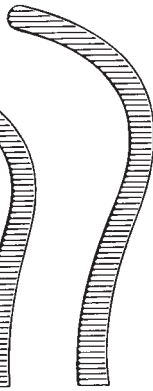

13519-22  
 22 cm  
 8 3/4"

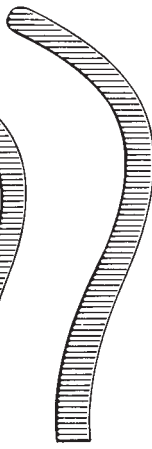

13519-24  
 24 cm  
 9 1/2"



GUYON



13520-24  
 24 cm  
 9 1/2"

13520-23  
 23 cm  
 9"

ATRAUMA

Hysterektomieklemmen  
 Hysterectomy Forceps  
 Pinzas para histerectomía  
 Pinze per isterectomia

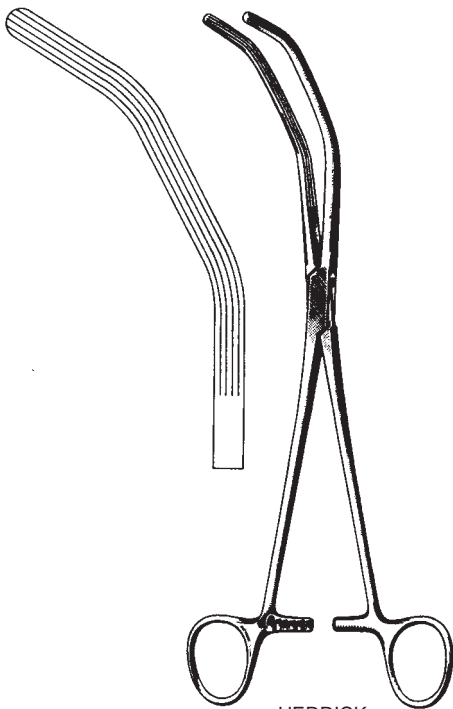

HERRICK  
 13523-23  
 23 cm, 9"

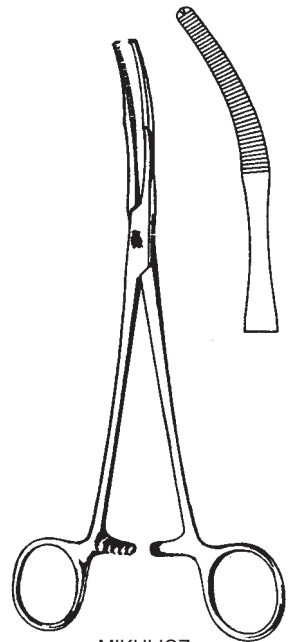

MIKULICZ  
 13551-14 14 cm, 5 1/2" BABY  
 13551-18 18 cm, 7"  
 13551-20 20 cm, 8"

Peritoneum-Klemme  
 Peritoneum Forceps  
 Pinzas para peritoneo  
 Pinze peritoneali

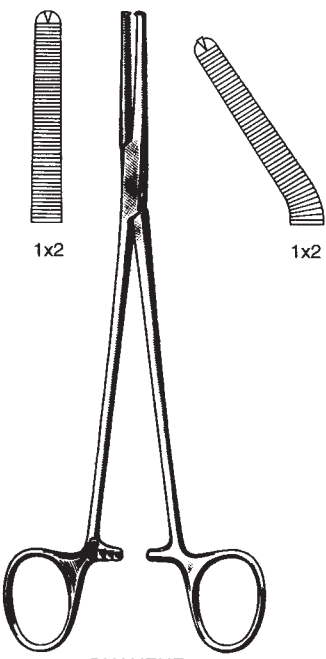

PHANEUF  
 13554-21 21 cm, 8 1/4" 13555-21



MIKULICZ  
 13556-24 24 cm, 9 1/2"

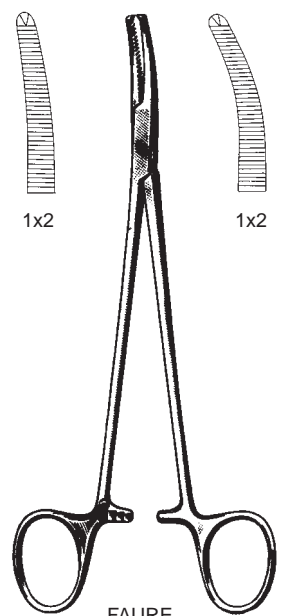

FAURE  
 13561-20 20 cm, 8" 13563-20

Hysterektomieklemmen  
Hysterectomy Forceps  
Pinzas para histerectomía  
Pinze per isterectomia



WERTHEIM  
13570-23  
23,5 cm, 9 1/4"

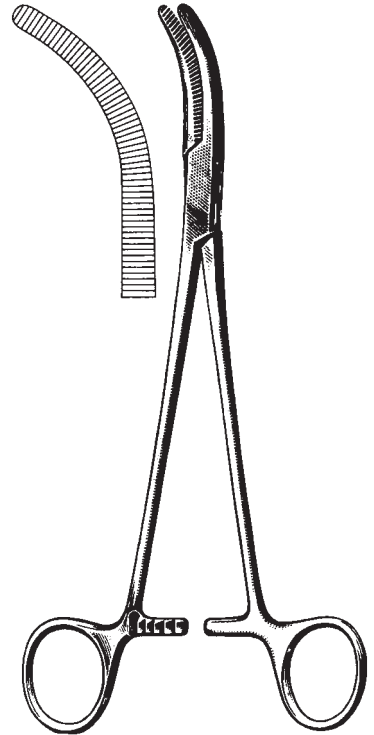

WERTHEIM  
13571-25  
25 cm, 10"



1x2

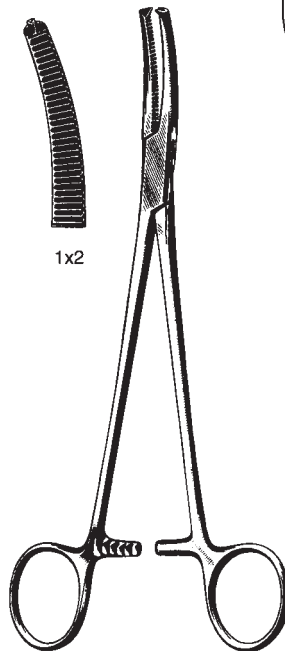

WERTHEIM  
13573-22 22 cm, 8 3/4"

Hysterektomieklemmen  
Hysterectomy Forceps  
Pinzas para histerectomía  
Pinze per isterectomia



SEGOND-LANDAU  
13574-24  
24 cm, 9 1/2"



SEGOND  
13575-24  
24 cm, 9 1/2"

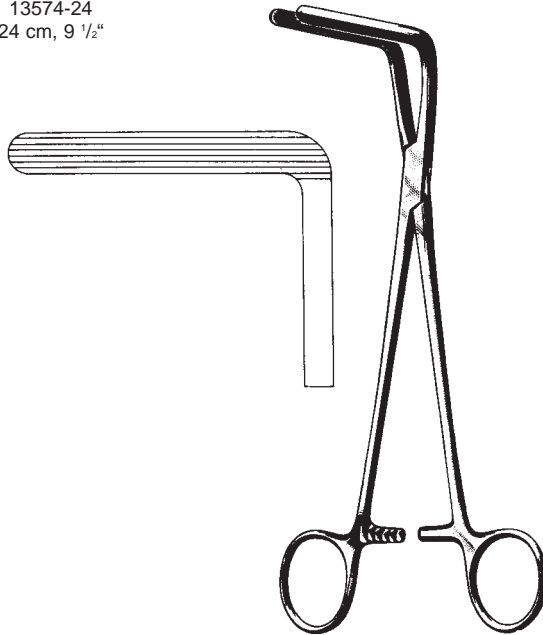

WERTHEIM-CULLEN  
13579-21 21,5 cm, 8 1/2"

Hysterektomieklemmen  
 Hysterectomy Forceps  
 Pinzas para histerectomía  
 Pinze per isterectomia



13580-80  
 80 mm, 3"  
 Maul/Morso/Boca



13580-60  
 60 mm, 2 1/4"  
 Maul/Morso/Boca



23 cm, 9"



13591-20



13593-20



HEANEY  
 20 cm, 8"

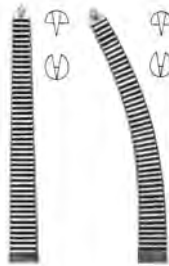

HOLZBACH  
 13598-24 24 cm, 9 1/2" 13599-24

Hysterektomieklemmen  
 Hysterectomy Forceps  
 Pinzas para histerectomía  
 Pinze per isterectomia



ATRAUMA

ROGERS  
 13595-10 - 13597-40

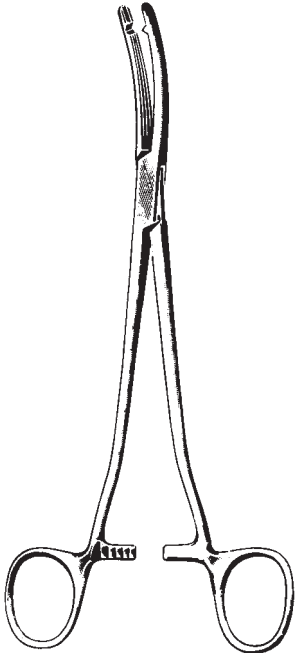
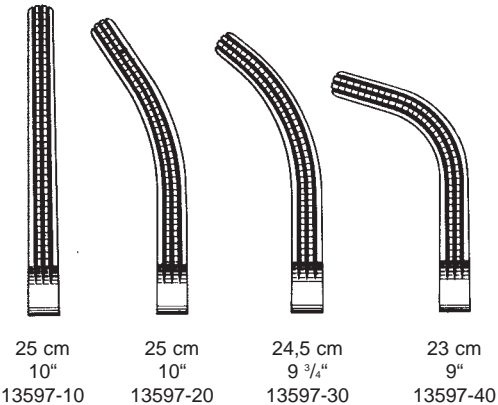
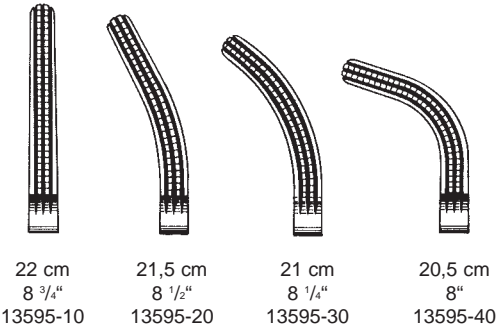

HEANY-BALLENTINE  
 13600-20 - 13601-20  
 20 cm, 8"

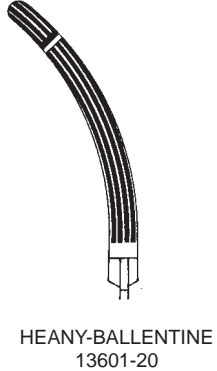

Hysterektomieklemmen  
Hysterectomy Forceps  
Pinzas para histerectomía  
Pinze per isterectomia



WERTHEIM  
13605-26  
25,5 cm, 10"



Schlauchklemmen  
 Tubing Clamps  
 Pinzas cierra-tubos  
 Pinze serratubi



KLINIKUM BERLIN  
 13702-14  
 14,5 cm, 5 3/4"



13710-15  
 15 cm, 6"



13710-18  
 18 cm, 7"



13710-20  
 20 cm, 8"



PRESBYTERIAN  
 13704-16 16 cm, 6 1/4"  
 13704-18 18 cm, 7"

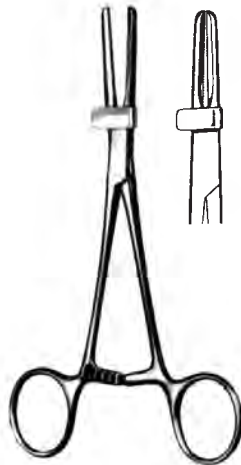

13712-15  
 15 cm, 6"



13712-18  
 18 cm, 7"

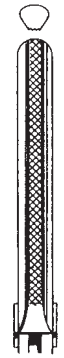

13712-20  
 20 cm, 8"

Schlauchklemme  
Tubing clamps  
Pinzas cierra-tubos  
Pinze serratubi a rulli

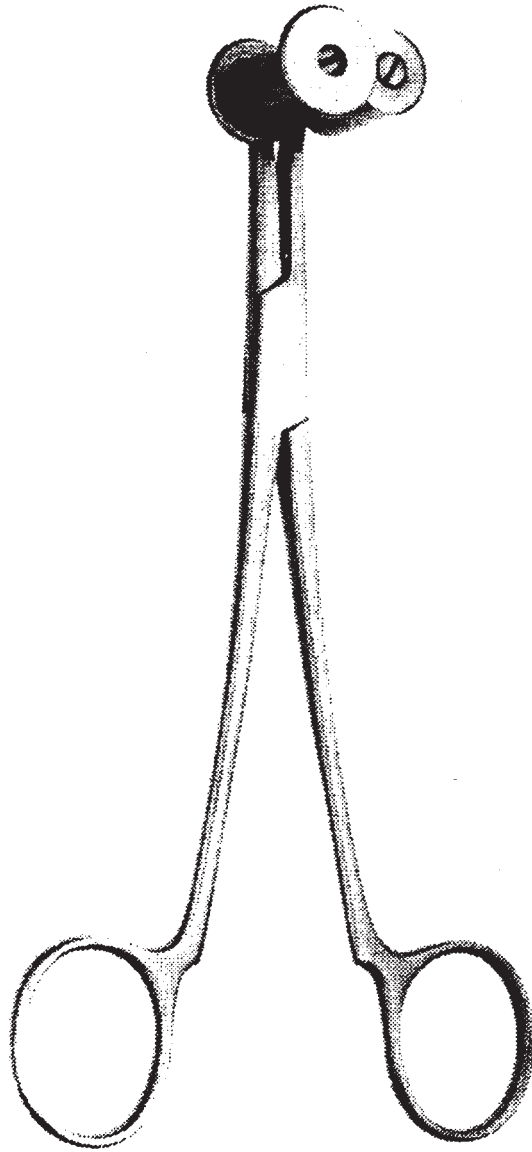

BÜLOW-GUNAR-HEY  
13720-18 18 cm, 7"

Tuchklemmen  
 Towel Forceps  
 Pinzas de campos  
 Pinze fissateli



SCHAEDEL  
 15101-09  
 9 cm, 3 1/2"



JONES  
 15103-07  
 7 cm, 2 3/4"  
 15103-09  
 9 cm, 3 1/2"

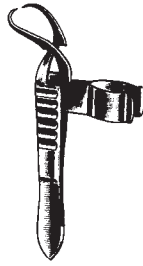

JONES-CLIP  
 15105-09  
 9 cm, 3 1/2"

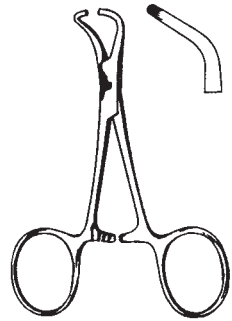

TOHUKU  
 15107-10 10 cm, 4"  
 15107-13 13 cm, 5 1/8"

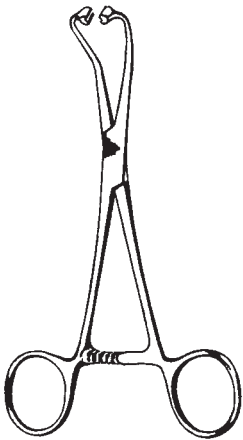

PEERS  
 15108-14  
 14,5 cm, 5 3/4"

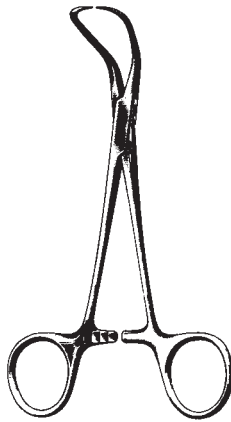

BACKHAUS  
 15111-09 9 cm, 3 1/2"  
 15111-11 11 cm, 4 3/8"  
 15111-13 13 cm, 5 1/8"  
 15111-15 15 cm, 6"



BACKHAUS-CLIP  
 15115-11  
 11 cm, 4 3/8"

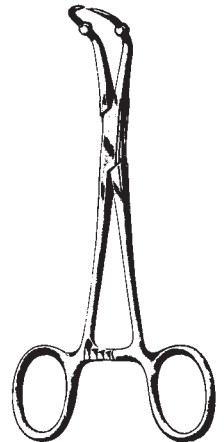

ROEDER  
 15117-13  
 13 cm, 5 1/8"

Tuchklemmen  
Towel Forceps  
Pinzas de campos  
Pinze fissateli

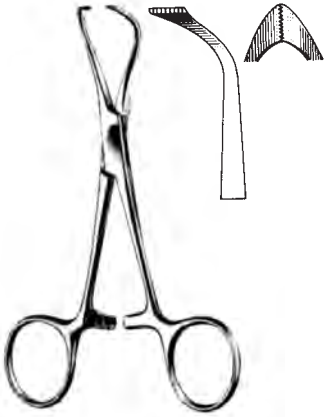

LORNA  
15121-11 11 cm, 4  $\frac{3}{8}$ "  
15121-13 13 cm, 5  $\frac{1}{8}$ "



BALL AND SOCKET  
15123-11 11 cm, 4  $\frac{3}{8}$ "  
15123-13 13 cm, 5  $\frac{1}{8}$ "



15125-14  
14,5 cm, 5  $\frac{3}{4}$ "

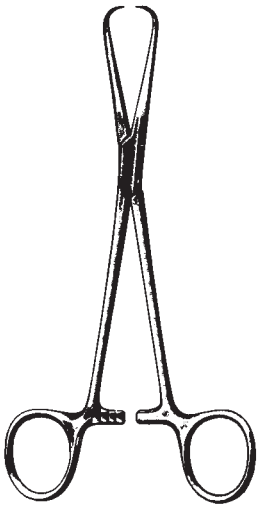

BERNHARD  
15140-16  
16,5 cm, 6  $\frac{1}{2}$ "

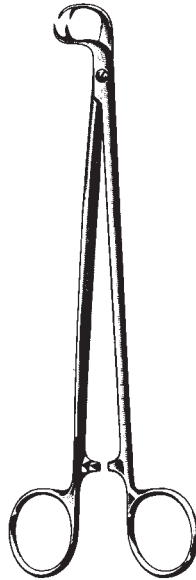

MOYNIHAN  
15150-19  
19 cm, 7  $\frac{1}{2}$ "



DOYEN  
15161-18  
18 cm, 7"

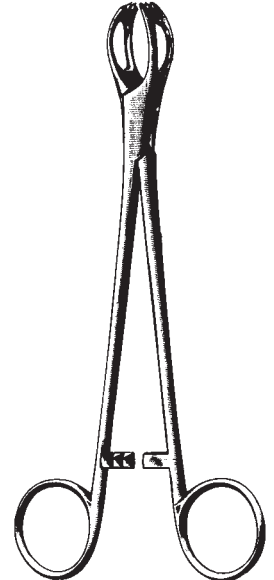

LANE  
15164-15 15 cm, 6"  
15164-20 20 cm, 8"

Tupferzangen  
 Dressing Forceps  
 Pinzas porta-esponjas  
 Pinze per medicatura

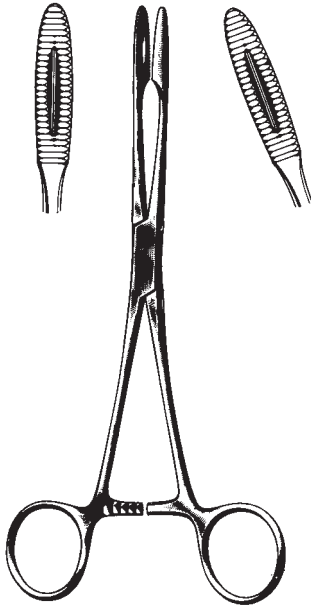

GROSS-MAIER  
 17110-20 20 cm, 8" 17111-20  
 17110-25 25 cm, 10" 17111-25

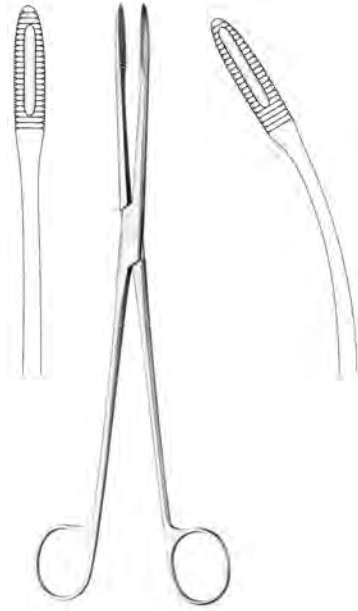

GROSS-MAIER  
 17112-20 20 cm, 8" 17113-20  
 17112-25 25 cm, 10" 17113-25

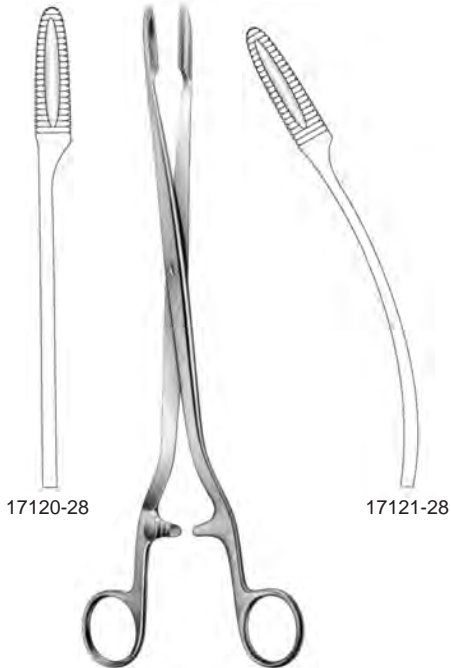

17120-28

17121-28

SIMS-MAIER  
 28 cm, 11"



DUPLAY KORNZANGE  
 17131-21 21 cm, 8 1/4"

Tupferzangen  
Dressing Forceps  
Pinzas porta-esponjas  
Pinze per medicatura



KORNZANGE  
17133-17 17 cm, 6 <sup>3</sup>/<sub>4</sub>"

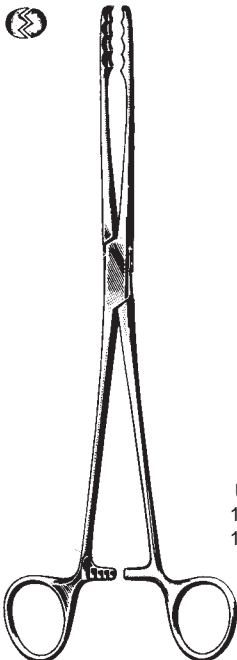

ULRICH  
17160-22  
17160-25



22 cm, 8 <sup>3</sup>/<sub>4</sub>"  
25 cm, 10"

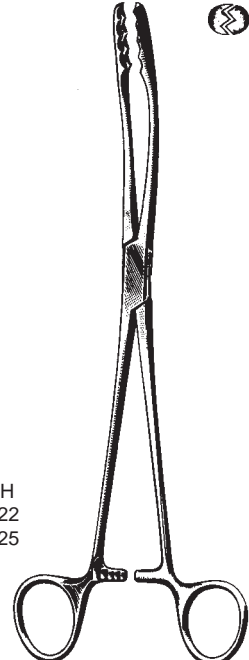

ULRICH  
17161-22  
17161-25

Tupferzange  
 Sponge Holding Forceps  
 Pinzas porta esponjas  
 Pinze ad anelli per tamponi e spugne

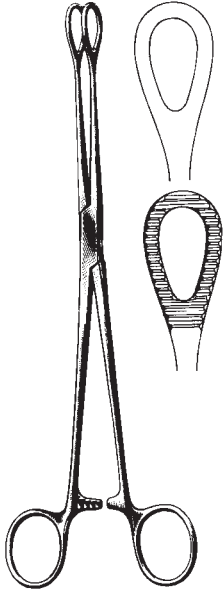

FOERSTER

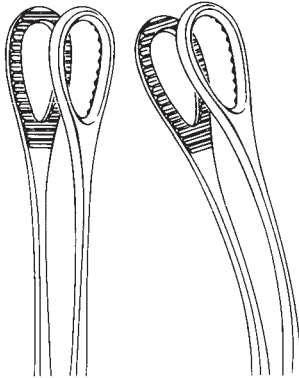

17170-18  
 17170-20  
 17170-25

17171-18 18 cm, 7"  
 17171-20 20 cm, 8"  
 17171-25 25 cm, 10"

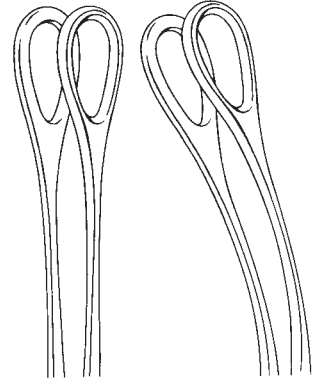

17172-18  
 17172-25

17173-18  
 17173-25

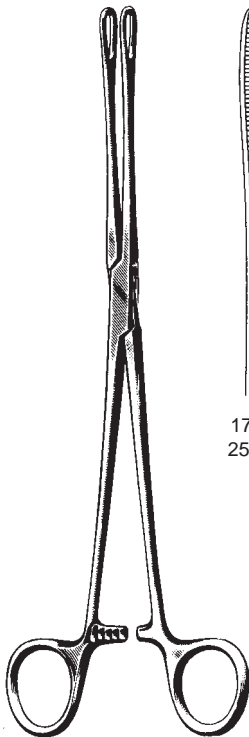

FOERSTER

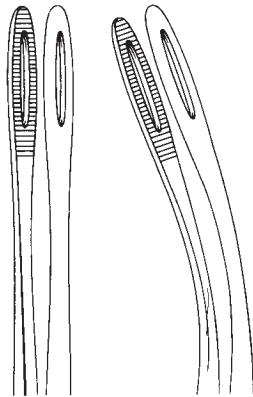

17174-25  
 25 cm, 10"

17175-25  
 25 cm, 10"

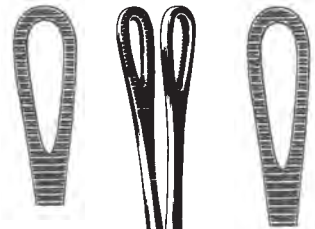

17180-18  
 18 cm, 7"

17180-25  
 25 cm, 10"

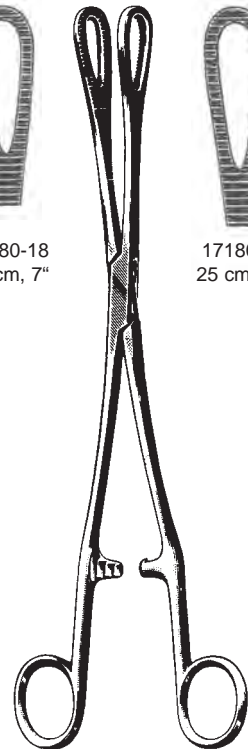

RAMPLEY

Tupferzangen  
 Dressing Forceps  
 Pinzas porta-esponjas  
 Pinze per tamponi

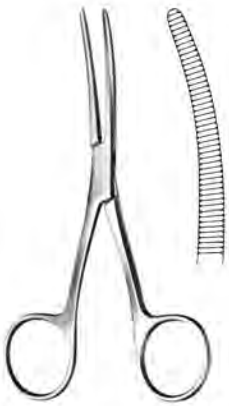

BRYANT  
 17207-13  
 13 cm, 5 1/8"



LISTER (Sinus)  
 17210-13 13 cm, 5 1/8"  
 17210-16 16 cm, 6 1/4"  
 17210-18 18 cm, 7"

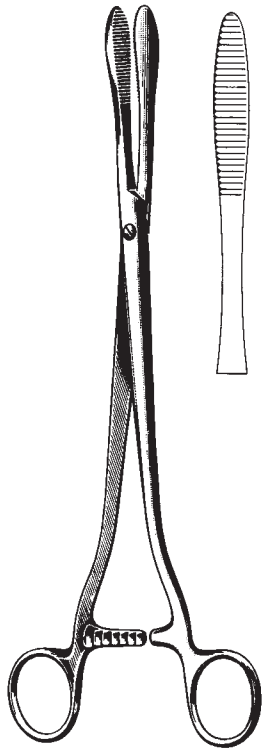

COLLIN  
 17220-25 25 cm, 10"



PELKMANN  
 17226-25 25 cm, 10"



CHERON  
 17229-25 25 cm, 10"



Tamponzangen  
Dressing Forceps  
Pinzas para tapones  
Pinze per tamponi

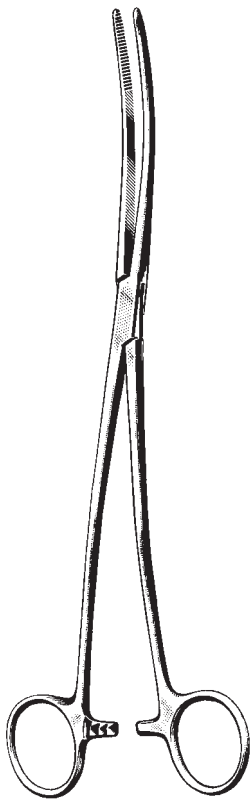

— BOZEMANN —  
17230-26 17231-26  
26 cm, 10 1/4"

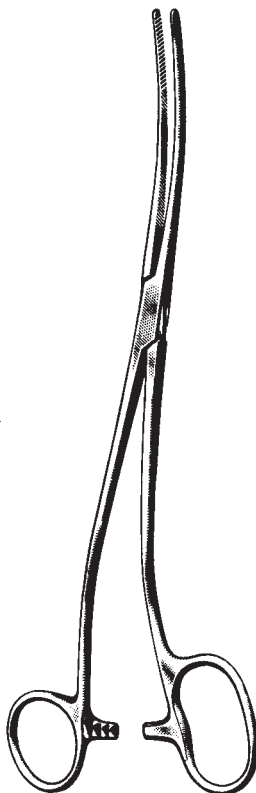

BOZEMANN-DOUGLAS  
17233-26  
26 cm, 10 1/4"

Wundhaken  
Retractors  
Separadores  
Divaricatori

\* Satz, set, juego, serie

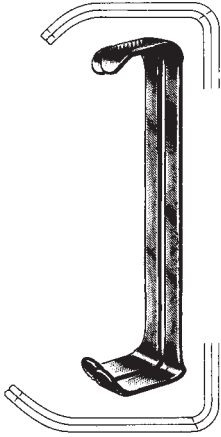

\* FARABEU  
19102-12  
12 cm, 4 3/4"

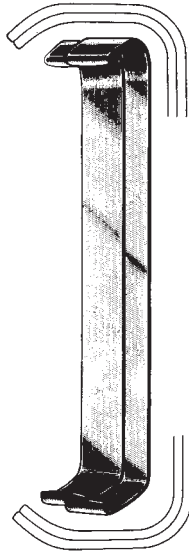

\* FARABEU  
19102-15  
15 cm, 6"



COLLIN  
19104-15  
15 cm, 6"

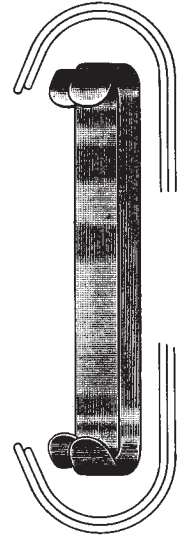

\* PARKER  
19110-13  
13,5 cm, 5 1/4"

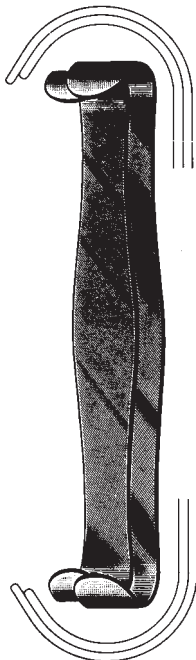

\* PARKER  
19110-18 18 cm, 7"

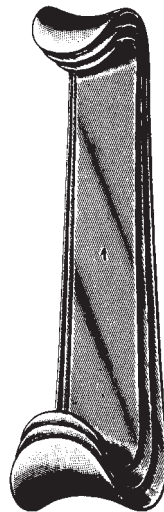

\* ROUX  
19120-00

Fig. 1 = 24x20 mm  
Fig. 2 = 29x26 mm  
Fig. 3 = 35x29 mm

Fig. 1 = 30x28 mm  
Fig. 2 = 36x36 mm  
Fig. 3 = 38x43 mm

19120-14 Fig. 1 14 cm, 5 1/2"  
19120-15 Fig. 2 15 cm, 6"  
19120-17 Fig. 3 17 cm, 6 3/4"

Wundhaken  
 Retractors  
 Separadores  
 Divaricatori



ROUX BABY  
 19122-13  
 13 cm, 5 1/8"



LUER  
 19123-11  
 11 cm, 4 3/8"

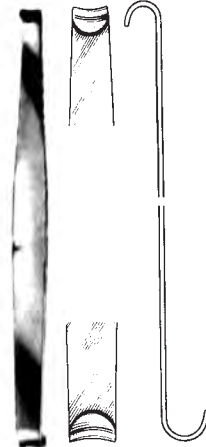

ROUX mini  
 19124-15  
 14 cm, 5 1/2"



RAGNELL  
 19125-14  
 14 cm, 5 1/2"



ROSE  
 19126-13  
 13 cm, 5 1/8"



CRILE  
 19127-11  
 11,5 cm, 4 1/2"

Wundhaken  
Retractors  
Separadores  
Divaricatori

Fig. 2 = 25x24 mm  
Fig. 1 = 21x24 mm

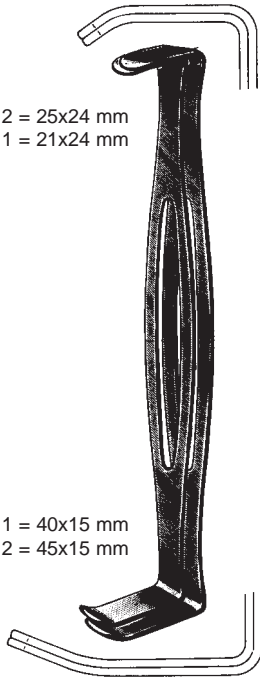

Fig. 1 = 40x15 mm  
Fig. 2 = 45x15 mm

\* US ARMY / Parker-Langenbeck  
19131-21 21 cm, 8 1/4"



MAYO-COLLINS  
19132-15  
15 cm, 6"

Fig. 2 = 47x13 mm  
Fig. 1 = 42x13 mm

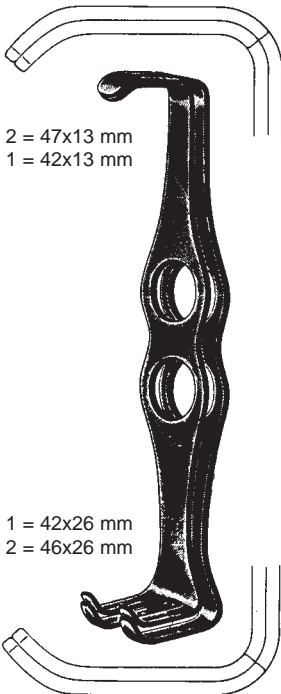

Fig. 1 = 42x26 mm  
Fig. 2 = 46x26 mm

\* MATHIEU  
19134-20 20 cm, 8"

37x40 mm



30 x 31 mm

GOELET  
19135-19 19 cm, 7 1/2"

52x33 mm

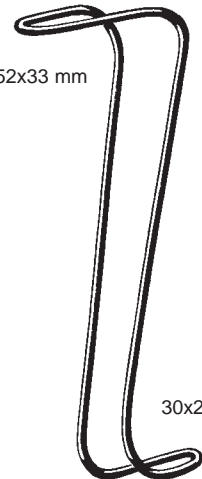

30x21 mm

COLLIN-HARTMANN  
19137-16 16 cm, 6 1/4"

Wundhaken  
Retractors  
Separadores  
Divaricatori

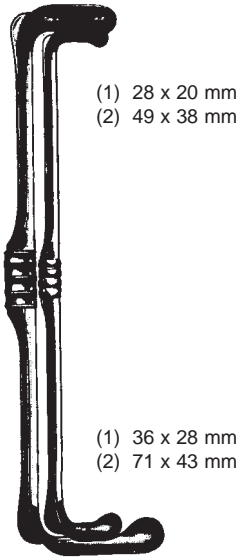

(1) 28 x 20 mm  
(2) 49 x 38 mm

(1) 36 x 28 mm  
(2) 71 x 43 mm

RICHARDSON-EASTMAN

(Set) 19140-00

(1) 19140-01 26 cm, 10 1/4"

(2) 19140-02 28 cm, 11"

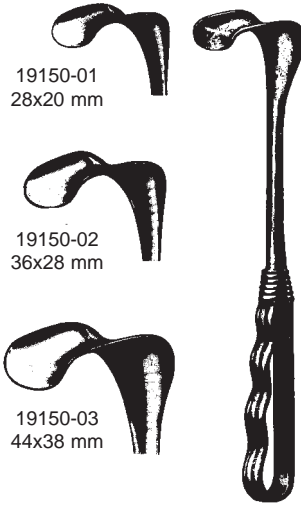

19150-01  
28x20 mm

19150-02  
36x28 mm

19150-03  
44x38 mm

RICHARDSON

24 cm, 9 1/2"



47x21 mm

RICHARDSON

19150-04

24 cm, 9 1/2"

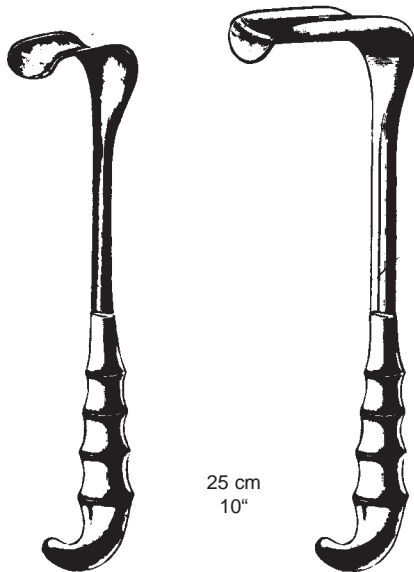

25 cm  
10"

RICHARDSON GRIP

19152-25 20x25 mm

19152-31 25x31 mm

19152-38 38x38 mm

19152-51 19x51 mm

19152-64 41x64 mm

KELLY GRIP

19158-51 38x51 mm

19158-64 51x64 mm

19158-76 64x76 mm

19158-82 70x82 mm



19159-50  
50x40 mm

19159-64  
64x54 mm

19159-70  
70x65 mm

19159-90  
90x76 mm

KELLY

26 cm, 10 1/4"

Wundhaken, Bauch- und Darmspatel  
 Retractors, abdominal and intestinal spatula  
 Separadores, espátula intestinal y abdominal  
 Divaricatori, spatole addominali e intestinali

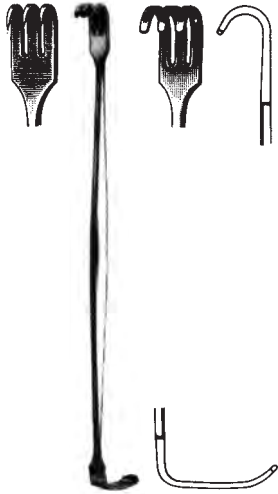

SENN-MILLER

19160-17 17 cm, 6 3/4" 19161-17

biegsam, malleable, maleable, malleabili



RIBBON

19168-06 6x200 mm  
 19168-08 8x200 mm  
 19168-10 10x200 mm  
 19168-12 12x200 mm  
 19168-17 17x200 mm  
 19168-20 20x200 mm  
 19168-25 25x200 mm  
 19169-25 25x250 mm



RIBBON

19170-20 20x330 mm  
 19170-25 25x330 mm  
 19170-32 32x330 mm  
 19170-40 40x330 mm  
 19170-45 45x330 mm  
 19170-50 50x330 mm  
 19170-65 65x330 mm  
 19170-76 76x330 mm

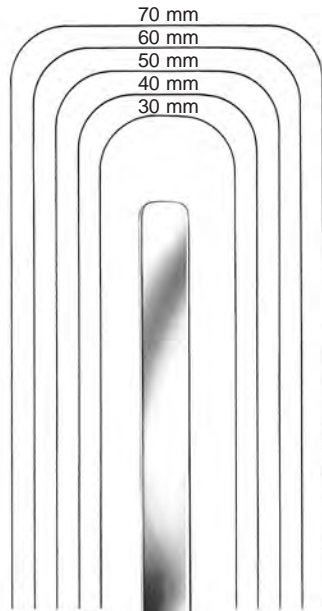

biegsam  
 malleable  
 maleable  
 malleabili

41 cm, 16"

19171-30 30 mm  
 19171-40 40 mm  
 19171-50 50 mm  
 19171-60 60 mm  
 19171-70 70 mm

Bauch- und Darmspatel  
 Abdominal and intestinal spatulas  
 Separadores, espátula intestinal y abdominal  
 Divaricatori, spatole addominali e intestinali



KÖRTE  
 19172-30  
 30 cm, 12"



KADER  
 28 cm, 11"

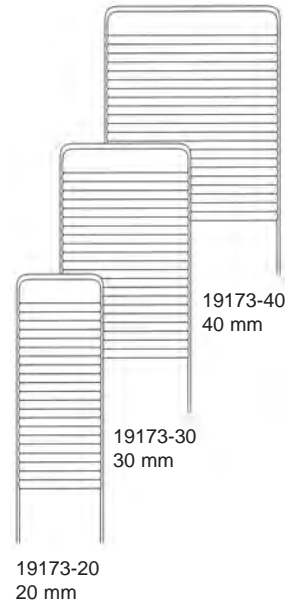

19173-20  
 20 mm

19173-30  
 30 mm

19173-40  
 40 mm



biegsam  
 malleable  
 malleable  
 malleabili

HABERER  
 19174-17 17/25x200 mm  
 19174-25 25/30x280 mm  
 19174-37 37/45x300 mm  
 19174-40 40/50x300 mm



60 mm

45 mm

REVERDIN  
 19175-28  
 28 cm, 11"

Bauch- und Darmspatel  
Abdominal and intestinal spatula  
Separadores, espátula intestinal y abdominal  
Divaricatori, spatole addominali e intestinali

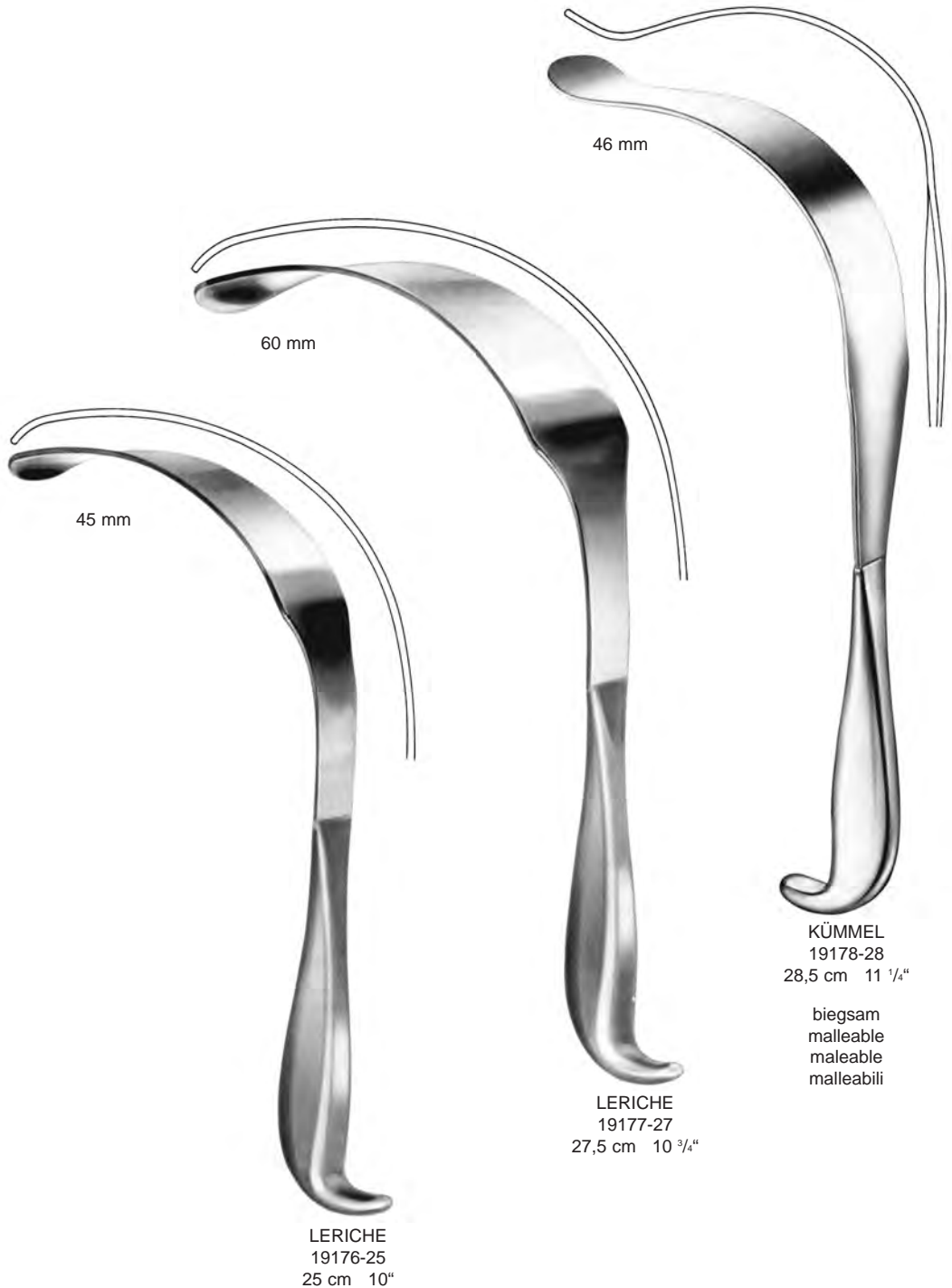



Bauchspatel  
Abdominal Spatulas  
Espátula abdominal  
Spatola addominale



KÜMMEL  
19179-28  
31 cm 12 1/4"

Wundhaken  
Retractors  
Separadores  
Divaricatori



19 mm

DEAVER  
19180-19  
19 cm, 7 1/2"



22 mm

DEAVER  
19181-22  
21,5 cm, 8 1/2"



25 mm

DEAVER  
19181-25  
23 cm, 9"



25 mm

DEAVER  
19183-25  
30 cm, 11 3/4"



25 mm

DEAVER  
19185-25  
33 cm, 13"



25 mm

DEAVER  
19187-25  
36 cm, 14"

Wundhaken  
Retractors  
Separadores  
Divaricatori



38 mm

DEAVER  
19187-38 38x300 mm  
30 cm, 11 3/4"



50 mm

DEAVER  
19187-50 50x300 mm  
31 cm 12 1/4"



75 mm

DEAVER  
19187-75 75x300 mm  
32 cm, 12 3/4"



DEAVER GRIP  
19189-25 25x310 mm  
19189-38 38x310 mm  
19189-50 50x310 mm  
19189-75 75x310 mm  
31 cm 12 1/4"

Wundhaken  
Retractors  
Separadores  
Divaricatori

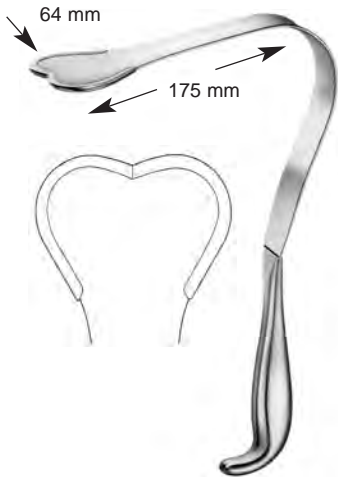

HARRINGTON-PEMBERTON  
19190-64  
29,5 cm 11 3/4"



HARRINGTON  
19191-25 25x230 mm  
19191-40 40x320 mm  
19191-62 62x320 mm



TUFFIER  
19192-23

Wundhaken  
Retractors  
Separadores  
Divaricatori

rechts  
right  
a la derecha  
a destra  
(45 mm x 48 mm)



COOLEY  
19195-01  
21,5 cm, 8 1/2"

rechts, gerieft  
right serrated  
a la derecha, estriado  
a destra, zigrinato  
(45 mm x 48 mm)



COOLEY  
19195-02  
21,5 cm, 8 1/2"

links  
left  
a la izquierda  
a sinistra  
(24 mm x 48 mm)



COOLEY  
19195-03  
23 cm, 9"

Hauthäkchen  
 Nerve and wound hooks  
 Ganchos y ganchitos para nervios  
 Uncini per nervi e divaricatori fini



GRAEFE  
 19210-12  
 scharf  
 sharp  
 agudo  
 acuto



GRAEFE  
 19211-12  
 stumpf  
 blunt  
 romo  
 smusso



12 cm, 4 3/4"



GUTHRIE  
 19212-01



GUTHRIE  
 19212-02



scharf  
 sharp  
 agudo  
 acuto  
 A  
 stumpf  
 blunt  
 romo  
 smusso  
 B

FRAZIER

- |   |          |           |
|---|----------|-----------|
| A | 19214-13 | 13 cm, 5" |
| A | 19214-18 | 18 cm, 7" |
| B | 19215-13 | 13 cm, 5" |
| B | 19215-18 | 18 cm, 7" |



LAHEY  
 12 cm, 4 3/4"



19215-01



19215-02



19215-03



JOSEPH  
 16 cm, 6 1/4"



19216-01



19216-02  
 2 mm



19216-05  
 5 mm



19216-07  
 7 mm



19216-10  
 10 mm



KLEINERT-KUTZ  
 13 cm, 5 1/8"



19217-03



19217-05



19217-07

Hauthäkchen  
 Nerve and wound hooks  
 Ganchos y ganchitos para nervios  
 Uncini per nervi e divaricatori fini

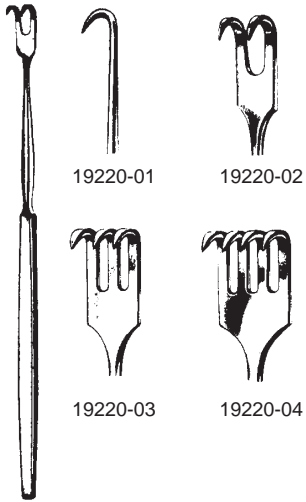

19220-01

19220-02

19220-03

19220-04

Reda  
 16 cm, 6 1/4"

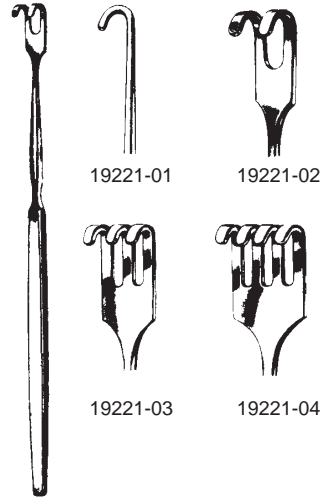

19221-01

19221-02

19221-03

19221-04

Reda  
 16 cm, 6 1/4"

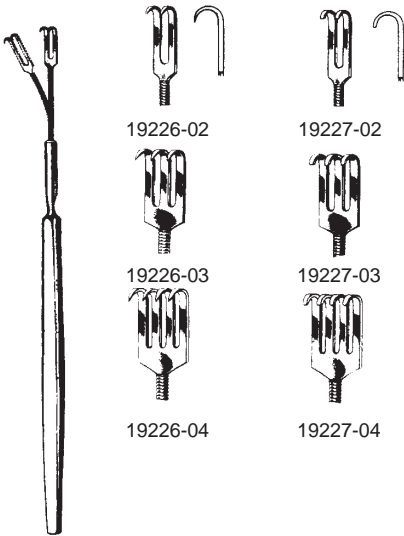

19226-02

19227-02

19226-03

19227-03

19226-04

19227-04

Reda, flexibel  
 16 cm, 6 1/4"



19229-02

19229-03

KLAPP  
 17,5 cm, 6.9"

Wundhaken  
Retractors  
Separadores  
Divaricatori

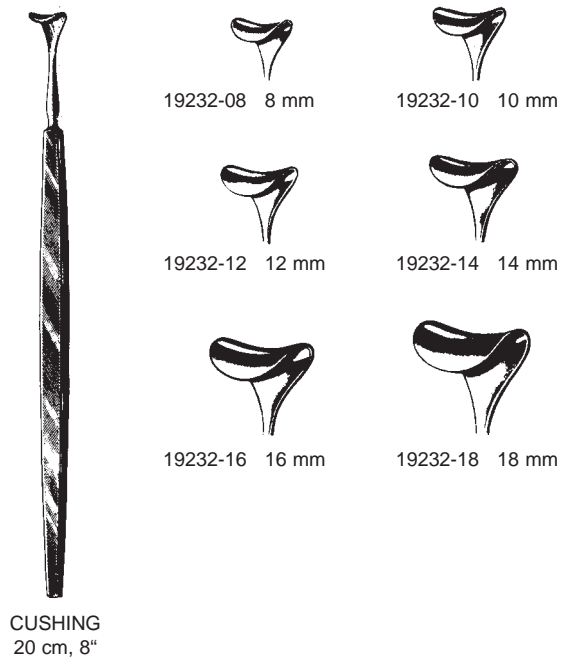
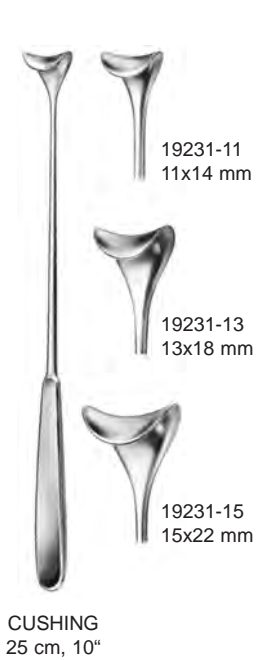
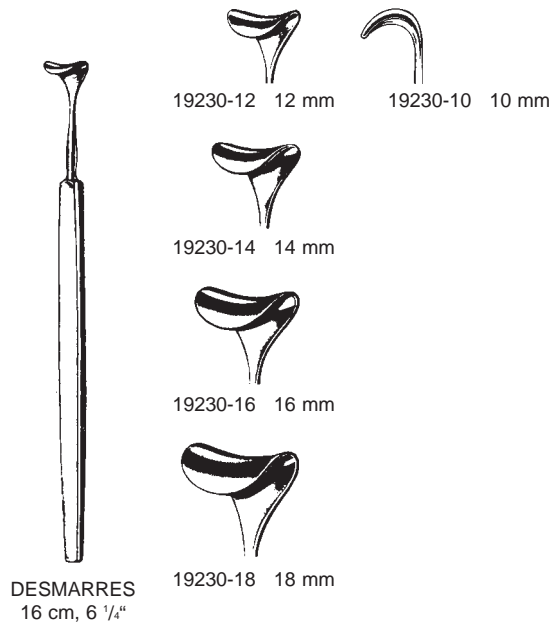



Wundhaken  
 Retractors  
 Separadores  
 Divaricatori



CUSHING  
 24 cm, 9 1/2"

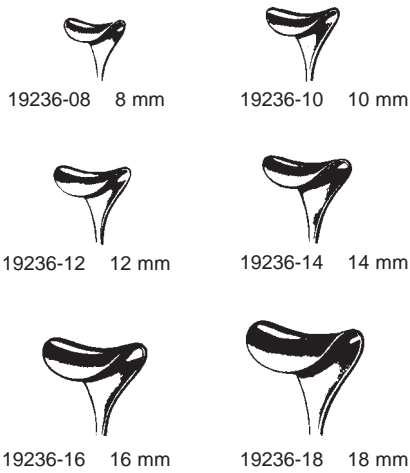

19236-08 8 mm

19236-10 10 mm

19236-12 12 mm

19236-14 14 mm

19236-16 16 mm

19236-18 18 mm



biegsam  
 malleable  
 maleable  
 malleabile

GIL-VERNET  
 19233-08 - 19233-23  
 24 cm, 9 1/2"



19233-08  
 8 mm

19233-11  
 11 mm

19233-15  
 15 mm



19233-17  
 17 mm

19233-20  
 20 mm

19233-23  
 23 mm

Wundhaken  
Retractors  
Separadores  
Divaricatori



CUSHING  
19234-20  
20 cm, 8"



CUSHING  
19235-21  
21,5 cm, 8 1/2"



KÖNIG  
18 cm, 7"



19236-01  
13x13 mm

19236-02  
12x16 mm



19240-10 10x6 mm

19240-20 20x6 mm

SENN-GREEN  
15 cm, 6"



LANGENBECK-GREEN  
16 cm, 6 1/4"



19250-16  
16x6 mm

19250-24  
24x6 mm



VOLKMAN  
11,5 cm, 4 1/2"



19270-02



19271-02



19270-03



19271-03



19270-04



19271-04



19270-06



19271-06

Wundhaken  
 Retractors  
 Separadores  
 Divaricatori



19280-01



19280-02



19280-03



19280-04



19280-06



scharf  
 sharp  
 agudo  
 acuto



19281-01



19281-02



19281-03



19281-04



19281-06

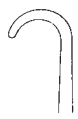

stumpf  
 blunt  
 romo  
 smusso



19282-02



19282-03



19282-04



19282-06



halbscharf  
 semi-sharp  
 medio romo  
 mezzo smusso



VOLKMANN  
 21,5 cm, 8 1/2"

Wundhaken  
Retractors  
Separadores  
Divaricatori



19296-01



19296-02



19296-03



19296-04



19296-06



19296-08



19297-01



19297-02



19297-03



19297-04



19297-06

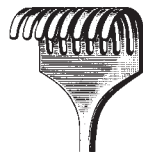

19297-08



KOCHER  
19296-01 - 19297-08  
22 cm, 8 3/4"

Wundhaken, Knochenhaken  
 Retractors, Bone Retractors  
 Separadores, Separadores oseos  
 Divaricatori, Divaricatori per ossa



23 mm

scharf  
 sharp  
 agudo  
 acuto

VOLKMANN  
 19298-01  
 22 cm 8 3/4"

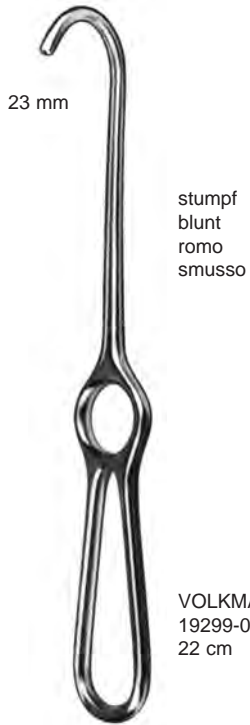

23 mm

stumpf  
 blunt  
 romo  
 smusso

VOLKMANN  
 19299-01  
 22 cm 8 3/4"

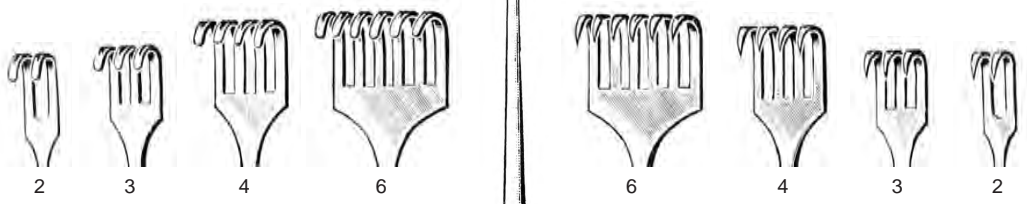

Zähne  
 teeth  
 dientes  
 denti

stumpf  
 blunt  
 romo  
 smusso

19301-02 8x 8 mm  
 19301-03 8x13 mm  
 19301-04 8x18 mm  
 19301-06 8x28 mm

scharf  
 sharp  
 agudo  
 acuto

19300-02 8x 8 mm  
 19300-03 8x13 mm  
 19300-04 8x18 mm  
 19300-06 8x28 mm

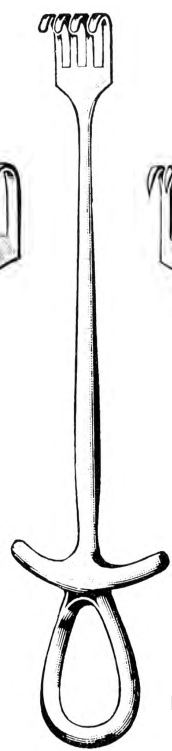

MURPHY  
 19,4 cm 7 5/8"

Wundhaken  
Retractors  
Separadores  
Divaricatori



MEYERDING  
18 cm, 7"



19302-01 18x7 mm



19302-04 7x4 mm



19302-02 16x5 mm



19302-05 10x3 mm



19302-03 7x4 mm



19302-06 10x4 mm



28x6 mm



LAHEY  
19304-19  
19 cm, 7 1/2"



12x14 mm



LITTLE  
19306-20  
20 cm, 8"



STRANDELL-STILLE  
17 cm 6 3/4"



19307-01



19307-02

Wundhaken  
Retractors  
Separadores  
Divaricatori

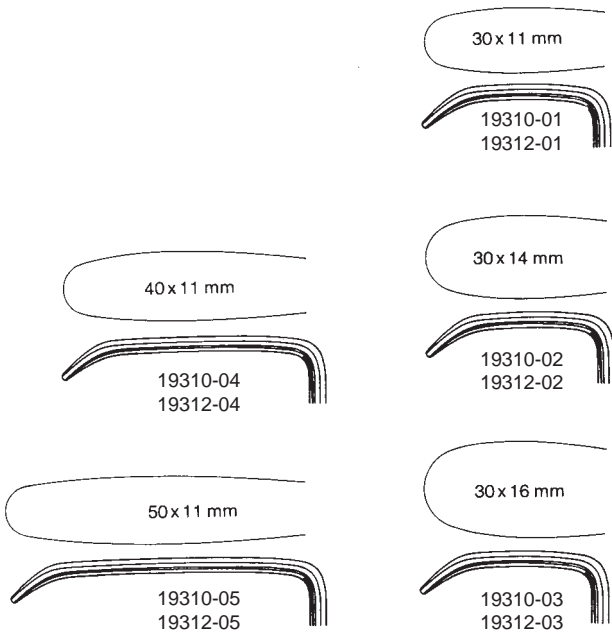

LANGENBECK  
19310-01 - 19310-05  
22 cm, 8 3/4"

LANGENBECK  
19312-01 - 19312-05  
21 cm, 8 1/4"

- 19314-07 35x 7 mm
- 19314-10 35x10 mm
- 19314-12 80x12 mm
- 19314-14 70x14 mm
- 19314-15 35x15 mm
- 19314-16 80x16 mm
- 19314-20 60x20 mm
- 19315-06 25x 6 mm
- 19330-40 40x12 mm
- 19330-55 55x11 mm

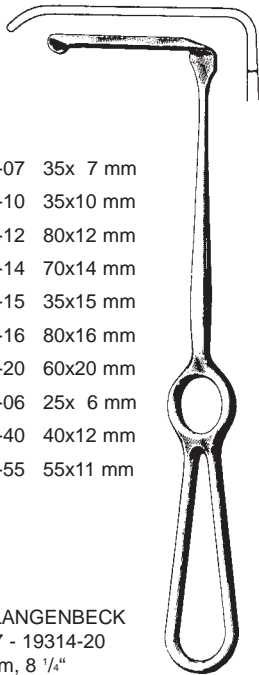

KOCHER-LANGENBECK  
19314-07 - 19314-20  
21 cm, 8 1/4"

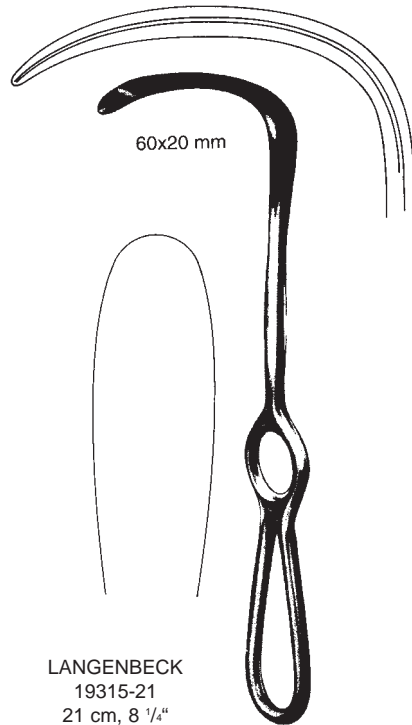

LANGENBECK  
19315-21  
21 cm, 8 1/4"



LANGENBECK  
19317-21  
21 cm, 8 1/4"

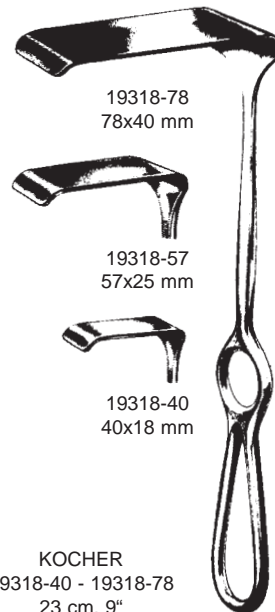

KOCHER  
19318-40 - 19318-78  
23 cm, 9"



Wundhaken  
 Retractors  
 Separadores  
 Divaricatori



19344-14  
 14x17 mm  
 21,5 cm, 8 1/2"



19344-20  
 20x22 mm  
 22 cm, 8 3/4"



19344-26  
 26x30 mm  
 23,5 cm, 9 1/4"



MIDDELDORF  
 19344-14 - 19344-26



KOCHER  
 19340-10 40x10 mm  
 19340-15 40x15 mm  
 19340-20 40x20 mm  
 22 cm, 8 3/4"

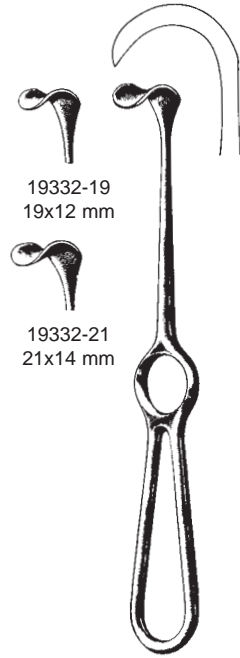

19332-19  
 19x12 mm  
 19332-21  
 21x14 mm  
 KOCHER  
 19332-19 - 19332-21  
 19 cm, 7 1/2"



MIDDELDORF  
 19345-01 45x45 mm  
 25,5 cm, 10"



19345-02  
 45x50 mm



19345-03  
 55x70 mm



GREEN  
 19348-22  
 22 cm, 8 3/4"

Wundhaken  
Retractors  
Separadores  
Divaricatori



35 x 8 mm

ZENKER  
19350-35  
25 cm, 10"



60 x 12 mm

ZENKER  
19350-60  
26 cm, 10 1/4"



75 x 12 mm

ZENKER  
19350-70  
27,5 cm, 10.8"

Wundhaken  
 Retractors  
 Separadores  
 Divaricatori

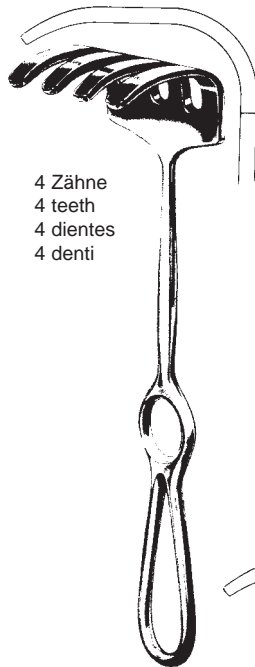

4 Zähne  
 4 teeth  
 4 dientes  
 4 denti

ISRAEL  
 19364-40 40X40 mm  
 25 cm, 10"

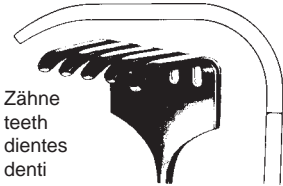

5 Zähne  
 5 teeth  
 5 dientes  
 5 denti

19364-50 45x50 mm

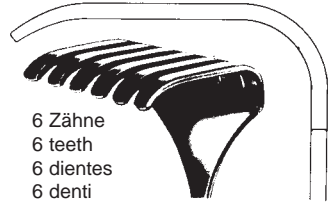

6 Zähne  
 6 teeth  
 6 dientes  
 6 denti

19364-60 50x60 mm

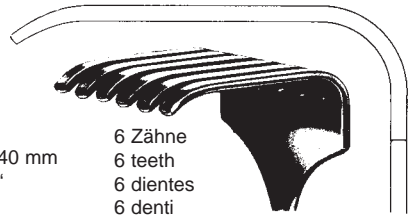

6 Zähne  
 6 teeth  
 6 dientes  
 6 denti

19364-70 70x70 mm

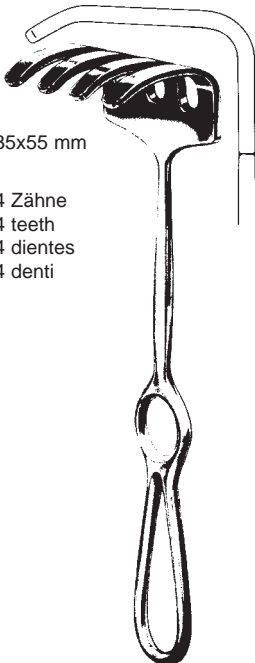

35x55 mm

4 Zähne  
 4 teeth  
 4 dientes  
 4 denti

OLLIER  
 19360-04 22,5 cm, 8.9"

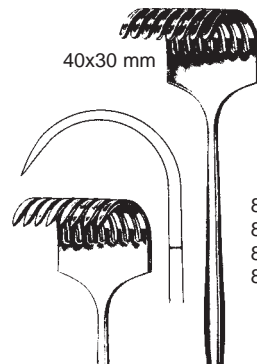

40x30 mm

8 Zähne  
 8 teeth  
 8 dientes  
 8 denti

spitz  
 sharp  
 agudo  
 acuto

stumpf  
 blunt  
 romo  
 smusso

KOERTE  
 19366-08 23,5 cm, 9 1/4" 19367-08

Wundhaken  
Retractors  
Separadores  
Divaricatori

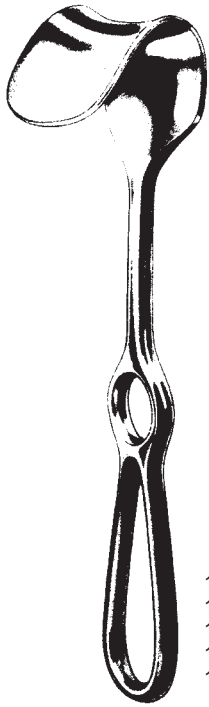

FRITSCH  
19370-40 45x40 mm  
19370-50 45x50 mm  
19370-60 45x60 mm  
19370-75 45x75 mm  
19370-85 65x85 mm  
24 cm, 9 1/2"

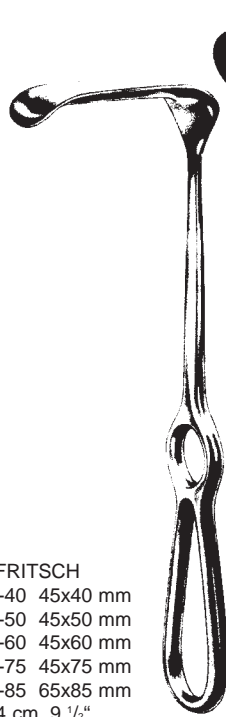

KOCHER  
19372-22  
70x25 mm  
22,5 cm, 8.9"

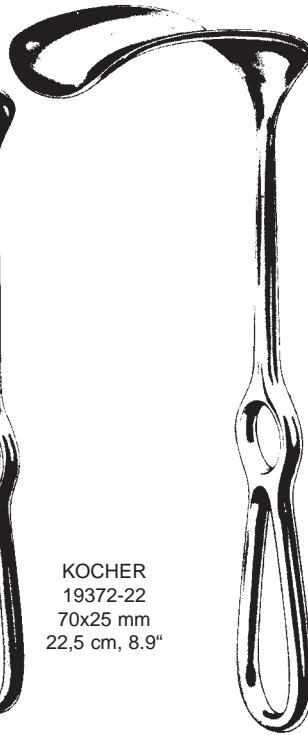

KOCHER  
19374-45 80x45 mm  
19374-55 80x55 mm  
19374-65 80x65 mm  
25 cm, 10"

50x85 mm



DOYEN  
19378-25  
25 cm, 10"

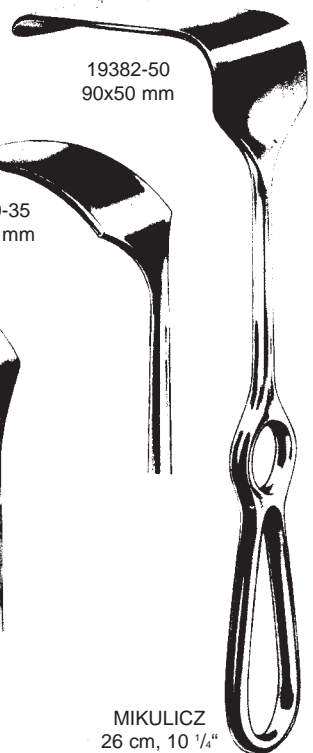

19382-50  
90x50 mm

19380-35  
95x35 mm

19380-50  
120x50 mm

19381-50  
150x50 mm

MIKULICZ  
26 cm, 10 1/4"

Wundhaken  
Retractors  
Separadores  
Divaricatori



19388-40 70x40 mm  
19388-50 70x50 mm  
19388-65 70x65 mm

MORRIS  
24,5 cm  
9 3/4"

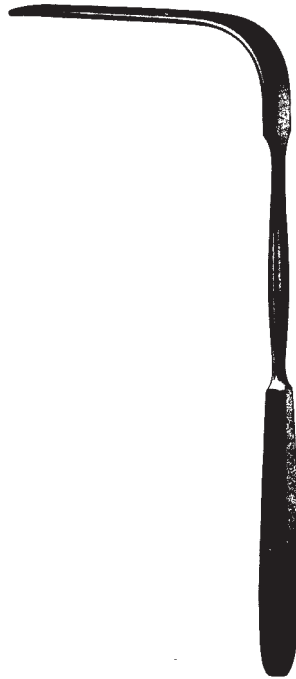

SIMON  
19480-22 115x22 mm  
19480-27 115x27 mm  
28 cm, 11"

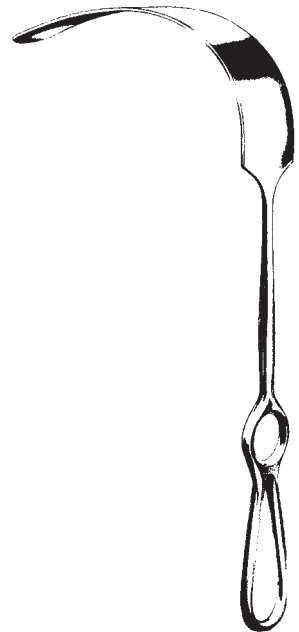

KELLY  
19385-38 160x38 mm  
19385-57 160x57 mm  
27 cm, 10 1/2"



19482-82  
82x28 mm



19482-73  
73x28 mm



19482-45  
45x25 mm

HEANEY  
19482-45 - 19482-82  
27 cm, 10 1/2"

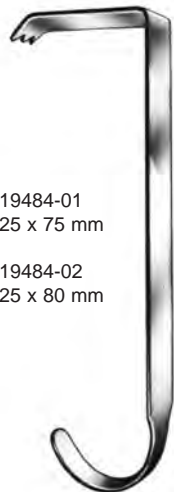

19484-01  
25 x 75 mm  
19484-02  
25 x 80 mm

HIBBS  
24 cm, 9 1/2"



125x37 mm

SAUERBRUCH  
19492-25  
25 cm, 10"

Wundhaken  
Retractors  
Separadores  
Divaricatori

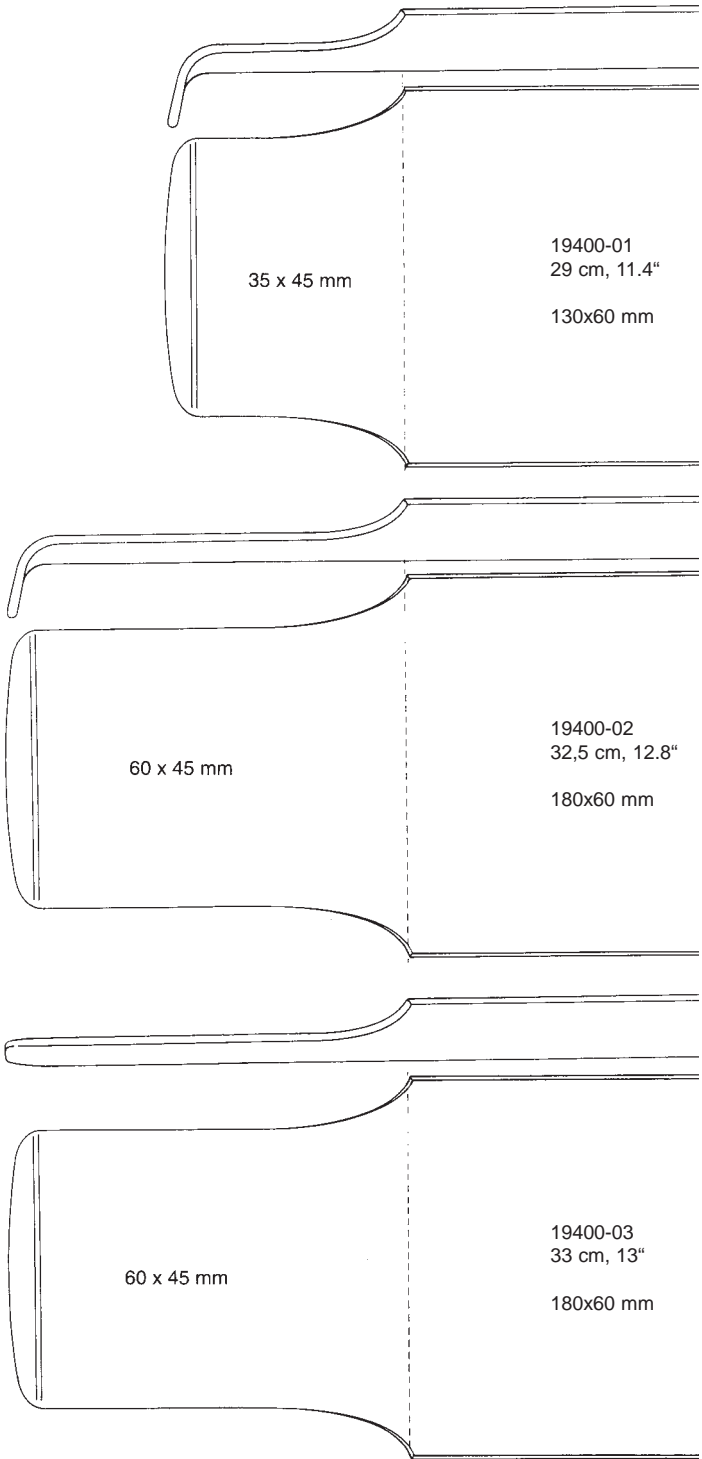

19400-01  
29 cm, 11.4"  
130x60 mm

19400-02  
32,5 cm, 12.8"  
180x60 mm

19400-03  
33 cm, 13"  
180x60 mm

Pelvis-Haken  
Pelvis retractor  
Retractor de pelvis  
Divaricatori pelvici



ST. MARKS  
19400-01 19400-03

Wundhaken  
 Retractors  
 Separadores  
 Divaricatori

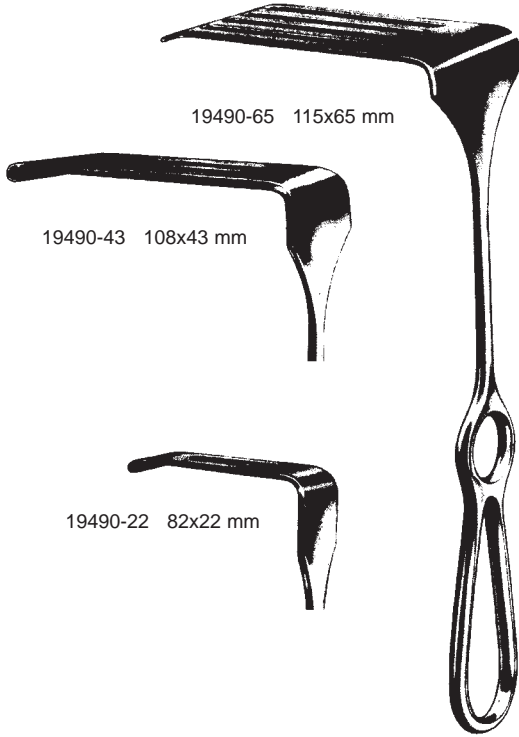

19490-65 115x65 mm

19490-43 108x43 mm

19490-22 82x22 mm

CORYLLOS (Thorax)  
 19490-22 - 19490-65  
 24 cm, 9 1/2"

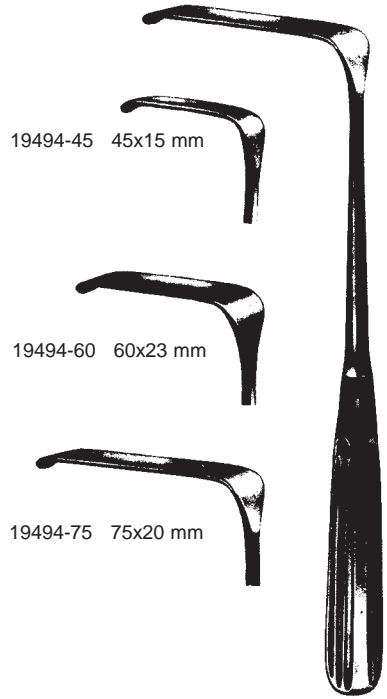

19494-45 45x15 mm

19494-60 60x23 mm

19494-75 75x20 mm

SAUERBRUCH  
 19494-45 - 19494-75  
 22,5 cm, 8,9"



DAVIDSON (Scapula)  
 19496-50 75x50 mm



DAVIDSON (Scapula)  
 19496-90 75x90 mm

Wundhaken  
Retractors  
Separadores  
Divaricatori

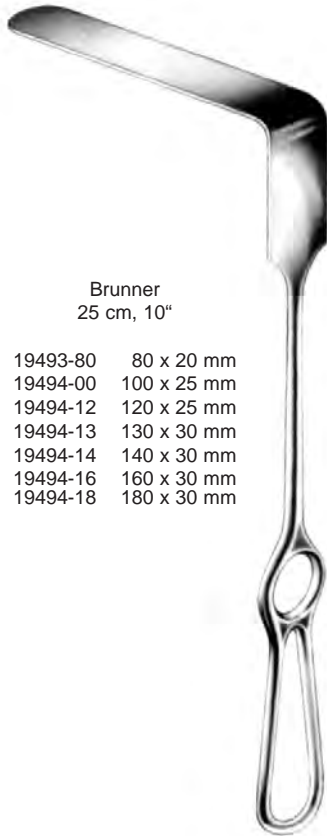

Brunner  
25 cm, 10"

19493-80	80 x 20 mm
19494-00	100 x 25 mm
19494-12	120 x 25 mm
19494-13	130 x 30 mm
19494-14	140 x 30 mm
19494-16	160 x 30 mm
19494-18	180 x 30 mm

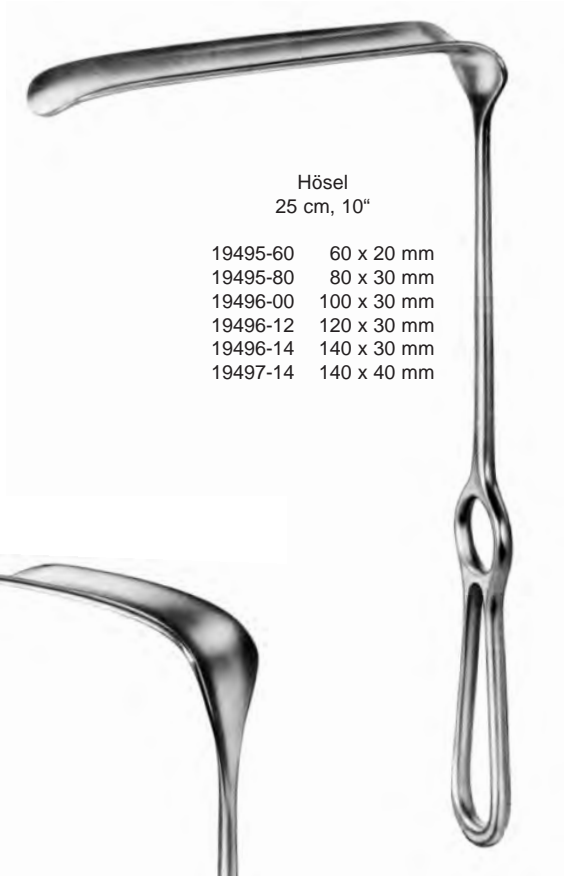

Hösel  
25 cm, 10"

19495-60	60 x 20 mm
19495-80	80 x 30 mm
19496-00	100 x 30 mm
19496-12	120 x 30 mm
19496-14	140 x 30 mm
19497-14	140 x 40 mm



Doyen-Stillé  
25 cm, 10"

19498-01	97 x 29 mm
19498-02	101 x 31 mm
19498-03	127 x 52 mm



Wundsperrer  
 Retractors  
 Separadores  
 Divaricatori

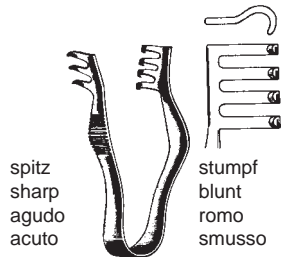

spitz  
 sharp  
 agudo  
 acuto

stumpf  
 blunt  
 romo  
 smusso

FINSEN  
 19610-07 7 cm, 2 3/4" 19611-07

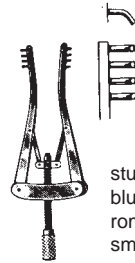

spitz  
 sharp  
 agudo  
 acuto

stumpf  
 blunt  
 romo  
 smusso

ALM  
 19620-07 7 cm, 2 3/4" 19621-07  
 19620-10 10 cm, 4" 19621-10



JANSSEN  
 19630-10  
 10 cm, 4"



JANSSEN  
 19631-10  
 10 cm, 4"



spitz  
 sharp  
 agudo  
 acuto

stumpf  
 blunt  
 romo  
 smusso

HOLZHEIMER  
 19634-10 19635-10  
 10 cm, 4"



PERKINS  
 19636-14  
 13 cm, 5 1/8"



PERKINS  
 19637-14  
 13 cm, 5 1/8"

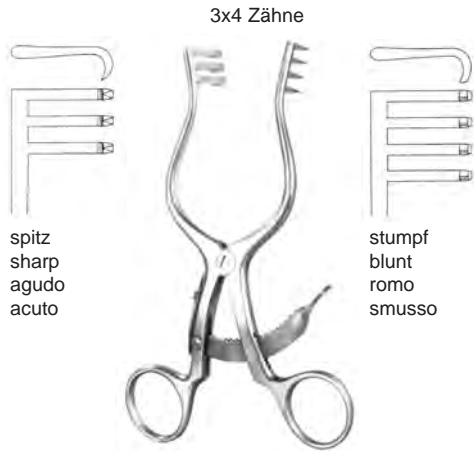

SCALP-CONTOUR  
19640-14 - 19641-14  
13,5 cm, 5 1/4"

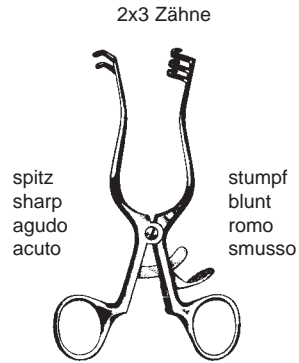

WEITLANER  
19650-10 19651-10  
11,5 cm, 4 1/2"

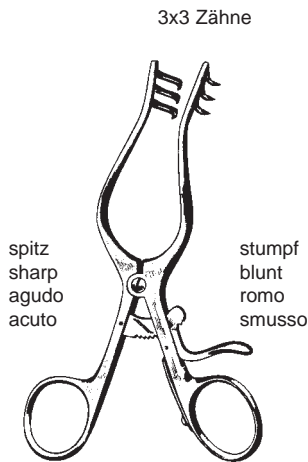

WEITLANER-WULLSTEIN  
19654-13 19655-13  
13 cm, 5 1/8"

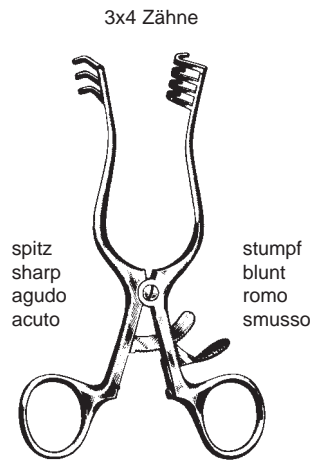

WEITLANER

19670-14	14,0 cm, 5 1/2"	19671-14
19670-16	16,5 cm, 6 1/2"	19671-16
19670-20	20,0 cm, 8"	19671-20
19670-24	24,0 cm, 9 1/2"	19671-24

Wundsperrer  
 Retractors  
 Separadores  
 Divaricatori

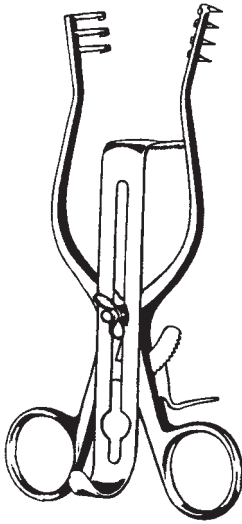

HENLEY  
 19675-00 - 19677-32  
 16,5 cm, 6 1/2"



19675-00 komplett, stumpf, 3x4 Z. und 3 Valven  
 19675-00 complete, blunt, 3x4 teeth and 3 blades  
 19675-00 completo, romo, 3x4 dientes y 3 valvas  
 19675-00 completo, smusso, 3x4 d. e 3 valve

19676-00 komplett, scharf, 3x4 Z. und 3 Valven  
 19676-00 complete, sharp, 3x4 teeth and 3 blades  
 19676-00 complete, agudo, 3x4 dientes y 3 valvas  
 19676-00 completo con retr. acuto 3x4 d. e 3 valve

19678-05 Retraktor allein, stumpf 3x4 Zähne  
 19678-05 Retractor only, blunt 3x4 teeth  
 19678-05 Separador solo, romo, 3x4 dientes  
 19678-05 Retratore solo, smusso 3x4 denti

19678-06 Retraktor allein, spitz 3x4 Zähne  
 19678-06 Retractor only, sharp 3x4 teeth  
 19678-06 Separador solo, agudo, 3x4 dientes  
 19678-06 Retratore solo, acuto 3x4 denti

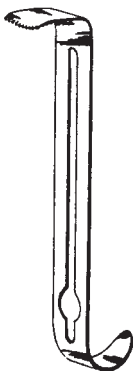

19677-19  
 16x19 mm  
 5/8" x 3/4"

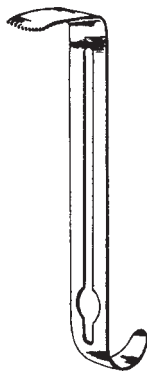

19677-25  
 16x25 mm  
 5/8" x 1"

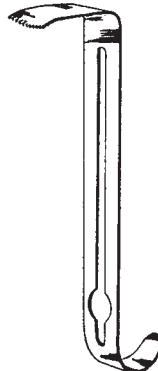

19677-32  
 16x32 mm  
 5/8" x 1 1/4"

Wundsperrer  
Retractors  
Separadores  
Divaricatori



PLESTER  
19672-11 11 cm, 4 <sup>3</sup>/<sub>8</sub>"  
stumpf - blunt - romo - smusso

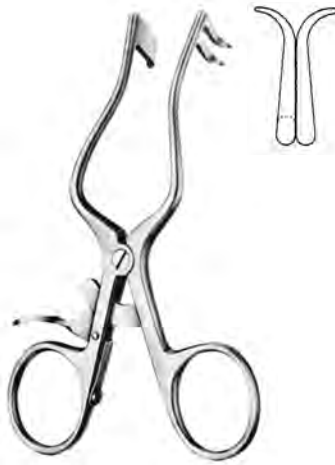

PLESTER  
19673-11 11 cm, 4 <sup>3</sup>/<sub>8</sub>"  
stumpf - blunt - romo - smusso

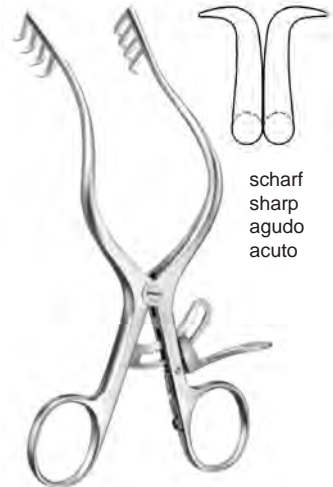

MOLLISON  
19674-15 15 cm, 6"

scharf  
sharp  
agudo  
acuto



WULLSTEIN  
19675-13  
13 cm, 5 <sup>1</sup>/<sub>8</sub>"



PLESTER  
19677-13  
13 cm, 5 <sup>1</sup>/<sub>8</sub>"

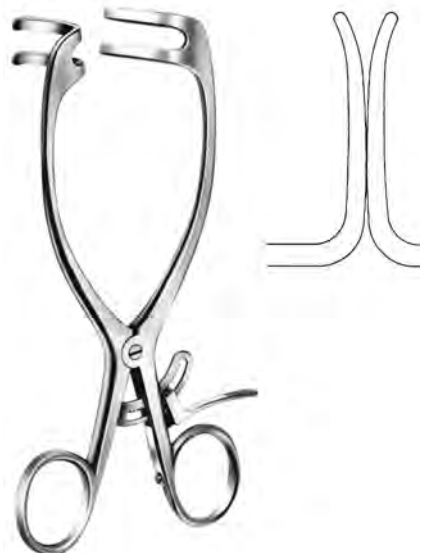

MAYO-ADAMS  
19678-16  
16,5 cm, 6 <sup>1</sup>/<sub>2</sub>"

Wundsperrer  
 Retractors  
 Separadores  
 Divaricatori

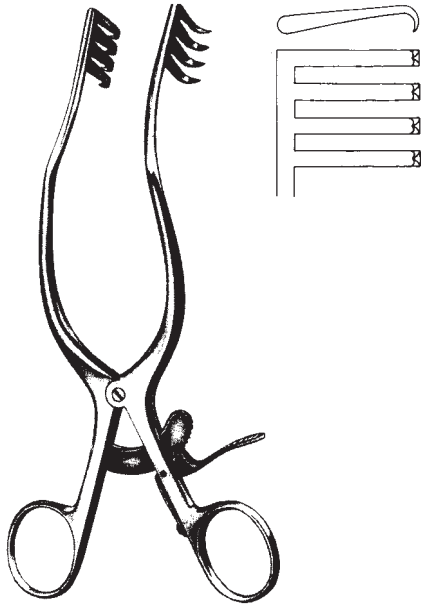

ANDERSON ADSON  
 19679-20 19,5 cm, 7 3/4"



NORFOLK / NORWICH  
 19679-22 22 cm, 8 3/4"



spitz  
 sharp  
 agudo  
 acuto  
 ADSON  
 19680-19 19 cm, 7 1/2" 19681-19

stumpf  
 blunt  
 romo  
 smusso



TRAVERS  
 19681-21 21,5 cm, 8 1/2"

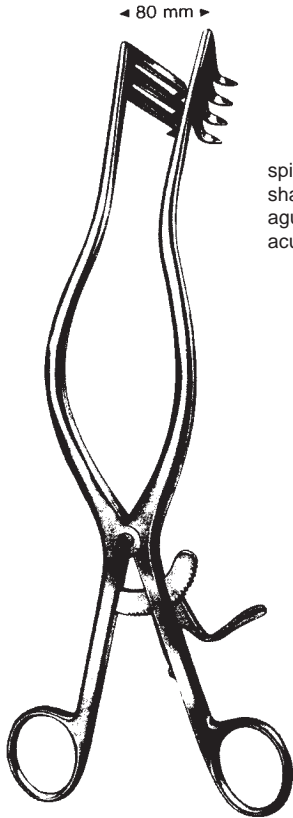

spitz  
sharp  
agudo  
acuto

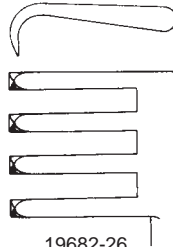

19682-26

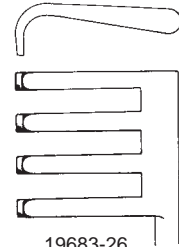

stumpf  
blunt  
romo  
smusso

19683-26

ADSON  
19682-26 - 19683-26  
26,5 cm, 10 1/2"

19684-14	14 cm, 5 1/2"
19684-16	16 cm, 6 1/4"
19684-20	20 cm, 8"
19684-26	26 cm, 10 1/4"

spitz  
sharp  
agudo  
acuto

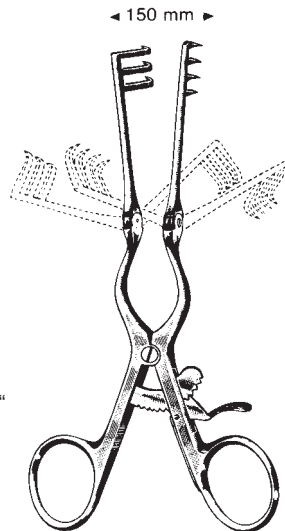

19685-14	14 cm, 5 1/2"
19685-16	16 cm, 6 1/4"
19685-20	20 cm, 8"
19685-26	26 cm, 10 1/4"

stumpf  
blunt  
romo  
smusso

ADSON

Wundsperrer  
Retractors  
Separadores  
Divaricatori



ADSON  
19686-32  
32 cm, 12 3/4"



Beckman-Adson  
31 cm, 12 1/4"

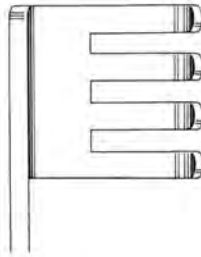

19687-01  
25 x 27 mm

stumpf  
blunt  
romo  
smusso

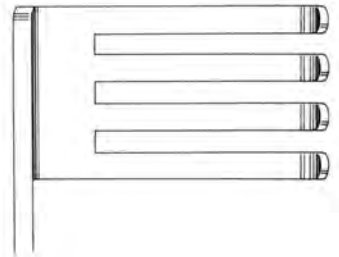

19688-01  
45 x 27 mm

stumpf  
blunt  
romo  
smusso

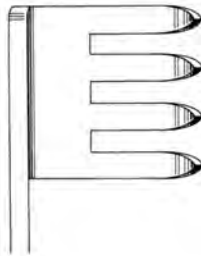

19687-02  
25 x 27 mm

scharf  
sharp  
agudo  
acuto

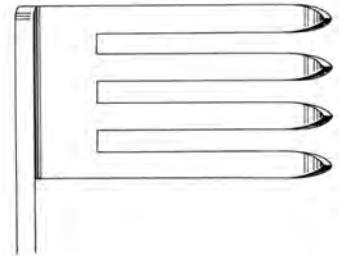

19688-02  
45 x 27 mm

scharf  
sharp  
agudo  
acuto



Wundsperrer  
Retractors  
Separadores  
Divaricatori



MARTIN  
28,5 cm, 11 1/4"

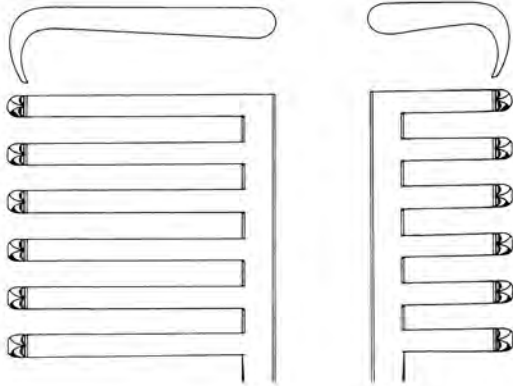

19689-01  
6x6 Zähne

scharf, lange Zähne links  
sharp, long teeth on left side  
agudo, dientes largos a la izquierda  
acuto, denti lunghe a sinistra

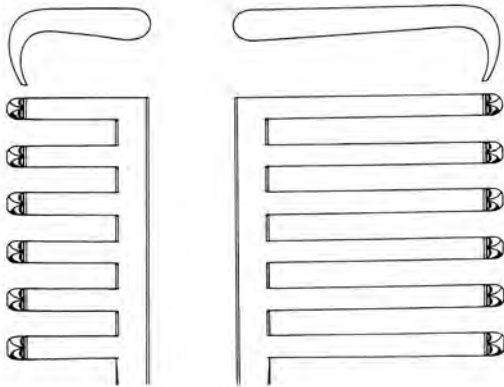

19689-02  
6x6 Zähne

scharf, lange Zähne rechts  
sharp, long teeth on right side  
agudo, dientes largos a la derecha  
acuto, denti lunghe a destra

Wundsperrer  
Retractors  
Separadores  
Divaricatori

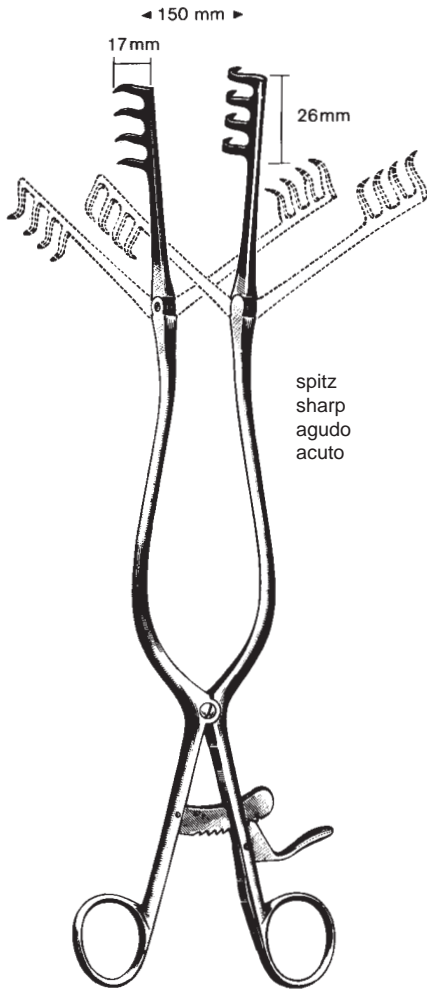

spitz  
sharp  
agudo  
acuto

BECKMANN  
19690-31  
31 cm, 12 1/4"

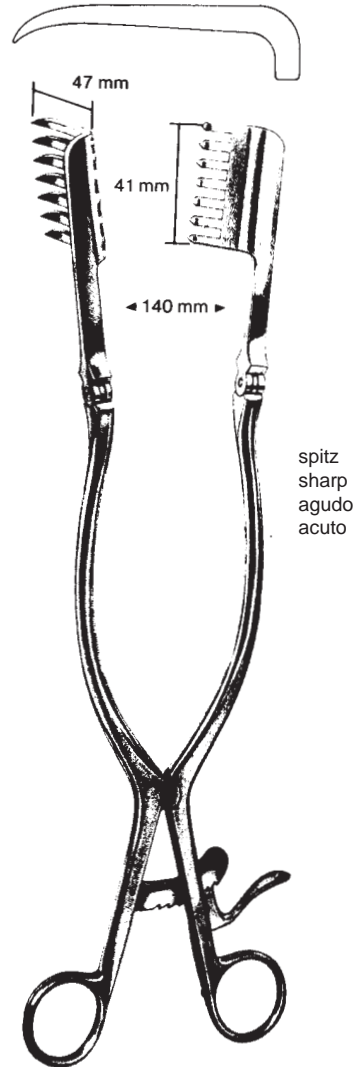

spitz  
sharp  
agudo  
acuto

BECKMANN-EATON  
19692-32  
32 cm, 12 3/4"

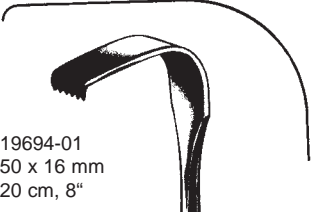

19694-01  
50 x 16 mm  
20 cm, 8"

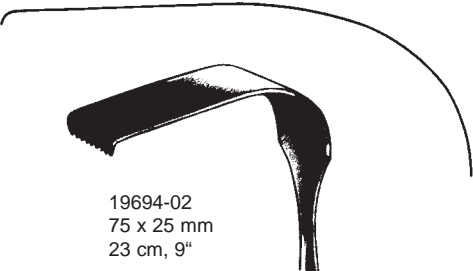

19694-02  
75 x 25 mm  
23 cm, 9"



19694-03  
90 x 50 mm  
24 cm, 9 1/2"

MEYERDING

Wundsperrer  
Retractors  
Separadores  
Divaricatori

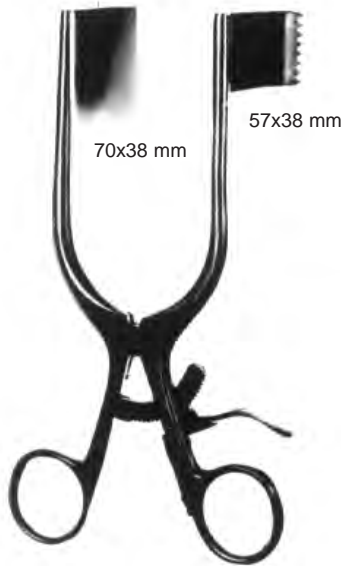

DARLING  
19696-18 18 cm, 7"

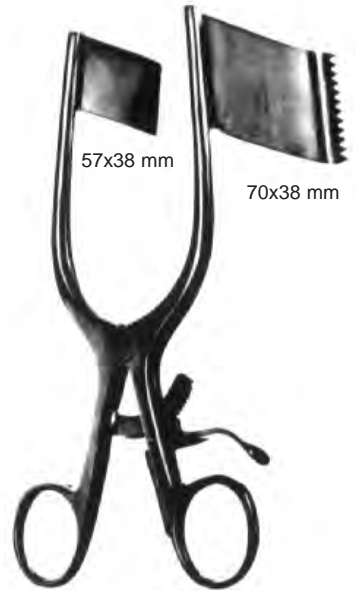

DARLING  
19698-18 18 cm, 7"



CLOWARD  
25 cm, 10"

19710-01



CLOWARD  
16 cm, 6 1/4"

19711-01



19710-40 40 mm



19711-40 40 mm



19710-45 45 mm



19711-45 45 mm



19710-50 50 mm



19711-50 50 mm

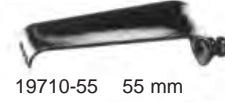

19710-55 55 mm

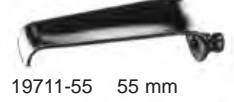

19711-55 55 mm



19710-60 60 mm



19711-60 60 mm

19710-00  
Sperrer komplett mit 5 Valven spitz  
Retractor complete with 5 blades sharp  
Separador completo con 5 valvas agudas  
Divaricatore completo con 5 valve acute

19711-00  
Sperrer komplett mit 5 Valven spitz  
Retractor complete with 5 blades sharp  
Separador completo con 5 valvas agudas  
Divaricatore completo con 5 valve acute

19712-00  
Sperrer komplett mit 5 Valven stumpf  
Retractor complete with 5 blades blunt  
Separador completo con 5 valvas romas  
Divaricatore completo con 5 valve smusse

19713-00  
Sperrer komplett mit 5 Valven stumpf  
Retractor complete with 5 blades blunt  
Separador completo con 5 valvas romas  
Divaricatore completo con 5 valve smusse

Laminektomie-Wundspreizer  
 Retractors, Cercical Spine  
 Separadores, columna vertebral  
 Divaricatori, spina cervicale



CASPAR  
 19720-00 compl.  
 (5 valven, 5 valves, 5 blades, 5 valvas, 5 valve)  
 19720-15  
 ohne Blätter, without blades, sin valvas, senza valve



CASPAR  
 19721-00 compl.  
 (5 valven, 5 valves, 5 blades, 5 valvas, 5 valve)  
 19721-15  
 ohne Blätter, without blades, sin valvas, senza valve



CASPAR  
 19724-00 compl. (5 valven, 5 valves, 5 blades, 5 valvas, 5 valve)  
 19724-11 ohne Blätter, without blades, sin valvas, senza valve



medial

CASPAR  
 19724-40 40x20 mm  
 19724-45 45x20 mm  
 19724-50 50x20 mm  
 19724-55 55x20 mm  
 19724-60 60x20 mm



lateral

CASPAR  
 19725-40 40x20 mm  
 19725-45 45x20 mm  
 19725-50 50x20 mm  
 19725-55 55x20 mm  
 19725-60 60x20 mm

Laminektomie-Wundspreizer  
 Retractors  
 Separadores  
 Divaricatori



19745-40 40 mm



19745-45 45 mm



19745-50 50 mm



19745-55 55 mm



19745-60 60 mm



19745-65 65 mm



19745-70 70 mm

CASPAR

19744-00 compl. incl. 7 Blätter, compl. incl. 7 blades, valvas, valva  
 19744-17 ohne Blätter, without blades, sin valvas, senza valve



19747-45 45 mm

19747-50 50 mm

19747-55 55 mm

19747-60 60 mm

19747-65 65 mm



CASPAR  
 19747-45 - 19747-65

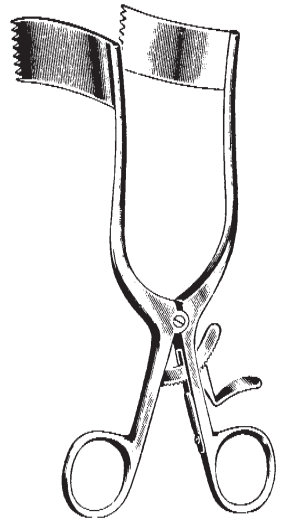

MEYERDING

17 cm, 6 3/4"

19748-01 2,5 x 3,2 cm

19748-02 2,5 x 5,4 cm

19748-03 1,9 x 6,0 cm

19748-04 2,5 x 6,0 cm

Bauchdeckenhalter  
 Abdominal Retractors  
 Separadores abdominales  
 Divaricatori addominali

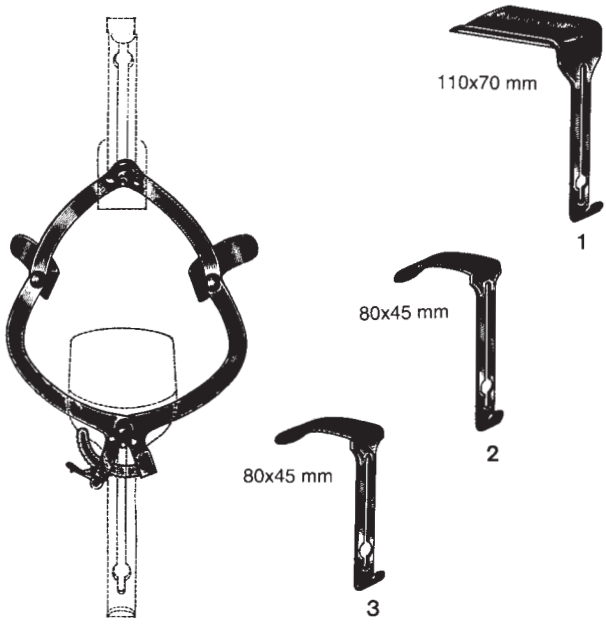

O'SULLIVAN - O'CONNOR  
 19754-00  
 compl.

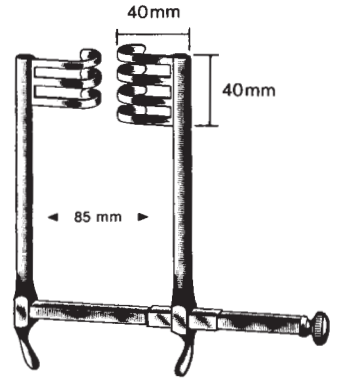

FRAZIER  
 19758-85

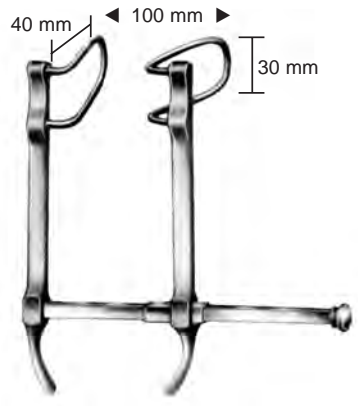

BABY GOSSET  
 19759-00

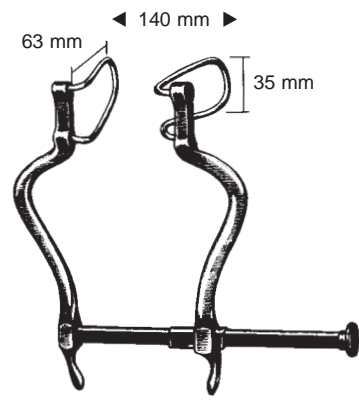

GOSSET  
 19760-14

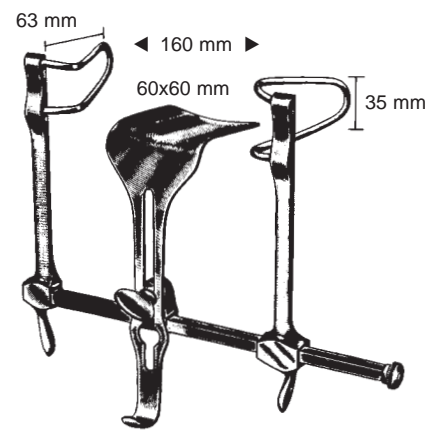

GOSSET  
 19762-16

Bauchdeckenhalter  
 Abdominal Retractors  
 Separadores abdominales  
 Divaricatori addominali

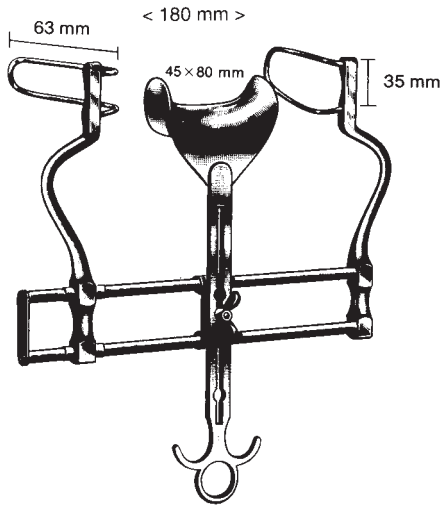

BALFOUR  
 19764-18  
 18 cm, 7"

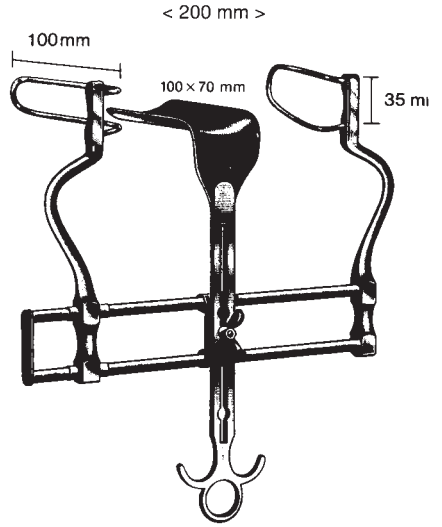

BALFOUR  
 19764-20  
 20 cm, 8"

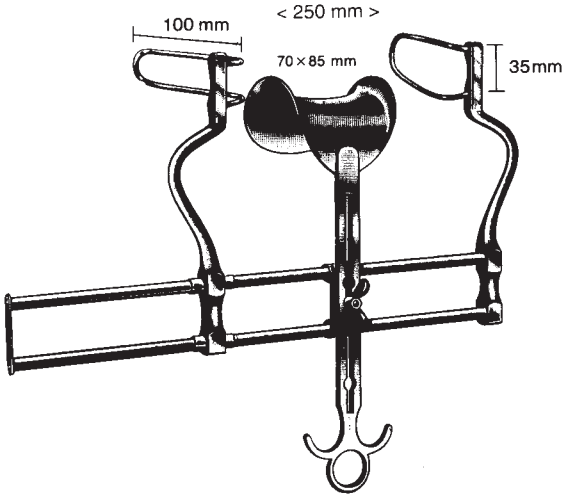

BALFOUR  
 19764-25  
 25 cm, 10"

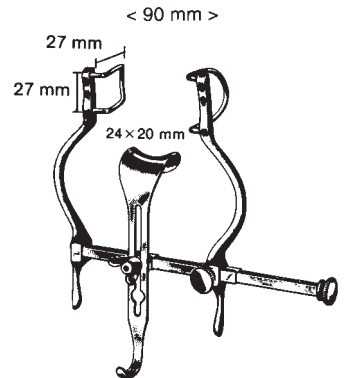

BALFOUR Baby  
 19766-90  
 9 cm, 3 1/2"



Bauchdeckenhalter  
Abdominal Retractors  
Separadores abdominales  
Divaricatori addominali

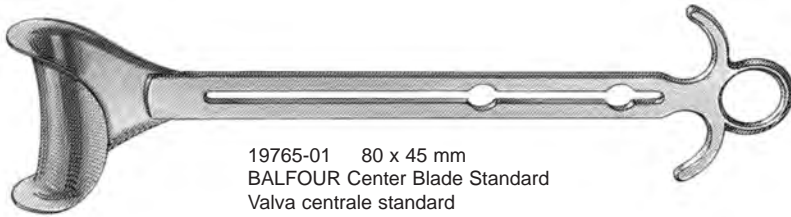

19765-01 80 x 45 mm  
BALFOUR Center Blade Standard  
Valva centrale standard  
Valva central estándar

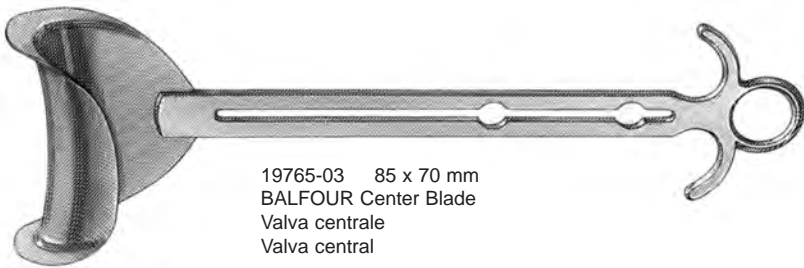

19765-03 85 x 70 mm  
BALFOUR Center Blade  
Valva centrale  
Valva central

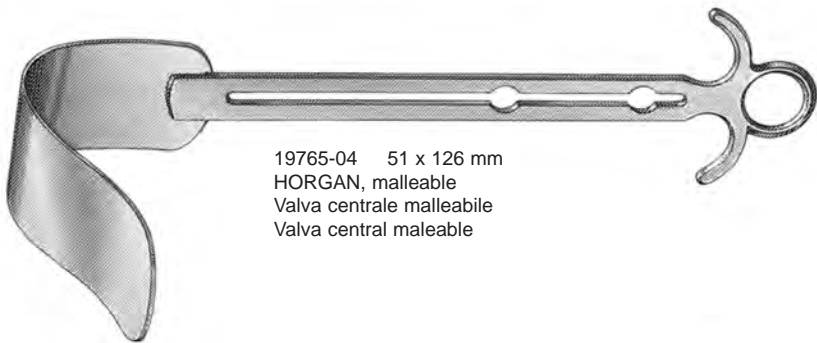

19765-04 51 x 126 mm  
HORGAN, malleable  
Valva centrale malleabile  
Valva central maleable

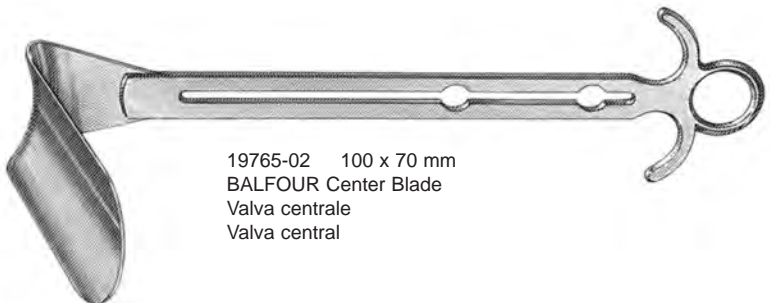

19765-02 100 x 70 mm  
BALFOUR Center Blade  
Valva centrale  
Valva central

Bauchdeckenhalter  
Abdominal Retractors  
Separadores abdominales  
Divaricatori addominali



19767-01  
Drahtvalven 6 cm (2.4") tief (Paar)  
Fenestrated blades 6 cm (2.4") deep (pair)  
Valvas de alambre 6 cm (2.4") profundidad (par)  
Valve di filo profondità 6 cm (2.4") (paio)



19767-02  
Drahtvalven 8 cm (3 1/8") tief (Paar)  
Fenestrated blades 8 cm (3 1/8") deep (pair)  
Valvas de alambre 8 cm (3 1/8") profundidad (par)  
Valve di filo profondità 8 cm (3 1/8") (paio)



BALFOUR-US  
19767-18  
komplett  
complete  
completo

Bauchdeckenhalter  
Abdominal Retractors  
Separadores abdominales  
Divaricatori addominali

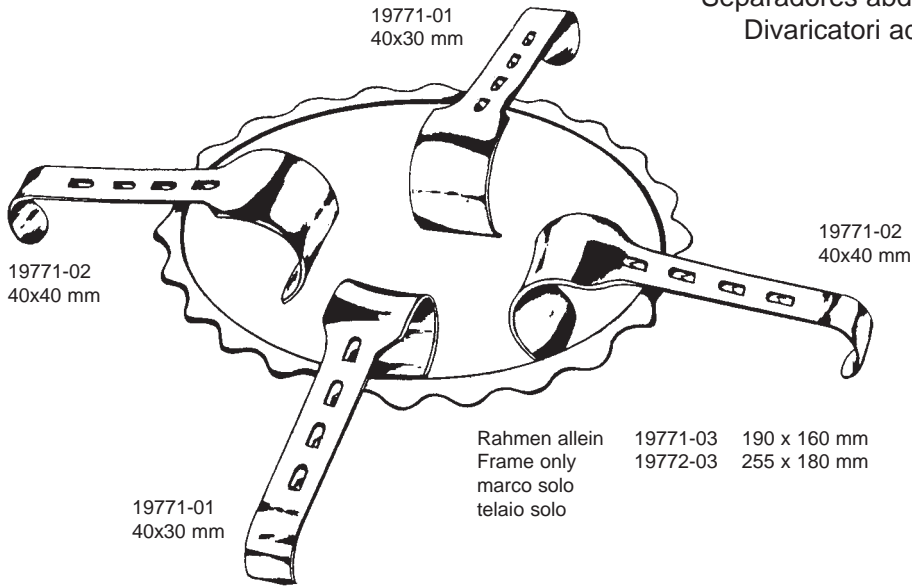

DENIS-BROWNE

19771-00 compl. Pediatric/pediatrico 190 x 160 mm  
19772-00 compl. Adult/adulto 255 x 190 mm

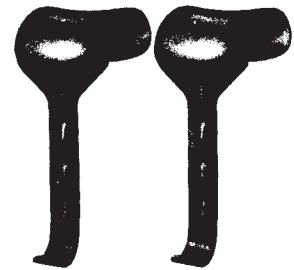

19781-55 (2 St./p.)  
40 x 55 mm breit

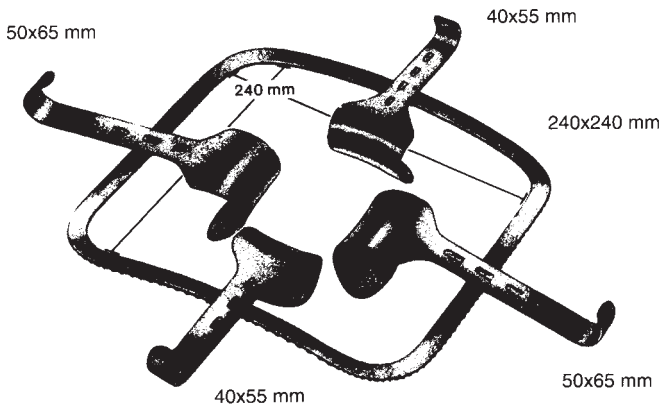

KIRSCHNER



19781-65 (2 St./p.)  
50 x 65 mm breit

19782-00 Kirschner Bauchdeckenhalter komplett bestehend aus:  
Kirschner Abdominal Retr. complete consisting of:  
Kirschner separador abdominal, completo compuesto de:  
Kirschner Divaricatore addominale completo, composto da:

19781-55 2 Rahmenhaken / 2 Hook-on Retr. / 2 separadores / 2 divaricatori 40 x 55 mm  
19781-65 2 Rahmenhaken / 2 Hook-on Retr. / 2 separadores / 2 divaricatori 50 x 65 mm  
19783-24 Rahmen fest / frame rigid / marco rigido / telaio rigido 240 x 240 mm

Bauchdeckenhalter  
 Abdominal Retractors  
 Separadores abdominales  
 Divaricatori addominali



19780-01 + 19770-01

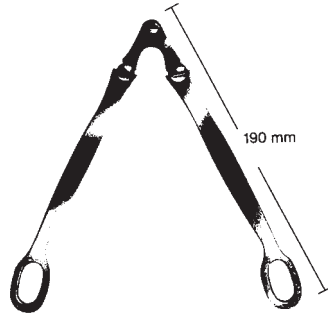

ROCHARD  
 19780-01

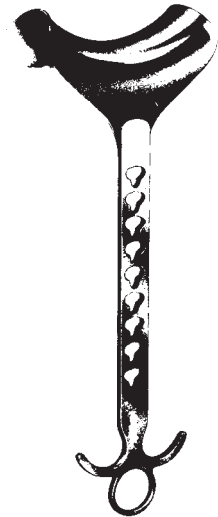

ROCHARD  
 31 cm, 12 1/4"  
 19770-01 48x 90 mm  
 19770-02 48x105 mm  
 19770-03 48x120 mm  
 19770-04 48x135 mm  
 19770-05 48x155 mm

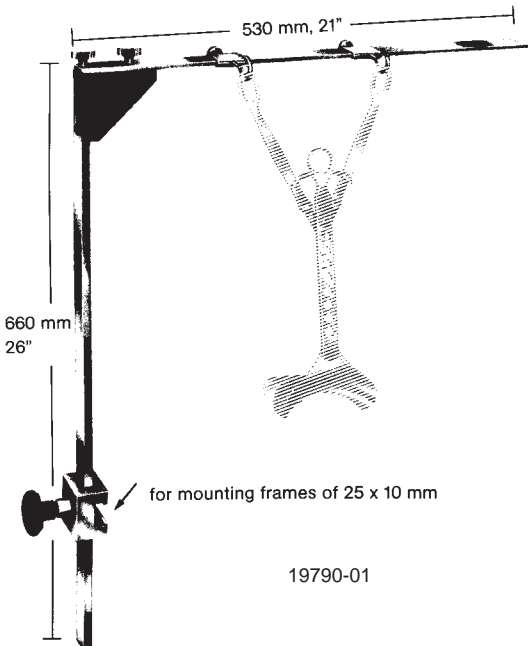

19790-01

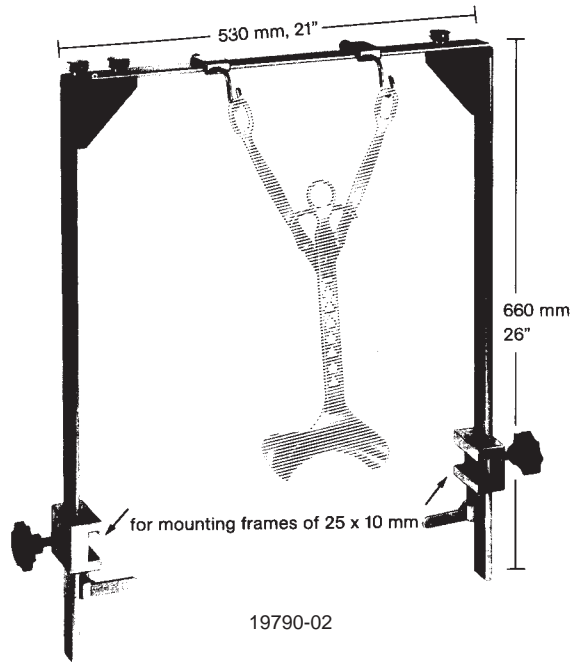

19790-02

Bauchdeckenhalter  
Abdominal Retractors  
Separadores abdominales  
Divaricatori addominali

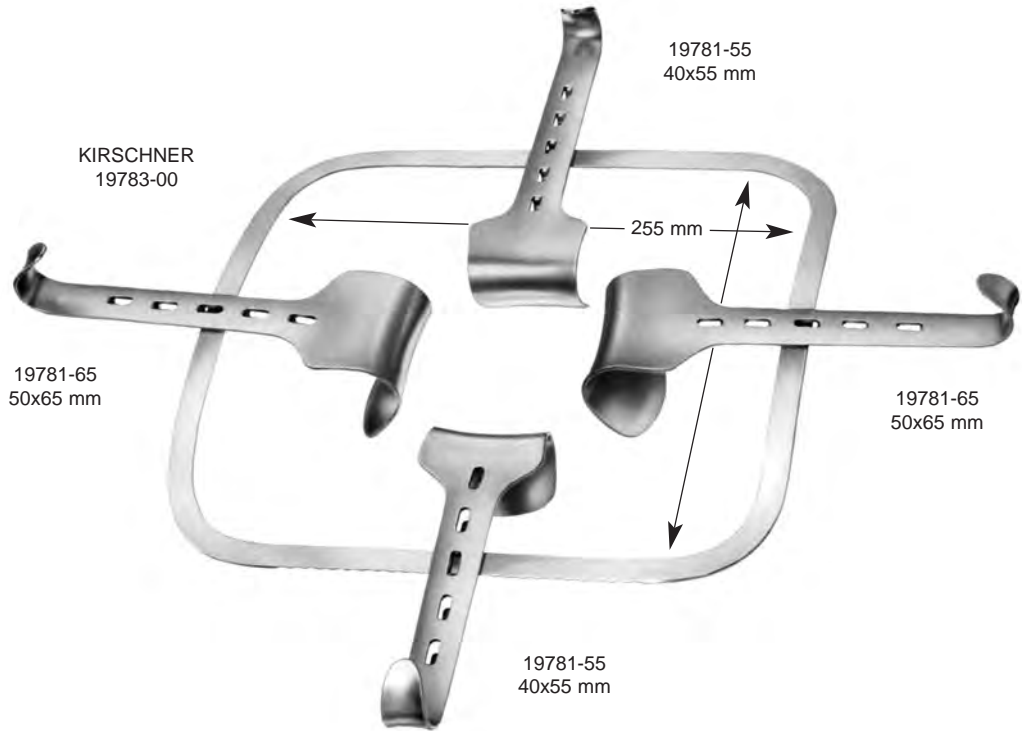

Bauchdeckenhalter  
 Abdominal Retractors  
 Separadores abdominales  
 Divaricatori addominali

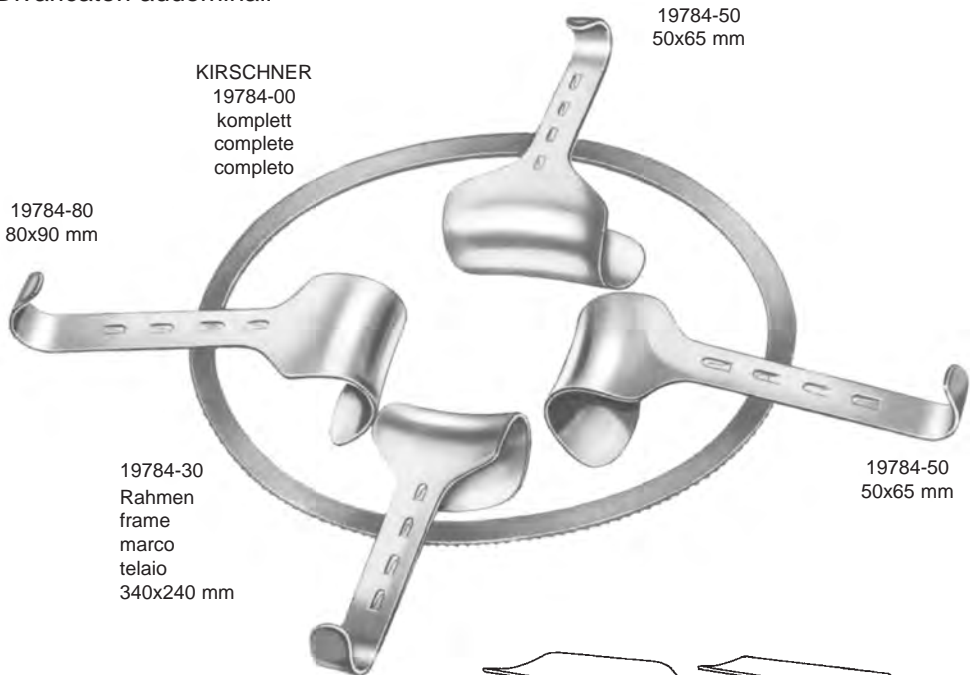

KIRSCHNER  
 19784-00  
 komplett  
 complete  
 completo

19784-50  
 50x65 mm

19784-80  
 80x90 mm

19784-30  
 Rahmen  
 frame  
 marco  
 telaio  
 340x240 mm

19784-50  
 50x65 mm

19784-80  
 80x90 mm

für Darm und Blase  
 for intestine and bladder  
 para intestino y vejiga  
 per intestino e vescica

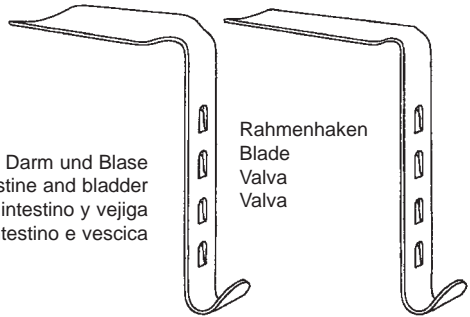

Rahmenhaken  
 Blade  
 Valva  
 Valva

19784-98  
 98x50 mm

19784-99  
 105x35 mm

für adipöse Patienten  
 for obese patients  
 para pacientes obesos  
 per pazienti obesi

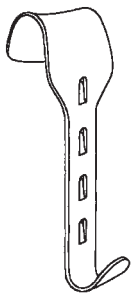

19784-40  
 40x55 mm

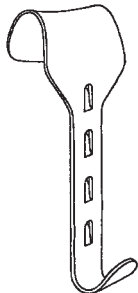

19784-50  
 50x65 mm

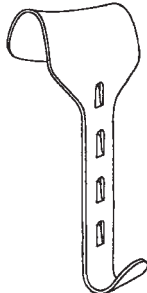

19784-60  
 60x85 mm

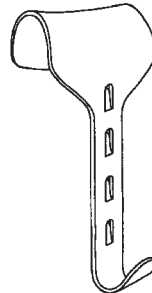

19784-78  
 78x65 mm

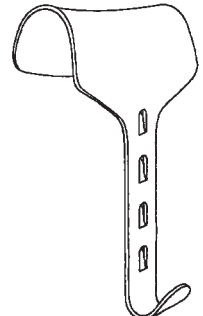

19784-80  
 80x90 mm

Arm System  
 Arm System  
 Sistema de brazo  
 Sistema braccio



19795-01  
 Armsystem Radius 310/420 mm komplett mit Wundhakenhalter und U-Stativ Ø 16 mm, 400 mm hoch, 400 mm breit, 170 mm tief.  
 Arm System, radius 310/420 mm, including retractor and U-stand Ø 16 mm, 400 mm high, 400 mm wide, 170 mm deep.



19795-02  
 Armsystem Radius 310/420 mm komplett mit Stativ, Klemmschale und Endoskophalter Ø 8/10 mm.  
 Arm System, radius 310/420 mm, including stand, clamp, endoscope holder Ø 8/10 mm.



19798-01  
 Einschlauchhalterung  
 Single tube holder



19798-02  
 Endoskophalterung Universal  
 Ø 3-10 mm  
 Endoscope holder Universal  
 Ø 3-10 mm



19798-03  
 Universelle  
 Wundhakenhalterung  
 Universal retractor holder

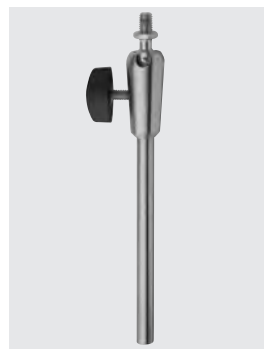

19798-04  
 Gelenkverlängerung  
 180 mm lang mit Feststellung  
 Extended articulation  
 180 mm long, lockable



**19799-01**  
 Klemmsocle aus rostfreiem Stahl, für ein höhenverstellbares Stativ Ø 16 mm, elektrisch isoliert bis 1,5 kV AC, Spannweite 35 mm für Schienen 25/32 x 8/12 mm.  
 Clamp socket made of stainless steel, for height-adjustable stand Ø 16 mm, electrically insulated up to 1.5 kV AC, holding width of 35 mm for rails 25/32 x 8/12 mm.



**19799-02**  
 Klemmsocle aus rostfreiem Stahl, für ein höhenverstellbares Stativ Ø 16 mm, elektrisch isoliert bis 1,5 kV AC, Spannweite 35 mm für Schienen 25/32 x 8/12 mm.  
 Clamp socket made of stainless steel, for height-adjustable stand Ø 16 mm, electrically insulated up to 1.5 kV AC, holding width of 35 mm for rails 25/32 x 8/12 mm.



**19799-03**  
 Leichtmetall-Klemmsocle Spannweite 35 mm, für ein Schraubstativ mit Ø 16 mm/M10, für Schienen 25/35 x 8/10 und Rohre Ø 12 - 35 mm.  
 Clamp socket made of light metal, holding width 35 mm, for screw stand Ø 16 mm/M10, for rails 25/35 x 8/10 and tubes Ø 12 - 35 mm.



**19799-04**  
 Leichtmetall-Klemmsocle Spannweite 50 mm, für ein höhenverstellbares Stativ Ø 16 mm, für Schienen 25/35 x 8/10 und Rohre Ø 12 - 35 mm.  
 Clamp socket made of light metal, holding width 50 mm, for height-adjustable stand Ø 16 mm, for rails 25/35 x 8/10 and tubes Ø 12 - 35 mm.



**19799-05**  
 Klemmsocle aus rostfreiem Stahl, für ein höhenverstellbares Stativ Ø 16 mm, elektrisch isoliert bis 4,5 kV AC, Spannweite 50 mm für Schienen 25/32 x 8/12 mm.  
 Clamp socket made of stainless steel, for height-adjustable stand Ø 16 mm, electrically insulated up to 4.5 kV AC, holding width of 50 mm for rails 25/32 x 8/12 mm.



**19799-06**  
 Leichtmetall-Klemmsocle Spannweite 50 mm, für ein Schraubstativ mit Ø 16 mm/M10, für Schienen 25/35 x 8/10 und Rohre Ø 12 - 35 mm.  
 Clamp socket made of light metal, holding width 50 mm, for screw stand Ø 16 mm/M10, for rails 25/35 x 8/10 and tubes Ø 12 - 35 mm.



Bauchdeckenhalter, Wundsperrer  
 Abdominal Retractors, Retractors  
 Separadores abdominales, Separadores  
 Divaricatori addominali, Divaricatori

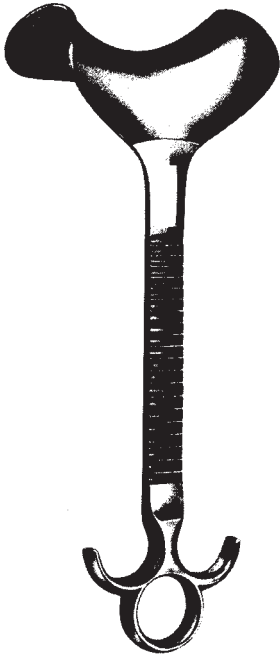

DOYEN

28 cm, 11"

- 19800-01 48x 90 mm
- 19800-02 48x105 mm
- 19800-03 48x120 mm
- 19800-04 48x135 mm

< 100 mm >

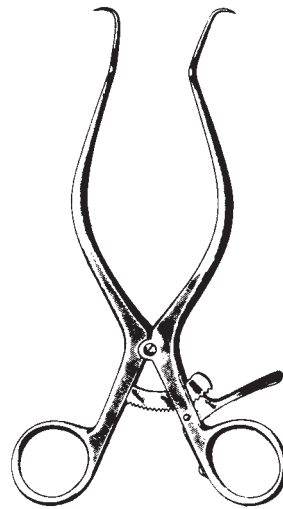

GELPI

- 19802-09 9 cm, 3 1/2"
- 19802-11 11 cm, 4 3/8"
- 19802-14 14 cm, 5 1/2"
- 19802-16 16 cm, 6 1/4"
- 19802-18 18 cm, 7"



DE BAKEY

19803-14

14,5 cm, 5 3/4"

Wundsperrer  
Retractors  
Separadores  
Divaricatori

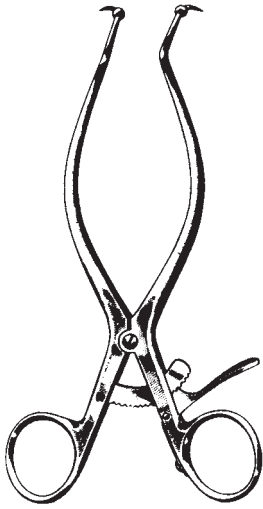

GELPI  
19804-18  
18 cm, 7"



JACKSON BURROWS  
19805-18  
18,5 cm, 7 1/4"

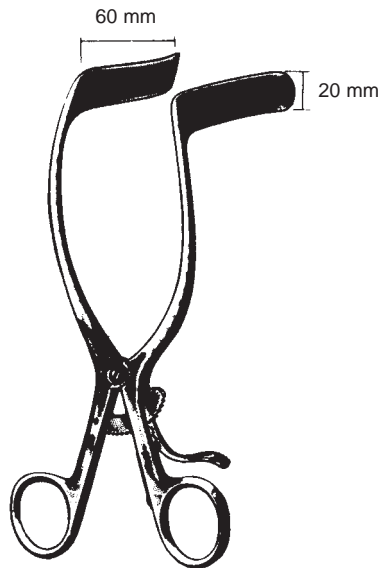

RIGBY  
19806-18  
18 cm, 7"

Bauchdeckenhalter  
Abdominal Retractors  
Separadores abdominales  
Divaricatori addominali

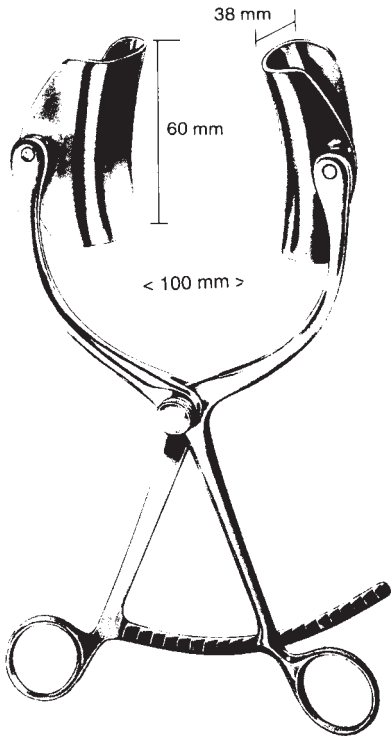

COLLIN  
19810-22

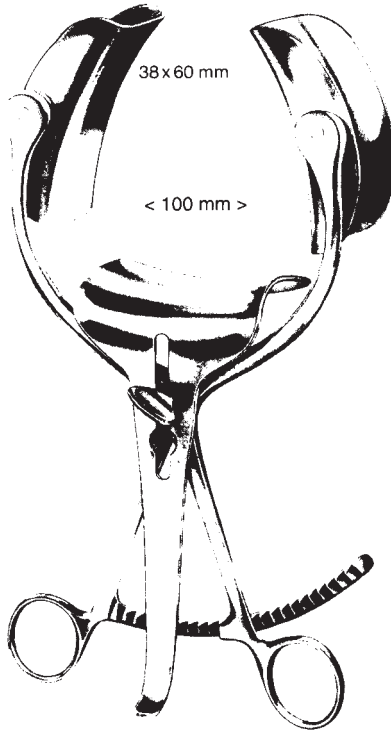

COLLIN  
19812-60

Bauchdeckenhalter  
 Abdominal Retractors  
 Separadores abdominales  
 Divaricatori addominali

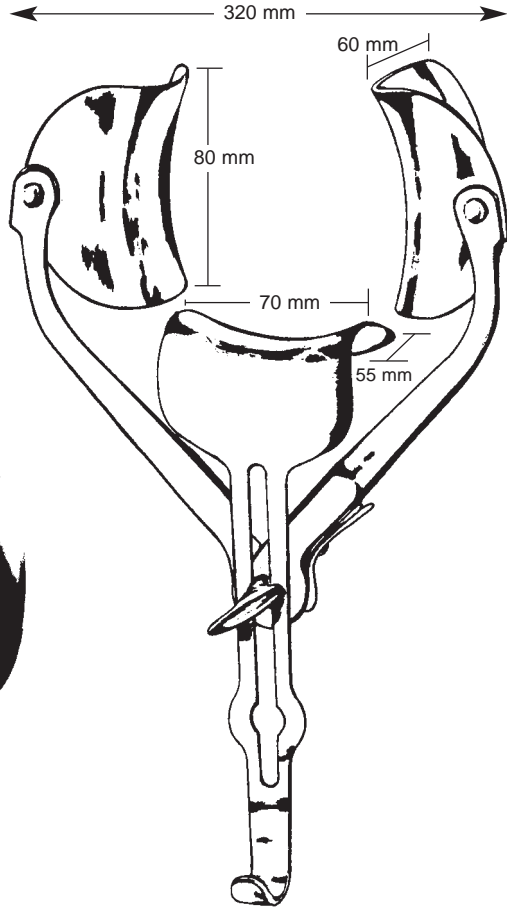

RICARD  
 19813-00 30 cm, 11 3/4"  
 komplett / complete / completo

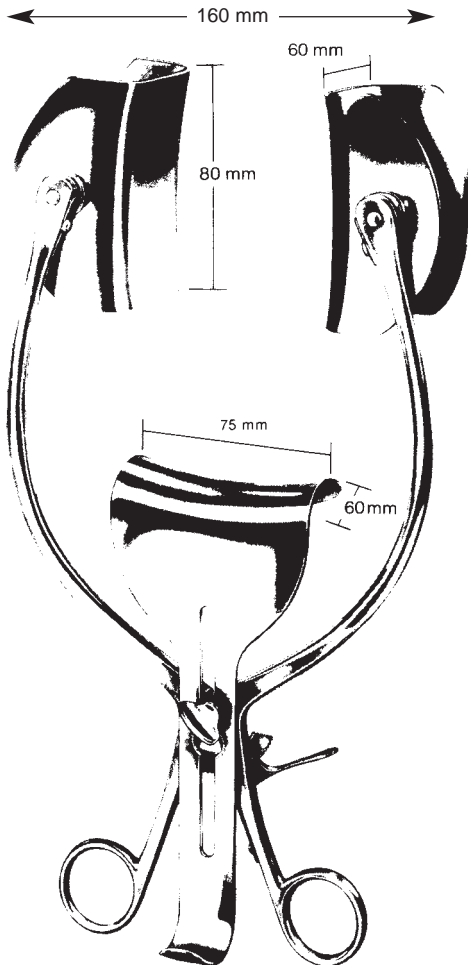

COLLIN Loktite  
 19816-00 31 cm, 12 1/4"  
 komplett / complete / completo

Back holder Abdominal Retractor  
Operation Table Set

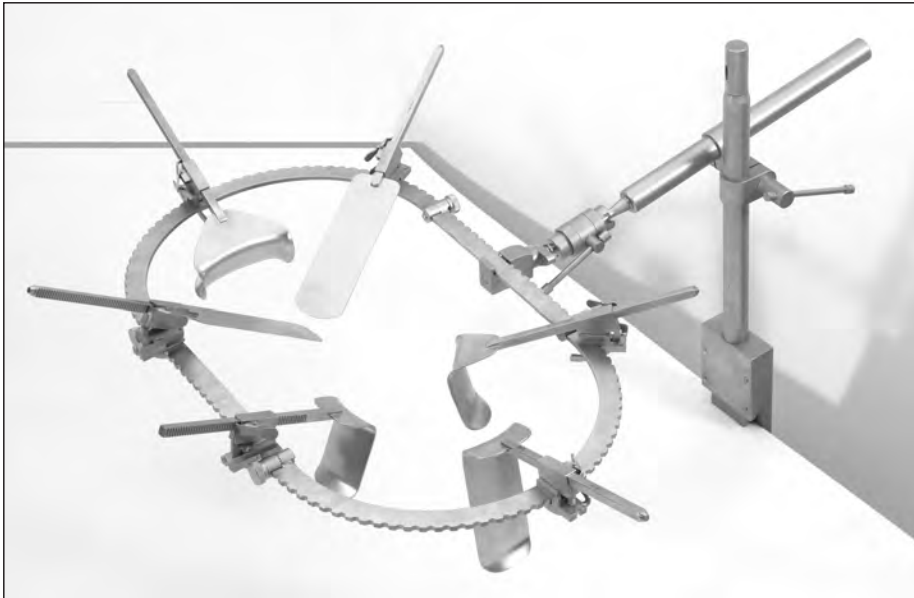

Complete Fixed Abdominal Retractor Set  
Set completo divaricatore addominale con sistema di montaggio modulare

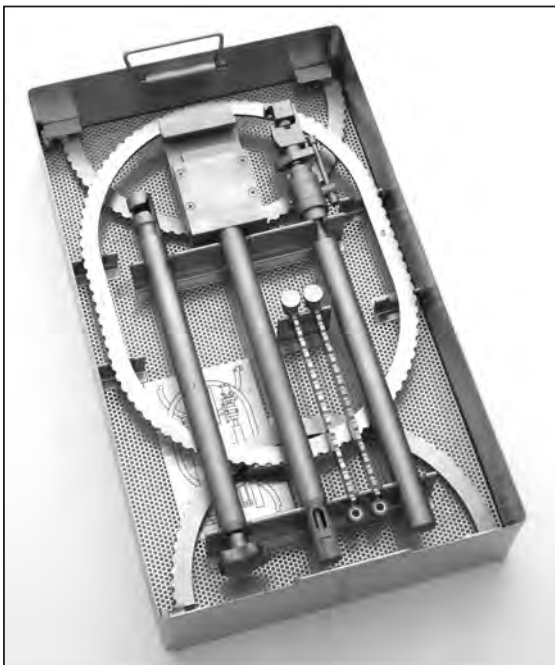

The many components of the **Back holder Abdominal Retractor Operation Table Set** can all be neatly arranged into autoclave sized containers with diagrams that direct instrument handlers on proper placement of each component.

*A major convenience in care and maintenance  
of the Retractor Set*

**Sterilization Container & Baskets**

Description	Product No
Table Fixation & Ring Case	19820-90
Blade & Accessories Case	19820-91

**Back holder Abdominal Retractor  
Operation Table Set**

<b>Description</b>	<b>Product No</b>	<i>Composto da</i>	
Complete Abdominal Retractor Set	19820-99	Accoppiatore	19821-01
		Barra orizzontale	19821-02
<i>Includes</i>		Morsetto di accoppiamento	19821-04
Table Post	19821-01	Anello ovale	19820-02
Horizontal Bar	19821-02	No. 2 retrattori malleabili, 51x152 mm	19825-06
1" Post Coupling	19821-04	No. 2 Valve Kelly, dim. 51x76 mm	19822-23
Oval Ring	19820-02	Valva Kelly	19822-24
2" X 6" Malleable Retractor (2 ea)	19825-06	Valva Balfour	19823-33
2" X 3" Kelly Retractor (2 ea)	19822-23	Morsetto trasportabile con trasporto ad intervallo progressivo di 2 mm	19820-10
2" X 4" Kelly Retractor	19822-24	Morsetto articolato multidisciplinare con funzione movimento assiale orizzontale e verticale	19820-20
Balfour Retractor	19833-33	Anello rotondo circolare, dimensione 226 mm	19820-01
Ratchet Mechanism (2 ea)	19820-10	Anello ovale 266x367 mm	19820-02
Tilt Ratchet Mechanism (6 ea)	19820-20	Anello a segmento 266x495 mm	19820-03
Segmented Ring	19820-03	Retrattore malleabile 38x152 mm	19824-06
1 1/2" X 6" Malleable Retractor	19824-06	Retrattore malleabile 76x152 mm	19826-06
3" x 6" Malleable Retractor	19826-06	Valva Kelly, 51x127 mm	19822-25
2" X 5" Kelly Retractor	19822-25	Valva Kelly, 51x152 mm	19822-26
2" X 6" Kelly Retractor	19822-26	Barra flessibile orizzontale	19821-03
Horizontal Flex Bar	19821-03	Retrattore Harrington 63x143 mm	19831-25
Harrington Retractor	19831-25	Retrattore con punta Gelpi	19834-01
Gelpi Retractor	19834-01		
<i>Accessories</i>		<i>Accessori:</i>	
Table Fixation & Ring Case	19820-90	<i>Container vuoto in acciaio inox dotato con griglia interna</i>	
Blades & Accessories Case	19820-91	Descrizione	
		Container in acciaio inox dotato di griglia interna per Accessori di fissazione, anelli e barre	19820-90
		Container in acciaio inox dotato di griglia interna per morsetti e divaricatori	19820-91



**Malleable Retractors with Protective Edge**

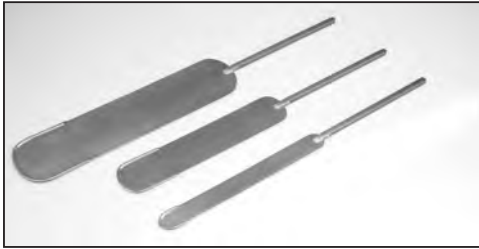

Description	Product No
1 1/2" x 6" 38 x 152 mm	19824-06
2" x 6" 51 x 152 mm	19825-06
3" x 6" 76 x 152 mm	19826-06

**Specialty Retractors**

Description	Product No
Balfour Retractor 2 5/8" x 3" 67 x 76 mm	19833-33
Gelpi Point Retractor	19834-01



**Harrington Retractors**

Description	Product No
Blade 2.5" x 5 5/8" 63 x 143 mm	19831-25



Description	Product No
Blade 2" x 1 1/2"	19822-21
Blade 2" x 2"	19822-22
Blade 2" x 2 1/2"	19822-22L
Blade 2" x 3"	19822-23
Blade 2" x 4"	19822-24
Blade 2" x 5"	19822-25
Blade 2" x 6"	19822-26



Description	Product No
Blade 1" x 1 1/2" 25 x 38 mm	19822-01
Blade 1" x 2 1/2" 25 x 63 mm	19822-02



**Tilt Ratchet Mechanism** allows extensions or retractions along the horizontal axis and allows vertical movement of retractor blade with a second ratchet

**Product No** 19820-20

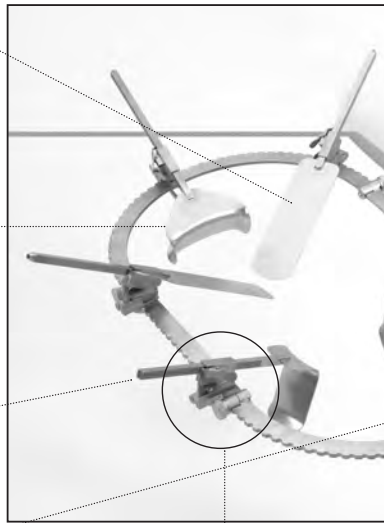

**Table Mounting Components**

**Description**                      **Product No**  
 1" Post Coupler                      19821-04

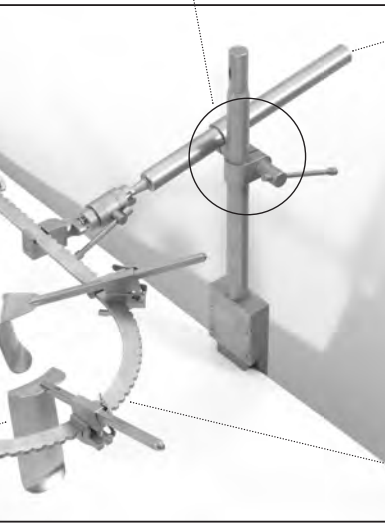

**Fixed Ratchet Mechanism** allows extension or retraction along the horizontal axis at 2mm intervals

**Product No** 19820-10



**Table Mounting Components**

Table Post                                      19821-01  
 Horizontal Bar                                19821-02  
 Horizontal Flex Bar                          19821-03



**Retractor Rings**

<b>Description</b>	<b>Product No</b>
Round Ring 10.5 inch / 266 mm	19820-01
Oval Ring 10.5 x 14.5 inch / 266 x 367 mm	19820-02
Segmented Ring 10.5 x 19.5 inch / 266 x 495 mm	19820-03
(Consists of one 10.5 inch Round Ring and two 8 inch straight segments)	



Laminektomiespreizer  
 Laminectomy Retractors  
 Separadores para laminectomia  
 Divaricatori per laminectomia



19910-00  
 SCOVILLE-HAVERFIELD  
 Rahmen allein  
 Frame only  
 Marco solo  
 Telaio solo



19911-00  
 SCOVILLE  
 Rahmen allein  
 Frame only  
 Marco solo  
 Telaio solo



SCOVILLE  
 50 mm, 2"  
 19912-50



SCOVILLE  
 70 mm, 2 3/4"  
 19912-70



SCOVILLE  
 19914-41 41 x 38 mm  
 19914-67 67 x 44 mm



TAYLOR  
 19915-48 48 x 50 mm  
 19915-64 64 x 50 mm  
 19916-64 64 x 64 mm  
 19916-80 80 x 57 mm



SCOVILLE  
 50 mm, 2"  
 19913-50



SCOVILLE  
 70 mm, 2 3/4"  
 19913-70



SCOVILLE  
 19917-64 64 x 25 mm  
 19918-64 64 x 50 mm  
 19918-88 88 x 25 mm

Wundhaken für plastische Chirurgie  
 Retractors for plastic surgery  
 Separadores para cirugía plástica  
 Divaricatore per chirurgia plastica



19970-01  
 37 x 70 mm  
 22 x 54 mm

BREAST  
 31 cm, 12 1/4"



CORONAL BLOW LIFT  
 19980-18  
 18 cm, 7"



YANCOSKIE  
 19990-18  
 18 cm, 7"



FREEMAN  
 19995-38 18 cm, 7"  
 38 mm, 1 1/2" wide

19995-22 18 cm, 7"  
 22 mm, 7/8" wide



ANDERSON  
 19998-03 12 cm, 4 3/4" 3 prong  
 3 rebbi

19998-05 12 cm, 4 3/4" 5 prong  
 5 rebbi

Sonden  
Probes, Directors  
Sondas, estiletes  
Sonde, specilli



2 mm ø

11,5 cm, 4 1/2" 21102-11  
13,0 cm, 5 1/8" 21102-13  
14,5 cm, 5 3/4" 21102-14  
16,0 cm, 6 1/4" 21102-16  
18,0 cm, 7" 21102-18  
20,0 cm, 8" 21102-20  
25,0 cm, 10" 21102-25



1 mm ø

21104-11  
21104-13  
21104-14  
21104-16  
21104-18  
21104-20  
21104-25



2 mm ø

21106-11  
21106-13  
21106-14  
21106-16  
21106-18  
21106-20  
21106-25



21108-14  
14,5 cm, 5 3/4"



**BRODIE**  
21109-18  
18 cm  
7"



13,0 cm, 5 1/8" 21110-13  
14,5 cm, 5 3/4" 21110-14  
16,0 cm, 6 1/4" 21110-16  
18,0 cm, 7" 21110-18  
20,0 cm, 8" 21110-20



**DOYEN**  
21111-14  
14 cm  
5 1/2"



21112-14  
14,5 cm  
5 3/4"



**STACKE**  
21115-10  
10,5 cm  
4.1"



**NELATON**  
21120-16  
16 cm  
6 1/4"



**FISH**  
21121-14  
14 cm, 5 1/2"  
21121-18  
18 cm, 7"



**WATSON-CHEYNE**  
21122-13  
13 cm, 5 1/4"  
21122-18  
18 cm, 7"

Fistelsonden  
Fistula Probes  
Sondas para fistula  
Sonde per fistole



LOCKHART-MUMMERY  
21125-01  
16,5 cm, 6 1/2"

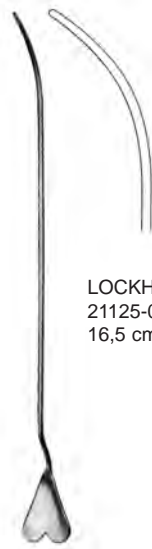

LOCKHART-MUMMERY  
21125-02  
16,5 cm, 6 1/2"

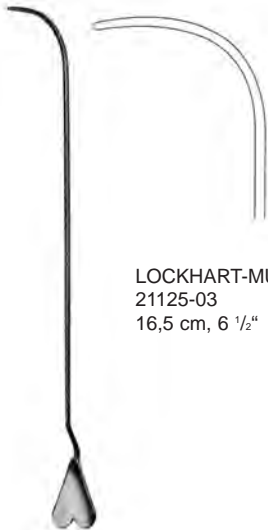

LOCKHART-MUMMERY  
21125-03  
16,5 cm, 6 1/2"



LOCKHART-MUMMERY  
21125-04  
16,5 cm, 6 1/2"

Krampfader-Besteck in Metalletui  
 Varicose vein probe set in metal case  
 Juego para várices en estuche de metal  
 Astuccio per varici in scatola di metallo

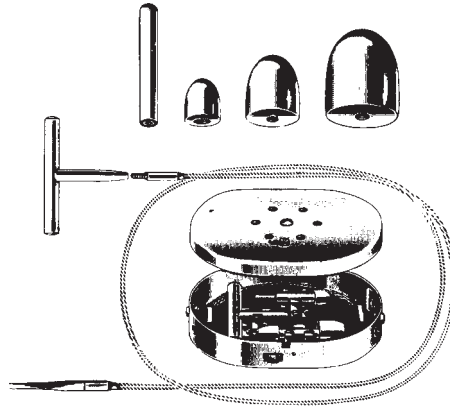

NABATOFF  
 21150-00  
 135x100x25 mm  
 compl.

Ersatzteile  
 Spare parts  
 Piezas de repuesto  
 Pezzi di ricambio

21150-02



21150-80



Handgriff  
 Handle only  
 Mango suelto  
 Manico solo

21150-90

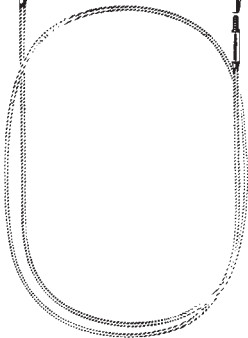

Zugseil  
 cable flexible  
 cable de traccion flex.  
 Corda di trazione fless.



21150-03  
 3 mm ø



21150-06  
 6 mm ø



21150-09  
 9 mm ø



21150-12  
 12 mm ø



21150-15  
 15 mm ø

Sondenspitzen  
 Probe Tip  
 Puntas sueltas  
 Punta

Varizeninstrumente  
 Varix Instruments  
 Instrumentos para varices  
 Strumenti per varici



VARADY  
 21154-01  
 180 mm, 7"



VARADY  
 21154-02  
 180 mm, 7"



VARADY  
 21154-03  
 180 mm, 7"



VARADY  
 21154-04  
 175 mm, 6.9"



VARADY  
 21154-05  
 170 mm, 6 3/4"



VARADY  
 21154-06  
 170 mm, 6 3/4"

21162-12  
 12 cm, 4 3/4"  
 Griff  
 Handle  
 Mango  
 Manico



21160-04  
 -  
 21160-14

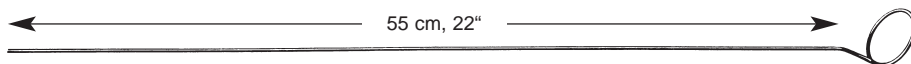

21160-04  
 4 mm ø



21160-06  
 6 mm ø



21160-07  
 7 mm ø



21160-08  
 8 mm ø



21160-10  
 10 mm ø



21160-12  
 12 mm ø



21160-14  
 14 mm ø

Watteträger, Spatel  
Cotton Applicators, Spatulas  
Porta-algodones, Espátulas  
Portacotone, Spatole



FARRELL

4 3/4"	21270-12	12,0 cm
5 1/2"	21270-14	14,0 cm
6 1/2"	21270-16	16,5 cm
7"	21270-18	18,0 cm
9"	21270-23	23,0 cm



FARRELL

4 3/4"	21272-12	12,0 cm
5 1/2"	21272-14	14,0 cm
6 1/2"	21272-16	16,5 cm
7"	21272-18	18,0 cm
9"	21272-23	23,0 cm



1,5

REDA

4 3/4"	21290-12	12,0 cm
5 1/2"	21290-14	14,0 cm
6 1/4"	21290-16	16,0 cm
7"	21290-18	18,0 cm



1,5

REDA

4 3/4"	21292-12	12,0 cm
5 1/2"	21292-14	14,0 cm
6 1/4"	21292-16	16,0 cm
7"	21292-18	18,0 cm

Spatel  
Plaster spatula  
Espátula  
Spatole



21190-14  
14,5 cm, 5 3/4"



UCKERMANN  
21310-15  
15 cm, 6"

ø 3 mm



JOBSON-HORNE  
21320-12 12 cm, 4 3/4"  
21320-18 18 cm, 7"



TOBOLD  
21331-25  
25 cm, 10"

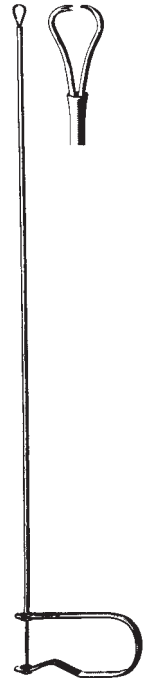

21340-45  
45 cm, 17 3/4"

Trokare  
Trocars  
Trócares  
Trequarti

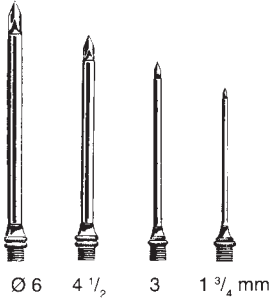

UNIVERSAL  
23104-00  
compl.



STANDARD (Nelson)

23110-30	3,0 mm ø
23110-35	3,5 mm ø
23110-40	4,0 mm ø
23110-45	4,5 mm ø
23110-50	5,0 mm ø
23110-55	5,5 mm ø
23110-60	6,0 mm ø

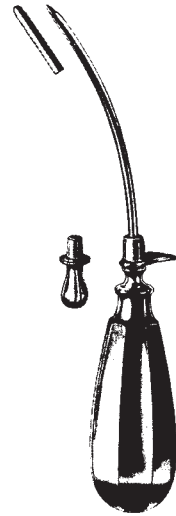

PIERCE

23123-30	3,0 mm Ø
23123-40	4,0 mm Ø
23123-50	5,0 mm Ø



DOUGLAS  
23125-11    3 mm Ø

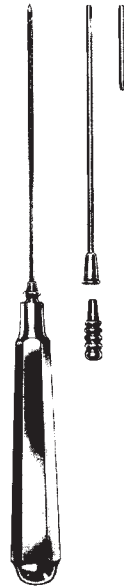

LICHTWITZ  
23128-19    1,75 mm Ø

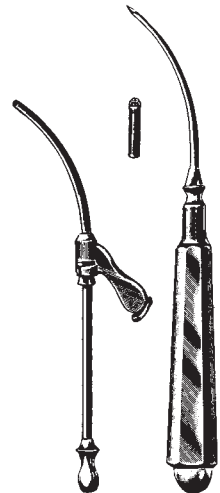

COAKLEY  
23140-02    2,25 mm Ø



Trokare  
Trocars  
Trócares  
Trequarti

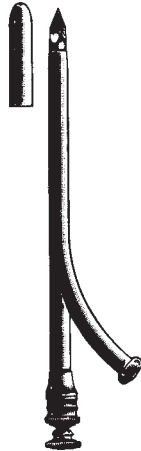

Charr./	
F.G.	OCHSNER
10	23150-10
12	23150-12
14	23150-14
16	23150-16
18	23150-18
20	23150-20



Charr./		
F.G.	NELSON	ø
25	23170-25	7,5 mm
30	23170-30	9,0 mm
33	23170-33	10,5 mm
35	23170-35	12,0 mm



SINOSKOPIE-TROKAR  
universal  
8,5 cm, 3.4"

23180-27 f. Optik mit Ø 2,7 mm  
23180-40 f. Optik mit Ø 4,0 mm



SINOSKOPIE-TROKAR  
abgeschrägt/oblique beak  
8,5 cm, 3.4"

23181-40 f. Optik mit Ø 4,0 mm

Biopsiekanülen  
 Biopsy Needles  
 Aguja para biopsia  
 Aghi per biopsia

Nadelführer  
 Pudendus  
 Anesthésie  
 anestesia



IOWA  
 23210-00  
 compl.



VERRES  
 23250-20 2,00x100 mm  
 23250-40 2,00x140 mm

Pneumoperitoneum  
 Pneumoperitoneum  
 Neumoperitoneo  
 Pneumoperitoneo



MENGHINI  
 23302-01 1,0x 35 mm  
 23302-02 1,0x 70 mm  
 23302-03 1,2x 70 mm  
 23302-04 1,2x100 mm  
 23302-05 1,4x 70 mm  
 23302-06 1,4x100 mm  
 23302-07 1,6x 70 mm  
 23302-08 1,8x100 mm



MENGHINI  
 23310-14 1,4x168 mm  
 23310-18 1,8x168 mm

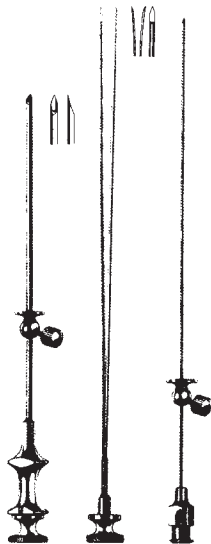

FRANKLIN-SILVERMANN  
 23330-20 2,0x105 1,5x155  
 23330-14 2,0x130 1,5x180  
 compl.

Biopsienadel  
 Biopsy needle  
 Aguja para biopsia  
 Aghi per biopsia

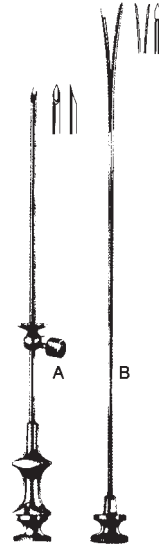

Spaltnadel  
 Bifurcated  
 Aguja bifurcada  
 Aghi biforcuto

FRANKLIN-SILVERMANN  
 A ø mm B ø mm A+B  
 23351-20 2,0x100 23352-15 1,5x150 23350-20  
 23351-30 2,5x145 23352-20 2,0x195 23350-30

Führungsnadeln  
 Guide needles  
 Aguja de Guía  
 Ago guida

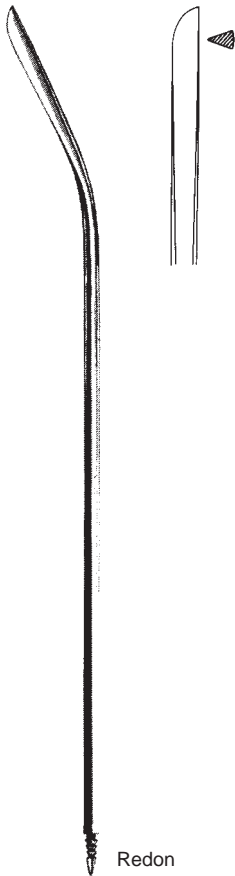

Redon

23195-08 - 23195-18

Führungsnadel, gerade  
 Guide Needle, straight  
 Aguja de guía, recta  
 Ago guida, retta

Charr./Fr.  
 8 23195-08  
 10 23195-10  
 12 23195-12  
 14 23195-14  
 16 23195-16  
 18 23195-18



Redon

23197-08 - 23197-18

Führungsnadel, gebogen  
 Guide Needle, curved  
 Aguja de guía, curva  
 Ago guida, curva

Charr./Fr.  
 8 23197-08  
 10 23197-10  
 12 23197-12  
 14 23197-14  
 16 23197-16  
 18 23197-18

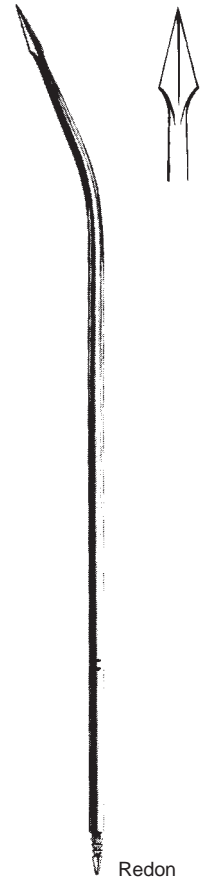

Redon

23198-08 - 23198-18

Führungsnadel, Lanzettspitze  
 Guide Needle, with lancet tip  
 Aguja de guía, con punta lanceolar  
 Ago guida, con punta lanceolata

Charr./Fr.  
 8 23198-08  
 10 23198-10  
 12 23198-12  
 14 23198-14  
 16 23198-16  
 18 23198-18

Nadelhalter  
Needle Holders  
Porta-agujas  
Port'aghi

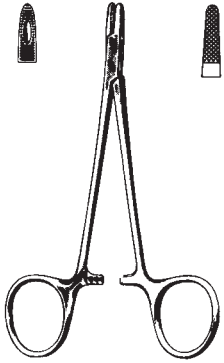

DERF  
25110-12  
12 cm, 4 3/4"  
**25114-12 TC**  
12 cm, 4 3/4"

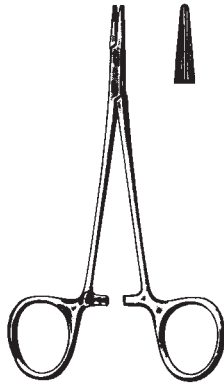

DERF  
25120-12  
12,5 cm, 5"



COLLIER  
25122-12  
12,5 cm, 5"

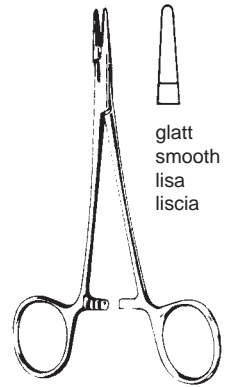

glatt  
smooth  
lisa  
liscia

WEBSTER  
25128-13  
13 cm, 5 1/8"  
**25129-13 TC**  
13 cm, 5 1/8"

BABY-WEBSTER  
25136-11  
11 cm, 4 3/8"  
**25137-11 TC**  
11 cm, 4 3/8"

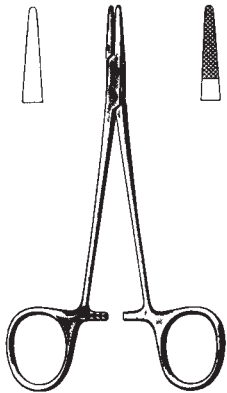

HALSEY  
25130-13    25140-13  
**25134-13 TC**    **25144-13 TC**  
13 cm, 5 1/8"

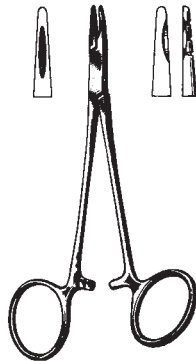

NEIVERT  
25146-13  
13 cm, 5 1/8"

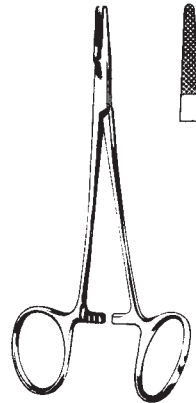

NEIVERT  
**25148-13 TC**  
13 cm, 5 1/8"



BAUMGARTNER  
25150-12    **25154-12 TC**  
12,5 cm, 5"  
25150-14    **25154-14 TC**  
14,0 cm, 5 1/2"

Nadelhalter  
Needle Holders  
Porta-agujas  
Port'aghi

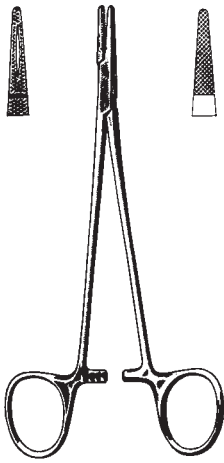

CRILE-WOOD

25160-15	15 cm, 6"	25164-15 TC
25160-18	18 cm, 7"	25164-18 TC
25160-20	20 cm, 8"	25164-20 TC
25160-23	23 cm, 9"	25164-23 TC



CRILE-MURRAY

25170-15	25174-15 TC
	15 cm, 6"

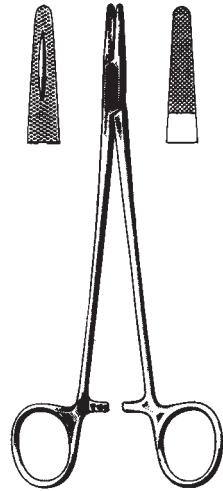

MAYO-HEGAR

25180-12	12 cm, 4 3/4"	25184-12 TC
25180-14	14 cm, 5 1/2"	25184-14 TC
25180-16	16 cm, 6 1/4"	25184-16 TC
25180-18	18 cm, 7"	25184-18 TC
25180-20	20 cm, 8"	25184-20 TC
25180-24	24 cm, 9 1/2"	25184-24 TC
25180-26	26 cm, 10 1/4"	25184-26 TC
25180-30	30 cm, 11 3/4"	25184-30 TC

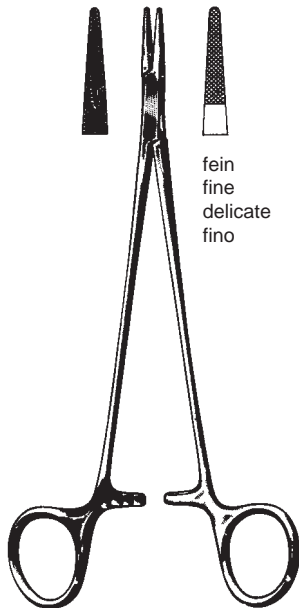

fein  
fine  
delicate  
fino

MAYO-HEGAR

25190-16	16 cm, 6 1/4"	25194-16 TC
25190-18	18 cm, 7"	25194-18 TC
25190-20	20 cm, 8"	25194-20 TC

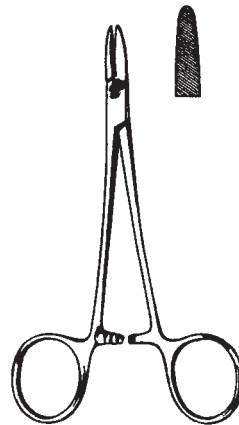

BROWN

25196-13	13 cm, 5 1/8"
25196-18	18 cm, 7"

Nadelhalter  
Needle Holders  
Porta-agujas  
Port'aghi



DE BAKEY

25214-16 TC	16 cm, 6 1/4"
25214-18 TC	18 cm, 7"
25214-20 TC	20 cm, 8"
25214-23 TC	23 cm, 9"
25214-26 TC	26 cm, 10 1/4"
25214-31 TC	31 cm, 12 1/4"



RYDER 1 mm

25224-13 TC	13 cm, 5 1/8"
25224-15 TC	15 cm, 6"
25224-18 TC	18 cm, 7"
25224-20 TC	20 cm, 8"
25224-23 TC	23 cm, 9"
25224-26 TC	26 cm, 10 1/4"

RYDER 2 mm

25225-13 TC	
25225-15 TC	
25225-18 TC	
25225-20 TC	
25225-23 TC	
25225-26 TC	

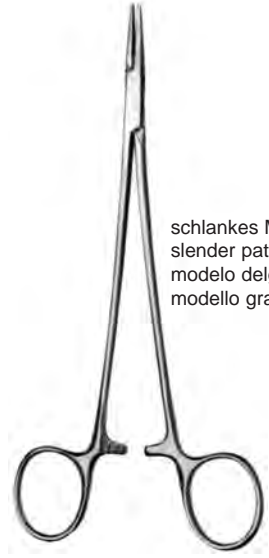

schlankes Modell  
slender pattern  
modelo delgado  
modello gracile

MICROVASCULAR

25230-18 TC	18 cm, 7"
25230-20 TC	20 cm, 8"
25230-23 TC	23 cm, 9"



HEANEY

25241-21	21 cm, 8 1/4"
25241-26	26 cm, 10 1/4"
25245-21 TC	21 cm, 8 1/4"
25245-26 TC	26 cm, 10 1/4"

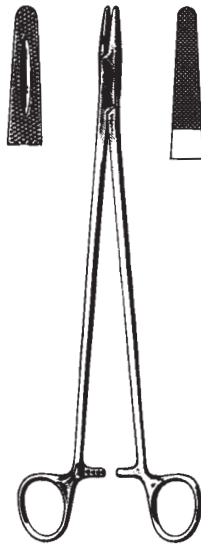

MASSON

25250-27	27 cm, 10 1/2"
25254-27 TC	27 cm, 10 1/2"



WANGENSTEEN

25260-27	27 cm, 10 1/2"
25264-27 TC	27 cm, 10 1/2"

Nadelhalter  
Needle Holders  
Porta-agujas  
Port'aghi

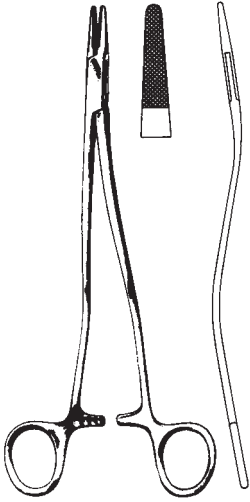

BOZEMANN

25285-20 TC 20 cm, 8"  
25285-24 TC 24 cm, 9 1/2"  
25285-26 TC 26 cm, 10 1/4"

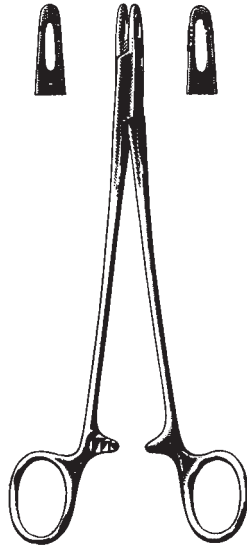

METZENBAUM

25290-18  
18 cm, 7"



ADSON

25292-18  
18 cm, 7"

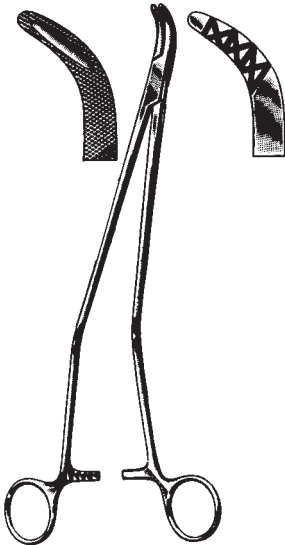

JOHNSON

25293-27  
27 cm, 10 1/2"



FINOCHIETTO

25311-20 20 cm, 8" 25315-20 TC  
25311-27 27 cm, 10 1/2" 25315-27 TC



SAROT

25324-18 TC 18 cm, 7"  
25324-26 TC 26 cm, 10 1/4"

Nadelhalter  
Needle Holders  
Porta-agujas  
Port'aghi

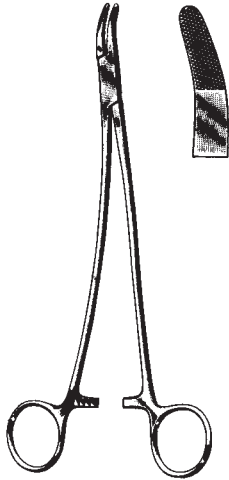

STRATTE

25330-21 21 cm, 8 1/4"  
25330-23 23 cm, 9" **25334-23 TC**

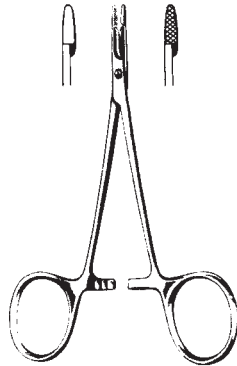

BABY-OLSEN-HEGAR

25405-12 25406-12  
**25408-12 TC 25407-12 TC**  
11,5 cm, 4 1/2"

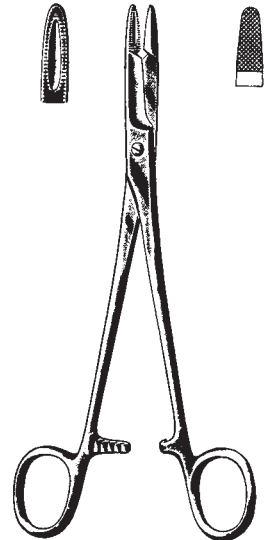

OLSEN-HEGAR

25410-14 14 cm, 5 1/2" **25414-14 TC**  
25410-17 17 cm, 6 3/4" **25414-17 TC**  
18 cm, 7" **25414-18 TC**



MATHIEU-OLSEN

**25415-14 TC** 14 cm, 5 1/2"  
**25415-17 TC** 17 cm, 6 3/4"  
**25415-20 TC** 20 cm, 8"

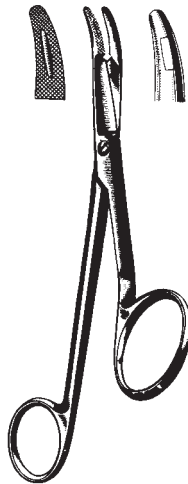

GILLIES

11 cm, 4 3/8" **25434-11 TC**  
13 cm, 5 1/8" **25434-13 TC**  
25430-16 16 cm, 6 1/4" **25434-16 TC**

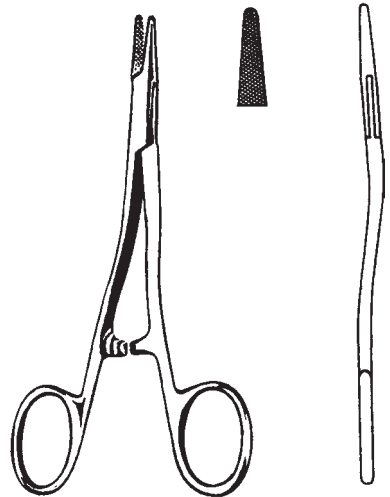

KILNER

25436-13 13 cm, 5 1/8"  
**25438-13 TC** 13 cm, 5 1/8"



Nadelhalter  
Needle Holders  
Porta-agujas  
Port'aghi

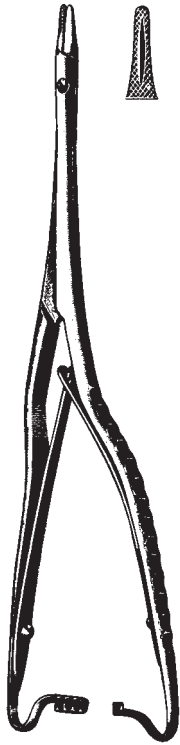

HOESEL

25446-25 25 cm, 10"  
25447-25 TC 25 cm, 10"

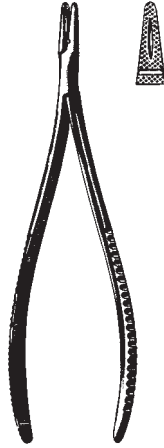

CRILE

25438-15 15 cm, 6"

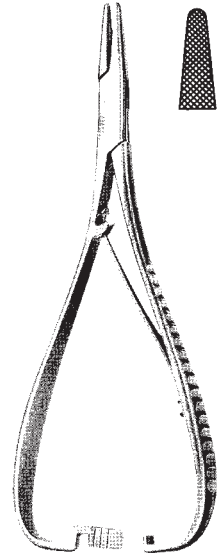

MATHIEU

25450-14 14 cm, 5 1/2" 25452-14 TC  
25450-17 17 cm, 6 3/4" 25452-17 TC  
25450-20 20 cm, 8" 25452-20 TC  
25450-24 24 cm, 9 1/2" 25452-24 TC

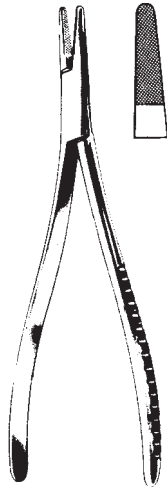

LANGENBECK

25460-18 TC 18 cm, 7"  
25460-20 TC 20 cm, 8"  
25460-23 TC 23 cm, 9"

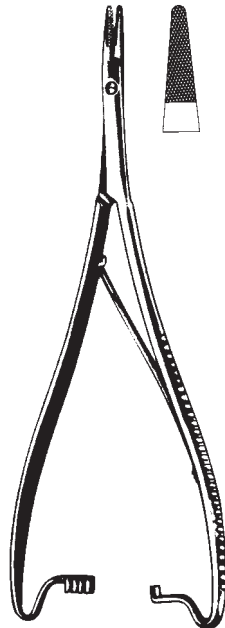

HOESEL

25465-20 TC 20 cm, 8"  
25465-25 TC 25 cm, 10"



LICHTENBERG

25466-17 17 cm, 6 3/4" 25467-17 TC  
25466-20 20 cm, 8" 25467-20 TC

Nadelhalter  
 Needle Holders  
 Porta-agujas  
 Port'aghi

Oftalmologie  
 Ophthalmology  
 Oftalmologia  
 Oftalmologia



STEVENS  
 25610-11  
 11 cm, 4 3/8"



STEVENS  
 25612-13 13 cm, 5 1/8"  
 25612-15 15 cm, 6"

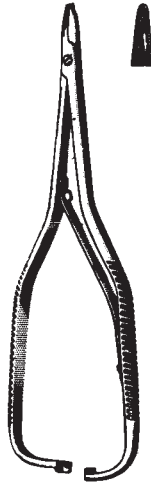

BOYNTON  
 25614-12  
 12 cm, 4 3/4"

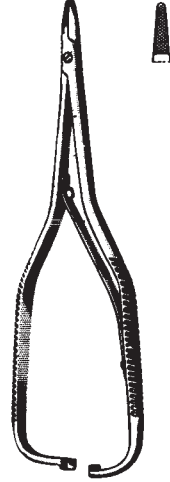

BOYNTON  
**25615-12 TC**  
 12 cm, 4 3/4"



ARRUGA  
 25620-16 - 25624-16  
 16 cm, 6 1/4"

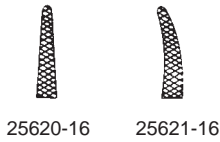

25620-16 25621-16

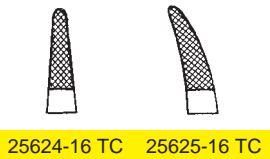

**25624-16 TC 25625-16 TC**

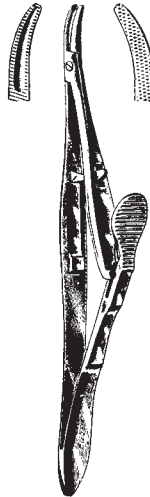

KALT-ARRUGA  
 25627-14  
 14 cm, 5 1/2"

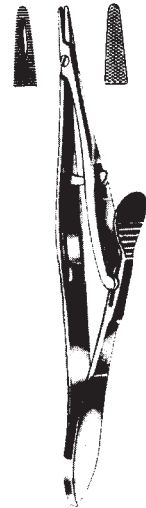

KALT  
 25628-14  
 14 cm, 5 1/2"

Nadelhalter  
Needle Holders  
Porta-agujas  
Port'aghi

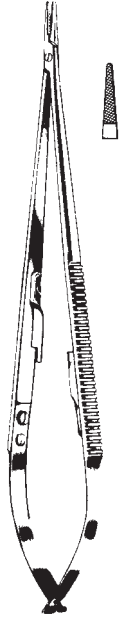

JACOBSEN  
25667-18 18 cm, 7"  
25668-18 TC 18 cm, 7"  
25667-21 21 cm, 8 1/4"  
25668-21 TC 21 cm, 8 1/4"

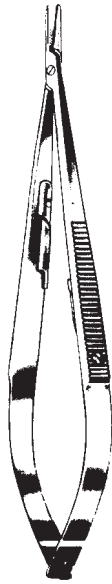

CASTROVIEJO  
14 cm, 5 1/2"



25670-14  
glatt  
smooth  
lisa  
liscia



25672-14  
gerieft  
serrated  
estriada  
zigrinato



25676-14 TC



25671-14  
glatt  
smooth  
lisa  
liscia



25673-14  
gerieft  
serrated  
estriada  
zigrinato



25677-14 TC



25678-09



CASTROVIEJO-MICRO  
9 cm, 3 1/2"



25679-09



CASTROVIEJO  
25680-13 13 cm, 5 1/8"  
25684-13 TC 13 cm, 5 1/8"

Mikro-Nadelhalter  
 Micro-Needle Holders  
 Micro-Porta-agujas  
 Micro-Port'aghi



CASTROVIEJO-STANDARD  
 25678-14 14 cm, 5 1/2"



CASTROVIEJO-STANDARD  
 25679-14 14 cm, 5 1/2"

25650-10 25651-10



BARRAQUER  
 10 cm, 4"

25656-10 25657-10



BARRAQUER-TROUTMAN  
 10 cm, 4"

Mikro-Nadelhalter  
Micro-Needle Holders  
Micro-Porta-agujas  
Micro-Port'aghi



25660-13

25661-13

BARRAQUER  
13 cm, 5 1/8"



25720-14  
25722-14 TC

25721-14  
25723-14 TC

BARRAQUER  
14 cm, 5 1/2"

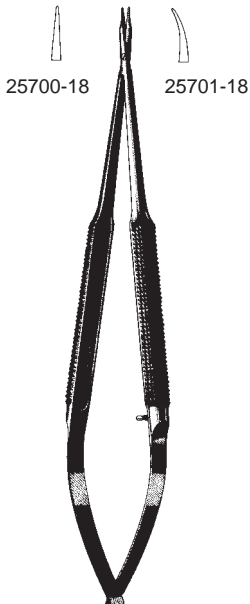

25700-18

25701-18

BARRAQUER  
18 cm, 7"

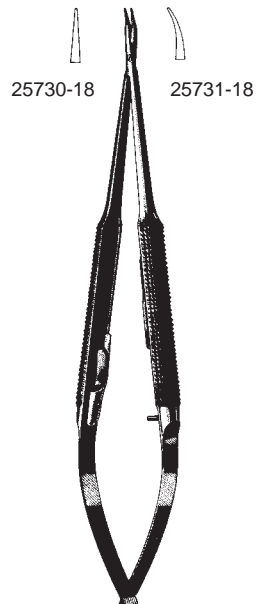

25730-18

25731-18

BARRAQUER  
18 cm, 7"

Unterbindungsnadeln  
 Ligature Needles  
 Aguja para ligaduras  
 Aghi per legature



biegsam  
 malleable  
 maleable  
 malleabile

27109-20

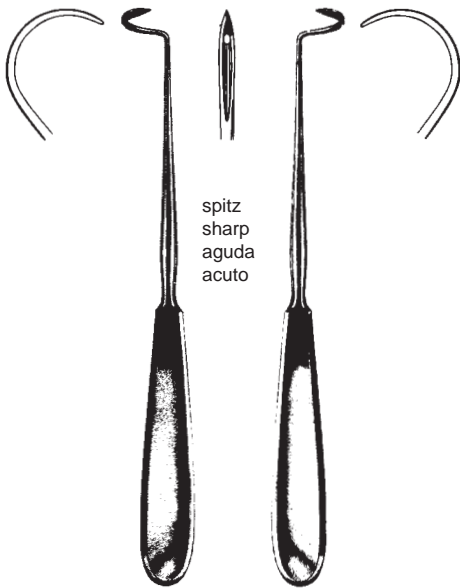

spitz  
 sharp  
 aguda  
 acuto

L	DESCHAMPS	R
27110-21	21 cm, 8 1/4"	27111-21
27110-24	24 cm, 9 1/2"	27111-24
27110-27	27 cm, 10 1/2"	27111-27

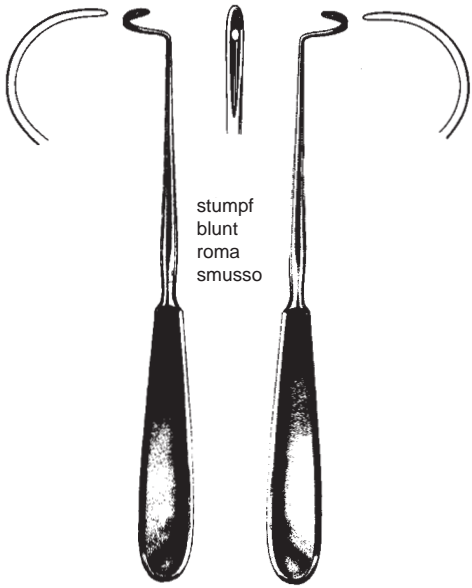

stumpf  
 blunt  
 roma  
 smusso

L	DESCHAMPS	R
27120-21	21 cm, 8 1/4"	27121-21
27120-24	24 cm, 9 1/2"	27121-24
27120-27	27 cm, 10 1/2"	27121-27

Unterbindungsnadeln  
 Ligature Needles  
 Aguja para ligaduras  
 Aghi per legature

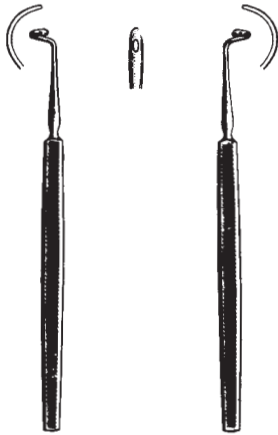

L KRONECKER R  
 27130-13 27131-13  
 13 cm, 5 1/8"

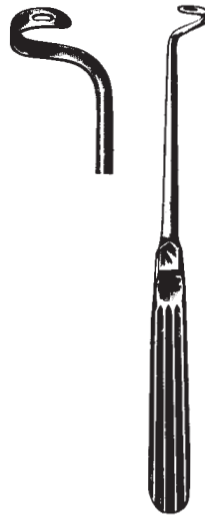

L NELSON R  
 27133-24 27135-24  
 24,5 cm, 9 3/4"



SCHMIEDEN-DICK  
 27134-32 32 cm, 12 3/4"

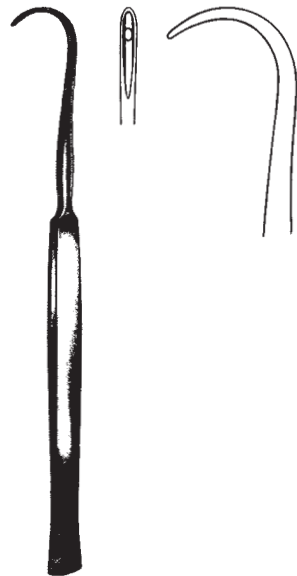

COOPER  
 27139-19 19 cm, 7 1/2"

Nahtinstrumente  
 Suturing Instruments  
 Instrumentos para suturas  
 Strumenti per suture

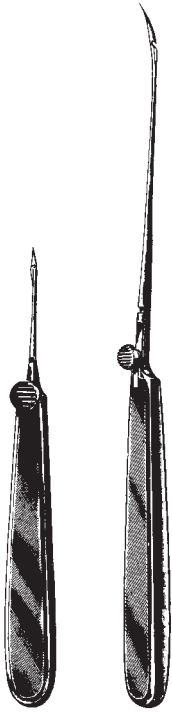

REVERDIN  
 27201-15 - 27204-21



Fig. 1  
 27201-15 15 cm, 6"  
 27201-19 19 cm, 7 1/2"  
 27201-21 21 cm, 8 1/4"



Fig. 2  
 27202-15 15 cm, 6"  
 27202-19 19 cm, 7 1/2"  
 27202-21 21 cm, 8 1/4"



Fig. 3  
 27203-15 15 cm, 6"  
 27203-19 19 cm, 7 1/2"  
 27203-21 21 cm, 8 1/4"



Fig. 4  
 27204-15 15 cm, 6"  
 27204-19 19 cm, 7 1/2"  
 27204-21 21 cm, 8 1/4"



YOUNG BOOMERANG  
 27240-00  
 25 cm, 10"



Fig. 1  
 27240-01



Fig. 2  
 27240-02

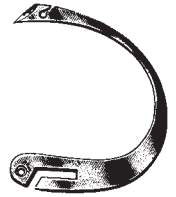
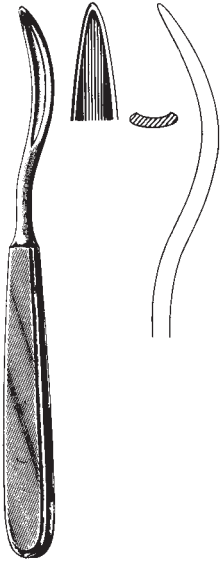

Fig. 3  
 27240-03



Führungshohlsonden  
Ligature Conductors  
Sondas conductoras  
Sonde conduttrici



SCHMIEDEN  
27271-19  
19 cm, 7 1/2"

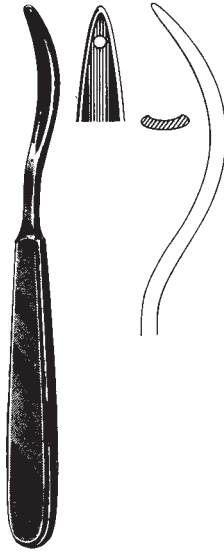

SCHMIEDEN-PAYR  
27273-19  
19 cm, 7 1/2"

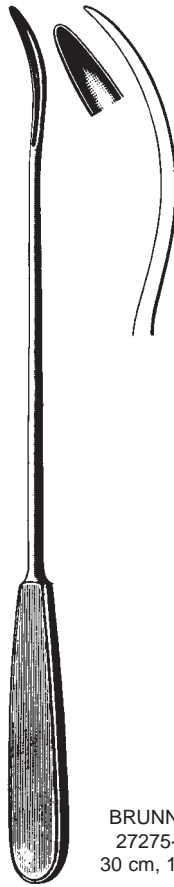

BRUNNER  
27275-30  
30 cm, 11 3/4"

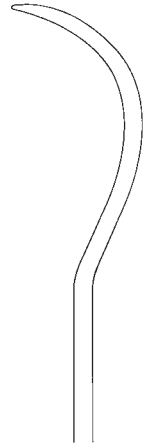

KIRSCHNER  
27277-25  
25,5 cm, 10"

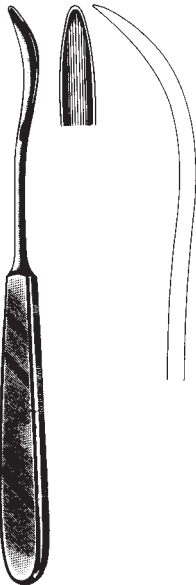

KOENIG  
27285-20  
20 cm, 8"



PAYR  
27288-22  
22 cm, 8 3/4"



PAYR  
27289-22  
22 cm, 8 3/4"

Plastik  
plastic  
plástico



BRUNNER  
27291-18 18 cm, 7"  
27291-27 27 cm, 10 1/2"



VIENNA  
27297-23  
23,5 cm, 9 1/4"



REDA  
27298-23  
23 cm, 9"

Chirurgische Nadeln  
Suturing Needles  
Agujas para suturas  
Aghi per suture

Pack à 1 Dutzend  
in packages of 1 dozen  
en sobres de 1 docena  
confezione 1 dozzina

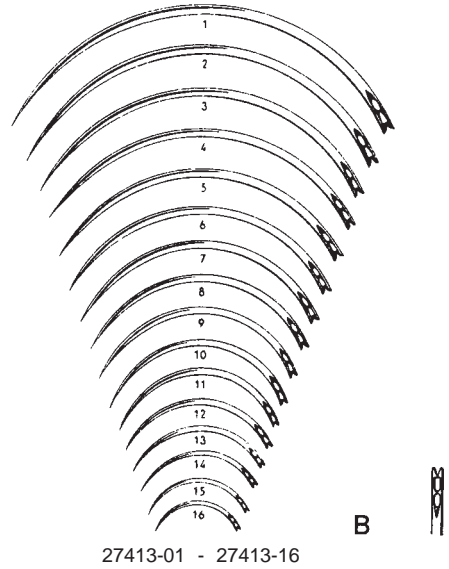
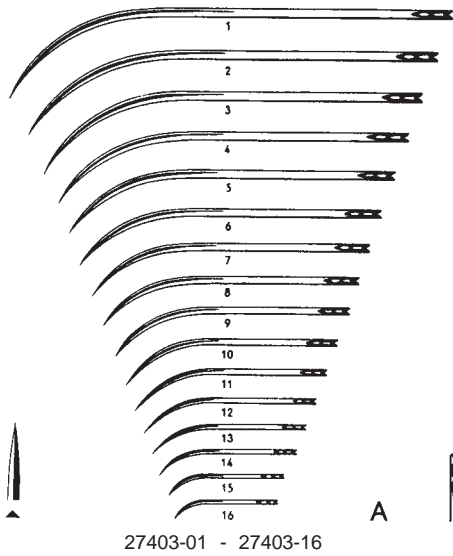
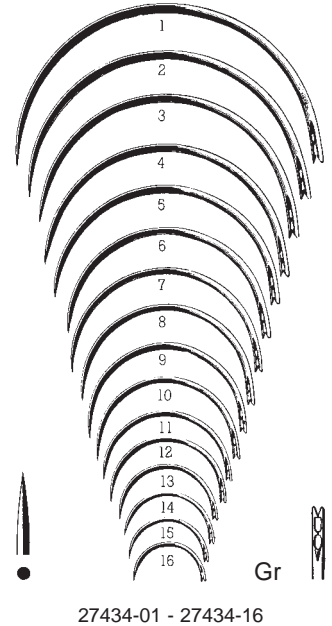
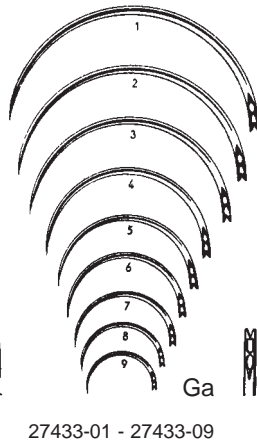
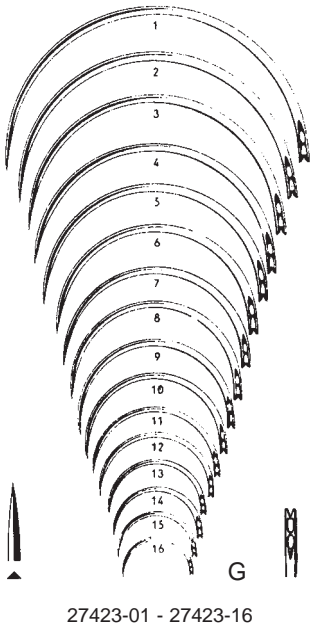
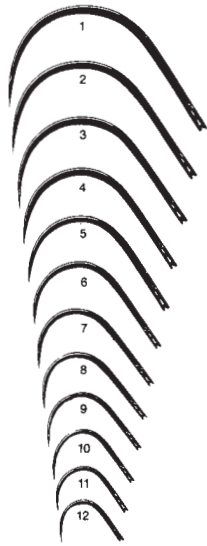

Fig. 1 2 3 4 5 6 7 8 9 10 11 12 13 14 15 16  
 A 27403-01 27403-02 27403-03 27403-04 27403-05 27403-06 27403-07 27403-08 27403-09 27403-10 27403-11 27403-12 27403-13 27403-14 27403-15 27403-16  
 B 27413-01 27413-02 27413-03 27413-04 27413-05 27413-06 27413-07 27413-08 27413-09 27413-10 27413-11 27413-12 27413-13 27413-14 27413-15 27413-16  
 G 27423-01 27423-02 27423-03 27423-04 27423-05 27423-06 27423-07 27423-08 27423-09  
 Ga 27433-01 27433-02 27433-03 27433-04 27433-05 27433-06 27433-07 27433-08 27433-09 27433-10 27433-11 27433-12 27433-13 27433-14 27433-15 27433-16  
 Gr 27434-01 27434-02 27434-03 27434-04 27434-05 27434-06 27434-07 27434-08 27434-09 27434-10 27434-11 27434-12 27434-13 27434-14 27434-15 27434-16

Alle Nadeln mit Öhr  
all the needles with spring eye  
todas las agujas con ojo a resorte  
tutti gli aghi con cruna aperta



Alle Nadeln mit Öhr  
 all the needles with spring eye  
 todas las agujas con ojo a resorte  
 tutti gli aghi con cruna aperta



27441-01 - 27441-12



Chirurgische Nadeln  
 Suturing Needles  
 Agujas para suturas  
 Aghi per suture

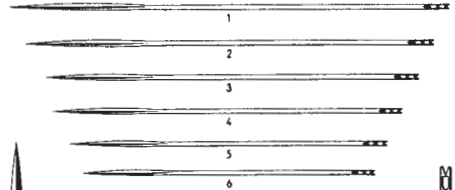

KEITH  
 27450-01 - 27450-06

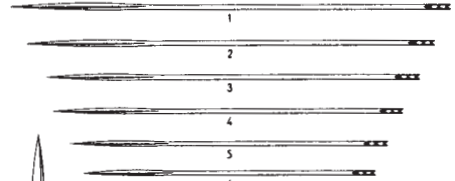

KEITH  
 27452-01 - 27452-06

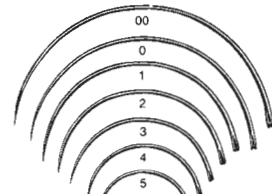

27465-20 - 27467-05 Pb

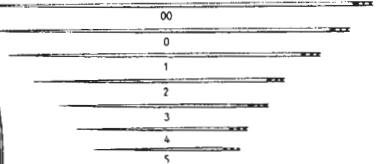

27475-20 - 27477-05 Pc

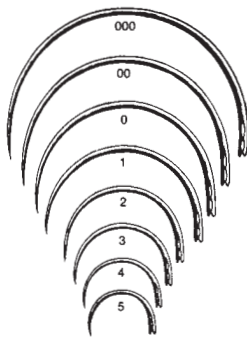

27443-30 - 27443-05

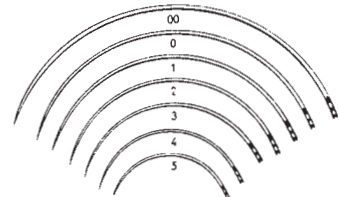

27485-20 - 27487-05 Pd



FIG.	000	00	0	1	2	3	4	5	6	7	8	9	10	11	12
KÖNIG				27441-01	27441-02	27441-03	27441-04	27441-05	27441-06	27441-07	27441-08	27441-09	27441-10	27441-11	27441-12
E	27443-30	27443-20	27443-10	27443-01	27443-02	27443-03	27443-04	27443-05							
KEITH				27450-01	27450-02	27450-03	27450-04	27450-05	27450-06						
KEITH				27452-01	27452-02	27452-03	27452-04	27452-05	27452-06						
Pb	27465-20	27465-10	27467-01	27467-02	27467-03	27467-04	27467-05								
Pc	27475-20	27475-10	27477-01	27477-02	27477-03	27477-04	27477-05								
Pd	27485-20	27485-10	27487-01	27487-02	27487-03	27487-04	27487-05								

Nahtinstrumente und Wundklammern  
 Clips and Instruments  
 Agrafes e instrumentos  
 Agrafes e strumenti



MICHEL  
 27610-12  
 12 cm, 4 3/4"



WACHENFELDT  
 27612-12  
 12,5 cm, 5"



WACHENFELDT  
 27614-12  
 12,5 cm, 5"



HEGENBARTH  
 27616-12  
 12,5 cm, 5"

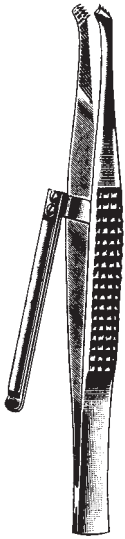

CHILDE  
 27620-18  
 18 cm, 7"



MICHEL  
 27630-12  
 12 cm, 4 3/4"

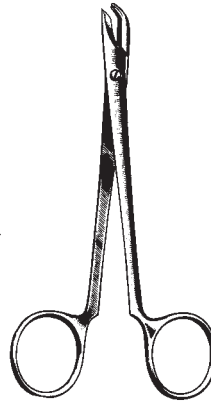

COLLIN  
 27640-13  
 13 cm, 5 1/8"

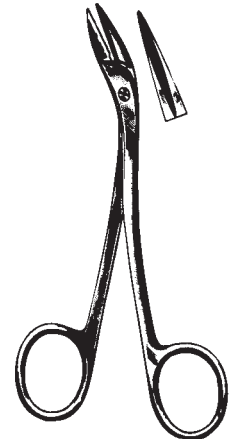

RICHTER-HEATH  
 27642-14  
 14 cm, 5 1/2"

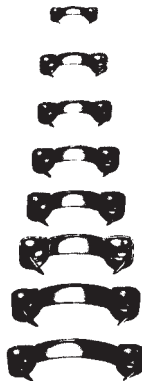

MICHEL

- MICHEL mm
- 27660-07 7,5x1,75
- 27660-11 11x2
- 27660-12 12x3
- 27660-14 14x3
- 27660-16 16x3
- 27660-18 18x3
- 27660-20 20x3
- 27660-22 22x3

Pack à 1000  
 box of 1000  
 paq x 1000  
 confezione x 1000

Taschenbestecke  
Pocket, Suturing Kits  
Estuche de bolsillo y de sutura  
Astucci tascabili e per sutura

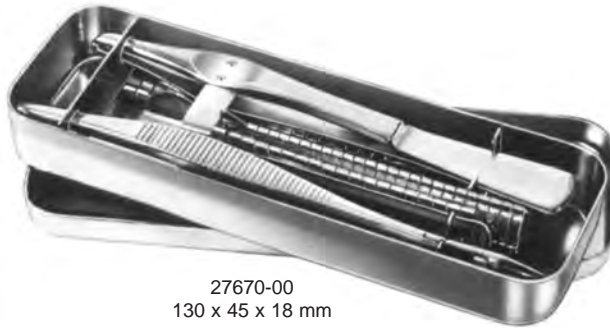

27670-00  
130 x 45 x 18 mm

Wundnahtbesteck in Metall-Etui,  
bestehend aus:  
Michel Wundklammerzängchen  
Wachenfeldt Faßpinzette  
50 Michel Wundklammern

Estuche para sutura, en caja de metal,  
compuesto de:  
Pinza para agrafes de Michel  
Pinza para juntar los bordes de la herida,  
de Wachenfeldt, con porta-agrafas  
50 Agrafes (Grapas) de Michel

Suture Clip set in metal case,  
consisting of:  
Suture Clip Forceps Michel  
Approximation Forceps, Wachenfeldt,  
with clip rack  
50 suture clips Michel

Set di clip per suture in astuccio di metallo  
composto da:  
Pinza di Michel per clip  
Pinza Wachenfeldt con fermagli per sutura  
50 Agrafes di Michel

Taschenbestecke  
 Pocket, Suturing Kits  
 Estuche de bolsillo y de sutura  
 Astucci tascabili e per sutura



STANDARD

27680-00  
 165 x 90 x 28 mm

Komplett in Metalletui und Plastiktasche mit 2 heraus-  
 nehbaren gelochten Einlagen mit Stegen für Instrumente

Bestehend aus:

- 1 Mathieu Nadelhalter 14 cm (5<sup>1/2</sup>"
- 1 Nähseide in Alkohol
- 6 Nähnadeln sortiert
- 1 Nadeldose gelocht 65 x 42 cm
- 1 Michel Wundklammerzange
- 20 Wundklammern auf Halter
- 1 Skalpellgriff mit Klinge
- 3 Klängen auswechselbar
- 1 Schere st/sp. 13 cm (5") gerade
- 1 anat. Pinzette 11,5 cm (4<sup>1/2</sup>"
- 1 Hakenpinzette 1 x 2 Z. 12 cm (4<sup>3/4</sup>"
- 1 Hunter Splitterpinzette 10,5 cm (4<sup>1/4</sup>"
- 1 Kocher Arterienklemme 13 cm (5")
- 1 Myrtenblattsonde 13 cm (5")

Complete in metal case with plastic pouch and  
 2 removable perforated trays for instruments

Contents:

- 1 Mathieu Needle Holder, 14 cm (5<sup>1/2</sup>"
- 1 Flacon with sterilized silk in alcohol
- 6 Suture Needles, assorted
- 1 Needle Case, 25.6" x 16.5", perforated
- 1 Michel Suture Clip Forceps
- 20 Michel Suture Clips with Clip Holder
- 1 Scalpel Handle with Blade
- 3 Scalpel Blades, interchangeable
- 1 Scissors, straight, blunt/sharp, 13 cm (5")
- 1 Dressing Forceps, 11,5 cm (4<sup>1/2</sup>"
- 1 Tissue Forceps, 12 cm (4<sup>3/4</sup>"
- 1 Hunter Splinter Forceps, 10,5 cm (4<sup>1/4</sup>"
- 1 Kocher Artery Forceps, straight, 13 cm (5"), S
- 1 Probe with myrtle leaf, 13 cm (5")

Completo en caja de metal con bolsa de plástico y 2  
 bandejas perforadas para los instrumentos

Contenido:

- 1 Porta-aguja de Mathieu, 14 cm (5<sup>1/2</sup>"
- 1 Frasco con seda esterilizada para sutura, en alcohol
- 6 Agujas de sutura surtidas
- 1 Cajita para agujas, 65 x 42 mm, perforada
- 1 Pinza para agrafes de Michel
- 20 Agrafes de Michel, en su porta-agrafes
- 1 Mango de bisturi, con hoja intercambiable
- 3 Hojas intercambiables surtidas
- 1 Tijera, recta, roma/aguda, 13 cm (5")
- 1 Pinza de disección, 11,5 cm (4<sup>1/2</sup>"
- 1 Pinza de disección, con 1 x 2 dientes, 12 cm (4<sup>3/4</sup>"
- 1 Pinza para espinas de Hunter, 10,5 cm (4<sup>1/4</sup>"
- 1 Pinza hemostática de Kocher, 13 cm (5"), S.
- 1 Estilete abotonado, multiforme, 13 cm (5")

Astuccio tascabile con due  
 supporti estraibili

Contenente:

- 1 Port aghi di Mathieu 14 cm (5<sup>1/2</sup>"
- 1 Set per suture in flacone di vetro
- 6 aghi per sutura assortiti
- 1 scatola per aghi 65 x 24 perforata
- 1 pinza per sutura di Michel
- 20 Agrafe Michel ed porta agrafe
- 1 Manico da bisturi per lama intercambiabile
- 3 lame da bisturi intercambiabili
- 1 forbici rette alterne 13 cm (5")
- 1 pinze da dissezione
- 1 pinze da dissezione 1 x 2 denti
- 1 pinze di Hunter per schegge 10,5 cm (4<sup>1/4</sup>"
- 1 pinze emostatiche di Kocher 13 cm (5")
- 1 specillo bottonuto 13 cm (5")

Sterilisierzangen, Abfallzange, Sterilisierklammern  
 Sterilization Instruments, Waste Forceps, Safety pins  
 Instrumentos para la esterilización, Pinza para desechos, Cadres de estérilizacion,  
 Pinze per la sterilizzazione, Pinza per rifiuti, Spilloni p. sterilizzazione



DAVIS  
 29102-16 16 cm, 6 1/4"  
 29102-20 20 cm, 8"  
 29102-24 24 cm, 9 1/2"

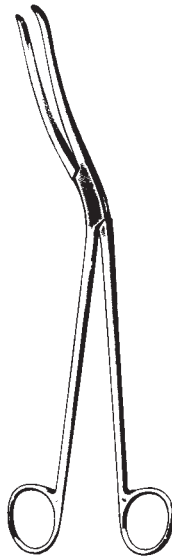

CHEATLE  
 29110-27  
 27 cm, 10 1/2"

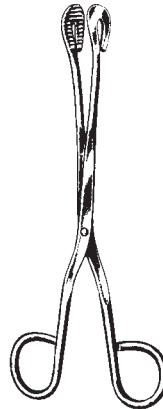

UNIVERSAL  
 29120-20 20 cm, 8" 29121-20  
 29120-28 28 cm, 11" 29121-28

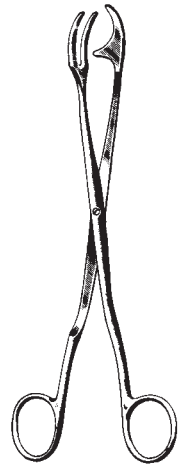

ROGGE  
 29130-23  
 23 cm, 9"



29140-20 20 cm, 8"  
 29140-30 30 cm, 11 3/4"



SAUERBRUCH  
 29145-55  
 55 cm, 21.7"



BUNT  
 29150-12 12 cm, 4 3/4"

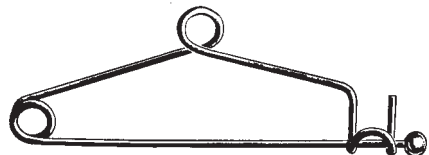

MAYO  
 29152-14 14 cm, 5 1/2"

Gipsscheren  
 Plaster of Paris Shears  
 Cizallas para vendajes enyesados  
 Cesioie per gessi

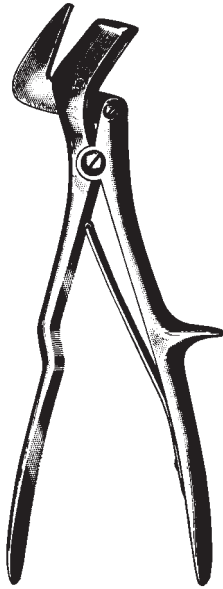

STILLE  
 31101-24 24 cm, 9 1/2"



STILLE  
 31103-23 23 cm, 9"  
 31103-26 26 cm, 10 1/4"  
 31103-37 37 cm, 14 1/2"



Gipsmesser  
 plaster knife  
 cuchillo para vendajes enyesados  
 coltello da gesso

WIGMORE  
 31120-19 19 cm, 7 1/2"

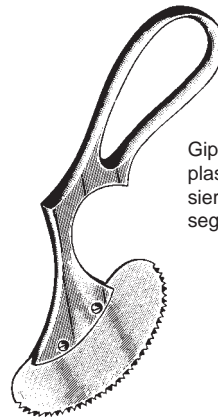

Gipssäge  
 plaster saw  
 sierra para vendajes enyesados  
 sega da gesso

ENGEL  
 31130-14  
 verchromt



Oscillierende Gipssäge  
 Oscillating Plaster Saw  
 Sierra oscilante p. vendajes enyesados  
 Seg a oscillante per gessi

Elektrische Gipssäge  
 Electric Plaster Cast Cutter  
 Sierra eléctrica para yesos  
 Seg a elettrica per gessi



31210-21 110 Volt, compl. of Art.-Nr. 31212-02/31210-50/31210-65  
 31210-22 230 Volt, compl. of Art.-Nr. 31212-02/31210-50/31210-65

Geräuschpegel min. 63 max. 69 DB  
 Noise level machine only: Min. 63 Max. 69 db/(A)  
 Nivel de ruido del aparato sólo 63 dB (mín.), 69 dB/(A)  
 Livello acustico dello strumento solo: min. 63 max. 69 db/(A)

EN 60601-1, EN 60601-1-2, IEC 60601-1, IEC 60601-1-2

31212-02  
 Schlüsselpaar  
 pair of screw driver  
 par le Llave  
 paio di chiavi

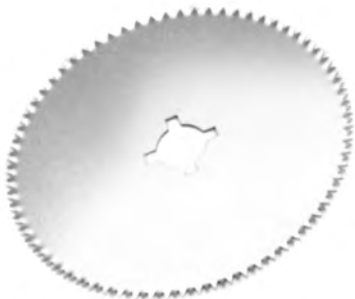

31210-50 50 mm (2.0") Ø weich \*  
 31210-65 65 mm (2.6") Ø weich \*  
 31211-50 50 mm (2.0") Ø hart \*  
 31211-65 65 mm (2.6") Ø hart \*

\* Ersatz-Sägeblätter, spezialgehärtet (F. Fiberglas u. andere Hartverbände)  
 \* Spare saw blades, special hardness (for dressing of fiber glass for other hard dressing)  
 \* Hojas de repuesto, templadas especialmente (para vendajes de fibra de vidrio y otros vendajes duros)  
 \* Lame per seg a tempera speciale per bendaggi (in fibro di vetro ed altri bendaggi duri)

Oscillierende Gipssäge mit Staubabsauger  
Oscillating Plaster Saw with plaster vacuum  
Sierra oscillante con aspiraciòn  
Sega oscillante per gesso con aspirazione



31250-00

Autopsiesäge  
Autopsy saw  
Sierra para autopsia  
Sega per autopsia

Schnellspannfutter  
Quick-action chuck  
tuerca de fijación rapida  
Mandrino rapido



31201-11 110 Volt, ohne Zubehör / without accessory / sin accesorio / senza accessori  
31201-22 230 Volt, ohne Zubehör / without accessory / sin accesorio / senza accessori

Geräuschpegel min. 63 max. 69 DB  
Noise level machine only: Min. 63 Max. 69 db/(A)  
Nivel de ruido del aparato sólo 63 dB (mín.), 69 dB/(A)  
Livello acustico dello strumento solo: min. 63 max. 69 db/(A)

EN 60601-1, EN 60601-1-2, IEC 60601-1, IEC 60601-1-2

Zubehör zur Autopsiesäge  
Accessories for Autopsy saw  
Accesorio para la sierra de autopsia  
Accessori per sega per autopsia



### Segmentssäge

besteht aus:  
1 x 31204-01 Segment-Sägeblatt  
1 x 31201-39 Schaft 39 mm

### Segment saw

consisting of:  
1 x 31204-01 segment saw  
1 x 31201-39 arbor 39 mm

### Sierra para segmento

compuesto de:  
1 x 31204-01 hoja de sierra  
1 x 31201-39 vastago 39 mm

### Sega a segmento

composta da:  
1 x 31204-01 Lama a segmento  
1 x 31201-39 Asta 39 mm



### Tiefensäge

besteht aus:  
1 x 31205-20 Tiefen-Sägeblatt, 20 mm  
1 x 31201-39 Schaft 39 mm

### Deep cutting saw

consisting of:  
1 x 31205-20 deep cutting saw, 20 mm  
1 x 31201-39 arbor 39 mm

### Sierra de profundidad

compuesto de:  
1 x 31205-20 hoja de sierra, 20 mm  
1 x 31201-39 vastago 39 mm

### Sega a taglio di profondità

composta da:  
1 x 31205-20 Lama a taglio di profondità, 20 mm  
1 x 31201-39 Asta 39 mm



### Tiefensäge schmal

besteht aus:  
1 x 31205-08 Tiefen-Sägeblatt, 8 mm  
1 x 31201-39 Schaft 39 mm

### Deep cutting saw narrow

consisting of:  
1 x 31205-08 deep cutting saw, 8 mm  
1 x 31201-39 arbor 39 mm

### Sierra de profundiad, estrecha

compuesto de:  
1 x 31205-08 hoja de sierra, 8 mm  
1 x 31201-39 vastago 39 mm

### Sega a taglio sottile di profondità

composta da:  
1 x 31205-08 Lama a taglio di profondità, 8 mm  
1 x 31201-39 Asta 39 mm



### Kreissäge ø 65 mm

mit exzentrischer Begrenzungsscheibe für differenzierte Schnitt-Tiefe von 4 bis 11 mm,  
besteht aus:

1 x 31210-65 Sägeblatt ø 65 mm  
1 x 31203-50 Begrenzungsscheibe  
1 x 31201-39 Schaft 39 mm

### Circular saw ø 65 mm

with eccentric disk to limit depth of cut from 4 - 11 mm

consisting of:  
1 x 31210-65 circular saw ø 65 mm  
1 x 31203-50 limiting disc  
1 x 31201-39 arbor 39 mm

### Sierra circular ø 65 mm

con disco de tope excentrico para diferentes cortes de profundidad de 4 mm hasta 11 mm  
compuesto de:

1 x 31210-65 hoja de sierra, ø 65 mm  
1 x 31203-50 disco de tope  
1 x 31201-39 vastago 39 mm

### Sega circolare diam. 65 mm

con disco di limitazione eccentrico per taglio differenziato dal 4 mm al 11 mm,

composta da:  
1 x 31210-65 Lama circolare, ø 65 mm  
1 x 31203-50 Disco eccentrico  
1 x 31201-39 Asta 39 mm

Zubehör zur Autopsiesäge  
Accessories for Autopsy saw  
Accesorio para la sierra de autopsia  
Accessori per sega per autopsia



31201-39  
Schaft, 39 mm lang  
arbor, 39 mm  
vástago, 39 mm de largo  
asta, lunghezza 39 mm



31201-58  
Schaft, 58 mm lang  
arbor, 58 mm  
vástago, 58 mm de largo  
asta, lunghezza 58 mm



31202-16  
Imbusschlüssel mit T-Griff zum Befestigen des Bohrfutters  
Alan key wit T-handle  
Llave hexagonal con mango de T para fijacion del taladro  
Chiave esagonale con manico a T per fissaggio del mandrino



31212-02  
Schlüsselpaar zum Auswechseln der Sägeblätter  
pair of screw driver  
par de llave para cambiar las hojas de sierra  
Paio di chiavi per cambio delle lame



Gipsspreizer, Gipsabreißzangen  
Plaster Cast Instruments  
Instrumentos para vendajes enyesados  
Allargagessi, Strappagessi

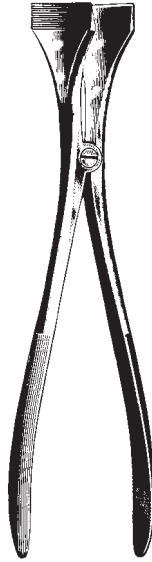

HENNIG  
31350-28 28 cm, 11"

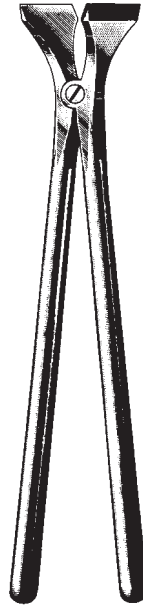

BEESON  
31360-30 30 cm, 11 3/4"

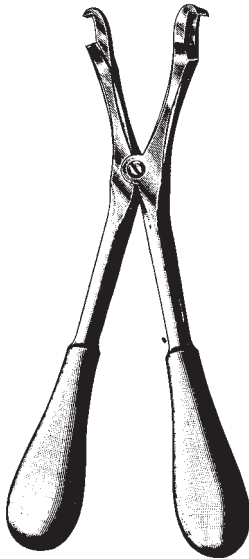

HAGLUND-STILLE  
31362-28 28 cm, 11"



REDA  
31366-23 23 cm, 9"

Gipsspreizer, Gipsmesser, Gipsabreißzangen  
Plaster Cast Instruments, Knives  
Instrumentos para vendajes enyesados, Cuchillos  
Allargagessi, Coltelli per Gessi, Strappagessi



HOPKINS  
31370-20  
20 cm, 8"



ESMARCH  
31380-18  
18 cm, 7"



REINER  
31390-18  
18 cm, 7"



WOLFF  
31395-18  
18 cm, 7"



WOLFF  
31397-24  
24 cm, 9 1/2"



Hohlmeißelzangen  
 Bone Rongeurs  
 Pinzas-gubias  
 Pinze sgorbie

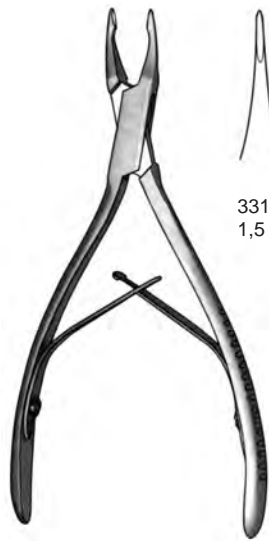

33100-01  
 1,5 x 5 mm

MICRO FRIEDMAN  
 33100-02 14 cm, 5 1/2"



33100-02  
 1,5 x 5 mm

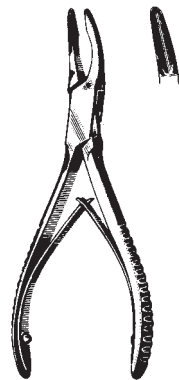

FRIEDMAN Mini  
 33101-12 12 cm, 4 3/4"

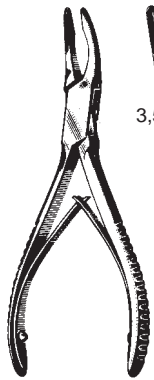

3,5 mm

FRIEDMAN  
 33101-14 14 cm, 5 1/2"

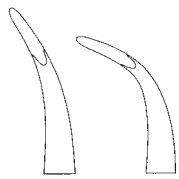

33102-01 2 mm  
 33102-02 2 mm

STELLBRINK  
 33102-02 17 cm, 6 3/4"

Hohlmeißelzangen  
Bone Rongeurs  
Pinzas-gubias  
Pinze sgorbie

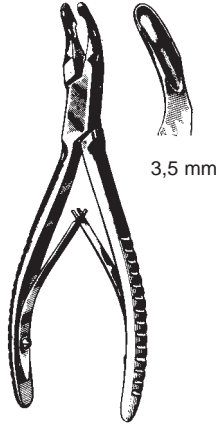

CLEVELAND  
33103-14 14 cm, 5 1/2"

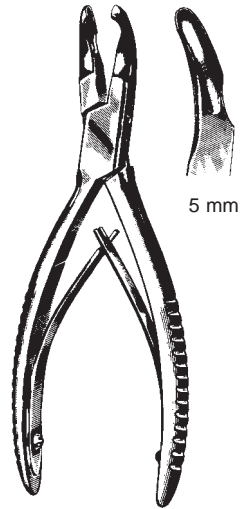

CLEVELAND  
33105-17 17 cm, 6 3/4"

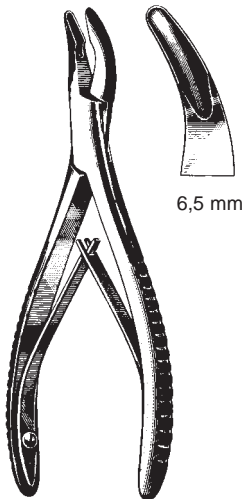

MEAD  
33107-16 16,5 cm, 6 1/2"

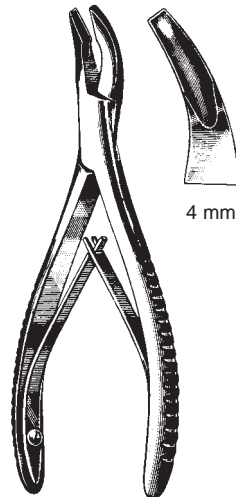

MEAD  
33109-16 16,5 cm, 6 1/2"

Hohlmeißelzangen  
 Bone Rongeurs  
 Pinzas-gubias  
 Pinze sgorbie

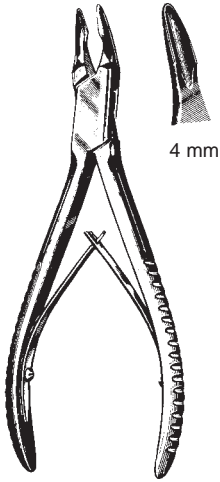

4 mm

BLUMENTHAL  
 33115-15  
 15,5 cm, 6"

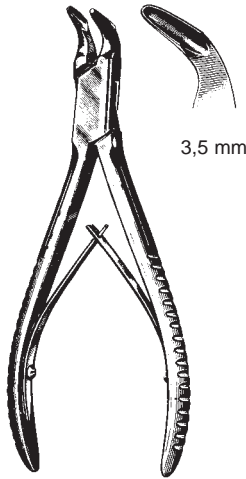

3,5 mm

BLUMENTHAL  
 33117-15  
 15,5 cm, 6"

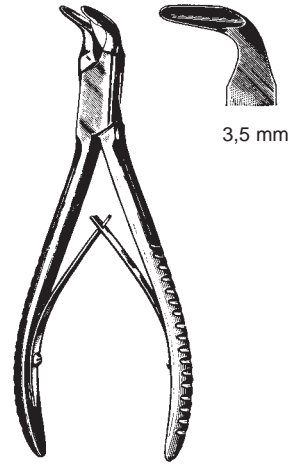

3,5 mm

BLUMENTHAL  
 33119-15  
 15,5 cm, 6"

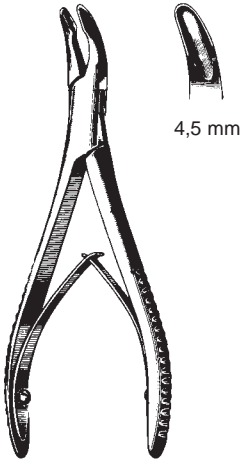

4,5 mm

LUER  
 33131-15  
 15 cm, 5.9"

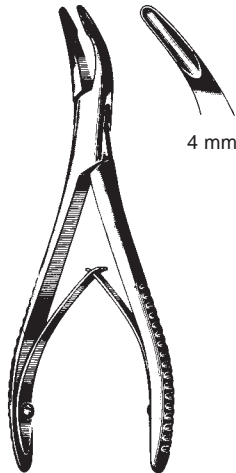

4 mm

LUER  
 33133-15  
 15 cm, 5.9"

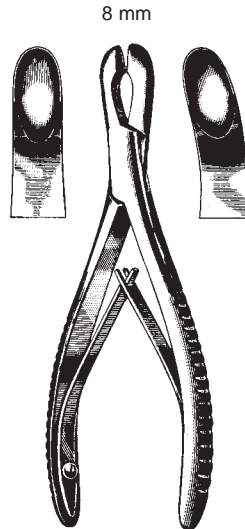

8 mm

LUER  
 33136-17 33137-17  
 17 cm, 6 3/4"

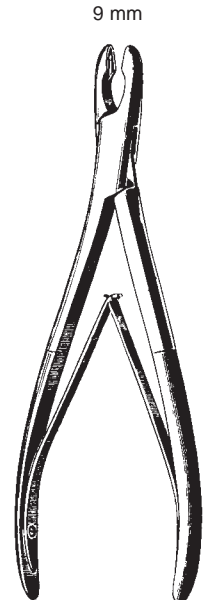

9 mm

ADSON  
 33142-20 33143-20  
 20 cm, 7.9"

Hohlmeißelzangen  
 Bone Rongeurs  
 Pinzas-gubias  
 Pinze sgorbie

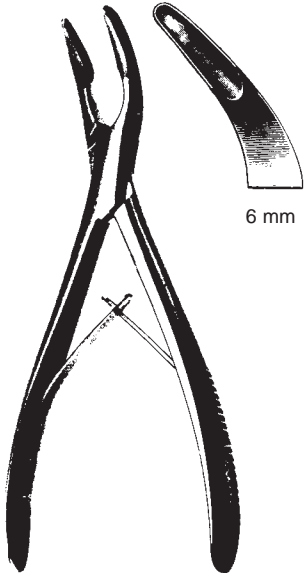

OLIVECRONA  
 33147-20  
 20 cm, 7.9"

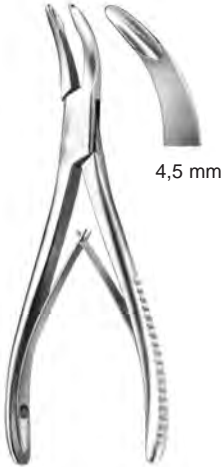

BANE-HARTMANN  
 33148-18  
 17,5 cm, 7"



LEMPERT  
 33150-16 33151-16  
 16 cm, 6 1/4"



JANSEN  
 33152-17 33153-17  
 17 cm, 6 3/4"



LEMPERT  
 33154-18 33155-18  
 18,5 cm, 7 1/2"



BEYER  
 33156-18  
 18 cm, 7"

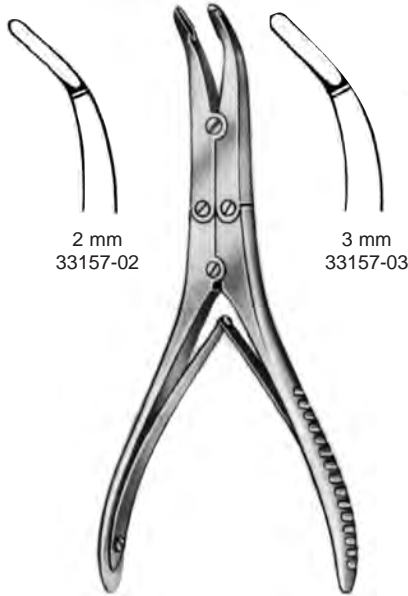

KLEINERT-KUTZ  
 33157-02 33157-03  
 15 cm, 6"

Hohlmeißelzangen  
 Bone Rongeurs  
 Pinzas-gubias  
 Pinze sgorbie

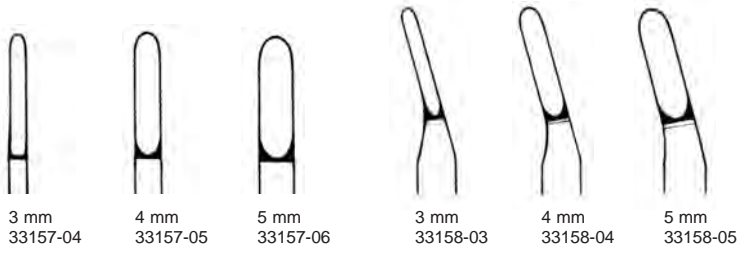

3 mm 33157-04    4 mm 33157-05    5 mm 33157-06  
 3 mm 33158-03    4 mm 33158-04    5 mm 33158-05

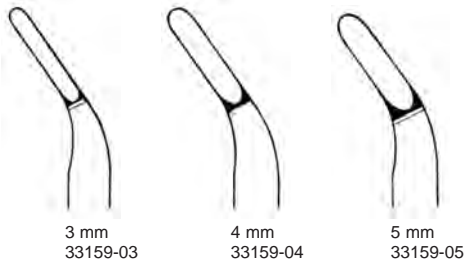

3 mm 33159-03    4 mm 33159-04    5 mm 33159-05



SMITH-PETERSEN  
 24 cm, 9 1/2"

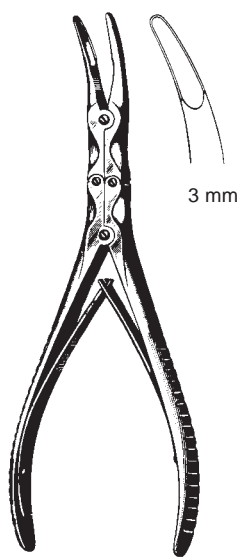

BEYER  
 33201-18  
 18 cm, 7"



MAYFIELD  
 33202-18  
 18 cm, 7"

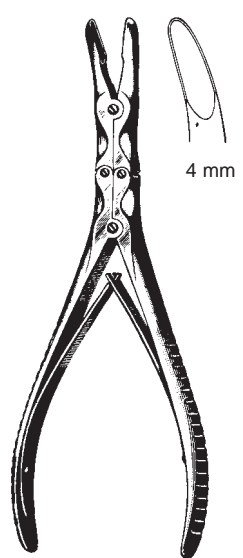

ZAUFAL-JANSEN  
 33205-18  
 18 cm, 7"

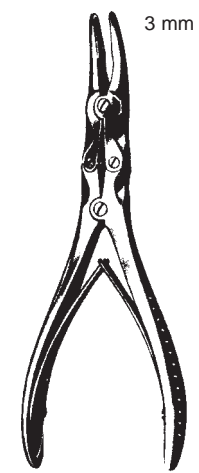

— BÖHLER —  
 33211-15 33213-15  
 15 cm, 6"

Hohlmeißelzangen  
 Bone Rongeurs  
 Pinzas-gubias  
 Pinze sgorbie

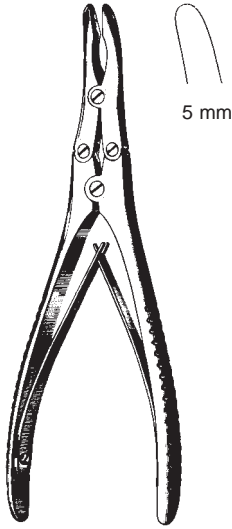

— RUSKIN —  
 33216-18 33217-18  
 18 cm, 7"

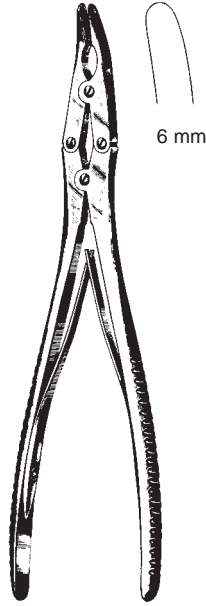

RUSKIN  
 33219-23 23 cm, 9"



MARQUARDT  
 33220-20 20 cm, 8"

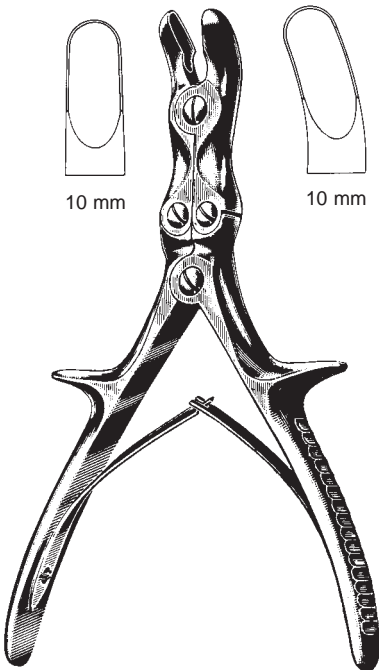

— STILLE-LUER —  
 33230-22 22 cm, 8 3/4" 33231-22  
 33230-26 26 cm, 10 1/4" 33231-26

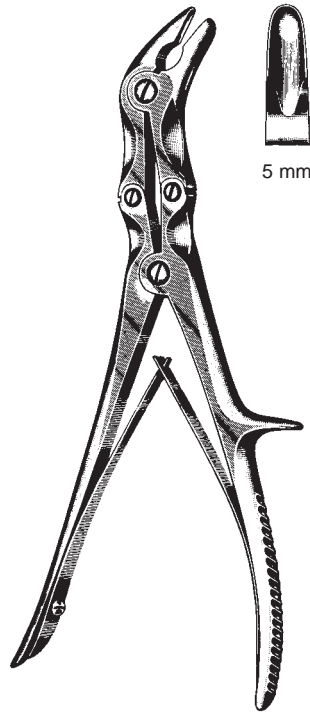

STILLE-LUER  
 33235-23  
 23 cm, 9"

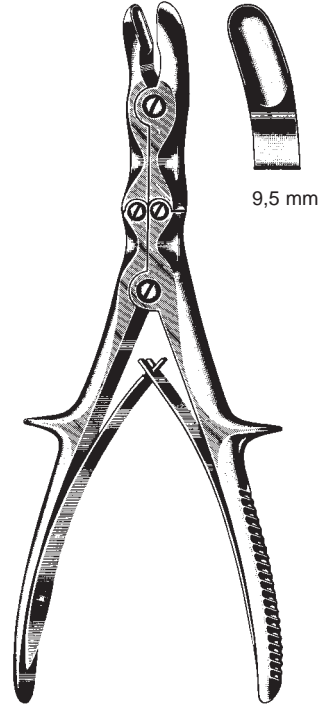

STILLE-RUSKIN  
 33237-23  
 23 cm, 9"

Hohlmeißelzangen  
 Bone Rongeurs  
 Pinzas-gubias  
 Pinze sgorbie

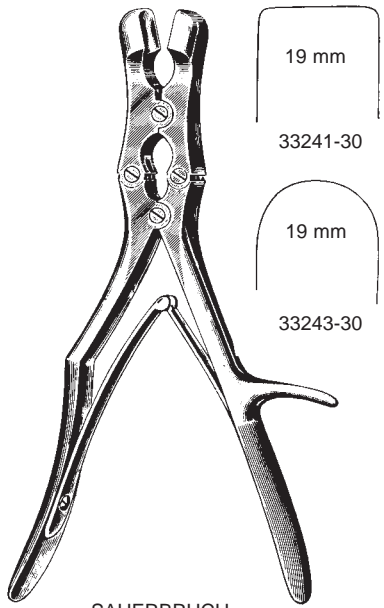

SAUERBRUCH  
 30 cm, 10 3/4"

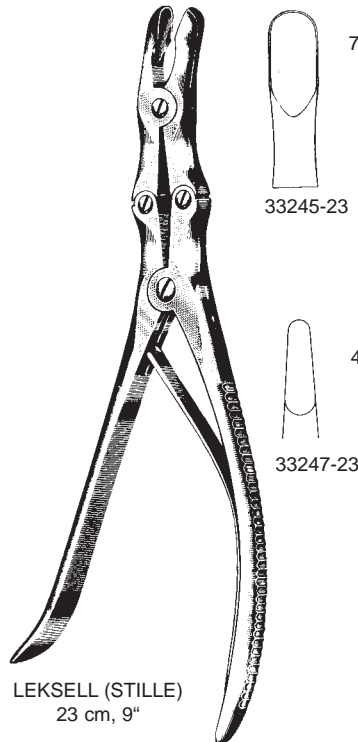

LEKSELL (STILLE)  
 23 cm, 9"

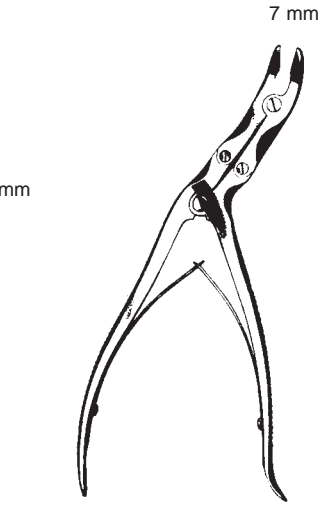

R 33251-26 rechts right derecha a destra  
 L 33253-26 links left izquierda a sinistra  
 SCAGLIETTI  
 26 cm, 10 1/4"



ECHLIN  
 33257-23 2 mm  
 33258-23 4 mm  
 33259-23 3 mm  
 23 cm, 9"



FRYKHOLM  
 33260-24  
 24 cm, 9 1/2"

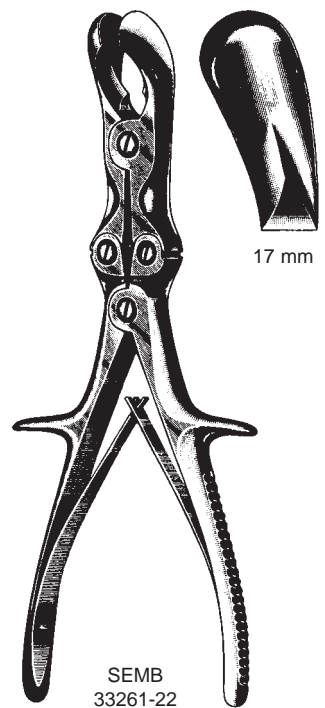

SEMB  
 33261-22  
 22,5 cm, 8,9"

Knochensplitterzangen  
 Bone Cutting Forceps  
 Pinzas cortantes para huesos  
 Cesioie per ossa

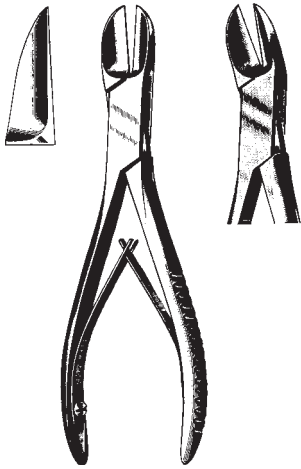

LISTON

- |          |               |          |
|----------|---------------|----------|
| 33274-14 | 14 cm, 5 1/2" | 33275-14 |
| 33274-17 | 17 cm, 6 3/4" | 33275-17 |
| 33274-19 | 19 cm, 7 1/2" | 33275-19 |
| 33274-22 | 22 cm, 8 3/4" | 33275-22 |



BÖHLER

- |           |          |
|-----------|----------|
| 33280-15  | 33281-15 |
| 15 cm, 6" |          |



COTTLE-KAZANJIAN

- |               |
|---------------|
| 33282-19      |
| 19 cm, 7 1/2" |



MC INDOE  
 33283-17  
 17 cm, 6 3/4"



STAMM  
 33284-15  
 15 cm, 6"

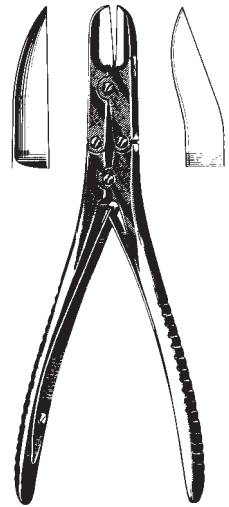

RUSKIN-LISTON

- |           |          |
|-----------|----------|
| 33286-18  | 33289-18 |
| 18 cm, 7" |          |



Knochensplitterzangen  
 Bone Cutting Forceps  
 Pinzas cortantes para huesos  
 Cesioie per ossa

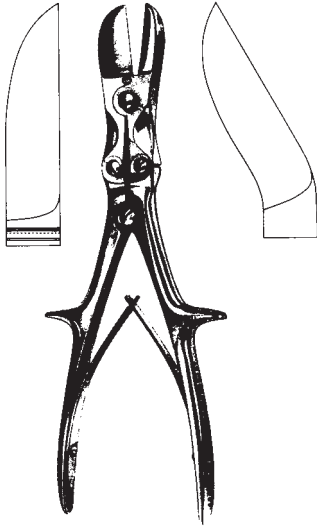

— STILLE-LISTON —  
 33290-23 23 cm, 9" 33291-23  
 33290-27 27 cm, 10 1/2" 33291-27



STILLE-LISTON  
 33292-26  
 26 cm, 10 1/4"

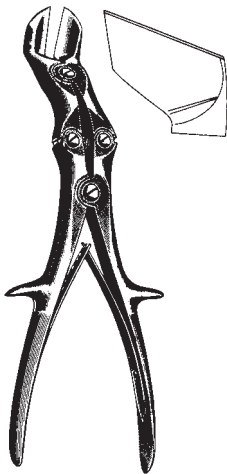

STILLE-HORSLEY  
 33293-27  
 27 cm, 10 1/2"

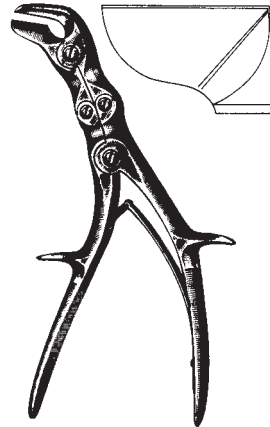

SEMB  
 33295-24  
 24 cm, 9 1/2"

Knochenhalte­zangen  
 Bone Holding Forceps  
 Pinzas para huesos  
 Tenaglie per ossa

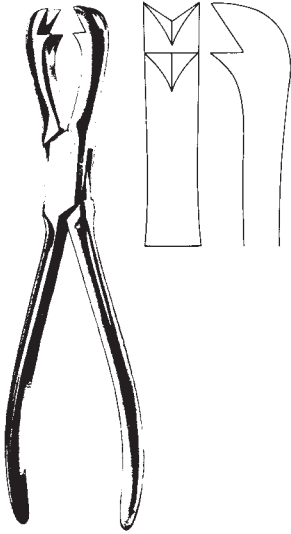

FERGUSSON  
 33360-21  
 21 cm, 8 1/4"

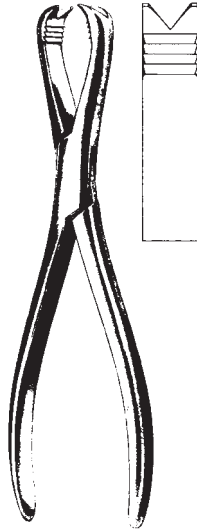

LANGENBECK  
 33362-21  
 21 cm, 8 1/4"

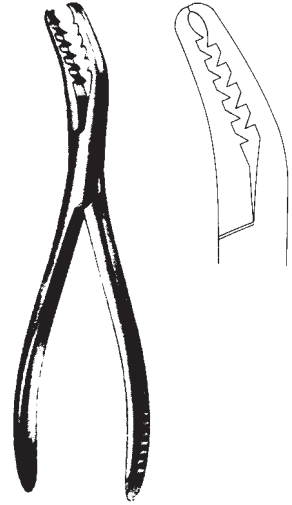

SEMB  
 33365-19 19 cm, 7 1/2"



SEMB  
 33366-19 20 cm, 8"  
 mit Sperre



FARABEUf  
 33366-23 23 cm, 9"  
 33366-26 26 cm, 10 1/4"



FARABEUf-LAMBOTTE  
 33368-26  
 26 cm, 10 1/4"

Knochenhalte­zangen  
 Bone Holding Forceps  
 Pinzas para huesos  
 Tenaglie per ossa

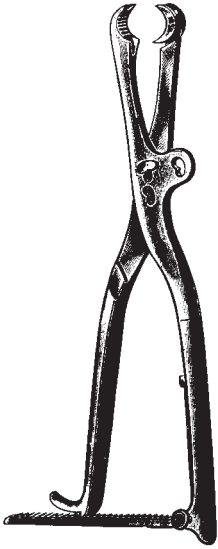

LAMBOTTE

33370-22 22 cm, 8 3/4"  
 33370-27 27 cm, 10 1/2"  
 33370-30 30 cm, 11 3/4"

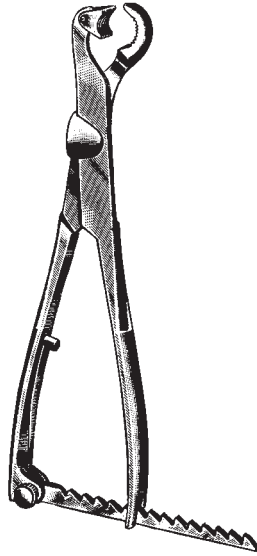

LAMBOTTE

33372-22 22 cm, 8 3/4"  
 33372-26 26 cm, 10 1/4"  
 33372-33 33 cm, 13"

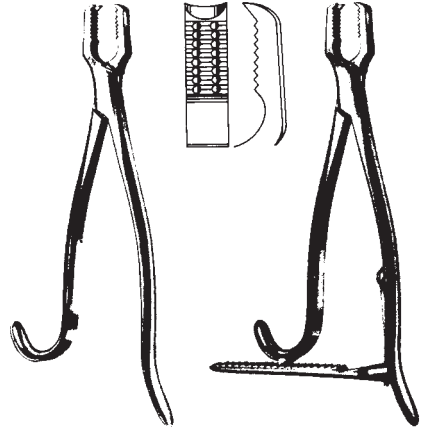

KERN

33378-15 15 cm, 6" 33380-15  
 33378-17 17 cm, 6 3/4" 33380-17  
 33378-21 21 cm, 8 1/4" 33380-21

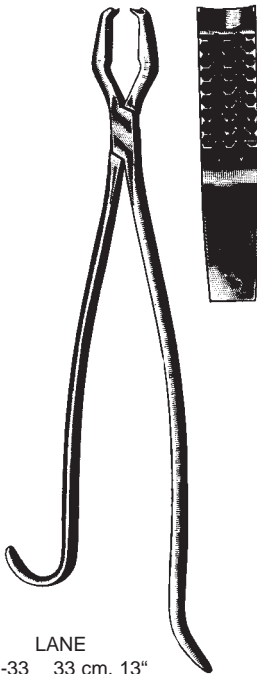

LANE

33382-33 33 cm, 13"  
 33382-45 45 cm, 17 3/4"

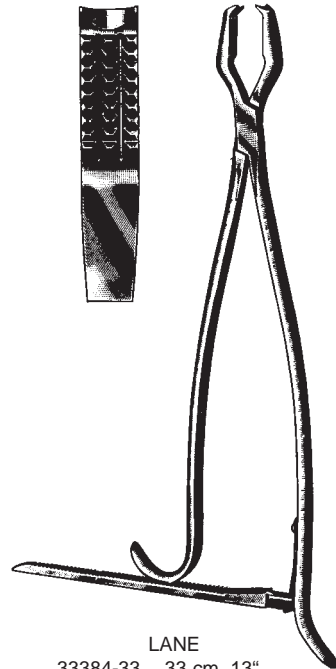

LANE

33384-33 33 cm, 13"  
 33384-45 45 cm, 17 3/4"

Knochenhaltezangen  
 Bone Holding Forceps  
 Pinzas para huesos  
 Tenaglie per ossa

selbstzentrierend  
 self-centering  
 autocentrantes  
 autocentranti

2,5 mm



33391-15  
 15 cm, 6"

6,5 mm

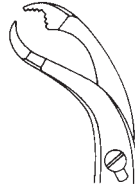

33391-19  
 19 cm, 7 1/2"

9,5 mm

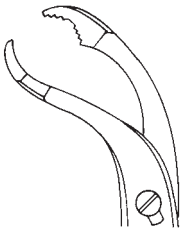

33391-24  
 24 cm, 9 1/2"

10 mm

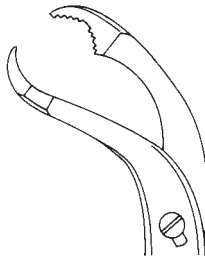

33391-26  
 26 cm, 10 1/4"

11 mm

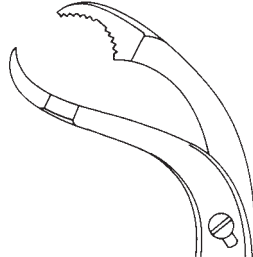

33391-28  
 28 cm, 11"

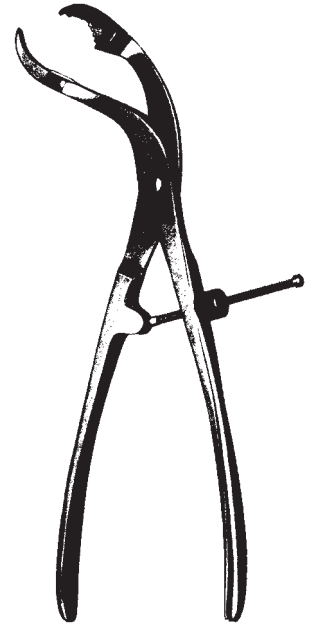

33391-15 - 33391-28

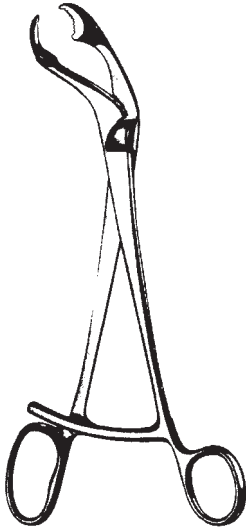

VERBRUGGE  
 33395-17 - 33395-27

5 mm



33395-17  
 17,5 cm, 7"

9,5 mm

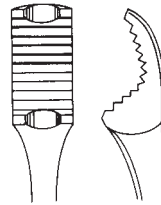

33395-25  
 25 cm, 10"

10,5 mm

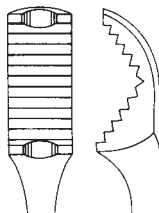

33395-26  
 26 cm, 10 1/4"

12 mm

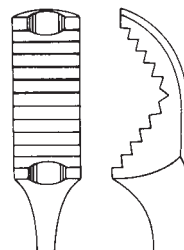

33395-27  
 27 cm, 10 1/2"

Knochenhaltezangen  
 Bone Holding Forceps  
 Pinzas para huesos  
 Tenaglie per ossa

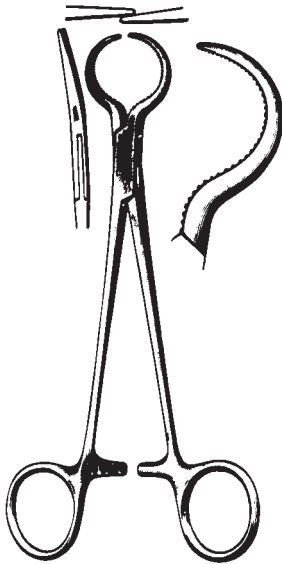

LEWIN  
 33402-17  
 17,5 cm, 7"



BIRCHER-GANSKE  
 33404-20 33405-20  
 20 cm, 8"



33406-20  
 20 cm, 8"



DINGMANN  
 33407-19  
 19 cm, 7 1/2"



REDA  
 33409-13  
 13,5 cm, 5 1/4"



MARTIN  
 33410-19  
 19 cm, 7 1/2"

Knochenhaltezangen  
 Bone Holding Forceps  
 Pinzas para huesos  
 Tenaglie per ossa

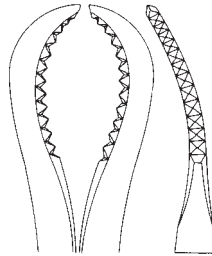

33412-16  
 16 cm, 6 1/4"

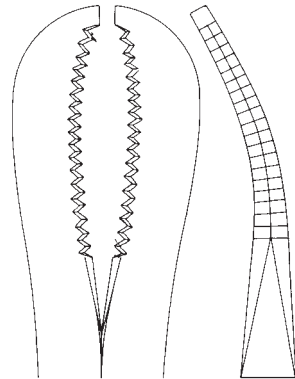

33412-24  
 24 cm, 9 1/2"

REDA  
 33412-16 - 33412-24

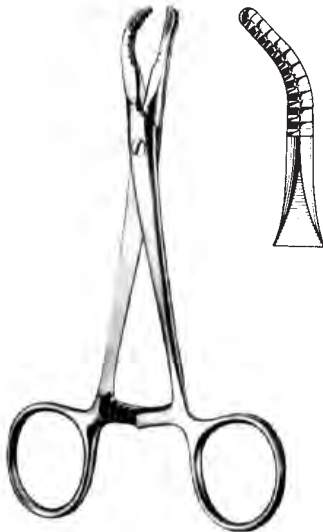

REDA  
 33413-14  
 13,5 cm, 5 1/4"



33414-21  
 21 cm, 8 1/4"

Knochenhalte­zangen  
 Bone Holding Forceps  
 Pinzas para huesos  
 Tenaglie per ossa



ULRICH  
 33415-23 - 33415-28

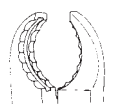
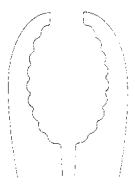

33415-23  
 23 cm, 9"

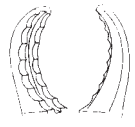

33415-25  
 25 cm, 10"

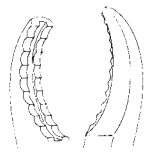

33415-28  
 28 cm, 11"

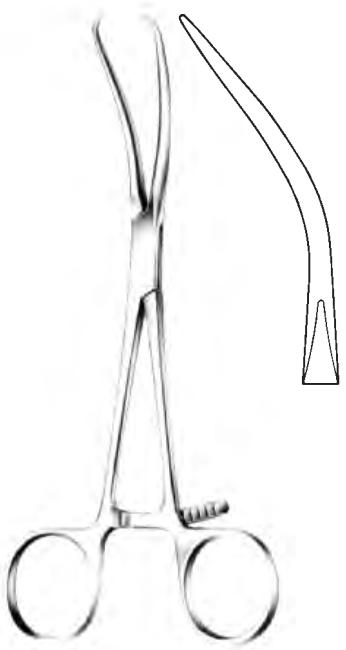

REILL  
 33416-17  
 17 cm, 6 3/4"

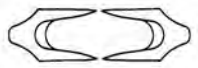

PATELLA  
 33417-18  
 18,5 cm, 7 1/4"

Knochenhaltezeugen, -Klammern  
 Bone holding forceps, -Clamps  
 Pinzas para huesos, Clamps porta-huesos  
 Tenaglie per ossa, Pinze per ossa

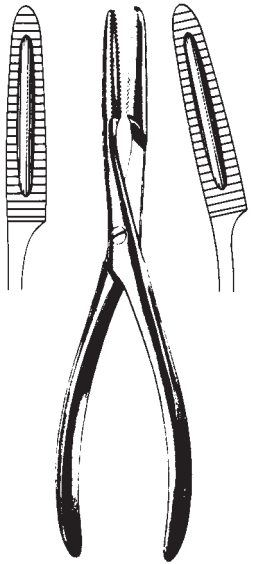

33420-20 33421-20  
 20 cm, 8"

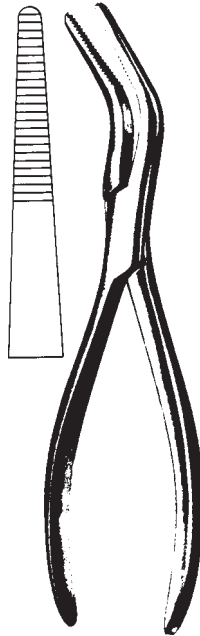

VAN BUREN  
 33423-23  
 23 cm, 9"



FELDHEIM  
 33424-10  
 10 cm, 4"



LOWMAN  
 33441-13 13 cm, 5 1/8"  
 33441-18 18 cm, 7"  
 33441-20 20 cm, 8"



LOWMAN-HOGLUND  
 33442-19  
 19 cm, 7 1/2"

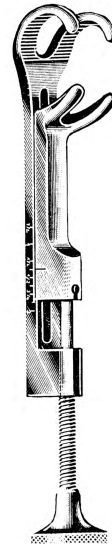

LAMBERT-LOWMAN  
 33443-18  
 18 cm, 7"



Knochenhalte­zangen, Bleihand  
Bone holding forceps, Lead Hands  
Pinzas para huesos, Manoplas de plomo  
Tenaglie per ossa, Mani di piombo

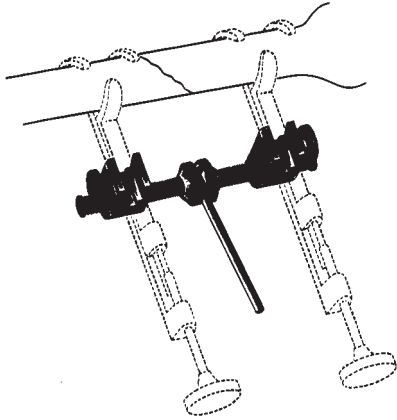

GERSTER  
33444-15



33450-01  
32 cm, 12 <sup>3</sup>/<sub>4</sub>"  
Erwachsen  
adult size  
p. adultos  
p. adulti

33450-02  
24 cm, 9 <sup>1</sup>/<sub>2</sub>"  
Kind  
child size  
p. niños  
p. bambini

Scharfe Löffel  
Bone Curettes  
Cucharillas cortantes  
Curette taglianti

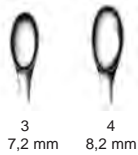
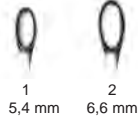
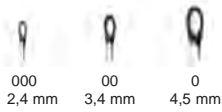

SCHEDE	Fig.	VOLKMANN
	0000	33469-96
33467-97	000	33469-97
33467-98	00	33469-98
33468-00	0	33470-00
33468-01	1	33470-01
33468-02	2	33470-02
33468-03	3	33470-03
33468-04	4	33470-04
	5	33470-05
	6	33470-06

SCHEDE  
17 cm, 6 3/4"  
33467-97 - 33468-04

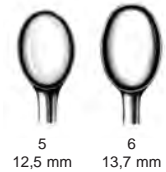
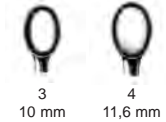
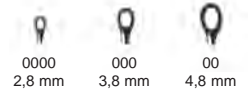

VOLKMANN  
17 cm, 6 3/4"  
33469-96 - 33470-06

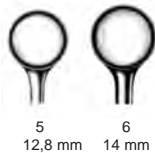
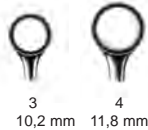

BRUNS	Fig.	SPRATT
33471-96	0000	33474-96
33471-97	000	33474-97
33471-98	00	33474-98
33472-00	0	33475-00
33472-01	1	33475-01
33472-02	2	33475-02
33472-03	3	33475-03
33472-04	4	33475-04
33472-05	5	33475-05
33472-06	6	33475-06

BRUNS  
17 cm, 6 3/4"  
33471-96 - 33472-06

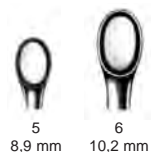
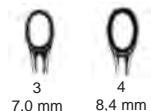
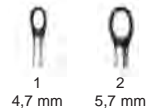
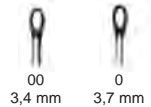

SPRATT  
17 cm, 6 3/4"  
33474-97 - 33475-06

Scharfe Löffel  
Bone Currettes  
Cucharillas cortantes  
Curette taglianti

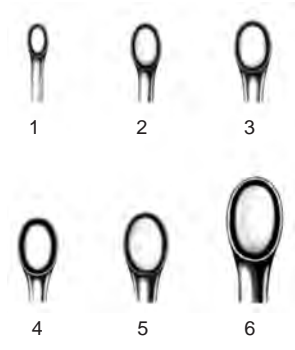

Fig.

1	33473-01	3,5 mm
2	33473-02	4,5 mm
3	33473-03	5,5 mm
4	33473-04	7,5 mm
5	33473-05	8,5 mm
6	33473-06	10,0 mm

COBB  
27,9 cm 11"

Scharfe Löffel  
Bone Curettes  
Cucharillas cortantes  
Curette taglienti

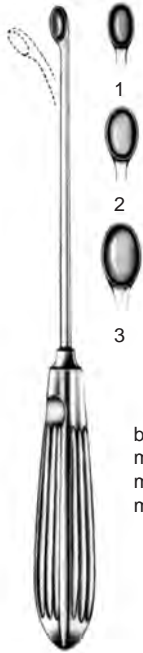

Fig.

1	33476-01	4,8 mm
2	33476-02	5,8 mm
3	33476-03	6,8 mm

biegsam  
malleable  
maleable  
malleabile

HALLÉ  
21 cm, 8 1/4"  
33476-01 - 33476-02



Fig.

000	33476-98	2,8 mm
00	33476-99	3,3 mm
0	33477-00	3,7 mm
1	33477-01	4,3 mm
2	33477-02	4,8 mm
3	33477-03	5,6 mm
4	33477-04	6,1 mm
5	33477-05	6,7 mm
6	33477-06	8,8 mm

SPINAL  
20 cm, 8"  
33476-98 - 33477-06

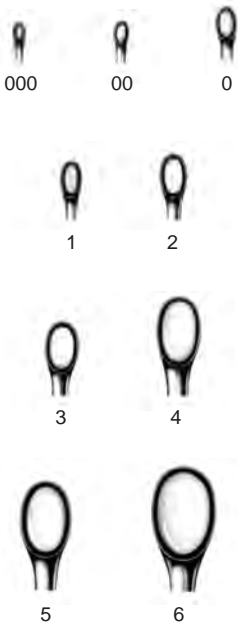

Fig.

000	33478-98	2,8 mm
00	33478-99	3,3 mm
0	33479-00	3,7 mm
1	33479-01	4,3 mm
2	33479-02	4,8 mm
3	33479-03	5,6 mm
4	33479-04	6,1 mm
5	33479-05	6,7 mm
6	33479-06	8,8 mm

SPINAL  
20 cm, 8"  
33478-98 - 33479-06



33482-01 4,7 mm



33482-02 4,7 mm



33482-03 4,7 mm

SCOVILLE  
25 cm, 10"  
33482-01 - 33482-03

Scharfe Löffel  
 Bone Curettes  
 Cucharillas cortantes  
 Curette taglienti

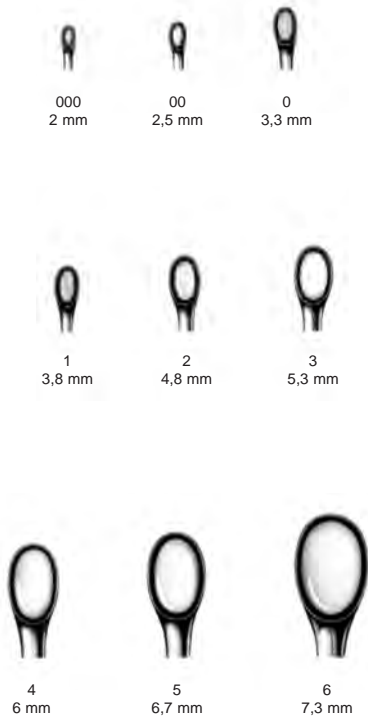

BRUNS  
 23 cm, 9"



BRUNS  
 23 cm, 9"



BRUNS  
 23 cm, 9"

Fig.					
000	33480-97	33482-97	2,8 mm	33484-97	2,8 mm
00	33480-98	33482-98	3,3 mm	33484-98	3,3 mm
0	33481-00	33483-00	3,7 mm	33485-00	3,7 mm
1	33481-01	33483-01	4,3 mm	33485-01	4,3 mm
2	33481-02	33483-02	4,8 mm	33485-02	4,8 mm
3	33481-03	33483-03	5,6 mm	33485-03	5,6 mm
4	33481-04	33483-04	6,1 mm	33485-04	6,1 mm
5	33481-05	33483-05	6,7 mm	33485-05	6,7 mm
6	33481-06	33483-06	8,8 mm	33485-06	8,8 mm

Scharfe Löffel  
Bone Curettes  
Cucharillas cortantes  
Curette taglienti

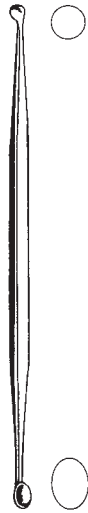

33485-21 21 cm, 8 1/2"  
oval/rund  
ovale/ronde  
ovalado/redondo  
ovale/rotonda



WILLIGER  
17,5 cm  
7"

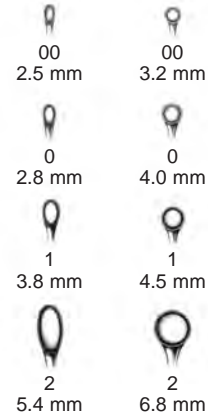
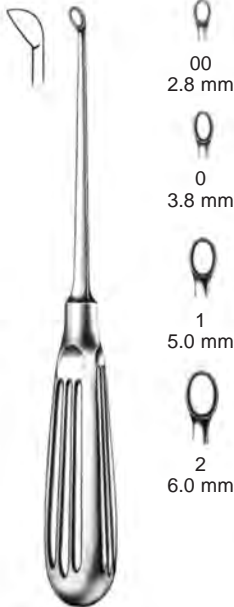

Fig. 00	33485-99	33486-99
0	33486-00	33487-00
1	33486-01	33487-01
2	33486-02	33487-02



DAUBENSPECK	Fig. 00	33487-99
20 cm, 8"	0	33488-00
	1	33488-01
	2	33488-02



27 cm	Fig. 0	33489-00
10 1/2"	1	33489-01
	2	33489-02
	3	33489-03

Scharfe Löffel  
 Bone Curettes  
 Cucharillas cortantes  
 Curette taglianti



LEMPERT  
 17,5 cm, 7"



0



00



000



0000



00000

Fig. 0	33490-10	3,3 mm
00	33490-20	3,0 mm
000	33490-30	2,7 mm
0000	33490-40	2,4 mm
00000	33490-50	2,0 mm



REDA  
 25 cm, 10"



000  
 3,6 mm

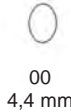

00  
 4,4 mm

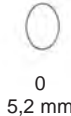

0  
 5,2 mm

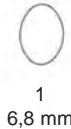

1  
 6,8 mm

Fig. 000	33491-05
00	33491-06
0	33491-07
1	33491-08



REDA  
 25 cm, 10"



000  
 3,6 mm

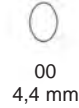

00  
 4,4 mm

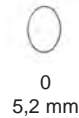

0  
 5,2 mm

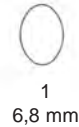

1  
 6,8 mm

Fig. 000	33500-01
00	33500-02
0	33500-03



BUSHE  
 25 cm, 10"

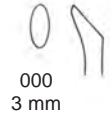

000  
 3 mm



00  
 4 mm

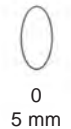

0  
 5 mm

Scharfe Löffel  
Bone Curettes  
Cucharillas cortantes  
Curette taglianti



33492-13 6.3 mm  
33492-16 7.0 mm  
33492-20 9.1 mm

33492-13 6.8 mm  
33492-16 9.0 mm  
33492-20 11.1 mm

VOLKMANN

33492-13 13 cm, 5 1/8"  
33492-16 16 cm, 6 1/4"  
33492-20 20 cm, 8"



33494-13 7.5 mm  
33494-14 6.8 mm  
33494-17 6.8 mm

33494-13 6.3 mm  
33494-14 6.2 mm  
33494-17 7.3 mm

VOLKMANN

33494-13 13 cm, 5 1/8"  
33494-14 14 cm, 5 1/2"  
33494-17 17 cm, 6 3/4"

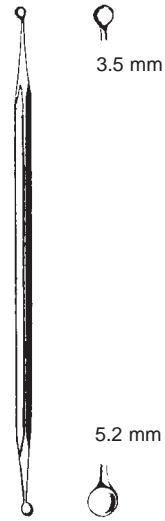

3.5 mm

5.2 mm

JANSE

33495-16  
16 cm, 6 1/4"

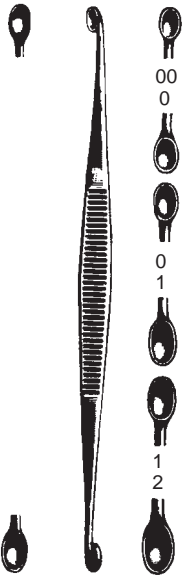

00 2.5 mm  
0 3.0 mm

0 3.0 mm  
1 3.5 mm

1 3.5 mm  
2 4.0 mm

WILLIGER

13,5 cm, 5 1/4" Fig.  
33496-00 00/0  
33496-01 0/1  
33496-12 1/2



4.0 mm

3.4 mm

JACOBSON

13 cm, 5 1/8"  
33497-00

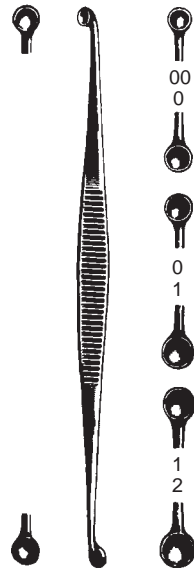

00 2.5 mm  
0 3.1 mm

0 3.1 mm  
1 3.5 mm

1 3.5 mm  
2 4.0 mm

MARTINI

13,5 cm, 5 1/4"  
33498-00  
33498-01  
33498-12



Stößel  
Hemostats  
Hemostáticos  
Pistoni



CASPAR  
200 mm, 8"



33509-03  
Ø 3 mm



33509-05  
Ø 5 mm



33509-08  
Ø 8 mm



200 mm, 8"



33510-12  
Ø 12 mm

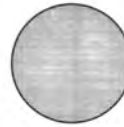

33510-14  
Ø 14 mm



33510-16  
Ø 16 mm

Stößel, Flachmeißel, Hohlmeißel  
 Hemostats, Chisels, Gouges  
 Hemostáticos, Cinceles, Gubias  
 Pistoni, scalpelli, sgorbie

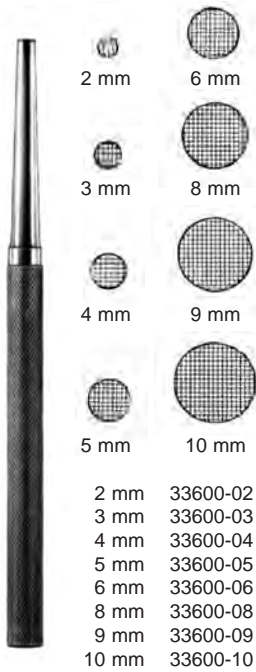

- |       |          |
|-------|----------|
| 2 mm  | 33600-02 |
| 3 mm  | 33600-03 |
| 4 mm  | 33600-04 |
| 5 mm  | 33600-05 |
| 6 mm  | 33600-06 |
| 8 mm  | 33600-08 |
| 9 mm  | 33600-09 |
| 10 mm | 33600-10 |

16 cm, 6 1/4"



13,5 cm, 5 1/4"



13,5 cm, 5 1/4"



13,5 cm, 5 1/4"

- |       |          |          |          |
|-------|----------|----------|----------|
| 4 mm  | 33602-04 | 33604-04 | 33605-04 |
| 6 mm  | 33602-06 | 33604-06 | 33605-06 |
| 8 mm  | 33602-08 | 33604-08 | 33605-08 |
| 10 mm | 33602-10 | 33604-10 | 33605-10 |
| 12 mm | 33602-12 | 33604-12 | 33605-12 |
| 14 mm | 33602-14 | 33604-14 | 33605-14 |
| 16 mm | 33602-16 | 33604-16 | 33605-16 |



ALEXANDER  
 17 cm, 6 3/4"

- |          |       |
|----------|-------|
| 33610-04 | 4 mm  |
| 33610-06 | 6 mm  |
| 33610-08 | 8 mm  |
| 33610-10 | 10 mm |
| 33610-12 | 12 mm |
| 33610-14 | 14 mm |

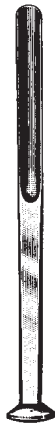

ALEXANDER  
 17 cm, 6 3/4"

- |          |       |
|----------|-------|
| 33611-04 | 4 mm  |
| 33611-06 | 6 mm  |
| 33611-08 | 8 mm  |
| 33611-10 | 10 mm |
| 33611-12 | 12 mm |
| 33611-14 | 14 mm |



PARTSCH  
 13,5 cm, 5 1/4" mm 17 cm, 6 3/4"

- |          |   |          |
|----------|---|----------|
| 33620-02 | 2 | 33622-02 |
| 33620-03 | 3 | 33622-03 |
| 33620-04 | 4 | 33622-04 |
| 33620-05 | 5 | 33622-05 |
| 33620-06 | 6 | 33622-06 |
| 33620-07 | 7 | 33622-07 |
| 33620-08 | 8 | 33622-08 |



PARTSCH  
 13,5 cm, 5 1/4" mm 17 cm, 6 3/4"

- |          |   |          |
|----------|---|----------|
| 33623-02 | 2 | 33625-02 |
| 33623-03 | 3 | 33625-03 |
| 33623-04 | 4 | 33625-04 |
| 33623-05 | 5 | 33625-05 |
| 33623-06 | 6 | 33625-06 |
| 33623-07 | 7 | 33625-07 |
| 33623-08 | 8 | 33625-08 |

Flachmeißel, Hohlmeißel  
 Chisels, Gouges  
 Cinceles, Gubias  
 Scalpelli, sgorbie

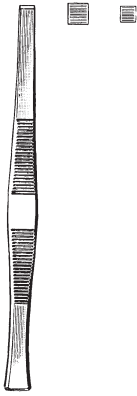

**PASSOW**  
 12 cm, 4 3/4"  
 33626-35 3,5 mm  
 33626-25 2,5 mm



**BRÜNINGS-LUCAS**  
 16 cm, 6 1/4"  
 33627-04 4 mm  
 33627-06 6 mm

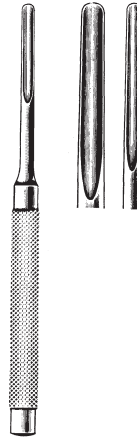

**BRÜNINGS-LUCAS**  
 16 cm, 6 1/4"  
 33628-03 3 mm  
 33628-05 5 mm



**STILLE**  
 20 cm, 8"  
 33630-06 6 mm  
 33630-08 8 mm  
 33630-10 10 mm  
 33630-12 12 mm  
 33630-15 15 mm  
 33630-20 20 mm  
 33630-25 25 mm  
 33630-30 30 mm



**STILLE**  
 20 cm, 8"

6 mm  
 8 mm  
 10 mm  
 12 mm  
 15 mm  
 20 mm  
 25 mm  
 30 mm  
 33631-10  
 33631-12  
 33631-15  
 33631-20  
 33631-25  
 33631-30



**STILLE**  
 20 cm, 8"

6 mm  
 8 mm  
 10 mm  
 12 mm  
 15 mm  
 20 mm  
 25 mm  
 30 mm  
 33632-06  
 33632-08  
 33632-10  
 33632-12  
 33632-15  
 33632-20  
 33632-25  
 33632-30



**STILLE**  
 20 cm, 8"

6 mm  
 8 mm  
 10 mm  
 12 mm  
 15 mm  
 20 mm  
 25 mm  
 30 mm  
 33633-06  
 33633-08  
 33633-10  
 33633-12  
 33633-15  
 33633-20  
 33633-25  
 33633-30



**STILLE**  
 20 cm, 8"

6 mm  
 8 mm  
 10 mm  
 12 mm  
 15 mm  
 20 mm  
 25 mm  
 30 mm  
 33634-06  
 33634-08  
 33634-10  
 33634-12  
 33634-15  
 33634-20  
 33634-25  
 33634-30

Osteotome, Hohlmeißel  
 Chisels, Gouges  
 Cinceles, Gubias  
 Scalpelli, sgorbie



SMITH-PETERSEN  
 20 cm, 8"

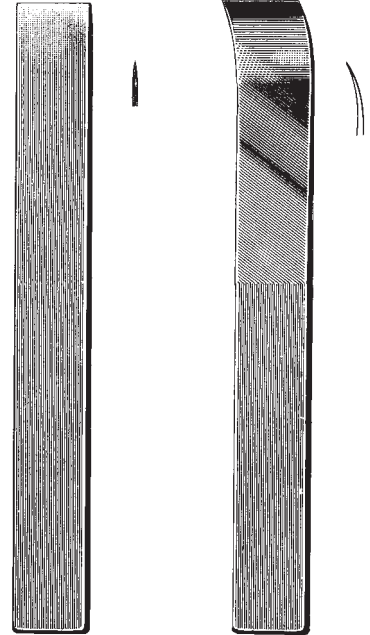

LAMBOTTE  
 24 cm, 9 1/2"      23 cm, 9"

6 mm	33644-06	33645-06	33647-06	
9 mm	33644-09	33645-09	33647-09	33649-09
13 mm	33644-13	33645-13		
14 mm			33647-14	33649-14
16 mm	33644-16	33645-16	33647-16	33649-16
19 mm	33644-19	33645-19	33647-19	33649-19
25 mm	33644-25	33645-25	33647-25	33649-25
32 mm	33644-32	33645-32	33647-32	33649-32

33650-04	4 mm	33651-04
33650-06	6 mm	33651-06
33650-08	8 mm	33651-08
33650-10	10 mm	33651-10
33650-13	13 mm	33651-13
33650-16	16 mm	33651-16
33650-18	18 mm	33651-18
33650-20	20 mm	33651-20
33650-25	25 mm	33651-25
33650-30	30 mm	33651-30
33650-38	38 mm	33651-38
33650-44	44 mm	33651-44
33650-50	50 mm	33651-50

Osteotome, Hohlmeißel  
 Chisels, Gouges  
 Cinceles, Gubias  
 Scalpelli, sgorbie



MINI-LAMBOTTE



2 mm



3 mm



4 mm



6 mm



8 mm



10 mm



12 mm



15 mm

12,5 cm, 5"	mm	17 cm, 6 3/4"
33654-02	2	33652-02
33654-03	3	33652-03
33654-04	4	33652-04
33654-06	6	33652-06
33654-08	8	33652-08
33654-10	10	33652-10
33654-12	12	33652-12
33654-15	15	33652-15

Hohlmeißel mit Ferrozellgriff  
 Gouges with Ferrozell-Handle  
 Gubias con mango de Ferrozell  
 Sgorbie con manico di Ferrozell

8 mm



COBB  
 28 cm, 11"  
 33656-28

8 mm



COBB  
 28 cm, 11"  
 33657-28

8 mm



COBB  
 28 cm, 11"  
 33658-28

8 mm



COBB  
 28 cm, 11"  
 33659-28

Osteotome, Hohlmeißel mit Ferrozell-Griff  
 Chisels and Gouges with Ferrozell-Handle  
 Gubias con mango de Ferrozell  
 Osteotomo, con manico di Ferrozell

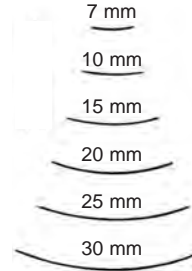
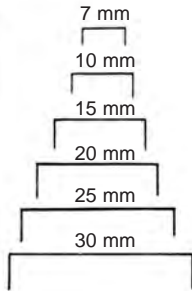

LEXER  
 22 cm, 8 3/4"

LEXER  
 22 cm, 8 3/4"

33660-07	7 mm	33661-07
33660-10	10 mm	33661-10
33660-15	15 mm	33661-15
33660-20	20 mm	33661-20
33660-25	25 mm	33661-25
33660-30	30 mm	33661-30

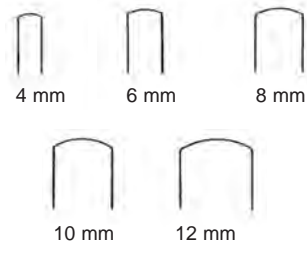
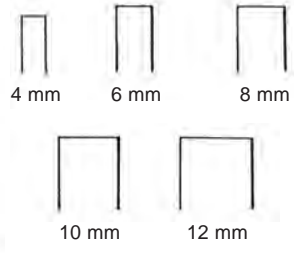

LEXER MINI  
 18 cm, 7"

LEXER MINI  
 18 cm, 7"

33664-04	4 mm	33665-04
33664-06	6 mm	33665-06
33664-08	8 mm	33665-08
33664-10	10 mm	33665-10
33664-12	12 mm	33665-12

Flachmeißel, Hohlmeißel  
 Chisels, Gouges  
 Cinceles, Gubias  
 Scalpelli, sgorbie



20 mm

33665-24  
 24,5 cm, 9 3/4"



16 mm

33665-26  
 26,5 cm, 10 1/2"

Hohlmeißel mit NOVOTEX-Griff  
 Gouges with Novotex-Handle  
 Gubias con mango de Novotex  
 Sgorbie con manico di Novotex



ZIELKE 23 cm, 9"  
 33665-55 5,5 mm  
 33665-90 9,0 mm



9 mm

22 cm, 8 3/4"  
 33666-22

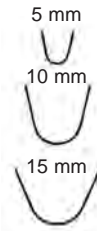

—	25 cm, 10"	⌒
33669-05	5 mm	33670-05
33669-10	10 mm	33670-10
33669-15	15 mm	33670-15

Flachmeißel, Hohlmeißel

Chisels, Gouges

Cinceles, Gubias

Scalpelli, Sgorbie



HOKE

14 cm, 5 1/2"

33668-03	3 mm
33668-05	5 mm
33668-06	6 mm
33668-08	8 mm
33668-09	9 mm
33668-13	13 mm
33668-16	16 mm
33668-19	19 mm



HIBBS

24 cm, 9 1/2"

33670-06	6 mm
33670-09	9 mm
33670-13	13 mm
33670-16	16 mm
33670-19	19 mm
33670-25	25 mm
33670-32	32 mm



HIBBS

24 cm, 9 1/2"

33671-06	6 mm
33671-09	9 mm
33671-13	13 mm
33671-16	16 mm
33671-19	19 mm
33671-25	25 mm
33671-32	32 mm



HIBBS

24 cm, 9 1/2"

33672-06	6 mm
33672-09	9 mm
33672-13	13 mm
33672-16	16 mm
33672-19	19 mm
33672-25	25 mm
33672-32	32 mm



HIBBS

24 cm, 9 1/2"

33673-06	6 mm
33673-09	9 mm
33673-13	13 mm
33673-16	16 mm
33673-19	19 mm
33673-25	25 mm
33673-32	32 mm



HIBBS

24 cm, 9 1/2"

33675-06	6 mm
33675-09	9 mm
33675-13	13 mm
33675-16	16 mm
33675-19	19 mm
33675-25	25 mm
33675-32	32 mm



Meißel  
Chisels  
Cinceles  
Scalpelli

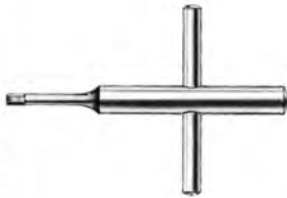

33676-02  
9 cm, 3 1/2"  
Spannschlüssel  
Key  
Llave  
Clé  
Chiave



5 mm  
33676-05  
8,5 mm, 3.4"



10 mm  
33676-10  
8,5 mm, 3.4"



16 mm  
33676-16  
8,5 mm, 3.4"



25 mm  
33676-25  
8,5 mm, 3.4"

Meißelklingen  
auswechselbar  
Chisel blades  
interchangeable  
Hojas de cincel  
intercambiables  
Lame intercambiabili

33676-01  
18,5 cm, 7 1/4"  
Griff allein  
Handle only  
Mango suelto  
Manico solo



5 mm  
33677-05  
8,5 mm, 3.4"



10 mm  
33677-10  
8,5 mm, 3.4"



16 mm  
33677-16  
8,5 mm, 3.4"

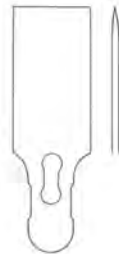

25 mm  
33677-25  
8,5 mm, 3.4"

Osteotomklingen  
auswechselbar  
Osteotome blades  
interchangeable  
Hojas de osteótomo  
intercambiables  
Lame per osteotomia  
intercambiabili

Schädelspalter, Rachiotor, Sternummeißel, Osteotom, Muskelhaken  
 Skull breaker, Rachiotor, Sternum Chisel, Osteotome, Muscle hooks  
 Cincel rompe-cráneo, Raquíótomos, Cinceles de esternón, Osteotomo, Ganchos musculare  
 Divisore per cranio, Rachiotori, Scalpello per sterno, Osteotomo, Uncino per muscoli



LEBSCHKE  
 33678-24  
 24,5 cm, 9 3/4"



23 mm  
 33679-13  
 13 cm, 5 1/8"



33680-22  
 14 cm, 5 1/2"



33682-22  
 22 cm, 8 3/4"



19902-10  
 10 cm, 4"



19903-00

Meißel, Sektionsnadeln  
 Chisels, Post mortem needles  
 Cinceles, Agujas para autopsia  
 Scalpelli, Aghi per autopsia



89146-20 20 cc  
 110 x 20 mm

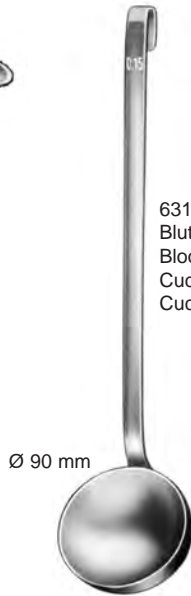

63174-00  
 Blutschöpfer, 150 ccm  
 Blood scoop, 9 cu. inches  
 Cucharra p / sangre  
 Cucchiaino per sangue

Ø 90 mm



BRUNETTI  
 28,5 cm, 11 1/4"

33682-01	33682-02
links	rechts
left	right
izquierdo	derecho
sinistra	destra

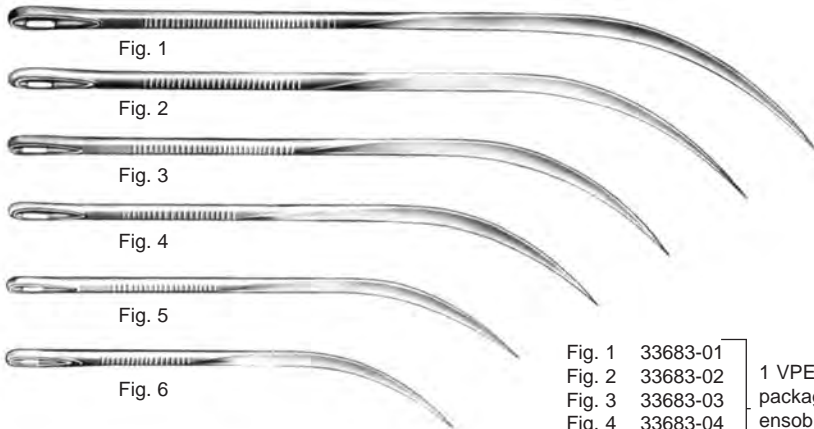

Fig. 1

Fig. 2

Fig. 3

Fig. 4

Fig. 5

Fig. 6

Fig. 1	33683-01
Fig. 2	33683-02
Fig. 3	33683-03
Fig. 4	33683-04
Fig. 5	33683-05
Fig. 6	33683-06

1 VPE = 12 Stk.  
 package of 12  
 ensobres de 12  
 confezione di 12

Obduktionsbesteck  
 Post Mortem Set  
 Estuches para Autopsia  
 Astucci per Autopsia



33684-00

Kleines Besteck, Holzetui, enthaltend:

- 4 Skalpelle
- 1 Knorpelmesser
- 1 Inzisionsschere, 13 cm (5 1/8")
- 1 Anatomische Pinzette, 13 cm (5 1/8")
- 1 Amputationssäge Charrière
- 1 Hammer
- 1 Meißel
- 2 doppelte Muskelhaken
- 2 doppelte Tubuli
- 2 Knopfsonden, 13 cm (5 1/8")
- 3 Wundnadeln

Small set, wooden case, containing:

- 4 Dissecting Knives
- 1 Cartilage Knife
- 1 Incision Scissors, 13 cm (5 1/8")
- 1 Dissecting Forceps, 13 cm (5 1/8")
- 1 Amputation Saw Charrière
- 1 Mallet
- 1 Chisel
- 2 Retractors, double ended
- 2 Blow pipes, double
- 2 Probes, 13 cm (5 1/8")
- 3 Suture Needles

Modelo pequeño, estuche de madera, conteniendo:

- 4 Escalpelos
- 1 Cuchillo para cartilago
- 1 Tijera de incision, 13 cm (5 1/8")
- 1 Pinza para disección, 13 cm (5 1/8")
- 1 Sierra de amputación Charrière
- 1 Martillo
- 1 Escoplo
- 2 Separadores de 2 garfios, dobles
- 2 Tubos insufladores, dobles
- 2 Estiletos olivares, 13 cm (5 1/8")
- 3 Agujas para sutura

Modelo piccolo, astuccio di legno, composto da:

- 4 Bisturi
- 1 Coltello per cartilagine
- 1 Forbice per incisione, 13 cm (5 1/8")
- 1 Pinza anatomica, 13 cm (5 1/8")
- 1 Sega per amputazione, Charrière
- 1 Martello
- 1 Scalpello
- 2 Divaricatori con 2 ganci, doppi
- 2 Tubi inalatori, doppi
- 2 Specilli bottonuti, doppi, 13 cm (5 1/8")
- 3 Aghi per sutura

Hämmer  
 Bone Hammers and Mallets  
 Martillos y mazos  
 Martelli

Ø 25 mm



GERZOG  
 18 cm, 7"  
 33686-25 250 g

Ø 38 mm

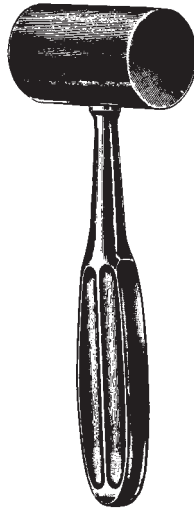

KIRK  
 19 cm, 7 1/2"  
 33687-75 750 g

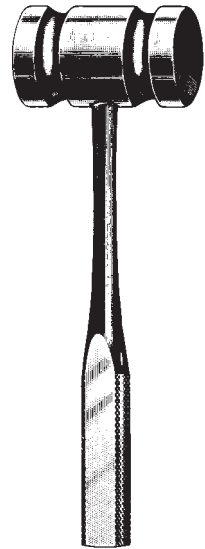

26,5 cm, 10 1/2"  
 33688-45 450 g  
 33689-90 900 g

Ø 30 mm



COLLIN  
 20 cm, 8"  
 33690-22 220 g

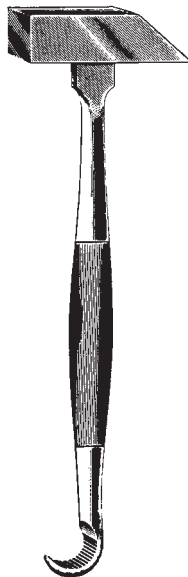

33699-00  
 23,5 cm, 9 1/4"  
 480 g

Ø 25 mm



135 g  
 33694-01 18,5 cm, 7 1/4"  
 33694-03 Ersatzbacken  
 Nylon Caps  
 Tapas de repuesto  
 Placche di ricambio

Hämmer  
Bone Hammers and Mallets  
Martillos y mazos  
Martelli



WILLIGER  
24 cm, 9 1/2"  
33691-34 340 g



Ø 25 mm  
LUCAE  
19 cm, 7 1/2"  
33692-26 260 g

massiv, mit auswechselbaren Ferrozellbacken  
solid, with interchangeable Ferrozell jaws  
macizo, con tapas intercambiables de Ferrozell  
solido, con placche intercambiabili in Ferrozell



Ø 20 mm  
MEAD  
17 cm, 6 3/4"  
33693-32 320 g

33693-33  
Paar Ersatzbacken  
Pair spare jaws  
par de tapas de repuesto  
Coppia di placche di ricambio

33693-34  
Satz Ringe  
Set rings  
juego de anillos  
Set anelli

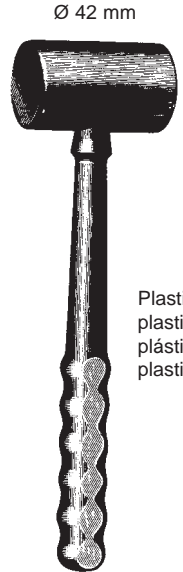

Ø 42 mm  
Plastik  
plastic  
plástico  
plastica  
26 cm, 10 1/4"  
33695-40 400 g



QUISLING  
33696-75



Ø 22 mm  
PARTSCH  
33698-98  
18 cm, 7"  
199 g



Ø 40 mm  
Ø 30 mm  
33699-17  
26,5 cm, 10 1/2"  
530 g

Hämmer  
 Bone Hammers and Mallets  
 Martillos y mazos  
 Martelli

Ø 30 mm



33700-01-01  
 Ersatzbacken  
 Nylon Caps  
 Tapas de repuesto  
 Placche di ricambio

24,5 cm, 9 3/4" 215 g  
 33700-01

Ø 10 mm

Ø 23 mm



Kopf aus  
 Implantatwerkstoff  
 Head made of  
 material used for implants  
 Cabeza de  
 material de implantación  
 Testa in  
 materiale per impianti

23 cm, 9" 350 g  
 33700-02

Ø 45 mm



BERGMANN  
 24 cm, 9 1/2" 300 g  
 33700-03

Ø 30 mm



BERGMANN  
 23 cm, 9" 300 g  
 33700-04

Hämmer  
Bone Hammers and Mallets  
Martillos y mazos  
Martelli

Ø 30 mm



COTTLE  
18 cm, 7" 240 g  
33700-05

Ø 40 mm



HEATH  
18 cm, 7" 700 g  
33700-06

Ø 40 mm



OMBREDANNE  
25 cm, 10" 700 g  
33700-07

Ø 27 mm



HAJEK  
21 cm, 8 1/4" 140 g  
33700-08



Raspatorien  
 Periosteal Elevators  
 Periostótomos  
 Periostotomi

12,5 mm



FARABEU  
 33702-15  
 15 cm, 5.9"

12,5 mm



FARABEU  
 33703-15  
 15 cm, 5.9"

11 mm



FARABEU-COLLIN  
 33704-01  
 15,5 cm, 6"

11 mm

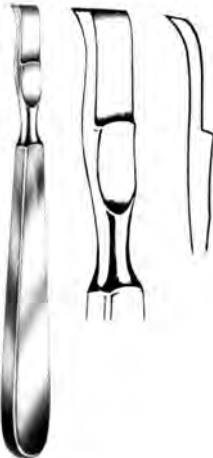

FARABEU-COLLIN  
 33704-02  
 15,5 cm, 6"



LAMBOTTE  
 21 cm, 8 1/4"  
 33705-05 5 mm  
 33705-10 10 mm  
 33705-15 15 mm  
 33705-20 20 mm  
 33705-25 25 mm

18 mm



SEDILLOT  
 18 cm, 7"  
 33706-18

Raspatorien  
 Periosteal Elevators  
 Periostótomos  
 Periostotomi

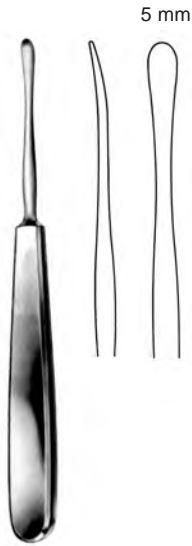

SEBILEAU  
 17,5 cm, 7"  
 33707-17

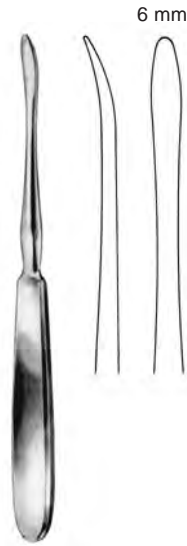

QUERVAIN  
 19,5 cm, 7 3/4"  
 33708-19

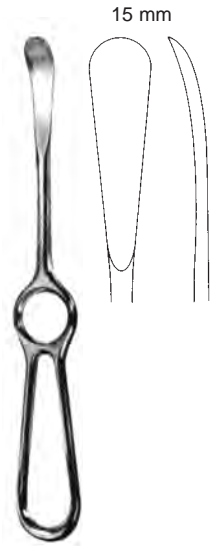

SEDILLOT  
 21 cm, 8 1/4"  
 33709-21



LANGENBECK  
 19 cm, 7 1/2"  
 33710-19



LANGENBECK  
 18 cm, 7"  
 33711-18



LANGENBECK  
 20 cm, 8"  
 33711-20 8 mm  
 33711-21 10 mm

Raspatorien, Elevatoren  
 Raspatories, Elevators  
 Periostótomos, Elevadores  
 Periostotomi, Elevatori

4 mm



WILLIGER  
 33711-16  
 16 cm, 6 1/4"

6,5 mm



WILLIGER  
 33712-16  
 16 cm, 6 1/4"

5 mm



WILLIGER  
 33713-16  
 16 cm, 6 1/4"

5,5 mm



WILLIGER  
 33713-17  
 17 cm, 6 3/4"

5 mm

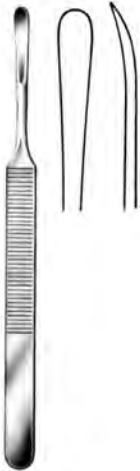

KÖNIG  
 33714-15  
 15,5 cm, 6"

12 mm

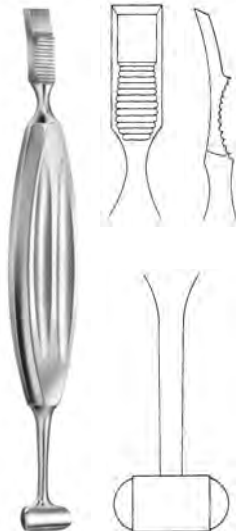

ALEXANDER  
 33715-20  
 21 cm, 8 1/4"



MOLT  
 33716-18  
 18 cm, 7"

Raspatorien, Elevatoren  
 Raspatories, Elevators  
 Periostótomos, Elevadores  
 Periostotomi, Elevatori

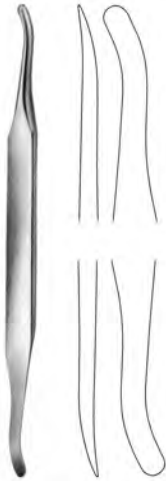

SELDIN  
 33717-19-01  
 19,5 cm 7 3/4"

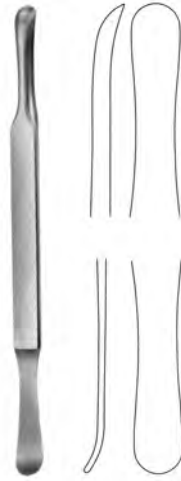

SELDIN  
 33717-19-02  
 19,5 cm 7 3/4"



JOSEPH  
 33718-16  
 16 cm, 6 1/4"



FOMON  
 33719-17  
 17 cm, 6 3/4"



BOIES  
 33720-19  
 19 cm, 7 1/2"



GORNEY  
 33720-21  
 21 cm, 8 1/4"

Raspatorien, Elevatoren  
 Periosteal Elevators  
 Periostótomos, Elevadores  
 Periostotomi, Elevatori

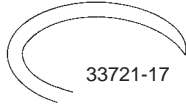

33721-17

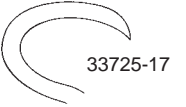

33725-17

DOYEN  
 17 cm, 6 3/4"

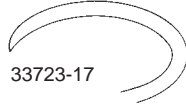

33723-17

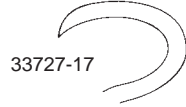

33727-17

DOYEN  
 17 cm, 6 3/4"



DOYEN  
 33728-24 33729-24  
 24 cm 9 1/2"



SEMB

12 mm



33729-01  
 17,5 cm  
 7"

12 mm



33729-02  
 21 cm  
 8 1/4"

12 mm



33729-03  
 17,5 cm  
 7"

13 mm



33729-04  
 21 cm  
 8 1/4"

15 mm



33729-05  
 20,5 cm  
 8"

15 mm



33729-06  
 20,5 cm  
 8"



33729-07  
 22,5 cm  
 8.9"

Elevatoren, Raspatoren  
Elevators, Raspatories  
Elevadores, Periostótomos  
Elevatori, Periostotomi



MATSON-ALEXANDER  
33731-22  
22 cm, 8 3/4"

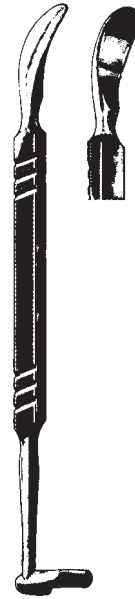

MATSON  
33733-22  
22 cm, 8 3/4"



33740-19  
19 cm, 7 1/2"



33741-18  
18,5 cm, 7 1/4"



33742-18  
18,5 cm, 7 1/4"



33743-18  
18,5 cm, 7 1/4"

Elevatoren, Raspatoren  
 Elevators, Raspatories  
 Elevadores, Periostótomos  
 Elevatori, Periostotomi

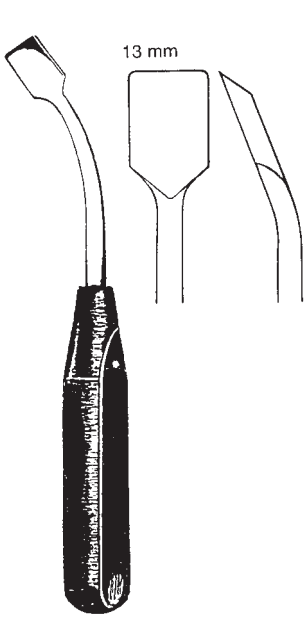

33745-19  
 18,5 cm, 7 1/4"



33746-19  
 19,5 cm, 7 3/4"

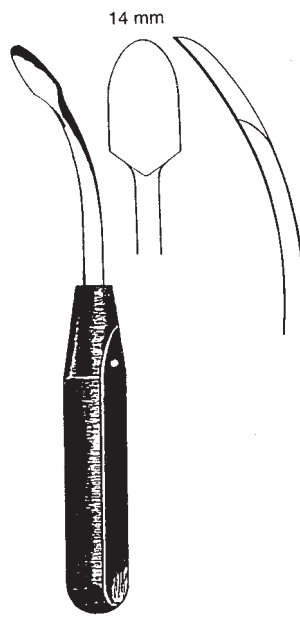

33747-18  
 18,5 cm, 7 1/4"

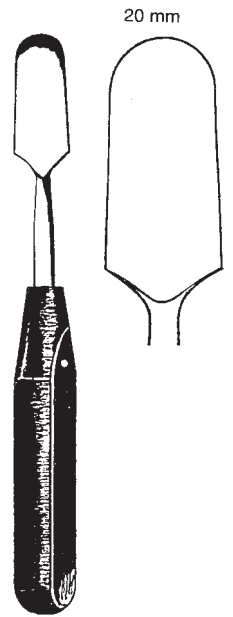

33748-20  
 20 cm, 8"

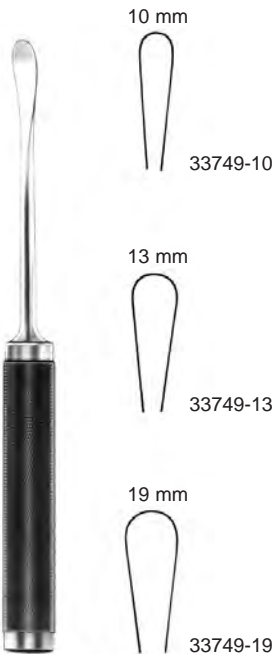

33749-10

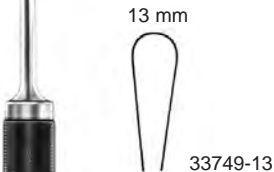

33749-13

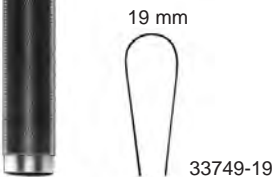

33749-19

COBB  
 28 cm, 11"

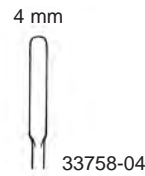

33758-04

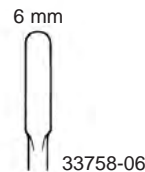

33758-06

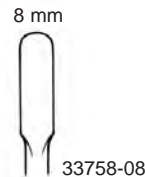

33758-08

COBB  
 27 cm, 10 1/2"

scharf  
sharp  
cortante  
tagliente



SAYRE  
17 cm, 6 <sup>3</sup>/<sub>4</sub>"  
33758-01

stumpf  
blunt  
rombo  
smusso



SAYRE  
17 cm, 6 <sup>3</sup>/<sub>4</sub>"  
33758-02



Elevatoren, Knochenheber  
 Elevators, Bone Levers  
 Elevadores para huesos  
 Elevatori, Elevatori per ossa

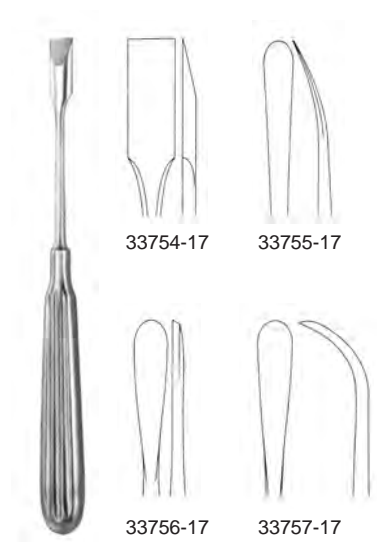

ADSON  
 17 cm, 6 3/4"

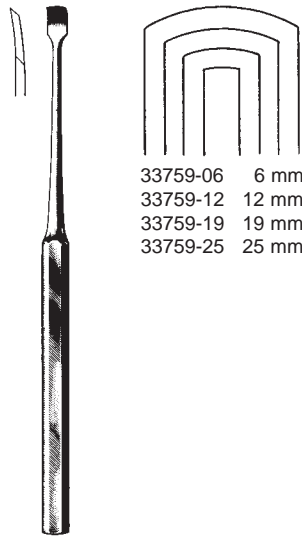

33759-06 6 mm  
 33759-12 12 mm  
 33759-19 19 mm  
 33759-25 25 mm

KEY  
 33759-06 - 33759-25  
 19 cm, 7 1/2"



CHANDLER  
 33763-01 19,0 cm 7 1/2"  
 33763-02 20,3 cm 8"  
 33763-03 22,9 cm 9"  
 33763-04 25,4 cm 10"



CREGO  
 33760-01  
 20 cm, 8"

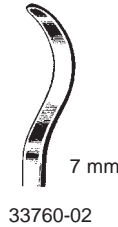

33760-02



33760-03



ALDERDYCE  
 33761-21  
 21 cm, 8 1/4"

Elevatoren, Knochenheber  
Elevators, Bone Levers  
Elevadores para huesos  
Elevatori, Elevatori per ossa

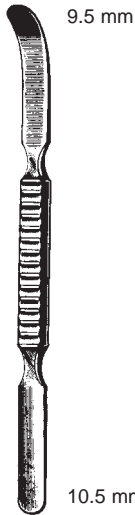

WATSON-CHEYNE  
33765-17  
17,5 cm, 7"

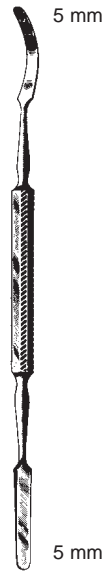

MC DONALD  
33767-19  
19 cm, 7 1/2"



MURPHY-LANE  
33769-30  
30 cm, 11 3/4"



BENNETT  
33771-71  
65x260 mm



BENNETT  
33771-73  
45x260 mm

Knochenhebel  
 Bone Levers  
 Elevadores para huesos  
 Elevatori per ossa

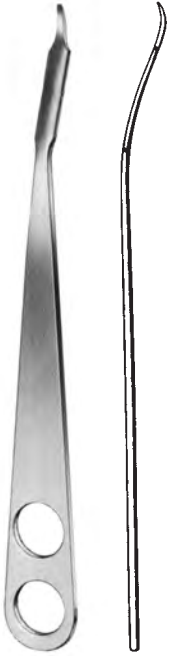

HOHMANN  
 33801-08 8 mm  
 33801-12 12 mm

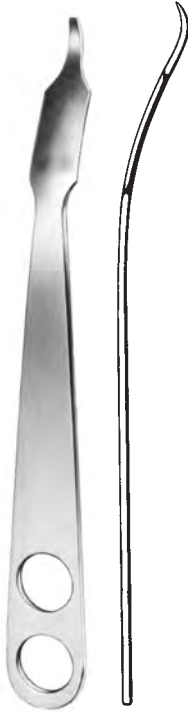

HOHMANN  
 33801-18  
 18 mm, 3/4"

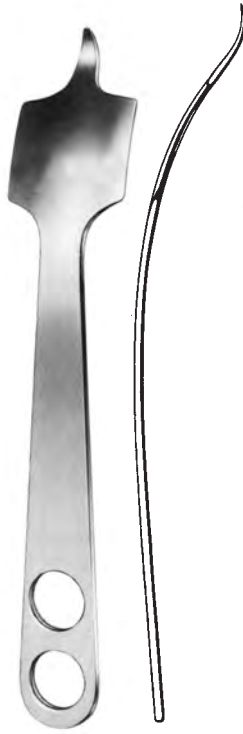

HOHMANN  
 33801-43  
 43 mm, 1 3/4"



HOHMANN  
 33801-70  
 70 mm, 2 3/4"



KÖNIG  
 33802-01  
 15 cm, 6"



KÖNIG  
 33802-02  
 15 cm, 6"



33802-14  
 14 cm, 5 1/2"



33803-05  
 15 cm, 6"



33803-07  
 15 cm, 6"

Knochenheber  
 Bone Levers  
 Elevadores para huesos  
 Elevatori per ossa



HOHMANN  
 33803-43 43 mm

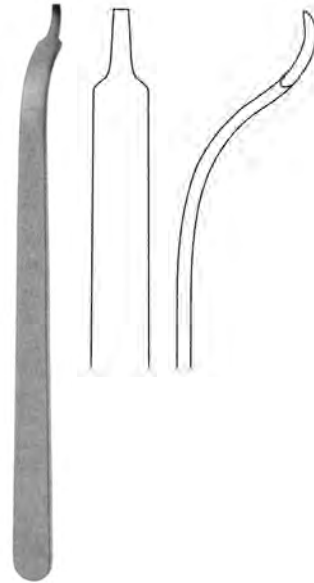

BUCK-GRAMCKO  
 33804-15 15 mm



HOHMANN  
 33805-22 22 mm



HOHMANN  
 33805-33 33 mm



HOHMANN  
 33807-24 24 mm



HOHMANN  
 33809-22 22 mm

Knochenhebel  
Bone Levers  
Elevadores para huesos  
Elevatori per ossa

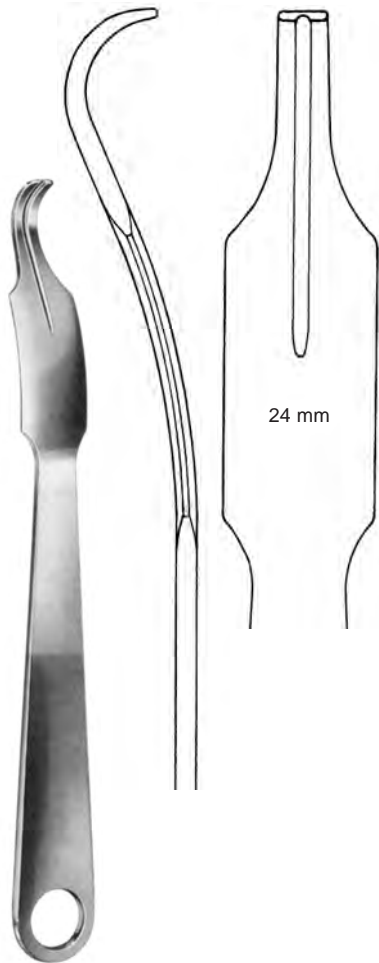

LANGE-HOHMANN  
33810-24  
25 cm, 10"

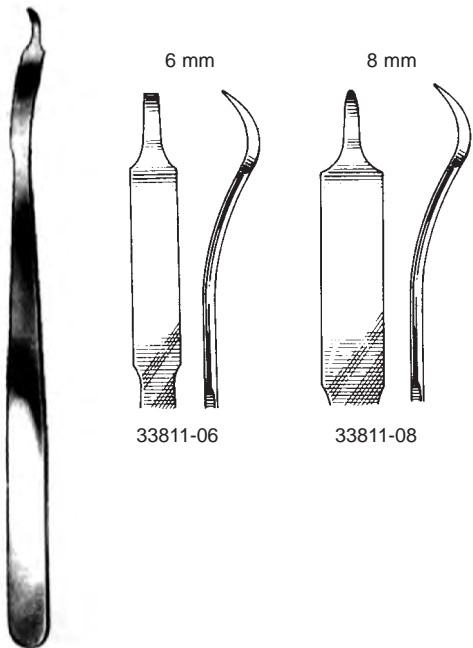

HOHMANN mini  
16 cm, 6 1/4"

Knochenhebel  
Bone Levers  
Elevadores para huesos  
Elevatori per ossa

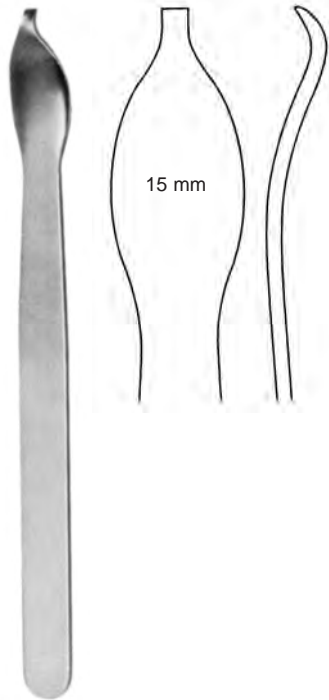

33812-16  
16 cm, 6 1/4"

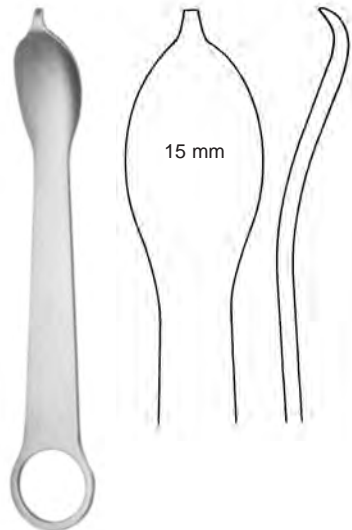

33813-12  
12 cm, 4 3/4"

Knochenhebel  
Bone Levers  
Elevadores para huesos  
Elevatori per ossa

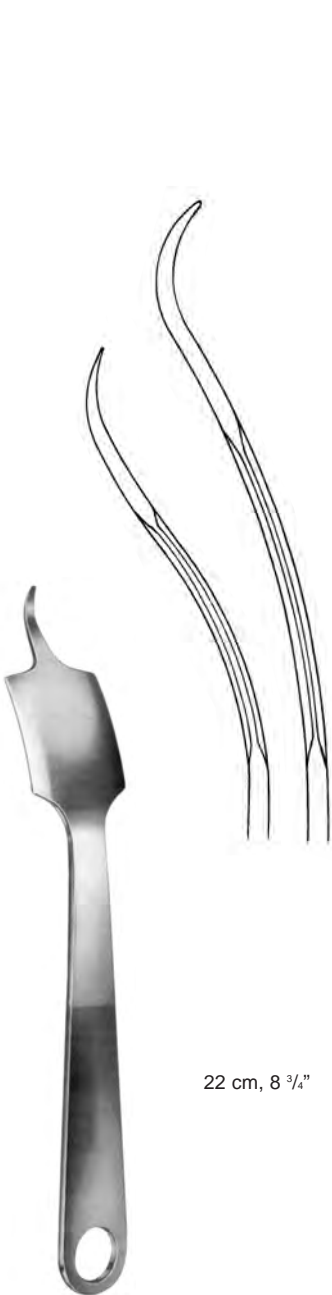

22 cm, 8 3/4"

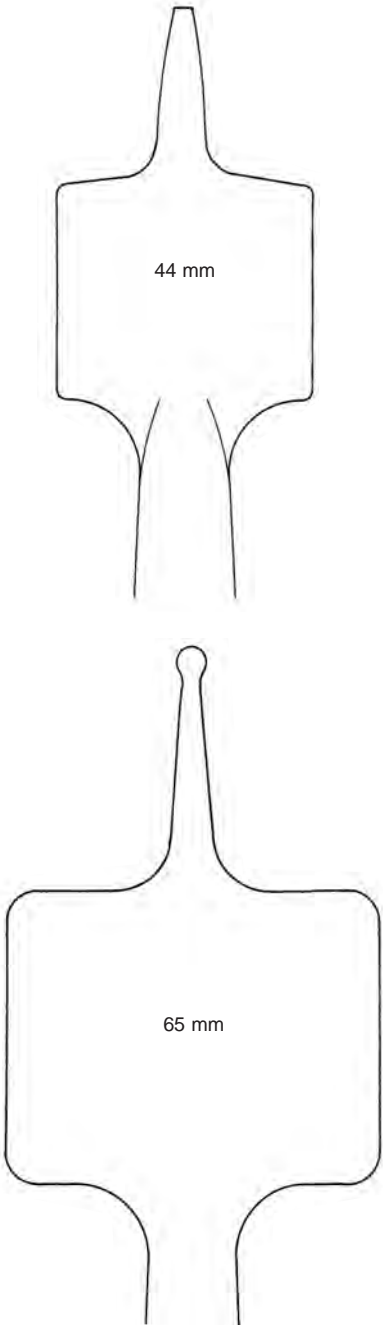

VERBRUGGE-MÜLLER  
33814-44 24,0 cm, 9 1/2"  
33814-65 25,5 cm, 10"





Knochenhebel  
Bone Levers  
Elevadores para huesos  
Elevatori per ossa

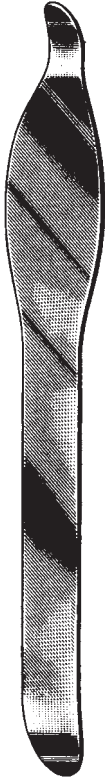

BLOUNT  
33823-26  
26 cm, 10 1/4"

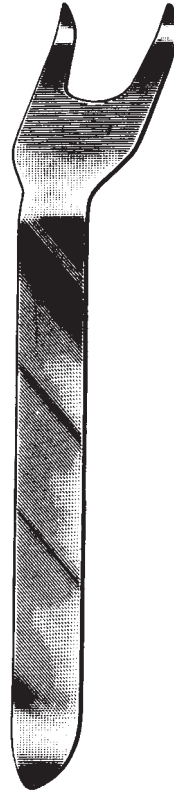

BLOUNT  
33825-26  
26 cm, 10 1/4"

Bauchdeckenhalter, Knochenheber, Meniskushaken  
 Abdominal Retractor, Bone Levers, Meniscus Retractors  
 Separador abdominal, Elevadores p. huesos, Separadores para menisco  
 Divaricatori abdominali, Elevatori per ossa, Divaricatori per il menisco

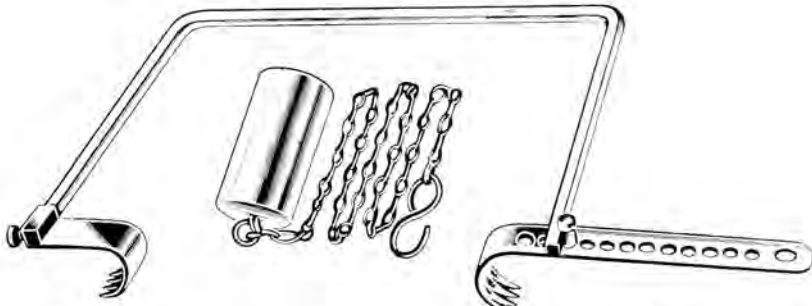

CHARNLEY  
33826-00

33826-01 spitz, gerieft  
pointed tip, serrated  
punta aguda, dentada  
punta acuta, zigrinata

33826-02 stumpf, gerieft  
blunt tip, serrated  
punta roma, dentada  
punta smussa, zigrinata

33826-03 stumpf, glatt  
blunt tip, smooth  
punta roma, lisa  
punta smussa, liscia

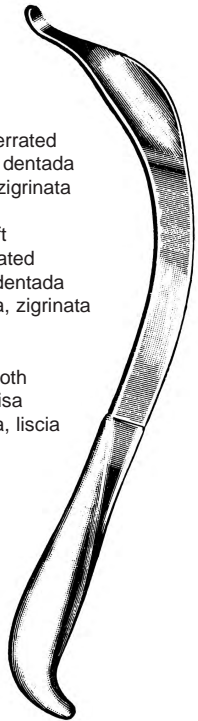

AUFRANC-COBRA  
26 cm 10 1/4"



BLOUNT  
33827-17  
17,5 cm 7"

Knochenhebel  
Bone Levers  
Elevadores p. huesos  
Elevatori per ossa



LANE TRETOWAN  
33828-21  
21,5 cm 8 1/2"



LANE  
33829-25  
25,5 cm 10"



BRISTOW  
33830-23  
23 cm 9"

Knochenheber, Meniskushaken  
Bone Levers, Meniscus Retractors  
Elevadores p. huesos, Separadores para menisco  
Elevatori per ossa, Divaricatori per il menisco

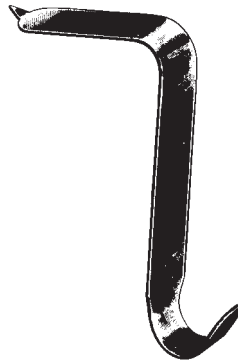

TAYLOR  
16,5 cm, 6 1/2"  
33831-16 75x30 mm  
33833-16 100x30 mm



12 x 13 mm  
33832-01



52 x 13 mm  
33832-02



32 x 19 mm  
33832-03

48 x 19 mm  
33832-04

57 x 19 mm  
33832-05

SMILLIE  
14 cm, 5 1/2"

Sehenschäler, Sehnenfaßspinzette, Sehnenhaltezange, Sehnenfaßinstrumente  
 Tendon seizing instruments  
 Instrumentos para coger tendones  
 Enucleatore di tendine, Strumenti per afferrare tendini



SMILLIE  
 33910-17  
 17 cm, 6 3/4"



33911-17  
 17 cm  
 6 3/4"



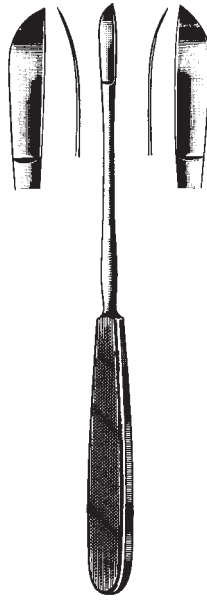

33913-17  
 17 cm  
 6 3/4"



NEFF  
 33921-22 - 33923-22  
 22 cm, 8 3/4"



BUNELL  
 33950-01 - 33950-05  
 15 cm, 6"

	33950-01	3 mm
	33950-02	4 mm
	33950-03	5 mm
	33950-04	6 mm
	33950-05	7 mm



LARSEN  
 33960-15 - 33960-55  
 10 cm, 4"

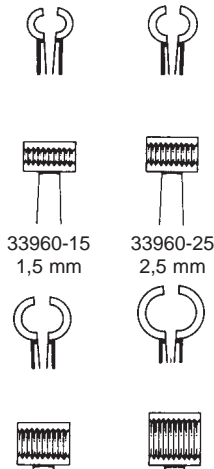

33960-15  
 1,5 mm

33960-25  
 2,5 mm

33960-45  
 4,5 mm

33960-55  
 5,5 mm



JACKSON  
 33961-15  
 15 cm, 6"

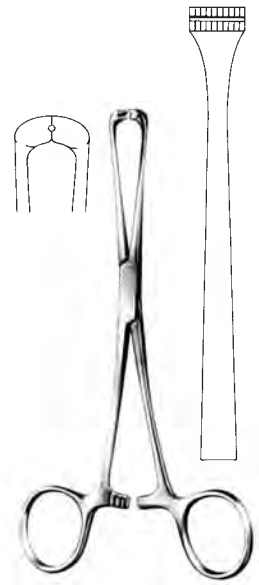

STEINMANN  
 33962-16  
 16 cm, 6 1/4"

Sehnenfaßinstrumente, Sehnenführer  
 Tendon seizing instruments, Tendon passing instr.  
 Instrumentos para coger tendones, Instrumento p. el tunel del tendon  
 Strumenti per afferrare tendini



33963-12  
 12 cm, 4 3/4"



BRAND  
 33964-15 - 33964-24

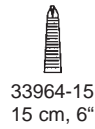

33964-15  
 15 cm, 6"



33964-19  
 19 cm, 7 1/2"



33964-24  
 24 cm, 9 1/2"



BRAND  
 33965-15 15 cm, 6"  
 33965-19 19 cm, 7 1/2"  
 33965-24 24 cm, 9 1/2"



CAROLL  
 33966-11  
 11 cm, 4 3/8"

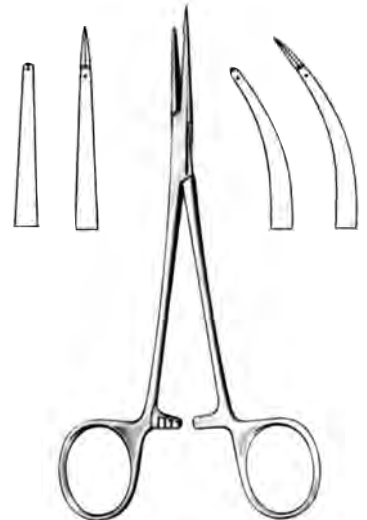

33966-15 15 cm, 6" 33967-15

Sehnenfassinstrumente, Sehnenstripper, Knochenfeilen, Raspeln  
 Tendon seizing instruments, Tendon Strippers, Bone Files, Rasps  
 Instrumentos para coger tendones, Enucleadores de tendones, Limas, Escofinas  
 Strumenti per afferrare tendini, Scollatendini, Lime per ossa, Raspe



KLEINERT-KUTZ  
 33967-20  
 20 cm, 8"



BRAND

ø 3 mm



33968-30  
 30 cm, 11 3/4"

ø 6 mm



33968-60  
 50 cm, 19 1/2"



BUNELL

33969-18 18 cm, 7"  
 33969-23 23 cm, 9"

biegsam  
 malleable  
 maleable  
 malleabile



BUNELL 23 cm

33970-01 ø 4,0 mm  
 33970-02 ø 4,5 mm  
 33970-03 ø 5,5 mm

biegsamer Schaft  
 flexible shaft  
 vastago maleabile  
 camicia flessibile



33971-24  
 24,5 cm, 9 3/4"



33972-22  
 22 cm, 8 3/4"



PUTTI  
 33973-27  
 27 cm, 10 1/2"



PUTTI  
 33975-30  
 30 cm, 11 3/4"

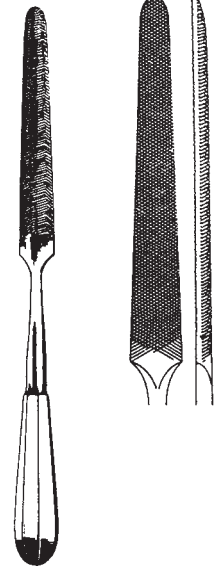

33977-28  
 28 cm, 11"

Komprimeter  
Pneumatic Tourniquet  
Torniquete pneumático  
Apparecchio di compressione



34101-01  
compl.

Gerät zur Erzeugung von Blutleere in den Gliedmaßen  
Compression Apparatus for producing blood vacuum in limbs  
Aparato de compresión para producir el vacío de sangre en los miembros  
Vacumentro per determinare vuoti di sangue nelle membra

34101-02  
Pumpe  
Air Pump  
Bomba de aire  
Pompa di aria

34101-03  
Manometer  
Manometer  
Manómetro  
Manometro

34101-04  
Oberarmmanschette  
Cuff for upper arm  
Bracciale (brazo)  
Bracciale  
34101-06 incl.

34101-05  
Oberschenkelmanschette  
Cuff (leg)  
Bracciale (pierna)  
Cosciale  
34101-07 incl.

34101-06  
Polster für Oberarmmanschette 46 x 6 cm (18" x 2.4")  
Bandage cuff for arm 46 x 6 cm (18" x 2.4")  
Bracciale para brazo 46 x 6 cm (18" x 2.4")  
Bracciale per braccio superiore 46 x 6 cm (18" x 2.4")

34101-07  
Polster für Oberschenkelmanschette 55 x 10 cm (21 1/2 x 10")  
Bandage cuff for leg 55 x 10 cm (21 1/2 x 10")  
Bracciale para el fémur 55 x 10 cm (21 1/2 x 10")  
Bracciale per coscia superiore 55 x 10 cm (21 1/2 x 10")



Amputations- und Resektionssägen  
 Amputation and Resection Saws  
 Sierras para amputación y resección  
 Seghe per amputazione e resezione

Staubinde  
 Compression bandage  
 Vendaje de compresión  
 Benda per compressione  
 5 m lang / long  
 6 cm breit / wide



ESMARCH  
 34105-01

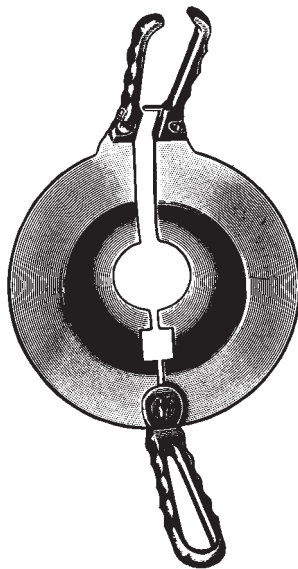

PERCY  
 34110-00



CHARRIERE  
 34112-00

34112-01  
 12 mm

Ersatzsägeblätter  
 Spare saw blades  
 Hojas de sierra de  
 repuesto  
 Lame di ricambio

34112-02  
 15 mm

Ersatzsägeblätter  
 Spare saw blades  
 Hojas de sierra de  
 repuesto  
 Lame di ricambio

komplett mit 2 Blättern  
 complete with 2 blades  
 completo con 2 hojas  
 completa con 2 lame



mit 3 Sägeblätter  
 4 - 6 - 8 mm  
 con 3 hojas de repuesto  
 with 3 spare blade  
 con 3 lame di ricambio

BIER  
 34114-39  
 40,5 cm, 16"



CHARRIERE  
 34116-30  
 30 cm, 11 3/4"

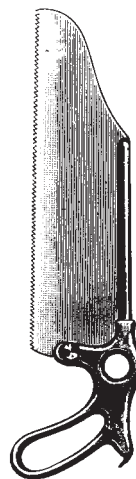

SATTERLEE  
 34118-31  
 31 cm, 12 1/4"



LANGENBECK  
 34120-23  
 23 cm, 9"

Nagelausreißzange, Fingerringsägen  
 Fcps. f. tearing out finger nails, Finger Ring Saws  
 Pinzas para arrancar uñas, Sierras para abrir anillos  
 Pinze per lacerazione delle unghie, Seghe per anelli

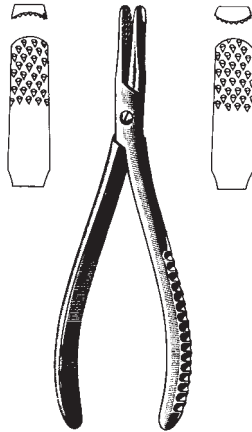

RADOLF

34161-13 13,5 cm, 5 1/4" 3 mm

34162-13 13,5 cm, 5 1/4" 6 mm

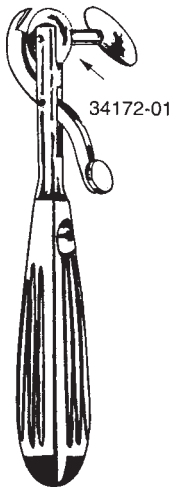

WALTON  
 34172-00

Sägeblatt  
 Saw blade  
 Hoja de sierra  
 Lama di ricambio



REDA  
 34175-00

Sägeblatt  
 Saw blade  
 Hoja de sierra  
 Lama di ricambio

Bohrapparate  
 Bone Hand Drills  
 Perforador de mano  
 Perforatori a mano

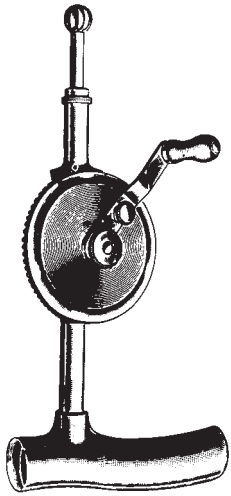

STILLE  
 34210-20 20 cm, 8"  
 compl. incl. 34212-25 - 34214-16

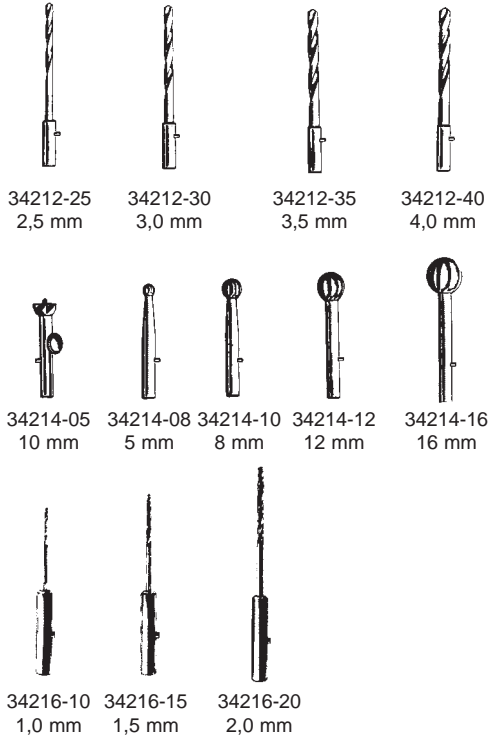

STILLE-SHERMAN  
 34220-24 24 cm, 9 1/2"  
 compl. incl. 34222-25 - 34222-35



MOORE  
 34230-28 28 cm, 11"  
 compl. incl. 34232-00

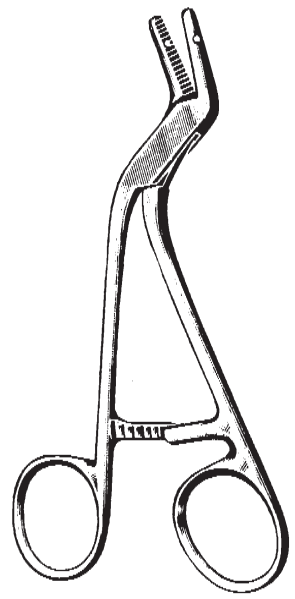

ADSON  
 34231-15 15 cm, 6"

Bohrapparate  
Bone Hand Drills  
Perforador de mano  
Perforatori a mano



34241-00  
Griff allein  
Handle only  
Mango solo  
Manico solo

HUDSON

34240-27 27 cm, 10 1/2"  
compl. incl. 34242-09, -14, -16, -22,  
34246-00



34242-09  
9 mm



34242-14  
14 mm



34242-16  
16 mm



34242-22  
22 mm



ø 2 mm  
34243-02



CUSHING  
34244-10  
34244-14  
34244-16



ERRICO  
34244-17  
ø 16 mm



MC KENZIE  
34248-00  
ø 13 mm



34246-00  
Verlängerungsstück  
Extension piece  
Pieza alargadera  
Giunto di prolungamento



KIRSCHNER  
34250-00 compl.



34252-00



34270-01  
Schlüssel  
Wrench  
Llave  
Chiave

BUNELL  
34270-00 16 cm, 6 1/4"

Bohrapparat 16 cm (6 1/4"), längsdurchbohrt mit Dreibackenspannfutter und Schlüssel, Spannweite bis 4 mm  
Hand drill, 16 cm (6 1/4"), longitudinally bored, with three-jaw-chuck and key, opening up to 4 mm  
Perforador manual, 16 cm (6 1/4"), taladrado longitudinalmente, con mandril de tres mordazas y llave, abriendo hasta 4 mm  
Perforatore a mano, 16 cm (6 1/4"), con perforazione assiale, con mandrino a tre ganasce e chiave, apertura fino a 4 mm di D.

Bohrapparate, Handgriffe  
 Bone Hand Drills, Handles  
 Perforador de mano  
 Perforatori a mano, manici



RALK  
 34280-00



REDA  
 34290-00



34295-00

Spannschlüssel allein  
 Key only  
 Llave suelta  
 Chiave solo



34296-00

Handgriff mit Jacobs-  
 spannfutter und  
 Spannschlüssel  
 Handle with Jacobs chuck  
 and key  
 Mango con cierre Jacobs,  
 de 3 mordazas y llave  
 Manico con mandrino di  
 Jacobs e chiave

Bohrapparat mit Leichtmetallgehäuse, mit Dreibackenspannfutter und Schlüssel, Spannweite bis D. 6,35 mm  
 Hand drill with light metal case, with three-jaw-chuck and key, opening up to D. 6,35 mm  
 Perforador manual con caja de aluminio, con mandril de tres mordazas y llave, abriendo hasta 6,35 mm de D.  
 Perforatore a mano con cassa in metallo leggero, con mandrino a tre ganasce e chiave, apertura fino a 6,35 mm di D.

Handbohrapparat mit umstellbarem Handgriff, mit Jacobs Dreibackenspannfutter und Schlüssel  
 Hand drill with adjustable handle, with Jacobs three-jaw-chuck and wrench  
 Perforador de mano en T con cierre Jacobs de 3 mordazas y llave de ajuste  
 Perforatore a mano con manico regolabile, con mandrino a tre ganasce di Jacobs e chiave



34296-05

T-Handgriff, verriegelbares schlüsselloses Dreibackenspannfutter, rostfrei  
 T-handle, keyless locking chuck  
 Mango en T, mordaza sin llave, inox.  
 Chiave a T con mandrino a tre ganasce inox



34296-10

Handgriff, Dreibackenspannfutter, inkl. Spannschlüssel rostfrei  
 Handle with chuck, including key  
 Mango, mordaza incluyendo llave, inox.  
 Mandrino a tre ganasce con manico retto completo di chiave di arresto inox



34296-15

"Hudson" T-Handgriff, Schnellkupplung  
 Hudson T-handle with fast gripping chuck  
 Mango en T, acople rápido  
 Hudson: mandrino con manico a T  
 Ganasce con raccordo rapido



34296-20

Schnellkupplungs T-Handgriff, groß  
 T-handle with fast gripping chuck, large  
 Mango en T, acople rápido, grande  
 Mandrino a T manico grande  
 Raccordo rapido

Schnellkupplungs-Handgriffe, Bohrapparat elektr.  
Handles with quick action chuck, Bone drill electr.  
Perforador electrico y mangos de acople rápido  
Manici con attachi rapidi, Perforatori elettr.



34296-25  
Schnellkupplungs-T-Handgriff  
T-Handle, quick-action  
Mango en T, acople rápido  
Mandrino a T con raccordo rapido



34296-30  
Schnellkupplungs-Handgriff  
groß mit Hartgewebegriff  
Handle, quick-action, large,  
handle made of very hard fibre  
Mango de acople rápido,  
grande, de material extraduro  
Mandrino grande rapido con  
manico a fibre dure



34296-35  
Schnellkupplungs-Handgriff  
mit Hartgewebegriff  
Handle, quick-action,  
made of very hard fibre  
Mango de acople rápido,  
de material extra-duro  
Mandrino medio rapido con  
manico a fibre dure



34296-40  
Mini Schnellkupplungs-Handgriff  
für „Dental“-Anschluß  
Mini-Handle, quick-action,  
"dental"  
Mini-Mango de acople rápido  
"dental"  
Mini mandrino-rapido con  
impugnatura cilindrica con  
attacco dentale

Bohrer  
 Drill bits  
 Taladros  
 Perforatore



Ø		
1,0 mm	56 mm	34320-10
1,5 mm	70 mm	34320-15
2,0 mm	85 mm	34320-20
2,5 mm	95 mm	34320-25
2,7 mm	100 mm	34320-27
3,0 mm	100 mm	34320-30
3,2 mm	106 mm	34320-32
3,5 mm	112 mm	34320-35
4,0 mm	119 mm	34320-40
4,5 mm	126 mm	34320-45
5,0 mm	132 mm	34320-50
6,0 mm	139 mm	34320-60
7,0 mm	156 mm	34320-70

Spiralbohrer mit Glattschaft  
 Twist Drills with round end  
 Taladros espirales con vástago redondo  
 Perforatore elicoidale



Ø		
1,0 mm	180 mm	34321-10
1,5 mm	180 mm	34321-15
2,0 mm	180 mm	34321-20
2,5 mm	180 mm	34321-25
2,7 mm	180 mm	34321-27
3,0 mm	180 mm	34321-30
3,2 mm	180 mm	34321-32
3,5 mm	180 mm	34321-35
4,0 mm	180 mm	34321-40
4,5 mm	180 mm	34321-45
5,0 mm	180 mm	34321-50
6,0 mm	180 mm	34321-60
6,5 mm	180 mm	34321-65
7,0 mm	180 mm	34321-70
8,0 mm	180 mm	34321-80
9,0 mm	180 mm	34321-90
10,0 mm	180 mm	34322-00

Spiralbohrer mit Glattschaft langes Modell  
 Twist Drills, long typ  
 Taladros espirales, largos  
 Perforatore elicoidale, modello lungo



Ø		
1,1 mm	60 mm	34322-11
1,5 mm	85 mm	34322-15
2,0 mm	100 mm	34322-20
2,5 mm	110 mm	34322-25
2,7 mm	100 mm	34322-27
3,2 mm	145 mm	34322-32
3,5 mm	110 mm	34322-35
4,5 mm	145 mm	34322-45

Spiralbohrer mit Schnellkupplungs-Ansatz  
 Twist Drills, quick-action  
 Taladros espirales, acople rápido  
 Perforatore elicoidale con attacco rapido





Pfrieme, Reibahle  
Awl, Reamer  
Escariadores  
Lesine, Punteruoli



34392-14  
14 cm, 5 1/2"



PERTHES  
34393-18  
18 cm, 7"

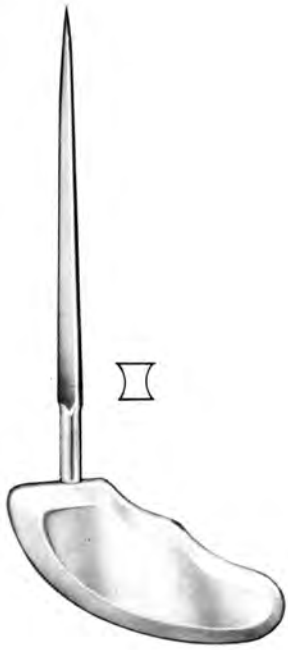

PERTHES  
34393-21  
21 cm, 8 1/4"



34394-14  
14 cm, 5 1/2"

Faßpinzette, Bohrdrachtspender  
Grasping forceps, Support for sterilisation  
Pinzas para coger, Soporte de esterilización  
Pinze per afferrare, Supporto per la sterilizzazione



34439-00

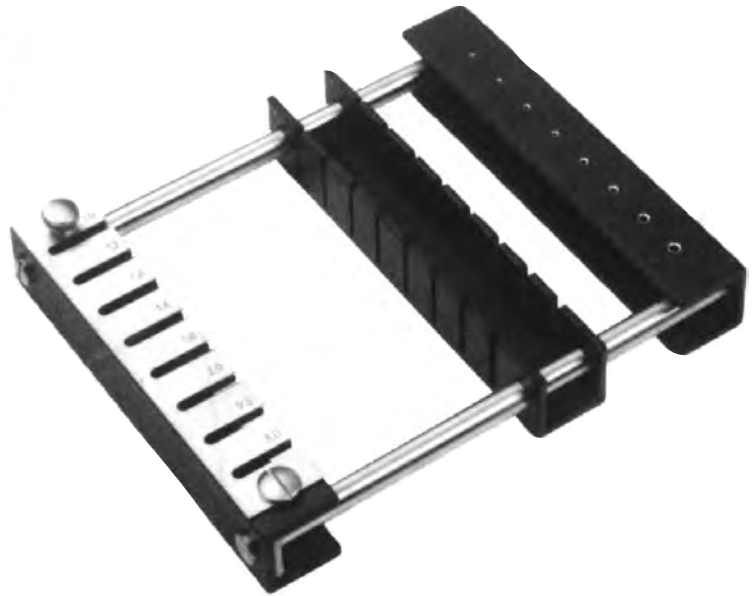

Bohrdrahtspender für Kirschner-Drähte  
Support for sterilisation of Kirschner wires  
Soporte de esterilización p. alambres de Kirschner  
Supporto per la sterilizzazione dei fili di Kirschner

34440-01 bis 15 cm – up to 15 cm (6") – hasta 15 cm – fino a 15 cm  
34440-02 bis 31 cm – up to 31 cm (12 1/4") – hasta 31 cm – fino a 31 cm  
34440-03 bis 10 cm – up to 10 cm (4") – hasta 10 cm – fino a 10 cm

Bohrdrähte  
Drill Wires  
Alambres  
Perforatori filiformi

lieferbar in Packungen à 10 Stück  
available in packages of 10 pieces  
disponible en paquets de 10 unidades  
disponibili solo in confezioni da 10 pezzi

Trokarspitze / Trocar point  
Punta trocar / Punte trequarti



Ø	10 cm, 4"	15 cm, 6"	31 cm, 12 1/4"
0,8	34401-08	34402-08	34403-08
1,0	34401-10	34402-10	34403-10
1,1	34401-11	34402-11	34403-11
1,2	34401-12	34402-12	34403-12
1,3	34401-13	34402-13	34403-13
1,4	34401-14	34402-14	34403-14
1,5	34401-15	34402-15	34403-15
1,6	34401-16	34402-16	34403-16
1,7	34401-17	34402-17	34403-17
1,8	34401-18	34402-18	34403-18
1,9	34401-19	34402-19	34403-19
2,0	34401-20	34402-20	34403-20
2,2	34401-22	34402-22	34403-22
2,3	34401-23	34402-23	34403-23
2,4	34401-24	34402-24	34403-24
2,5	34401-25	34402-25	34403-25
2,8	34401-28	34402-28	34403-28
3,0	34401-30	34402-30	34403-30

Kirschner  
mit rundem Ende / with round shaft  
con extremo redondo / con extremo rotondo

Trokarspitze / Trocar point  
Punta trocar / Punte trequarti



Ø	10 cm, 4"	15 cm, 6"	31 cm, 12 1/4"
0,8	34404-08	34405-08	34406-08
0,9	34404-09	34405-09	34406-09
1,0	34404-10	34405-10	34406-10
1,1	34404-11	34405-11	34406-11
1,2	34404-12	34405-12	34406-12
1,3	34404-13	34405-13	34406-13
1,4	34404-14	34405-14	34406-14
1,5	34404-15	34405-15	34406-15
1,6	34404-16	34405-16	34406-16
1,7	34404-17	34405-17	34406-17
1,8	34404-18	34405-18	34406-18
1,9	34404-19	34405-19	34406-19
2,0	34404-20	34405-20	34406-20
2,2	34404-22	34405-22	34406-22
2,3	34404-23	34405-23	34406-23
2,4	34404-24	34405-24	34406-24
2,5	34404-25	34405-25	34406-25
2,8	34404-28	34405-28	34406-28
3,0	34404-30	34405-30	34406-30

Kirschner  
mit flachem Ende / with flat shaft  
con extremo plano / con extremo piatto

Trokarspitze / Trocar point  
Punta trocar / Punte trequarti



Ø	10 cm, 4"	15 cm, 6"	31 cm, 12 1/4"
0,8	34407-08	34408-08	34409-08
0,9	34407-09	34408-09	34409-09
1,0	34407-10	34408-10	34409-10
1,1	34407-11	34408-11	34409-11
1,2	34407-12	34408-12	34409-12
1,3	34407-13	34408-13	34409-13
1,4	34407-14	34408-14	34409-14
1,5	34407-15	34408-15	34409-15
1,6	34407-16	34408-16	34409-16
1,7	34407-17	34408-17	34409-17
1,8	34407-18	34408-18	34409-18
1,9	34407-19	34408-19	34409-19
2,0	34407-20	34408-20	34409-20
2,2	34407-22	34408-22	34409-22
2,3	34407-23	34408-23	34409-23
2,4	34407-24	34408-24	34409-24
2,5	34407-25	34408-25	34409-25
2,8	34407-28	34408-28	34409-28
3,0	34407-30	34408-30	34409-30

Kirschner  
Trokarende / Trocar shaft  
Punta trocar / Punte trequarti Bilaterali

Lanzenspitze / Lance point  
Punta lanceolar / Punte lanceolata



Ø	31 cm, 12 1/4"
0,8	34410-08
0,9	34410-09
1,0	34410-10
1,1	34410-11
1,2	34410-12
1,3	34410-13
1,4	34410-14
1,5	34410-15
1,6	34410-16
1,7	34410-17
1,8	34410-18
1,9	34410-19
2,0	34410-20
2,2	34410-22
2,3	34410-23
2,4	34410-24
2,5	34410-25
2,8	34410-28
3,0	34410-30

Kirschner  
mit flachem Ende / with flat shaft  
con extremo plano / con extremo piatto

lieferbar in Packungen à 10 Stück  
available in packages of 10 pieces  
disponible en paquets de 10 unidades  
disponibili solo in confezioni da 10 pezzi

Bohrdrähte, Knochennägel  
Drill Wires, Fracture pins  
Alambres, Clavos para huesos  
Perforatori filiformi, Chiodi per ossa

Lanzenspitze / Lance point  
Punta lanceolar / Punta lanceolata



Ø	31 cm, 12 1/4"
0,8	34411-08
0,9	34411-09
1,0	34411-10
1,1	34411-11
1,2	34411-12
1,3	34411-13
1,4	34411-14
1,5	34411-15
1,6	34411-16
1,7	34411-17
1,8	34411-18
1,9	34411-19
2,0	34411-20
2,2	34411-22
2,3	34411-23
2,4	34411-24
2,5	34411-25
2,8	34411-28
3,0	34411-30

Trokarspitze / Trocar point  
Punta trocar / Punta trequarti



	Ø	Ø	Ø	Ø	Ø	Ø	Ø
	3,5 mm	4,0 mm	4,5 mm	4,8 mm	5,0 mm	5,5 mm	6,0 mm
8 cm, 3 1/8"	34412-08	34413-08	34415-08	34416-08	34417-08	34418-08	34419-08
10 cm, 4"	34412-10	34413-10	34415-10	34416-10	34417-10	34418-10	34419-10
12 cm, 4 3/4"	34412-12	34413-12	34415-12	34416-12	34417-12	34418-12	34419-12
14 cm, 5 1/2"	34412-14	34413-14	34415-14	34416-14	34417-14	34418-14	34419-14
16 cm, 6 1/4"	34412-16	34413-16	34415-16	34416-16	34417-16	34418-16	34419-16
18 cm, 7"	34412-18	34413-18	34415-18	34416-18	34417-18	34418-18	34419-18
20 cm, 8"	34412-20	34413-20	34415-20	34416-20	34417-20	34418-20	34419-20
22 cm, 8 3/4"	34412-22	34413-22	34415-22	34416-22	34417-22	34418-22	34419-22
23 cm, 9"	34412-23	34413-23	34415-23	34416-23	34417-23	34418-23	34419-23
24 cm, 9 1/2"	34412-24	34413-24	34415-24	34416-24	34417-24	34418-24	34419-24
26 cm, 10 1/4"	34412-26	34413-26	34415-26	34416-26	34417-26	34418-26	34419-26
28 cm, 11"	34412-28	34413-28	34415-28	34416-28	34417-28	34418-28	34419-28
30 cm, 11 3/4"	34412-30	34413-30	34415-30	34416-30	34417-30	34418-30	34419-30

Kirschner  
mit rundem Ende / with round shaft  
con extremo redondo / con extremo rotondo

Steinmann  
mit rundem Ende / with round shaft  
con extremo redondo / con extremo rotondo

Trokarspitze / Trocar point  
Punta trocar / Punta trequarti



	Ø	Ø	Ø	Ø	Ø	Ø	Ø	Ø
	3,5 mm	4,0 mm	4,2 mm	4,5 mm	4,8 mm	5,0 mm	5,5 mm	6,0 mm
8 cm, 3 1/8"	34420-08	34421-08	34422-08	34423-08	34424-08	34425-08	34426-08	34427-08
10 cm, 4"	34420-10	34421-10	34422-10	34423-10	34424-10	34425-10	34426-10	34427-10
12 cm, 4 3/4"	34420-12	34421-12	34422-12	34423-12	34424-12	34425-12	34426-12	34427-12
14 cm, 5 1/2"	34420-14	34421-14	34422-14	34423-14	34424-14	34425-14	34426-14	34427-14
16 cm, 6 1/4"	34420-16	34421-16	34422-16	34423-16	34424-16	34425-16	34426-16	34427-16
18 cm, 7"	34420-18	34421-18	34422-18	34423-18	34424-18	34425-18	34426-18	34427-18
20 cm, 8"	34420-20	34421-20	34422-20	34423-20	34424-20	34425-20	34426-20	34427-20
22 cm, 8 3/4"	34420-22	34421-22	34422-22	34423-22	34424-22	34425-22	34426-22	34427-22
23 cm, 9"	34420-23	34421-23	34422-23	34423-23	34424-23	34425-23	34426-23	34427-23
24 cm, 9 1/2"	34420-24	34421-24	34422-24	34423-24	34424-24	34425-24	34426-24	34427-24
26 cm, 10 1/4"	34420-26	34421-26	34422-26	34423-26	34424-26	34425-26	34426-26	34427-26
28 cm, 11"	34420-28	34421-28	34422-28	34423-28	34424-28	34425-28	34426-28	34427-28
30 cm, 11 3/4"	34420-30	34421-30	34422-30	34423-30	34424-30	34425-30	34426-30	34427-30

Steinmann  
Trokarende / Trocar shaft  
Punta trocar / Punta trequarti Bilateralis

Knochennägel  
Fracture pins  
Clavos para huesos  
Chiodi per ossa

lieferbar in Packungen à 10 Stück  
available in packages of 10 pieces  
disponible en paquets de 10 unidades  
disponibili solo in confezioni da 10 pezzi

Trokarspitze / Trocar point  
Punta trocar / Punta trequarti



	Ø	Ø	Ø	Ø	Ø	Ø	Ø	Ø
8 cm, 3 1/8"	3,5 mm	4,0 mm	4,2 mm	4,5 mm	4,8 mm	5,0 mm	5,5 mm	6,0 mm
10 cm, 4"	34428-10	34429-10	34430-10	34431-10	34432-10	34433-10	34434-10	34435-10
12 cm, 4 3/4"	34428-12	34429-12	34430-12	34431-12	34432-12	34433-12	34434-12	34435-12
14 cm, 5 1/2"	34428-14	34429-14	34430-14	34431-14	34432-14	34433-14	34434-14	34435-14
16 cm, 6 1/4"	34428-16	34429-16	34430-16	34431-16	34432-16	34433-16	34434-16	34435-16
18 cm, 7"	34428-18	34429-18	34430-18	34431-18	34432-18	34433-18	34434-18	34435-18
20 cm, 8"	34428-20	34429-20	34430-20	34431-20	34432-20	34433-20	34434-20	34435-20
22 cm, 8 3/4"	34428-22	34429-22	34430-22	34431-22	34432-22	34433-22	34434-22	34435-22
23 cm, 9"	34428-23	34429-23	34430-23	34431-23	34432-23	34433-23	34434-23	34435-23
24 cm, 9 1/2"	34428-24	34429-24	34430-24	34431-24	34432-24	34433-24	34434-24	34435-24
26 cm, 10 1/4"	34428-26	34429-26	34430-26	34431-26	34432-26	34433-26	34434-26	34435-26
28 cm, 11"	34428-28	34429-28	34430-28	34431-28	34432-28	34433-28	34434-28	34435-28
30 cm, 11 3/4"	34428-30	34429-30	34430-30	34431-30	34432-30	34433-30	34434-30	34435-30

Steinmann  
mit 3-kant-Ende / with triangular end  
con extremo triangular / con estremo triangolare

Trokarspitze / Trocar point  
Punta trocar / Punta trequarti

mit Gewinde  
threaded Wires  
con rosca  
con filetto



	Ø	15 cm, 6"	18 cm, 7"	20 cm, 8"	23 cm, 9"	25 cm, 10"	31 cm, 12 1/4"
1,2	34436-12	34437-12	34438-12	34439-12	34440-12	34441-12	34441-12
1,4	34436-14	34437-14	34438-14	34439-14	34440-14	34441-14	34441-14
1,6	34436-16	34437-16	34438-16	34439-16	34440-16	34441-16	34441-16
1,8	34436-18	34437-18	34438-18	34439-18	34440-18	34441-18	34441-18
2,0	34436-20	34437-20	34438-20	34439-20	34440-20	34441-20	34441-20
2,4	34436-24	34437-24	34438-24	34439-24	34440-24	34441-24	34441-24
2,5	34436-25	34437-25	34438-25	34439-25	34440-25	34441-25	34441-25
2,8	34436-28	34437-28	34438-28	34439-28	34440-28	34441-28	34441-28
3,0	34436-30	34437-30	34438-30	34439-30	34440-30	34441-30	34441-30
3,2	34436-32	34437-32	34438-32	34439-32	34440-32	34441-32	34441-32
3,5	34436-35	34437-35	34438-35	34439-35	34440-35	34441-35	34441-35

mit rundem Ende / with round shaft  
con extremo redondo / con estremo rotondo

lieferbar in Packungen à 10 Stück  
 available in packages of 10 pieces  
 disponible en paquetes de 10 unidades  
 disponibili solo in confezioni da 10 pezzi

Knochennägel  
 Fracture pins  
 Clavos para huesos  
 Chiodi per ossa

Trokarspitze / Trocar point  
 Punta trocar / Punta trequarti

mit Gewinde  
 threaded Wires  
 con rosca  
 con filetto



Ø	15 cm, 6"	18 cm, 7"	20 cm, 8"	23 cm, 9"	25 cm, 10"	31 cm, 12 1/4"
1,2	34442-12	34443-12	34444-12	34445-12	34446-12	34447-12
1,4	34442-14	34443-14	34444-14	34445-14	34446-14	34447-14
1,6	34442-16	34443-16	34444-16	34445-16	34446-16	34447-16
1,8	34442-18	34443-18	34444-18	34445-18	34446-18	34447-18
2,0	34442-20	34443-20	34444-20	34445-20	34446-20	34447-20
2,4	34442-24	34443-24	34444-24	34445-24	34446-24	34447-24
2,5	34442-25	34443-25	34444-25	34445-25	34446-25	34447-25
2,8	34442-28	34443-28	34444-28	34445-28	34446-28	34447-28
3,0	34442-30	34443-30	34444-30	34445-30	34446-30	34447-30
3,2	34442-32	34443-32	34444-32	34445-32	34446-32	34447-32
3,5	34442-35	34443-35	34444-35	34445-35	34446-35	34447-35

Trokarende / Trocar shaft  
 Punta trocar / Punta trequarti

Bohrdrahtspender  
 K-Wire Dispenser  
 Dispensador para brocas filiformes  
 Distributore per fili

12 cm, 4 3/4"



17 cm, 6 3/4"



33 cm, 13"



34450-08 0,8 mm  
 34450-10 1,0 mm  
 34450-12 1,2 mm  
 34450-14 1,4 mm  
 34450-15 1,5 mm  
 34450-18 1,8 mm  
 34450-20 2,0 mm  
 34450-22 2,2 mm  
 34450-25 2,5 mm  
 34450-30 3,0 mm

34460-08 0,8 mm  
 34460-10 1,0 mm  
 34460-12 1,2 mm  
 34460-14 1,4 mm  
 34460-15 1,5 mm  
 34460-16 1,6 mm  
 34460-20 2,0 mm  
 34460-22 2,2 mm  
 34460-25 2,5 mm  
 34460-30 3,0 mm

34470-08 0,8 mm  
 34470-10 1,0 mm  
 34470-12 1,2 mm  
 34470-14 1,4 mm  
 34470-15 1,5 mm  
 34470-16 1,6 mm  
 34470-20 2,0 mm  
 34470-22 2,2 mm  
 34470-25 2,5 mm  
 34470-30 3,0 mm

Fingerschützer, Drahtgeflecht  
Finger Protectors, Wire gauze  
Dedales, Gasa metálica  
Proteggidita, maglia metallica per estensione



34480-01



34480-02



34480-03

LANGENBECK  
34480-01 - 34480-03



34492-01  
klein / small / pequeño / stretto

34492-02  
mittel / medium / mediano / medio

34492-03  
groß / large / grande / grande

34492-01 - 34492-03

sterilisierbar  
sterilizable  
esterilizabile  
sterilizzabile



Extensionsbügel  
 Extension Bows  
 Estribos para extensión  
 Archi per estensione

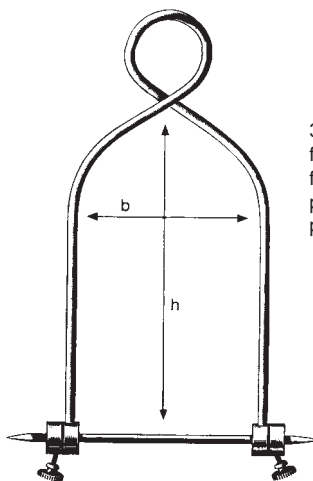

34502-16  
 für Arm  
 for arm  
 para brazo  
 per braccio

16 x 9 cm  
 6 1/4" x 3 1/2"

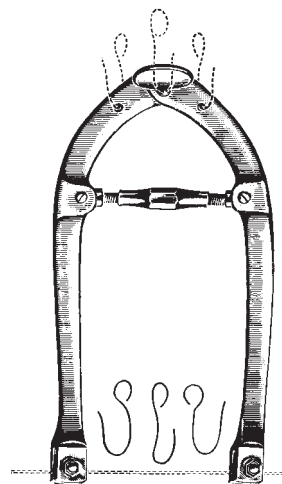

KIRSCHNER

34514-18 40 - 140 mm x 115 mm mit 3 Zughaken  
 with 3 hooks  
 con 3 ganchos  
 con 3 ganci per trazione

34514-27 60 - 220 mm x 175 mm mit 3 Zughaken  
 with 3 hooks  
 con 3 ganchos  
 con 3 ganci per trazione

BÖHLER  
 34502-15 21 x 15 cm 8 1/4" x 6"  
 34502-21 21 x 11 cm 8 1/4" x 4 3/8"  
 für Oberschenkel und Knie  
 for thigh and knee  
 para femur y rodilla  
 per femore e ginocchio

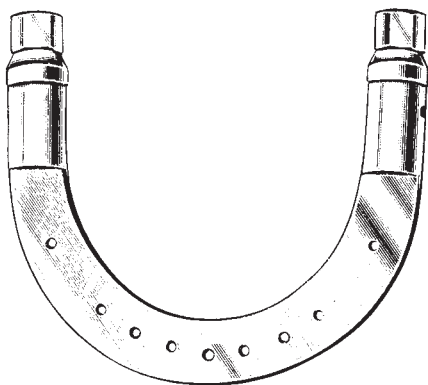

KIRSCHNER

34515-09 9,5 x 7,0 cm 3 3/4" x 2 3/4"  
 34515-10 9,5 x 11,0 cm 3 3/4" x 4 3/8"  
 34515-11 10,5 x 10,0 cm 4.1" x 4"  
 34515-12 12,0 x 12,0 cm 4 3/4" x 4 3/4"  
 34515-13 13,5 x 13,0 cm 5 1/4" x 5 1/8"  
 34515-15 15,5 x 15,5 cm 6" x 6"  
 34515-20 20,0 x 15,5 cm 8" x 6"

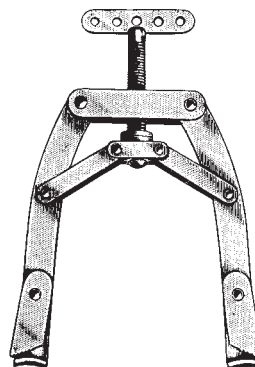

KIRSCHNER U.S.

34518-01  
 mittel, medium, mediano, max. 130 mm (5 1/8")  
 34518-02  
 groß, large, grande, max. 185 mm (7 1/4")  
 34518-03  
 extra groß, large extra long, muy grande, max. 220 mm (8 3/4")

Mutterschlüssel, Spanschlüssel  
Screw nut wrench, Wire strainer  
llave de tuercas, Tensor de taladros, alambres  
Chiave per madreviti, Strumenti tenditore



34515-01

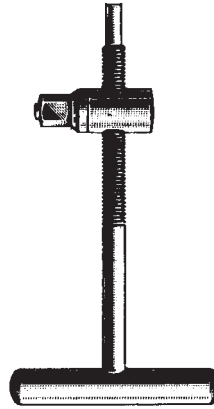

34515-02

Zughaken  
hooks  
ganchos  
ganci per trazione



KIRSCHNER  
34519-01



KIRSCHNER  
34519-02

Knochendraht  
Bone wire  
Hilos para huesos  
Filo per ossa



weich, in Ringen zu 10 m (32,8 Feet)  
soft, in coils of 10 m (32,8 Feet)  
blando, de 10 m (32,8 Feet)  
morbido, 10 m (32,8 Feet)

Material:  
nichtrostender Implantatstahl  
nach DIN 17443 (ISO 5832/1)

	mm Ø
34520-02	0,2
34520-03	0,3
34520-04	0,4
34520-05	0,5
34520-06	0,6
34520-07	0,7
34520-08	0,8
34520-09	0,9
34520-10	1,0
34520-12	1,2
34520-15	1,5

Drahtumföhrungsnaðeln, Drahtspanninstrumente  
 Bone wire guides, Bone wire tighteners  
 Agujas pasa-hilos, Tensor cierra-hilos  
 Aghi passafili, Strumenti tendifili



DEMEL

27 cm, 10 1/2"

Fig. 1 34528-01

Fig. 2 34528-02

Fig. 3 34528-03

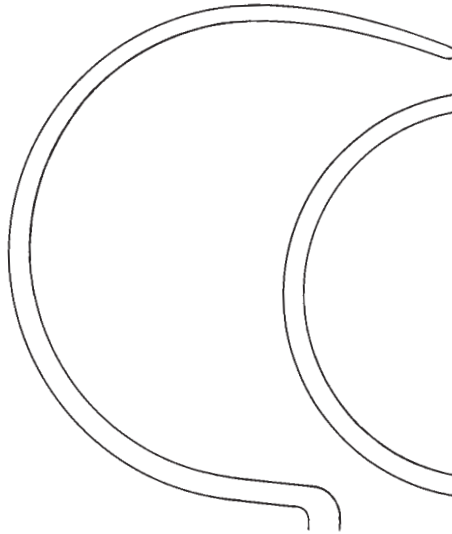

Fig. 1

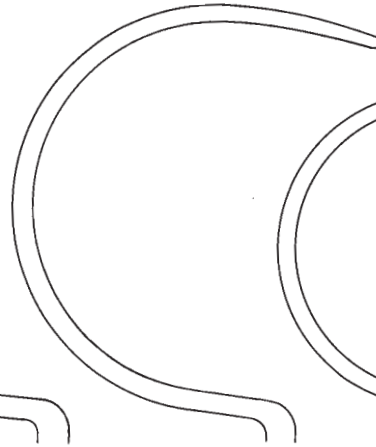

Fig. 2

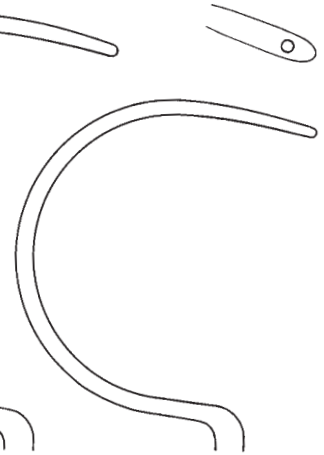
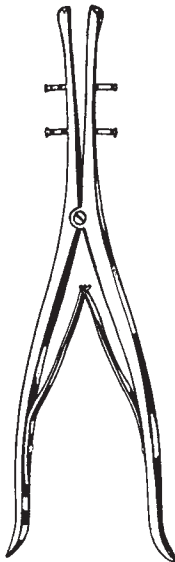
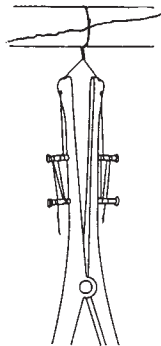

Fig. 3



DEMEL

34530-28 28 cm, 11"



LOUTE

34531-21 21 cm, 8 1/4"

Flachzangen, Faßzangen  
 Flat Nose Pliers, Seizing Forceps  
 Alicates planos, Pinzas para coger alambres  
 Tenaglie piatte, Tenaglie per afferrare



17 cm, 6 3/4"  
 34533-17 INOX



GRIP  
 18 cm, 7"  
 34534-18 INOX



34534-15  
 15 cm, 6"



34535-16  
 16 cm, 6 1/4"

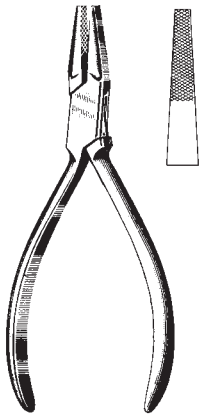

34536-14  
 14 cm, 5 1/2"



34537-19  
 19 cm, 7 1/2"



2 mm

4 mm

6 mm

34538-01

34538-02

34538-03

34539-01 TC 34539-02 TC 34539-03 TC

18 cm, 7"

Flachzangen, Drahtkneifzangen  
 Flat Nose Pliers, Wire cutting Pliers  
 Alicates planos, Alicates para cortar alambres  
 Tenaglie piate, Tenaglie tagliafili



34540-01



34540-02



17 cm, 6 3/4"

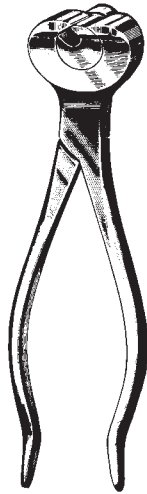

34540-16  
 16 cm, 6 1/4"

soft wire 2,0 mm  
 hard wire 2,0 mm



34540-18  
 18 cm, 7"



34541-23 23 cm, 9"

soft wire 3,0 mm  
 hard wire 2,2 mm

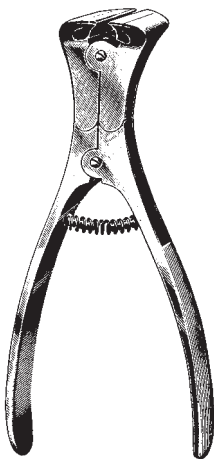

34542-15 TC 15 cm, 6"

Soft wire 2,0 mm  
 hard wire 1,5 mm



34543-23 23 cm, 9"

Soft wire 3,5 mm  
 hard wire 2,5 mm



34544-18 TC 18 cm, 7"

Soft wire 2,5 mm  
 hard wire 1,5 mm

**Drahtkneifzangen, Drahtfaßzangen**  
**Wire Cutting Pliers, Wire Seizing Forceps**  
**Alicates para cortar alambres, Pinzas para coger alambres**  
**Tronchese taglienti, Tenaglie per afferrare i fili**



für harten Draht bis  
2,2 mm Ø  
for hard wires up to  
2,2 mm Ø  
para hilos duros  
hasta 2,2 mm Ø  
per fili duri a  
2,2 mm Ø

für weichen Draht bis  
2,5 mm Ø  
for soft wires up to  
2,5 mm Ø  
para hilos blandos  
hasta 2,5 mm Ø  
per fili dolci fino a  
2,5 mm Ø

**34545-22 TC 22 cm, 10 1/2"**

für harten Draht bis 1,6 mm Ø  
for hard wires up to 1,6 mm Ø  
para hilos duros hasta 1,6 mm Ø  
per fili duri a 1,6 mm Ø

für weichen Draht bis 2,0 mm Ø  
for soft wires up to 2,0 mm Ø  
para hilos blandos hasta 2,0 mm Ø  
per fili dolci fino a 2,0 mm Ø

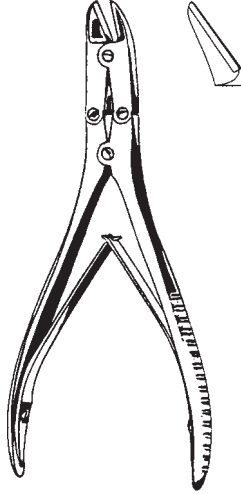

**34546-16 16 cm, 6 1/4"**  
**34546-18 18 cm, 7"**



für weichen Draht bis  
2,0 mm Ø  
for soft wires up to  
2,0 mm Ø  
para hilos blandos  
hasta 2,0 mm Ø  
per fili dolci fino a  
2,0 mm Ø

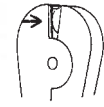

für harten Draht bis  
1,6 mm Ø  
for hard wires up to  
1,6 mm Ø  
para hilos duros  
hasta 1,6 mm Ø  
per fili duri a  
1,6 mm Ø

**34548-18 18 cm, 7"**



soft wire 1,5 mm  
hard wire 1,0 mm

**34549-14 14 cm, 5 1/2"**



**34550-13 13 cm, 5 1/3"**  
**34550-18 18 cm, 7"**

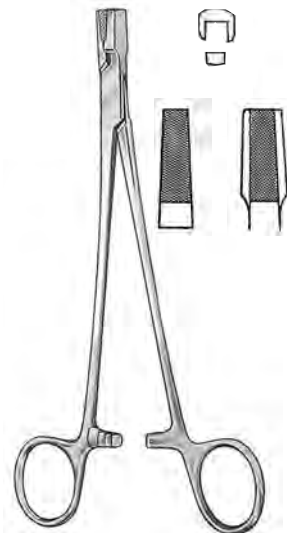

**17 cm, 6 3/4"**  
**34551-17 TC**

Drahtzangen  
Wire Twisting Forceps  
Pinzas para torcer hilos  
Pinza torcifili



CORWIN-HEGAR  
34552-16 TC 16 cm, 6 1/4"



BERRY  
34556-18 TC 18 cm, 7"



MAYO-HABERISSER  
TC

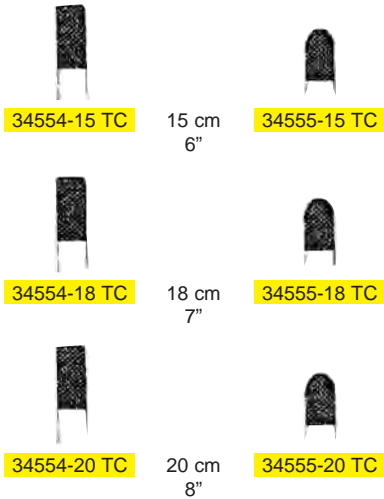



Drahtkneifzange für Draht bis 6 mm Ø  
Pin cutter for pins up to 6 mm  
Alicata para cortar clavos hasta 6 mm  
Ghiottina per tagliare fili fino a 6 mm



34558-32 32 cm, 12 1/2"

bis 2.2 mm  
up to 2.2 mm  
hasta 2.2 mm  
a 2.2 mm



34559-47 47 cm, 18 1/2"

bis 6 mm  
up to 6 mm  
hasta 6 mm  
a 6 mm



34560-57 57 cm 22 1/2"

bis 6.5 mm  
up to 6.5 mm  
hasta 6.5 mm  
a 6.5 mm

Instrumentarium für Ender und Küntscher Nägel  
 Instruments for Ender and Küntscher Nails  
 Instrumental para Clavos Ender y Küntscher  
 Strumentario per chiodi di Ender e Küntscher

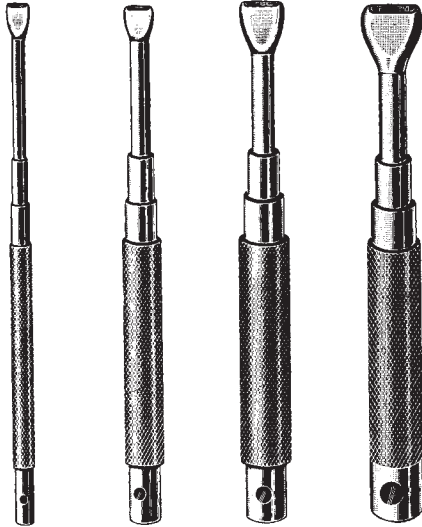

34562-24	34562-32	34562-48	34562-64
f./p. Ø 2,4 mm	3,2 mm	4,8 mm	6,4 mm

Ein- und Ausschlaginstrumente für Ender-Nägel  
 Driver-extractors for Ender nails  
 Impactores-Extractores para clavos de Ender  
 Impattatore-Estrattore per chiodi di Ender

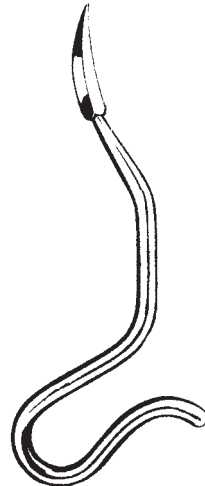

KÜNTSCHER	26 cm, 10 1/4"
34570-01	8 mm
34570-02	10 mm

Vorböhrer zum Öffnen der Markhöhle  
 Reamers for medullary cave  
 Perforadores para la cavidad medular  
 Alesatore per l'apertura del midollo

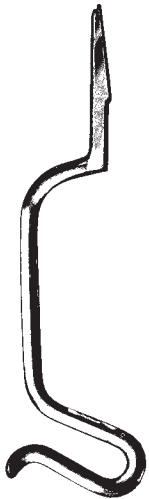

KÜNTSCHER  
 34573-35 35 cm, 13 3/4"  
 Aufreiber für Oberschenkel  
 Reamer for femur  
 Perforador para fémur  
 Alesatore per femore



mm Ø	L = 60 cm, 23 3/4"
3,5	34583-60
4,0	34584-60
5,0	34585-60

Führungsspieße  
 Guide pins  
 Guía-conductora para clavos medulares  
 Guida conduttrice



für Nägel for nails para clavos per chiodi
Ø 6-8 mm 34588-01
Ø 9-12 mm 34588-02
Ø 12-17 mm 34588-03

KÜNTSCHER 19 cm, 7 1/2"  
 Fertigschläger  
 Nail impactors  
 Impactor final  
 Impattatore finale

Instrumentarium für Küntscher Nägel  
 Instruments for Küntscher Nails  
 Instrumental para Clavos Küntscher  
 Strumentario per chiodi di Küntscher

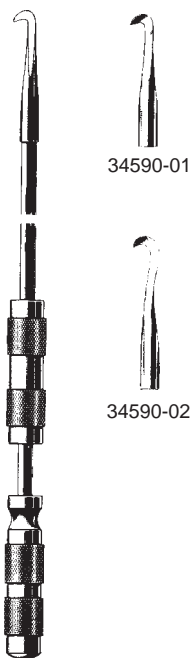

34590-01

34590-02

KÜNTSCHER 63 cm, 24 3/4"  
 34590-00 komplett mit 2 Haken 34590-01/02  
 34590-00 complete with 2 hooks 34590-01/02  
 34590-00 completo con 2 ganchos 34590-01/02  
 34590-00 completo con 2 ganci 34590-01/02



Extraktionshaken  
 Extraction hooks  
 Ganchos extractores  
 Gancio d'estrazione

cm  
 34596-29 29, 11.4"  
 34596-37 37, 14.5"  
 34596-42 42, 16.5"  
 34596-49 49, 19.3"

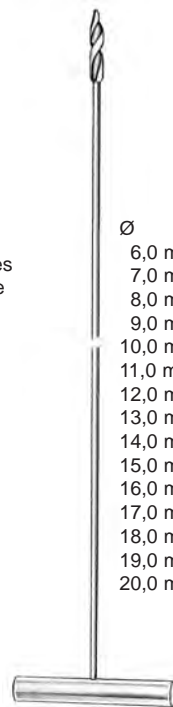

Ø  
 6,0 mm 34597-06  
 7,0 mm 34597-07  
 8,0 mm 34597-08  
 9,0 mm 34597-09  
 10,0 mm 34597-10  
 11,0 mm 34597-11  
 12,0 mm 34597-12  
 13,0 mm 34597-13  
 14,0 mm 34597-14  
 15,0 mm 34597-15  
 16,0 mm 34597-16  
 17,0 mm 34597-17  
 18,0 mm 34597-18  
 19,0 mm 34597-19  
 20,0 mm 34597-20

Markraumborher  
 Intramedullary drills  
 Perforadores medulares  
 Perforatore intramidollare

Extraktor / Nail extractor  
 Aparato extractor / Estrattore



Einschläger / Nail inserter  
 Introductor clavos / Impattatore  
 34612-00



Impactor  
 34613-00



Bender  
 34615-00

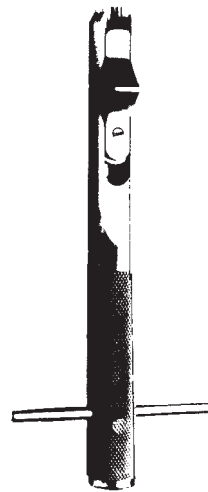

Impactor-Extractor  
 Impattatore-Estrattore  
 34617-00

Schraubenzieher  
Screw Drivers  
Destornilladores  
Cacciaviti



LANE  
34620-25 25 cm, 10"  
Schraubenzieher 6 mm  
Screw Driver 6 mm  
Destornillador 6 mm  
Cacciaviti 6 mm



WILLIAMS  
24 cm  
9 1/2"

3,5 mm



34624-01



34624-02



34624-03



34624-04



mit Ferrozellgriff  
with Ferrozell handle  
con mango de Ferrozell  
con manico di Ferrozell



34628-01  
25 cm  
10"



34628-02  
25 cm  
10"



34629-01  
25 cm  
10"



1,5 mm

34628-15  
20 cm  
8"



2,5 mm

34628-25  
25 cm  
10"



3,5 mm

34628-35  
25 cm  
10"

Schraubenzieher  
Screw Drivers  
Destornilladores  
Cacciaviti



LANE  
34632-25 25 cm, 10"  
Kreuzschlitzschraubenzieher  
Screwdriver for cross slotted head  
Destornillador para tornillos con ranura en cruz  
Cacciavite a croce



Schraubenhaltehülse für Sechskantschrauben  
Screw holder  
Vaina para tornillos  
Guaina per viti esagonali  
34634-25 2,5 mm  
34634-35 3,5 mm

Haltezangen, Biegehebel  
Holding Forceps, Bender  
Pinzas para sostener placas y tornillos, Palanca  
Pinza portaplacca, leva piegaplacche

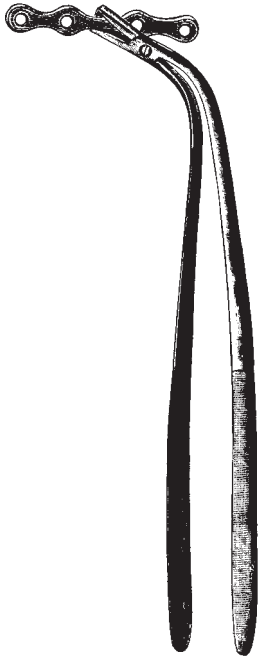

LANE  
34637-23 23 cm, 9"

Knochenplatten-Haltezange  
Plate Holding Forceps  
Pinza para sostener placas  
Pinza portaplacche



LANE  
34639-22 22 cm, 8 3/4"

Schraubenzange  
Screw Holding Forceps  
Pinza para sostener tornillos  
Pinza portaviti

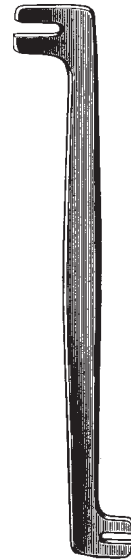

LANE  
34640-18 18 cm, 7"

Biegehebel f. Knochenplatten  
Plate Bender  
Palanca para doblar placas  
Leva piegaplacche

Anlegezangen, Silberklammern  
 Applying Fcps. Clips  
 Pinzas aplicadoras, Grapas  
 Pinza per applicare, Agrafes

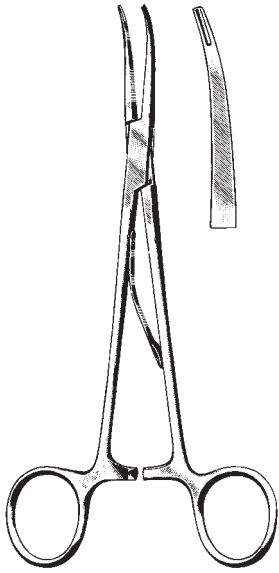

McKENZIE

41011-15 15 cm, 6"  
 41011-19 19 cm, 7 1/2"

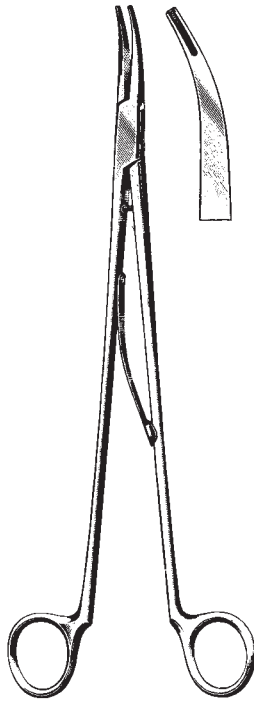

SMITHWICK

41015-23 23 cm, 9"  
 41015-26 26 cm, 10 1/4"

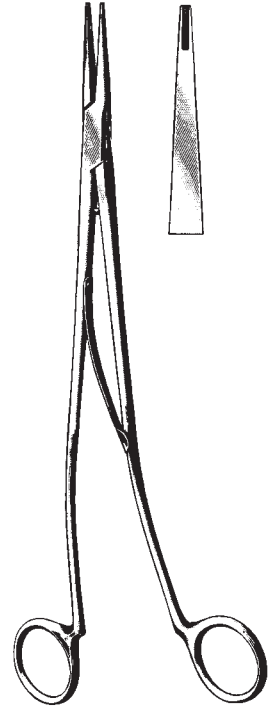

SWEET

41017-23 23 cm, 9"  
 41017-26 26 cm, 10 1/4"



OLIVECRONA-TOENNIS  
 41019-14

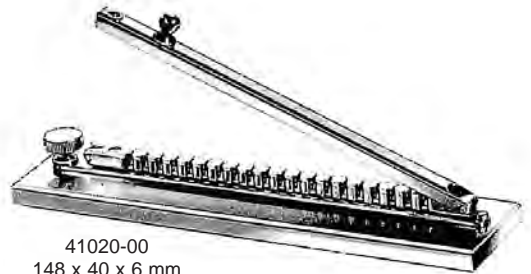

41020-00  
 148 x 40 x 6 mm

Schädelhalter, Kopfhautklammer, Anlegezange  
 Cervical Traction Tongs, Clips, Applying Forceps  
 Pinzas de tracción craneal, Clips, Pinza para aplicar clips  
 Pinze per trazione craniale, Pinza per applicare

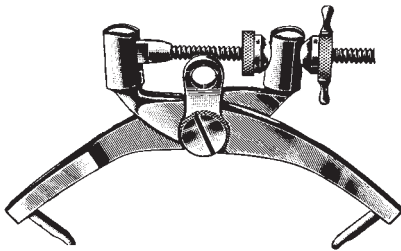

CRUTCHFIELD  
41025-01



CRUTCHFIELD  
41025-02



41026-35  
3,5 mm Ø



41026-50  
5 mm Ø

Stainless steel  
Acciaio inox



RANEY  
41027-00

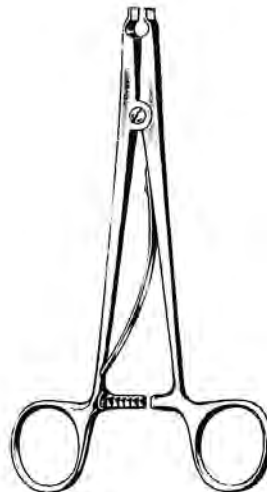

RANEY  
41028-00 16 cm, 6 1/4"



Nervhaken, Durahaken  
Nerve Hooks, Dura Hooks  
Ganchos para nervios y para dura-madre  
Unicini per nervi e per dura-madre



DANDY  
41051-20  
20 cm, 8"



DANDY  
41052-20  
20 cm, 8"



DANDY  
41053-20  
20 cm, 8"



CRILE  
41054-20  
20 cm, 8"



Fig. 1  
CUSHING  
41056-18  
18 cm, 7"

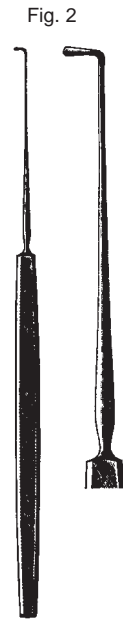

Fig. 2  
CUSHING  
41058-18  
18 cm, 7"

Nervhaken, Durahaken  
Nerve Hooks, Dura Hooks  
Ganchos para nervios y para dura-madre  
Unicini per nervi e per dura-madre



GRAHAM  
41061-16  
16,5 cm, 6 1/2"



SACHS  
41064-16  
18,5 cm, 7 1/4"



ADSON  
41068-20  
20 cm, 8"



ADSON  
41069-20  
20 cm, 8"

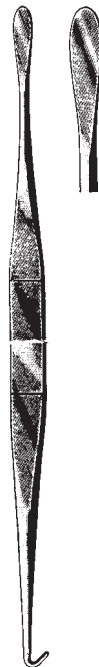

SMITHWICK  
41070-29  
29 cm, 11.4"

Nervwurzelhaken  
 Nerve Root Retractors  
 Separadores de raiz de nervios  
 Uncini per le radici dei nervi

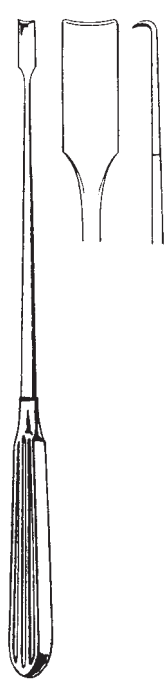

SCOVILLE  
 41074-23  
 23 cm, 9"

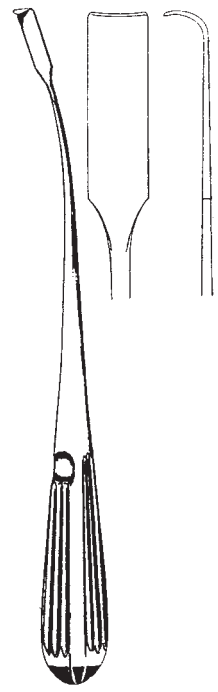

HOLSHER  
 41075-24  
 24 cm, 9 1/2"

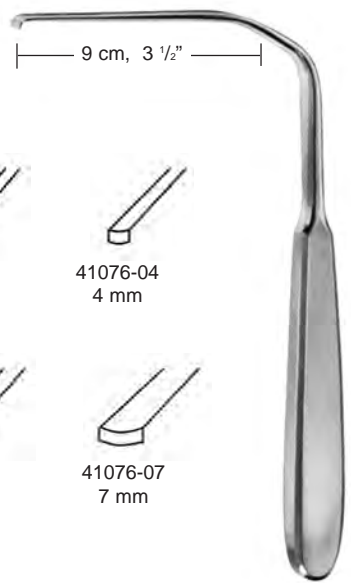

HESS  
 17,5 cm, 7"



41076-03  
 3 mm



41076-04  
 4 mm



41076-05  
 5 mm



41076-07  
 7 mm

Nervwurzelnhaken  
Nerve Root Retractors  
Separadores de raiz de nervios  
Uncini per le radici dei nervi

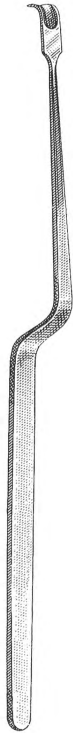

D'ERRICO  
41078-23  
23 cm, 9"



LOVE  
41079-21  
21 cm, 8 1/4"

Nervwurzelnhaken, Galea Haken  
 Nerve Root Retractors, Galea Hooks  
 Separadores de raíz de nervios, Gancho para galea  
 Uncini per le radici dei nervi, Uncini galea

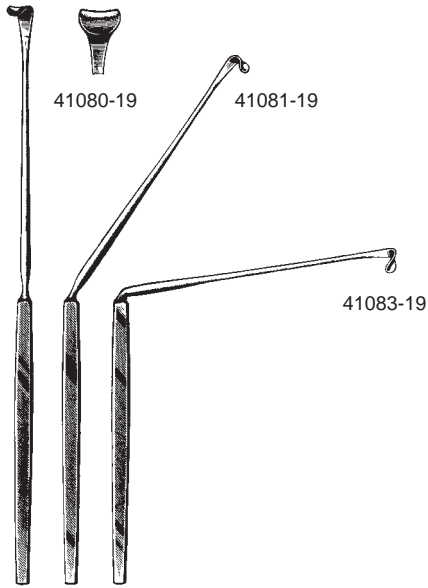

LOVE  
 41080-19 – 41083-19  
 19 cm, 7 1/2"

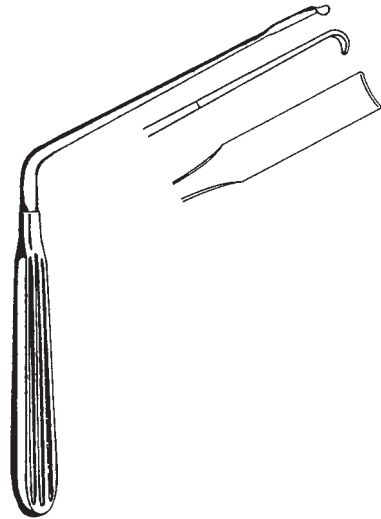

SCOVILLE  
 41085-20  
 20 cm, 8"



DeMARTEL  
 41090-33  
 33 cm, 13"



YASARGIL  
 41091-31  
 31 cm, 12 1/4"

Galeahaken  
 Galea Hooks  
 Gancho p/galea  
 Gancio p/galea

Ø 7 mm

4 mm



YASARGIL  
 41091-41  
 41 cm, 16"

Ø 9 mm

6 mm

Schädelstanze  
Cranial Punch  
Pinzas sacabocado craneal  
Pinza per craniotomia



CONE  
41097-22  
22,5 cm 9"

Dura Dissectoren, Schädelzange  
 Dura Dissectors, Skull Punches  
 Elevadores para la duramadre, Pinzas sacabocado craneal  
 Scollatori per duramadre, Pinza per craniotomia

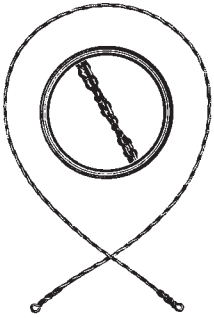

OLIVECRONA cm  
 41092-30 30, 11 3/4"  
 41092-40 40, 15 3/4"  
 41092-50 50, 19 3/4"  
 41092-60 60, 23 3/4"  
 41092-70 70, 27 1/2"

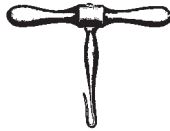

GIGLI  
 41094-00



DeVILBISS  
 41096-21  
 21 cm, 8 1/4"

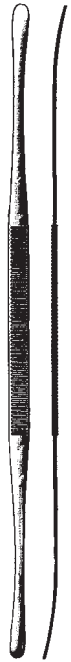

TOENNIS  
 41141-25  
 25 cm, 10"



SACHS  
 41143-21  
 21 cm, 8 1/4"

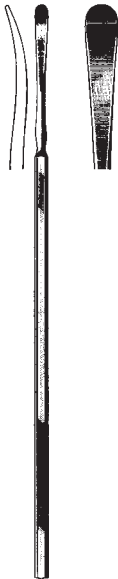

SACHS  
 41145-21  
 21 cm, 8 1/4"



OLIVECRONA  
 41146-18 18 cm, 7"  
 41146-24 24 cm, 9 1/2"

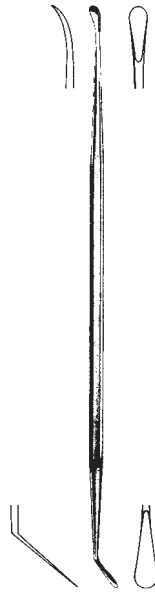

MILLIGAN  
 41147-21  
 21 cm, 8 1/4"



41149-22  
 22 cm, 8 3/4"

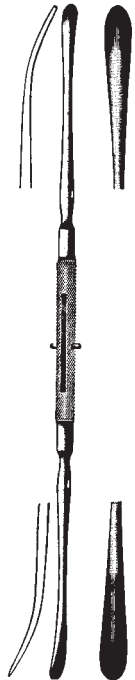

DAVIS  
 41151-24  
 24 cm, 9 1/2"

Dura Dissektoren  
 Dura Dissectors  
 Elevadores  
 Scollatori

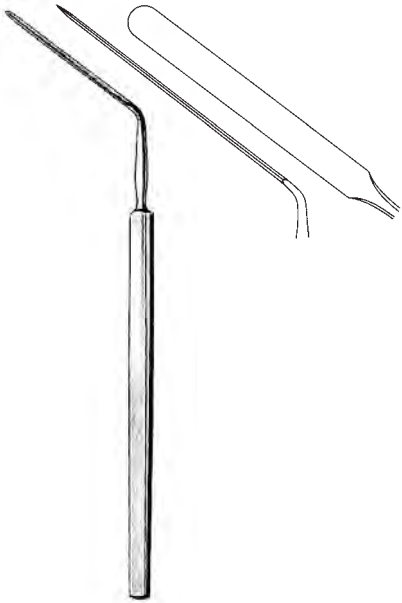

HORSLEY  
 41155-20  
 20 cm, 8"



WOODSON  
 41156-18  
 18 cm, 7"



FRAZIER  
 41158-01  
 15 cm, 6"



HOEN  
 41158-02  
 15 cm, 6"

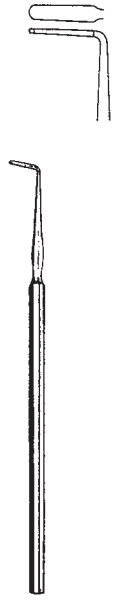

HOEN  
 41158-03  
 15 cm, 6"



PENFIELD  
 41161-01  
 17,5 cm, 6.9"



PENFIELD  
 41161-02  
 19,5 cm, 7 3/4"



PENFIELD  
 41161-03  
 19,5 cm, 7 3/4"



PENFIELD  
 41161-04  
 21,5 cm, 8 1/2"



PENFIELD  
 41161-05  
 29 cm 11.4"



Hypophyse Pinzetten, Küretten  
 Hypophyseal Forceps, Curette  
 Pinzas para hipófisis, Curetas  
 Pinze per ipofisi, Curette



ADSON  
 41210-23  
 23 cm, 9"



ADSON  
 41211-23  
 23 cm, 9"



ADSON  
 41213-23  
 23 cm, 9"



41221-00  
 19 cm, 7 1/2"



41222-00  
 19 cm, 7 1/2"



41223-00  
 19 cm, 7 1/2"



41224-00  
 19 cm, 7 1/2"

Messer, Haken, Sonden  
 Knives, Hooks, Probes  
 Bisturies, Ganchos, Sondas  
 Bisturi, Uncino, Sonde

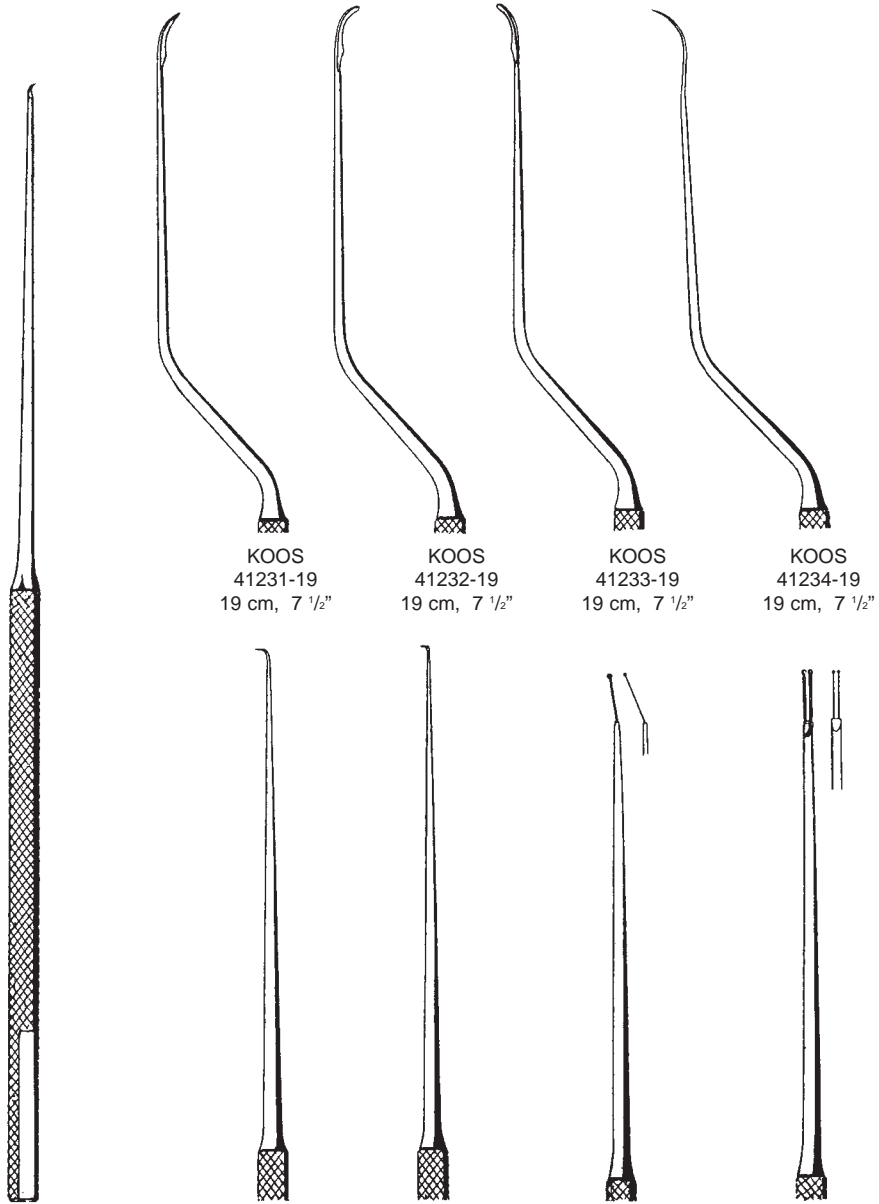

KOOS  
 41231-19  
 19 cm, 7 1/2"

KOOS  
 41232-19  
 19 cm, 7 1/2"

KOOS  
 41233-19  
 19 cm, 7 1/2"

KOOS  
 41234-19  
 19 cm, 7 1/2"

JACOBSON  
 41230-19  
 19 cm, 7 1/2"

41236-19  
 19 cm, 7 1/2"

FISCH  
 41237-19  
 19 cm, 7 1/2"

JACOBSON  
 41238-19  
 19 cm, 7 1/2"

JACOBSON  
 41239-19cm  
 19 cm, 7 1/2"

Durahaken  
 Dura Hook  
 Ganchito para dura-madre  
 Uncino dura madre

Feines Häkchen  
 Delicate Hook  
 Ganchito muy fino  
 Uncino molto fino

Knopfsonde  
 Buttoned Probe  
 Sonda abotonada  
 Sonda bottonuta

Doppelsonde  
 Twin Probe  
 Sonda doble  
 Sonda doppia

Nervhäkchen, Hirnspatel, Saugrohre  
 Nerve Hooks, Brain Spatulas, Suction Tubes  
 Ganchos para nervios, Espatulas cerebrales, Tubos de aspiración  
 Uncini per nervi, Spatole cerebrali, Tubi aspirazioni



KRAYENBÜHL  
 41242-19  
 19 cm, 7 1/2"



KRAYENBÜHL  
 41243-19  
 19 cm, 7 1/2"



KRAYENBÜHL  
 41244-19  
 19 cm, 7 1/2"



KRAYENBÜHL  
 41245-19  
 19 cm, 7 1/2"

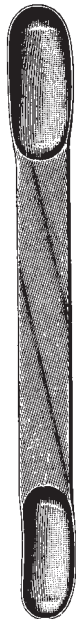

CUSHING  
 41250-11 8x10 mm  
 41250-15 13x15 mm  
 41250-18 16x18 mm

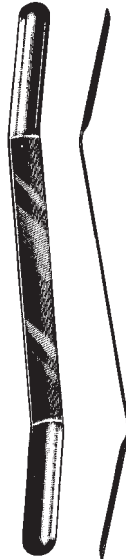

OLIVECRONA mm  
 41253-07 7/ 9  
 41253-11 11/13  
 41253-15 15/18  
 41253-18 18/22

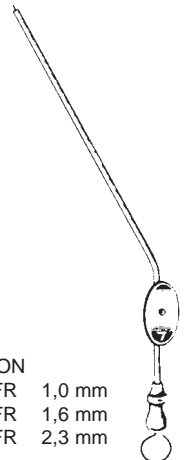

BARON  
 41299-03 3FR 1,0 mm  
 41299-05 5FR 1,6 mm  
 41299-07 7FR 2,3 mm

Hirnspatel, Saugrohre, Punktionskanüle  
 Brain Spatulas, Suction Tubes, Puncture Cannulas  
 Espatulas cerebrales, Tubos de aspiración, Tubo de punción  
 Spatole cerebrali, Tubi aspirazioni, cannula per punzione

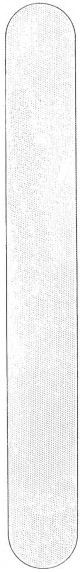

biegsam  
 malleable  
 maleable  
 malleabile

DAVIS	18 cm, 7"
41254-06	6 mm, 1/4"
41254-10	9 mm, 3/8"
41254-13	13 mm, 1/2"
41254-16	16 mm, 5/8"
41254-19	19 mm, 3/4"
41254-25	25 mm, 1"
41254-32	32 mm, 1 1/4"
41254-38	38 mm, 1 1/2"



ADSON  
 41290-21  
 21 cm, 8 1/4"  
 ø 4 mm



FERGUSON  
 41294-40  
 18 cm, 7"  
 ø 4 mm, 90°

Charr.	↔	
F.G.	30°	75°
6	41295-06	41297-06
7	41295-07	41297-07
8	41295-08	41297-08
9	41295-09	41297-09
10	41295-10	41297-10
11	41295-11	41297-11
12	41295-12	41297-12
15	41295-15	

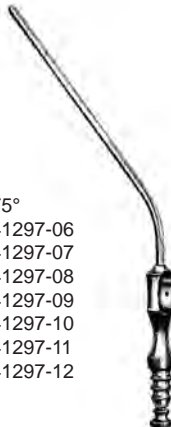

FRAZIER / FERGUSON  
 41295-06 – 41297-12  
 19 cm, 7 1/2"



FRAZIER / FERGUSON  
 41298-12  
 12 cm, 4 3/4" / 3 mm

Saugrohre  
Suction Tubes  
Tubos de aspiración  
Tubi aspirazioni

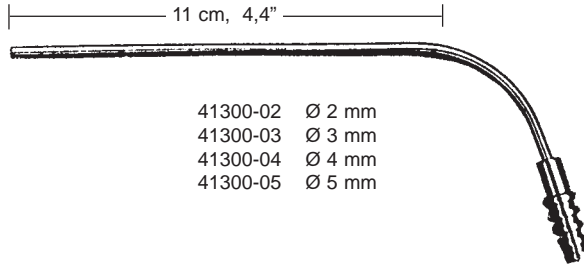

- 41300-02 Ø 2 mm
- 41300-03 Ø 3 mm
- 41300-04 Ø 4 mm
- 41300-05 Ø 5 mm

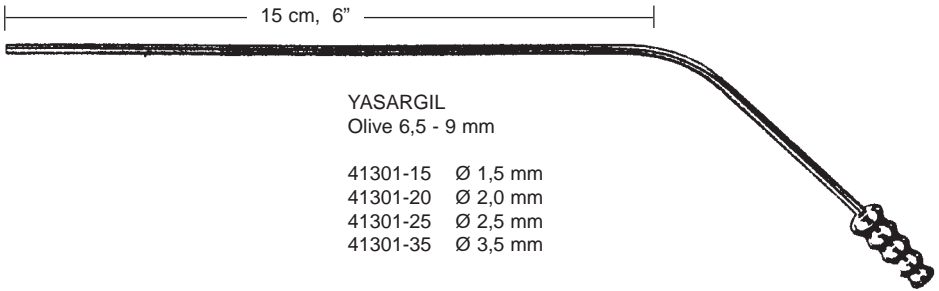

YASARGIL  
Olive 6,5 - 9 mm

- 41301-15 Ø 1,5 mm
- 41301-20 Ø 2,0 mm
- 41301-25 Ø 2,5 mm
- 41301-35 Ø 3,5 mm

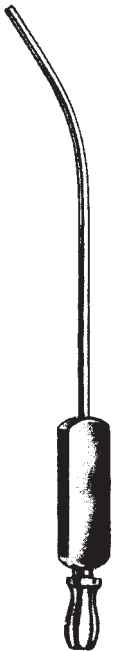

ZÖLLNER  
41302-01



ZÖLLNER  
41302-02



- 0,5 mm Ø 41306-05
- 0,7 mm Ø 41306-07
- 0,9 mm Ø 41306-09
- 1,2 mm Ø 41306-12

Kanüle für Sauggriff für Zöllner und Wullstein  
Tip for Suction Handle for Zöllner and Wullstein  
Cánula para mango t Zöllner y Wullstein  
Cannula per manico di aspirazione t Zöllner e Wullstein

Saugrohre  
Suction Tubes  
Tubos de aspiración  
Tubi aspirazioni

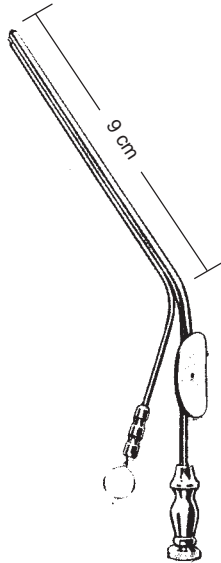

HOUSE

9 cm, 3 1/2"

41303-09	Ø 0,9 x 0,7 mm
41303-12	Ø 1,2 x 0,9 mm
41303-15	Ø 1,5 x 1,2 mm
41303-18	Ø 1,8 x 1,8 mm
41303-25	Ø 2,5 x 2,0 mm
41303-30	Ø 3,0 x 2,0 mm
41303-45	Ø 4,5 x 2,0 mm

Saugrohre, Saugkanülen  
 Suction Tubes, Suction Cannulae  
 Tubos de aspiración, Cánulas para aspiración  
 Tubi aspirazioni, Cannule per aspirazione



Sauggriff  
 Suction Handle  
 Mango de aspiración  
 Manico per aspirazione

WULLSTEIN  
 41307-00

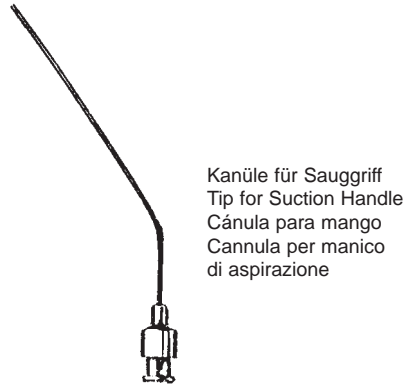

Kanüle für Sauggriff  
 Tip for Suction Handle  
 Cánula para mango  
 Cannula per manico  
 di aspirazione

ROSEN

0,5 mm Ø	41305-05	1,4 mm Ø	41305-14
0,6 mm Ø	41305-06	1,5 mm Ø	41305-15
0,7 mm Ø	41305-07	1,8 mm Ø	41305-18
0,8 mm Ø	41305-08	2,0 mm Ø	41305-20
0,9 mm Ø	41305-09	2,5 mm Ø	41305-25
1,0 mm Ø	41305-10	3,0 mm Ø	41305-30
1,2 mm Ø	41305-12		



Charr. 6 41304-06  
 Charr. 8 41304-08  
 Charr. 10 41304-10

PLESTER  
 30°



biegsam  
 malleable  
 malleable  
 malleabile

SCHMID  
 15 cm, 6°



Ø 3 mm  
 41307-03



Ø 4 mm  
 41307-04

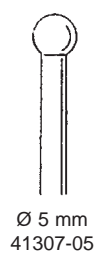

Ø 5 mm  
 41307-05



Ø 6 mm  
 41307-06

Wirbelkörperspreizer  
 Lamina Spreaders  
 Separadores para cuerpos vertebrales  
 Divaricatori per corpi vertebrali



CLOWARD  
 41401-16



INGE  
 41405-17 – 41405-27

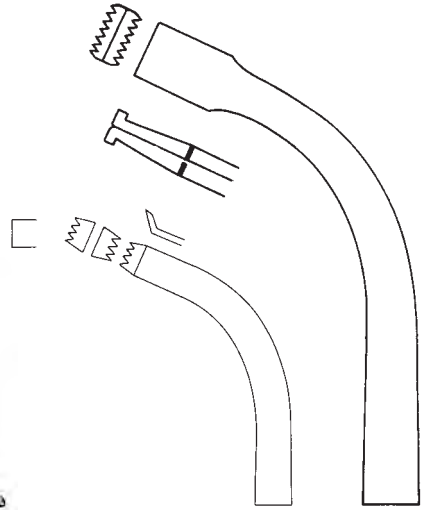

41405-17  
 17 cm  
 6 3/4"

41405-27  
 27 cm  
 10 1/2"



19 mm

CLOWARD  
 41406-01  
 12,5 cm, 5"

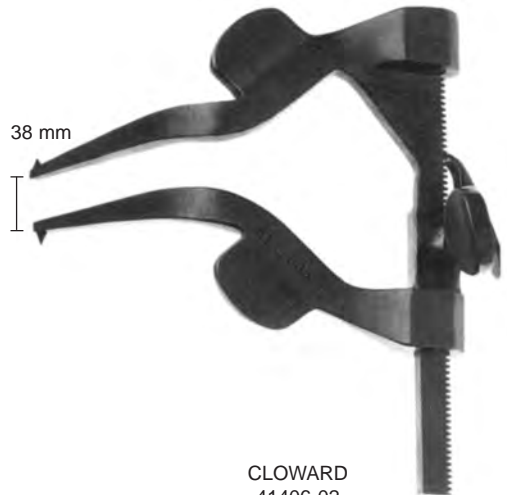

38 mm



CLOWARD  
 41406-02  
 7,6 cm, 3"



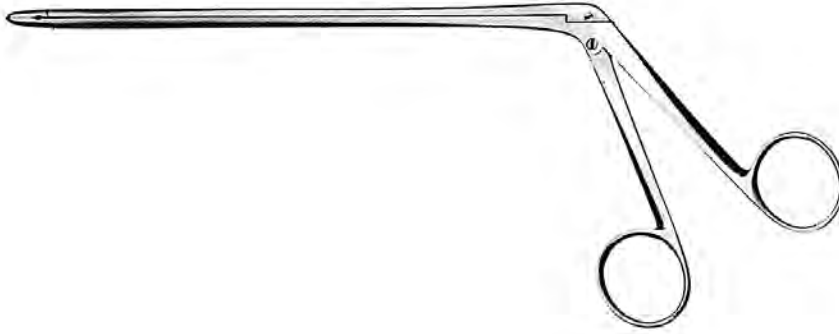

Laminektomie Zangen  
 Laminectomy Rongeurs  
 Pinzas cortantes para laminectomia  
 Pinze taglienti per laminectomia



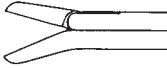

CUSHING  
 2 mm

			
	2x10 mm L	2x10 mm/45° L	2x10 mm/45° L
	41420-01 12,5 cm	41420-02 12,5 cm	41420-03 12,5 cm
	41421-01 15,0 cm	41421-02 15,0 cm	41421-03 15,0 cm
	41422-01 18,0 cm	41422-02 18,0 cm	41422-03 18,0 cm

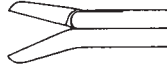
LOVE-GRUENWALD  
 3 mm

			
	3x10 mm L	3x10 mm/45° L	3x10 mm/45° L
	41430-01 12,5 cm	41430-02 12,5 cm	41430-03 12,5 cm
	41431-01 15,0 cm	41431-02 15,0 cm	41431-03 15,0 cm
	41432-01 18,0 cm	41432-02 18,0 cm	41432-03 18,0 cm

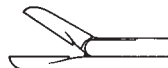
SPURLING  
 4 mm

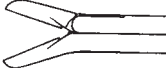
			
	4x10 mm L	4x10 mm/45° L	4x10 mm/45° L
	41440-01 12,5 cm	41440-02 12,5 cm	41440-03 12,5 cm
	41441-01 15,0 cm	41441-02 15,0 cm	41441-03 15,0 cm
	41442-01 18,0 cm	41442-02 18,0 cm	41442-03 18,0 cm

Laminektomie Zangen  
 Laminectomy Rongeurs  
 Pinzas cortantes para laminectomia  
 Pinze taglienti per laminectomia

185 mm

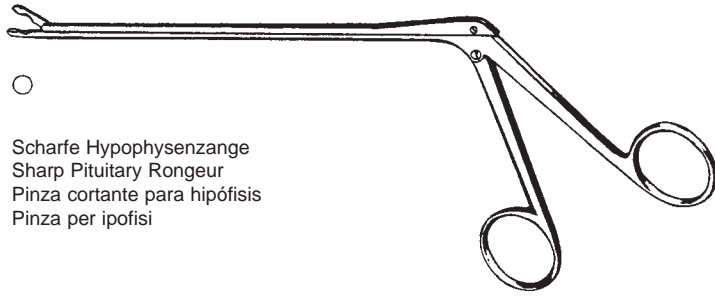

Scharfe Hypophysenzange  
 Sharp Pituitary Rongeur  
 Pinza cortante para hipofisis  
 Pinza per ipofisi

41443-26  
 25,5 cm, 10"

180 mm

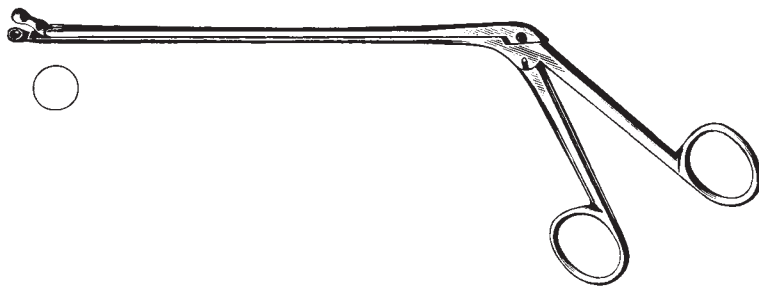

OLDBERG  
 41445-25  
 25 cm (9.8"), Ø 7 mm

200 mm

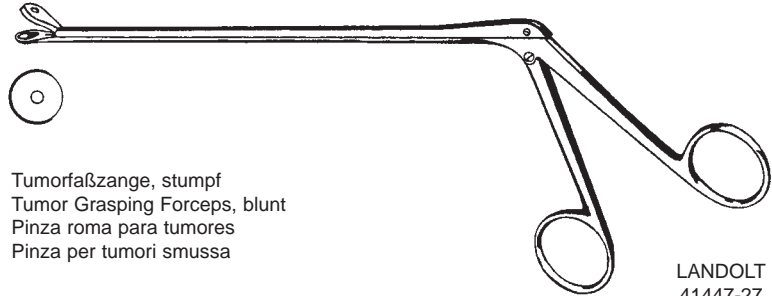

Tumorfaßzange, stumpf  
 Tumor Grasping Forceps, blunt  
 Pinza roma para tumores  
 Pinza per tumori smussa

LANDOLT  
 41447-27  
 27 cm (10 1/2"), Ø 9 mm

Laminektomie Zangen  
 Laminectomy Rongeurs  
 Pinzas cortantes para laminectomia  
 Pinze taglianti per laminectomia

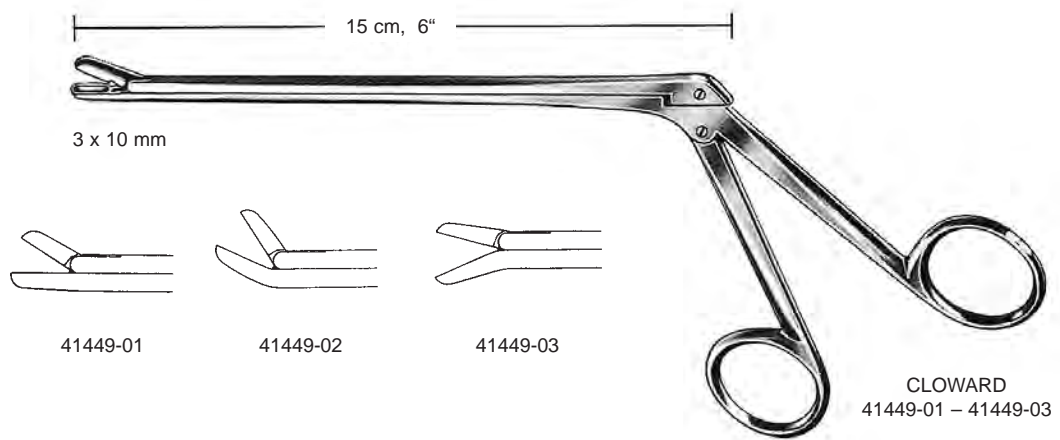
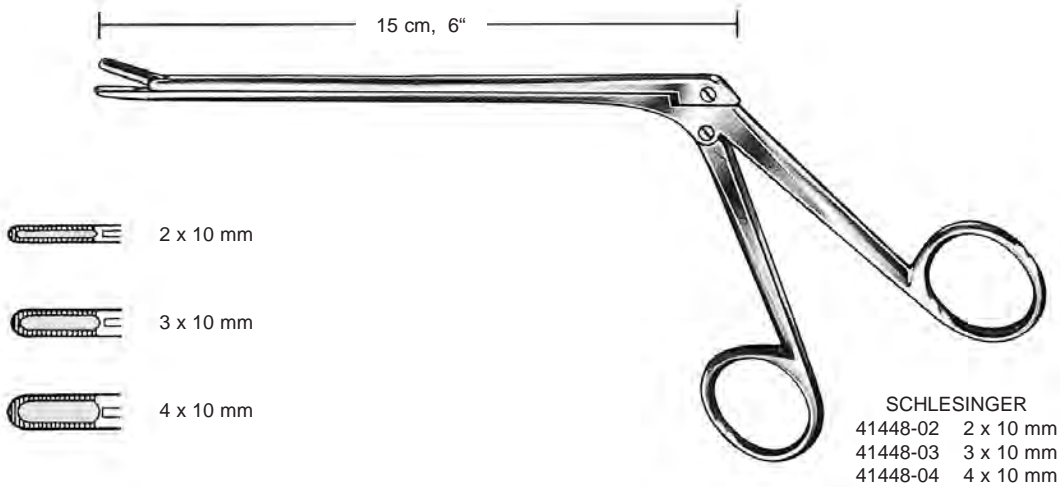

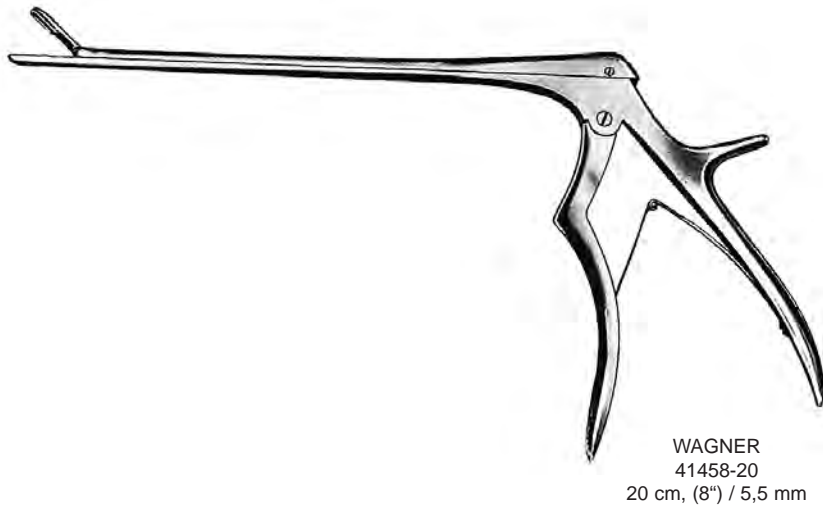
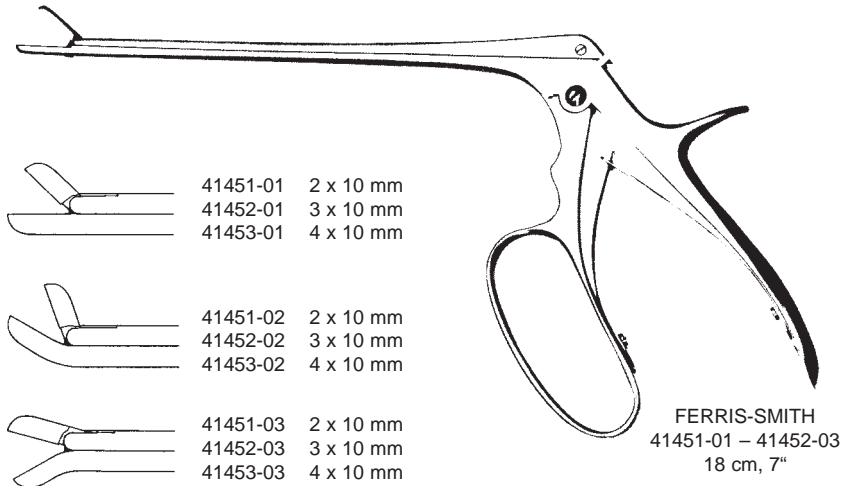

Laminektomie Zangen  
 Laminectomy Rongeurs  
 Pinzas cortantes para laminectomia  
 Pinze taglienti per laminectomia

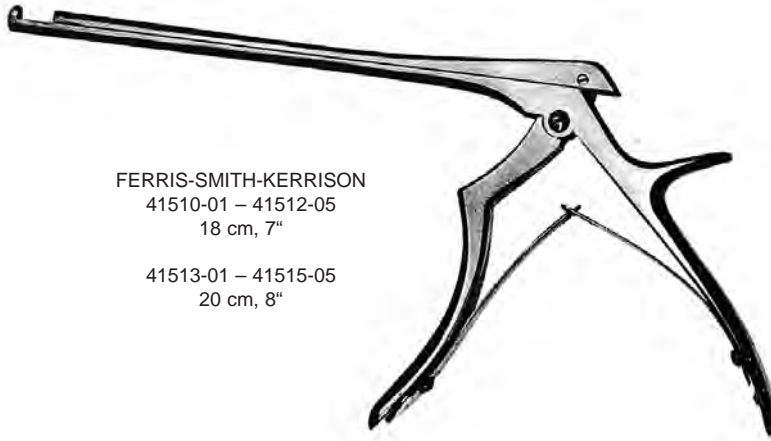

Bandscheibenstanzen  
 Intervertebral Disc Rongeurs  
 Pinzas sacabocado para discos intervertebrales  
 Pinze taglienti per dischi intervertebrali

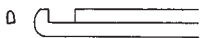
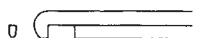
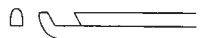
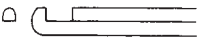

FERRIS-SMITH-KERRISON  
 41510-01 – 41512-05  
 18 cm, 7"  
 41513-01 – 41515-05  
 20 cm, 8"

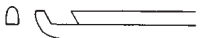
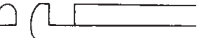
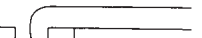
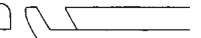
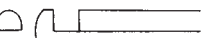
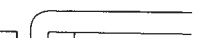
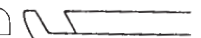
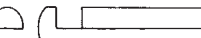
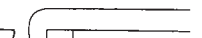
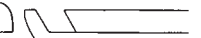
	90°	90°	40°
18 cm	 41510-01 1 mm	 41511-01 1 mm	 41512-01 1 mm
20 cm	41513-01 1 mm	41514-01 1 mm	41515-01 1 mm
18 cm	 41510-02 2 mm	 41511-02 2 mm	 41512-02 2 mm
20 cm	41513-02 2 mm	41514-02 2 mm	41515-02 2 mm
18 cm	 41510-03 3 mm	 41511-03 3 mm	 41512-03 3 mm
20 cm	41513-03 3 mm	41514-03 3 mm	41515-03 3 mm
18 cm	 41510-04 4 mm	 41511-04 4 mm	 41512-04 4 mm
20 cm	41513-04 4 mm	41514-04 4 mm	41515-04 4 mm
18 cm	 41510-05 5 mm	 41511-05 5 mm	 41512-05 5 mm
20 cm	41513-05 5 mm	41514-05 5 mm	41515-05 5 mm

Bandscheibenstanzen  
 Intervertebral Disc Rongeurs  
 Pinzas sacabocado para discos intervertebrales  
 Pinze taglianti per dischi intervertebrali

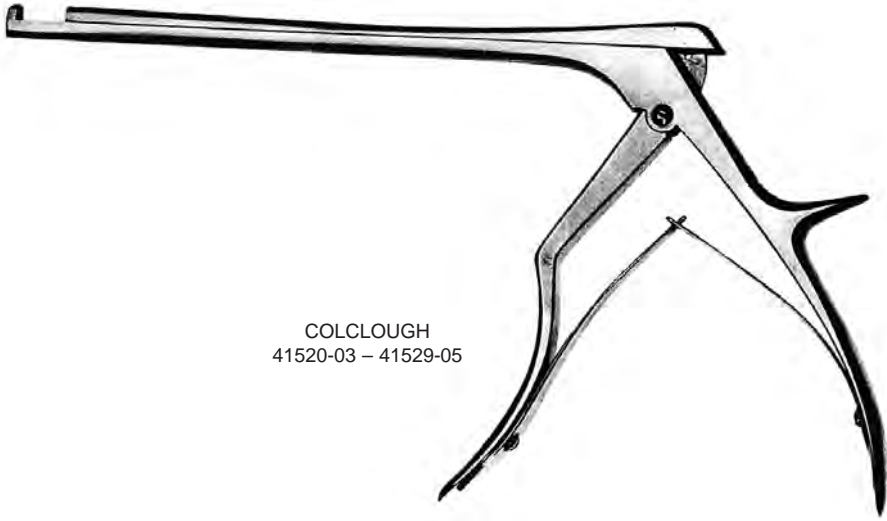

COLCLOUGH  
 41520-03 – 41529-05

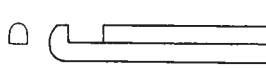

3 mm  
 41520-03 15 cm, 6"  
 41522-03 20 cm, 8"



5 mm  
 41520-05 15 cm, 6"  
 41522-05 20 cm, 8"

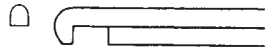

3 mm  
 41524-03 15 cm, 6"  
 41526-03 20 cm, 8"



5 mm  
 41524-05 15 cm, 6"  
 41526-05 20 cm, 8"



3 mm  
 41527-03 15 cm, 6"  
 41529-03 20 cm, 8"



5 mm  
 41527-05 15 cm, 6"  
 41529-05 20 cm, 8"

Zerlegbare Stanzen  
Detachable punches  
Pinzas cortantes desmontables  
Pinze taglienti e smontabili

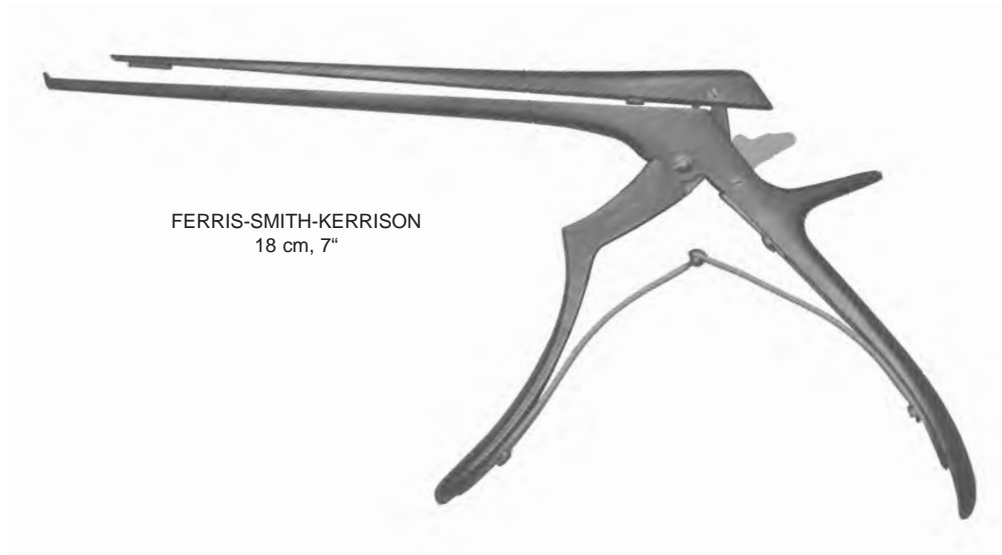

90°



41540-02 2 mm

41540-03 3 mm

41540-04 4 mm

41540-05 5 mm

130°



41542-02 2 mm

41542-03 3 mm

41542-04 4 mm

41542-05 5 mm

aus hochwertigem Implantat-Stahl antimagnetisch  
in high quality Implant steel antimagnetic  
de acero inoxidable para implantes de alta calidad, antimagnético  
Prodotto in acciaio di alta qualità, antimagnetico

## Features of the Clip

### SERIAL-NUMBER

Each clip is coded with an individual serial number – marked by laser technology-  
The serial number guarantees a detailed follow-up of

- the whole production process
- the closure force
- from raw material to the final product

These informations are registered in our company for the period of 10 years.

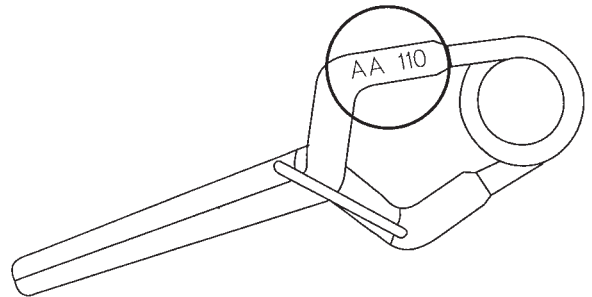

### PACKING – LABELING

Each clip is individually packaged in a transparent box made of resistant plastic.  
Special wishes of customers regarding the packaging will be considered by us. This will be marked on an internal instruction.

The transparent box is marked with a label in order to assure a quick and sure identification of the clip.

On the label you can find the following data:

- catalogue number
- Product description
- Illustration
- Closing force in g
- Tolerance range of closing force
- Blade length
- Maximum opening
- Blade geometry
- Serial number
- Jaw profile
- Material description
- Lot number
- the notes "NOT STERILE"
- WARNING

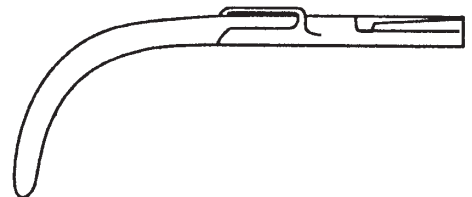
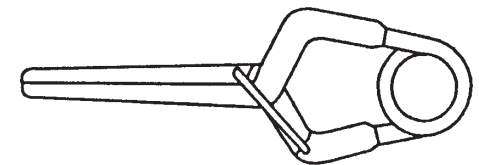



YASARGIL – Aneurysmen – Gefäß – Clips  
YASARGIL – Aneurysm – Vessel – Clips  
YASARGIL – Clips para aneurisma  
YASARGIL – Clips per aneurisma

aus hochwertigem Implantat-Stahl antimagnetisch  
in high quality Implant steel antimagnetic  
de acero inoxidable para implantes de alta calidad, antimagnético  
Prodotto in acciaio di alta qualità, antimagnetico

## Features of the Clip

### JAW-PROFILE

The rounded, pyramid-like structure is stamped into the jaw through a special step in production and prevents sharp edged which could perforate an aneurysm

No edges or burrs through additional rounding of structures that border the clip outer side because of this, real atraumatic application of the clip

Increased surface area due to the pyramid-like design of the jaws inner surface the cross-like structure of the inner jaws pyramid surface doubles the tissue-holding area.

The applied pressure distributes itself evenly over the length of the jaw.

The convex closure of the clip assures an atraumatic and secure closure of the aneurysm.

Sliding of the clip is prevented.

### SPRING-DESIGN

The spring size, which is different in the Standard and Mini clips, is the same within the same type of the Clip.

Through this, the highest degree of a secure fit is ensured by the clip applicator (clip/clip applicator fit)

### LINK-DESIGN

Laser welded

The link ensures the precise guidance of the jaws and a "soft" opening of the clip during the whole spreading process.

The contact surface of the jaws are guided symmetrically in an exact way "over the whole length" this fact guarantees an additional stability of the clip.

No over-stress of the material because the design of the link limits the maximum opening width.

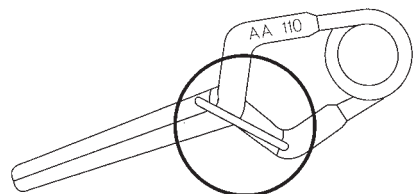
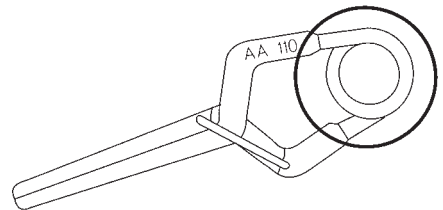
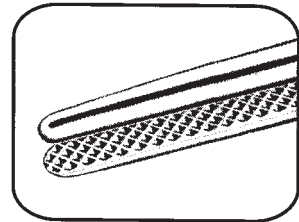
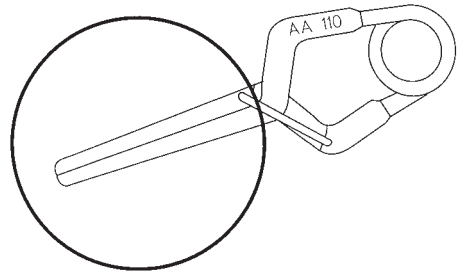

YASARGIL – Aneurysmen – Gefäß – Clips  
YASARGIL – Aneurysm – Vessel – Clips  
YASARGIL – Clips para aneurisma  
YASARGIL – Clips per aneurisma

aus hochwertigem Implantat-Stahl antimagnetisch  
in high quality Implant steel antimagnetic  
de acero inoxidable para implantes de alta calidad, antimagnético  
Prodotto in acciaio di alta qualità, antimagnetico

## Features of the Clip

### CLOSING-FORCE

The closing force is measured at one third of the jaw length and an opening of 0,5 mm.

The final quality control of the clip is effected by a microprocessor-controlled measuring equipment.

The closing force is indicated exactly within a certain tolerance.

By the help of a special software program we assure that before the clip passes the final quality control its closure force is fixed. As a consequence we exclude any kind of manipulation.

All relevant technical data are stored during the control procedure and printed on the label.

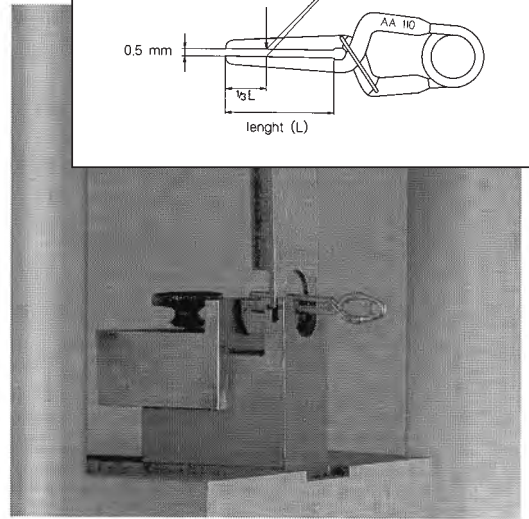
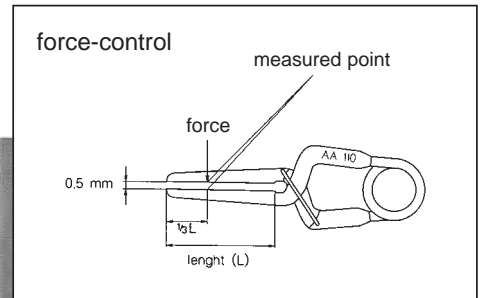

## Material and Quality Assurance

According to DIN 17445, implant steel is used in the production of our Aneurysm Clip

- High stability characteristics
- Excellent tissue compatibility
- Secure closure of blood vessels
- Antimagnetic
- Ideally suited as implantation material
- Security against over straining

YASARGIL – Aneurysmen – Gefäß – Clips  
YASARGIL – Aneurysm – Vessel – Clips  
YASARGIL – Clips para aneurisma  
YASARGIL – Clips per aneurisma

aus hochwertigem Implantat-Stahl antimagnetisch  
in high quality Implant steel antimagnetic  
de acero inoxidable para implantes de alta calidad, antimagnético  
Prodotto in acciaio di alta qualità, antimagnetico

Erklärung zum Katalog-System  
Instructions for the catalogue-system  
Explicaciones para el sistema del catálogo  
Esempio del sistema del catalogo

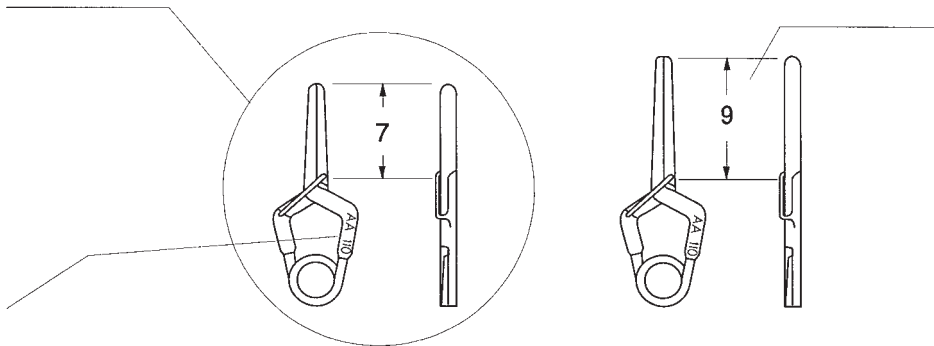

YASARGIL – Aneurysmen – Gefäß – Clips  
 YASARGIL – Aneurysm – Vessel – Clips  
 YASARGIL – Clips para aneurisma  
 YASARGIL – Clips per aneurisma

aus hochwertigem Implantat-Stahl antimagnetisch  
 in high quality Implant steel antimagnetic  
 de acero inoxidable para implantes de alta calidad, antimagnético  
 Prodotto in acciaio di alta qualità, antimagnetico

YASARGIL-STANDARD für permanenten Verschluss  
 YASARGIL-STANDARD for permanent closure  
 YASARGIL-STANDARD para cierre permanente  
 YASARGIL-STANDARD con chiusura permanente

## Standard

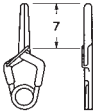
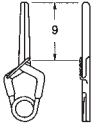
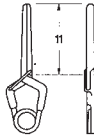
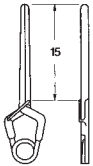
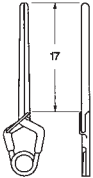
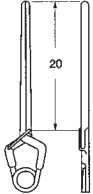
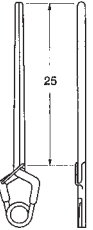
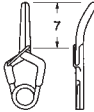
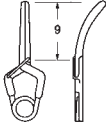
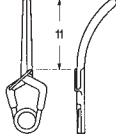
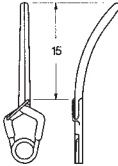
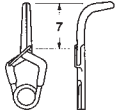
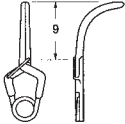
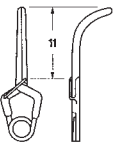
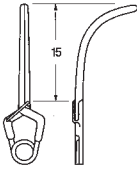
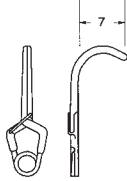
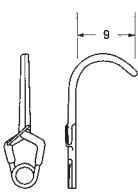
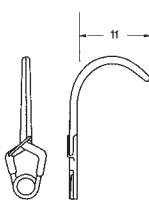
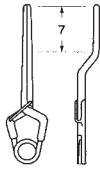
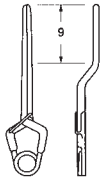
							
Cat. Nr.	41600-62	41600-70	41600-78	41600-92	41601-10	41601-11	
	<b>41600-62 T</b>	<b>41600-70 T</b>	<b>41600-78 T</b>	<b>41600-92 T</b>	<b>41601-10 T</b>	<b>41601-11 T</b>	
max. opening	6,2 mm	7,0 mm	7,8 mm	9,2 mm	10,6 mm	11,4 mm	
Force	150 gms	180 gms	180 gms	200 gms	200 gms	200 gms	
							
	41601-13	41602-60	41602-68	41602-75	41602-87	41603-55	41603-61
	<b>41601-13 T</b>	<b>41602-60 T</b>	<b>41602-68 T</b>	<b>41602-75 T</b>	<b>41602-87 T</b>	<b>41603-55 T</b>	<b>41603-61 T</b>
	13,3 mm	6,0 mm	6,8 mm	7,5 mm	8,7 mm	5,5 mm	6,1 mm
	200 gms	150 gms	180 gms	180 gms	200 gms	150 gms	180 gms
							
	41603-65	41603-74	41604-54	41604-58	41604-62	41604-79	41604-87
	<b>41603-65 T</b>	<b>41603-74 T</b>	<b>41604-54 T</b>	<b>41604-58 T</b>	<b>41604-62 T</b>	<b>41604-79 T</b>	<b>41604-87 T</b>
	6,5 mm	7,4 mm	5,4 mm	5,8 mm	6,2 mm	7,9 mm	8,7 mm
	180 gms	200 gms	180 gms	180 gms	180 gms	200 gms	200 gms

YASARGIL – Aneurysmen – Gefäß – Clips

YASARGIL – Aneurysm – Vessel – Clips

YASARGIL – Clips para aneurisma

YASARGIL – Clips per aneurisma

aus hochwertigem Implantat-Stahl antimagnetisch  
 in high quality Implant steel antimagnetic  
 de acero inoxidable para implantes de alta calidad, antimagnético  
 Prodotto in acciaio di alta qualità, antimagnetico

YASARGIL-STANDARD für permanenten Verschluss

YASARGIL-STANDARD for permanent closure

YASARGIL-STANDARD para cierre permanente

YASARGIL-STANDARD con chiusura permanente

## Standard

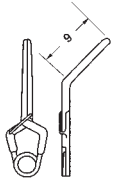
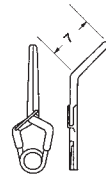
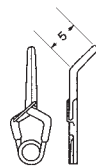
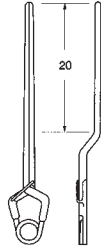
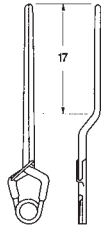
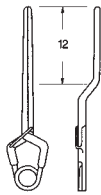

Cat. Nr.  
 max. opening  
 Force

41605-10  
**41605-10 T**  
 10,2 mm  
 200 gms

41605-12  
**41605-12 T**  
 11,9 mm  
 180 gms

41605-13  
**41605-13 T**  
 13,0 mm  
 180 gms

41606-62  
**41606-62-T**  
 6,2 mm  
 200 gms

41606-65  
**41606-65 T**  
 6,5 mm  
 200 gms

41606-78  
**41606-78 T**  
 7,8 mm  
 200 gms

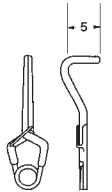
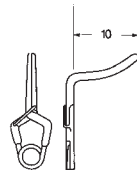
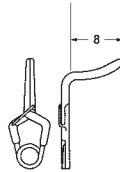
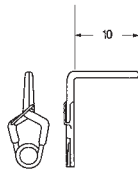
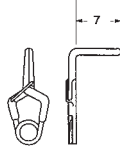
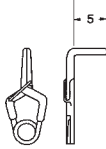
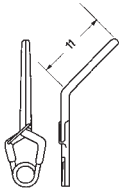

41606-84  
**41606-84 T**  
 8,4 mm  
 200 gms

41607-56  
**41607-56 T**  
 5,6 mm  
 200 gms

41607-57  
**41607-57 T**  
 5,6 mm  
 200 gms

41607-58  
**41607-58 T**  
 5,6 mm  
 200 gms

41607-59  
**41607-59 T**  
 5,4 mm  
 200 gms

41607-60  
**41607-60 T**  
 5,6 mm  
 200 gms

41607-72  
**41607-72 T**  
 7,2 mm  
 200 gms

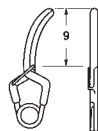
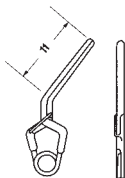
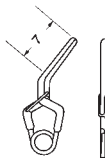
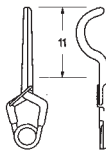
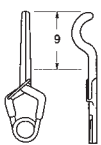

41607-73  
**41607-73 T**  
 7,2 mm  
 200 gms

41607-82  
**41607-82 T**  
 8,2 mm  
 200 gms

41608-57  
**41608-57 T**  
 5,7 mm  
 200 gms

41608-80  
**41608-80 T**  
 8,0 mm  
 200 gms

41609-70  
**41609-70 T**  
 7,0 mm  
 200 gms

YASARGIL – Aneurysmen – Gefäß – Clips  
 YASARGIL – Aneurysm – Vessel – Clips  
 YASARGIL – Clips para aneurisma  
 YASARGIL – Clips per aneurisma

aus hochwertigem Implantat-Stahl antimagnetisch  
 in high quality Implant steel antimagnetic  
 de acero inoxidable para implantes de alta calidad, antimagnético  
 Prodotto in acciaio di alta qualità, antimagnetico

YASARGIL-STANDARD für temporären Verschluss  
 YASARGIL-STANDARD for temporary closure  
 YASARGIL-STANDARD para cierre temporal  
 YASARGIL-STANDARD con chiusura temporanea

## Standard

Cat. Nr.	41610-61	41610-68	41610-70	41611-74	41611-87	41611-92
	<b>41610-61 T</b>	<b>41610-68 T</b>	<b>41610-70 T</b>	<b>41611-74 T</b>	<b>41611-87 T</b>	<b>41611-92 T</b>
max. opening	6,1 mm	6,8 mm	7,0 mm	7,4 mm	8,7 mm	9,2 mm
Force	70 gms	70 gms	70 gms	70 gms	70 gms	70 gms
	41612-07	41612-09	41612-11	41612-12	41612-62	
	<b>41612-07 T</b>	<b>41612-09 T</b>	<b>41612-11 T</b>	<b>41612-12 T</b>	<b>41612-62 T</b>	
	7,5 mm	9,9 mm	11,0 mm	11,4 mm	6,2 mm	
	90 gms	90 gms	90 gms	90 gms	70 gms	

YASARGIL – Aneurysmen – Gefäß – Clips

YASARGIL – Aneurysm – Vessel – Clips

YASARGIL – Clips para aneurisma

YASARGIL – Clips per aneurisma

aus hochwertigem Implantat-Stahl antimagnetisch  
in high quality Implant steel antimagnetic  
de acero inoxidable para implantes de alta calidad, antimagnético  
Prodotto in acciaio di alta qualità, antimagnetico

YASARGIL-STANDARD für permanenten Verschluss

YASARGIL-STANDARD for permanent closure

YASARGIL-STANDARD para cierre permanente

YASARGIL-STANDARD con chiusura permanente

## Standard

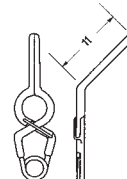
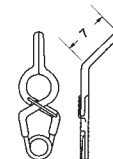
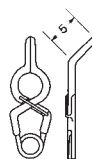
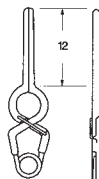
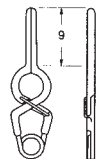
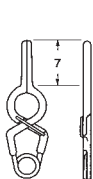

Cat. Nr.

41613-74

41613-84

41613-96

41614-58

41614-65

41614-72

41613-74 T

41613-84 T

41613-96 T

41614-58 T

41614-65 T

41614-72 T

max. opening

7,4 mm

8,4 mm

9,6 mm

5,8 mm

6,5 mm

7,2 mm

Force

150 gms

150 gms

180 gms

150 gms

150 gms

180 gms

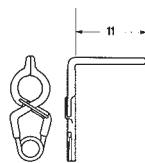
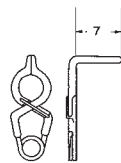
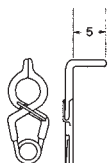

41615-49

41615-50

41615-51

41615-49 T

41615-50 T

41615-51 T

4,9 mm

4,9 mm

4,9 mm

150 gms

150 gms

180 gms

YASARGIL – Aneurysmen – Gefäß – Clips  
 YASARGIL – Aneurysm – Vessel – Clips  
 YASARGIL – Clips para aneurisma  
 YASARGIL – Clips per aneurisma

aus hochwertigem Implantat-Stahl antimagnetisch  
 in high quality Implant steel antimagnetic  
 de acero inoxidable para implantes de alta calidad, antimagnético  
 Prodotto in acciaio di alta qualità, antimagnetico

YASARGIL-STANDARD für permanenten Verschluss  
 YASARGIL-STANDARD for permanent closure  
 YASARGIL-STANDARD para cierre permanente  
 YASARGIL-STANDARD con chiusura permanente

## Standard

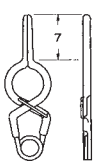
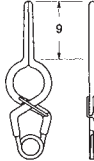
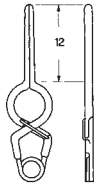
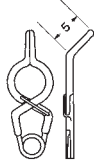
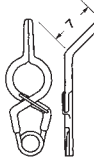
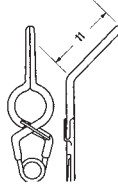
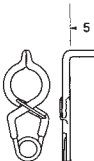
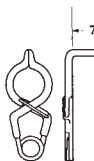
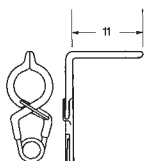
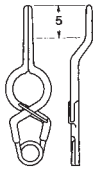
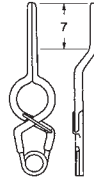
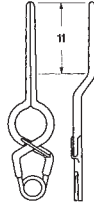
						
Cat. Nr.	41616-79	41616-91	41617-10	41617-65	41617-72	41617-78
	<b>41616-79 T</b>	<b>41616-91 T</b>	<b>41617-10 T</b>	<b>41617-65 T</b>	<b>41617-72 T</b>	<b>41617-78 T</b>
max. opening	7,9 mm	9,1 mm	10,3 mm	6,5 mm	7,2 mm	7,8 mm
Force	150 gms	150 gms	180 gms	150 gms	150 gms	180 gms
						
	41618-55	41618-56	41618-57	41618-79	41618-88	41619-00
	<b>41618-55 T</b>	<b>41618-56 T</b>	<b>41618-57 T</b>	<b>41618-79 T</b>	<b>41618-88 T</b>	<b>41619-00 T</b>
	5,5 mm	5,5 mm	5,5 mm	7,9 mm	8,8 mm	10,0 mm
	150 gms	150 gms	180 gms	150 gms	150 gms	180 gms



YASARGIL – Aneurysmen – Gefäß – Clips

YASARGIL – Aneurysm – Vessel – Clips

YASARGIL – Clips para aneurisma

YASARGIL – Clips per aneurisma

aus hochwertigem Implantat-Stahl antimagnetisch  
 in high quality Implant steel antimagnetic  
 de acero inoxidable para implantes de alta calidad, antimagnético  
 Prodotto in acciaio di alta qualità, antimagnetico

YASARGIL-STANDARD für permanenten Verschluss

YASARGIL-STANDARD for permanent closure

YASARGIL-STANDARD para cierre permanente

YASARGIL-STANDARD con chiusura permanente

## Standard

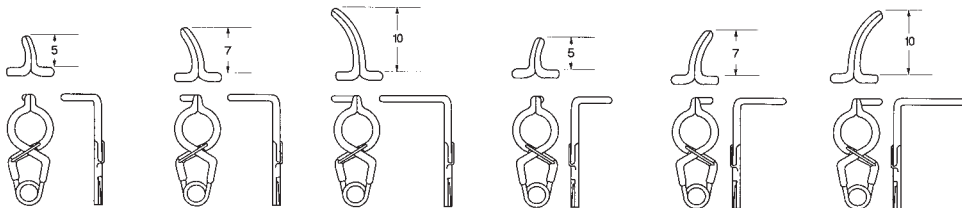

Cat. Nr.	41620-58	41620-59	41620-60	41620-61	41620-62	41620-63
	<b>41620-58 T</b>	<b>41620-59 T</b>	<b>41620-60 T</b>	<b>41620-61 T</b>	<b>41620-62 T</b>	<b>41620-63 T</b>
max. opening	5,8 mm	5,8 mm	5,8 mm	5,8 mm	5,8 mm	5,8 mm
Force	150 gms	150 gms	150 gms	150 gms	150 gms	150 gms

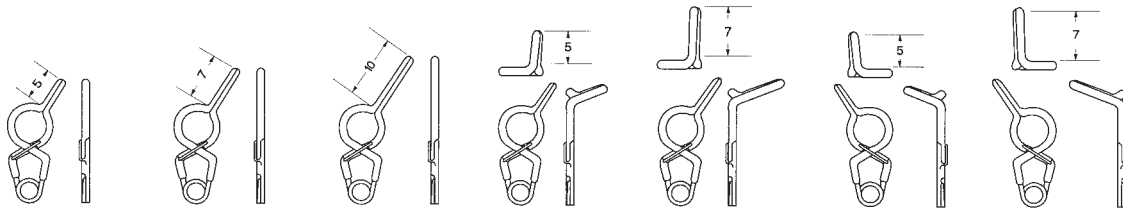

	41620-70	41620-78	41620-88	41621-58	41621-62	41622-58	41622-62
	<b>41620-70 T</b>	<b>41620-78 T</b>	<b>41620-88 T</b>	<b>41621-58 T</b>	<b>41621-62 T</b>	<b>41622-58 T</b>	<b>41622-62 T</b>
max. opening	7,0 mm	7,8 mm	8,8 mm	5,8 mm	6,2 mm	5,8 mm	6,2 mm
Force	150 gms	150 gms	150 gms	150 gms	150 gms	150 gms	150 gms

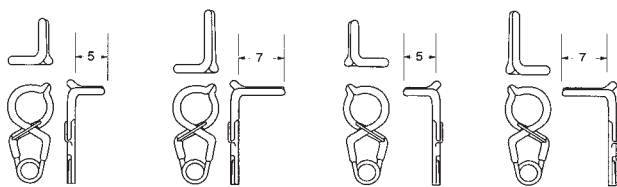

	41623-56	41624-56	41625-56	41626-56
	<b>41623-56 T</b>	<b>41624-56 T</b>	<b>41625-56 T</b>	<b>41626-56 T</b>
max. opening	5,6 mm	5,6 mm	5,6 mm	5,6 mm
Force	150 gms	150 gms	150 gms	150 gms

# YASARGIL – Aneurysmen – Gefäß – Clips

# YASARGIL – Aneurysm – Vessel – Clips

# YASARGIL – Clips para aneurisma

# YASARGIL – Clips per aneurisma

aus hochwertigem Implantat-Stahl antimagnetisch  
 in high quality Implant steel antimagnetic  
 de acero inoxidable para implantes de alta calidad, antimagnético  
 Prodotto in acciaio di alta qualità, antimagnetico







YASARGIL-STANDARD für permanenten Verschluss







YASARGIL-STANDARD for permanent closure



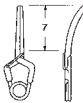

YASARGIL-STANDARD para cierre permanente

YASARGIL-STANDARD con chiusura permanente

## Mini

						
Cat. Nr.	41627-33	41627-40	41628-33	41628-40	41628-46	41629-32
	<b>41627-33 T</b>	<b>41627-40 T</b>	<b>41628-33 T</b>	<b>41628-40 T</b>	<b>41628-46 T</b>	<b>41629-32 T</b>
max. opening	3,3 mm	4,0 mm	3,3 mm	4,0 mm	4,6 mm	3,2 mm
Force	110 gms	110 gms	110 gms	110 gms	110 gms	110 gms

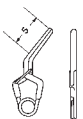
						
41629-38	41630-36	41630-38	41631-36	41631-40	41631-44	41632-36
<b>41629-38 T</b>	<b>41630-36 T</b>	<b>41630-38 T</b>	<b>41631-36 T</b>	<b>41631-40 T</b>	<b>41631-44 T</b>	<b>41632-36 T</b>
3,8 mm	3,6 mm	3,8 mm	3,6 mm	4,0 mm	4,4 mm	3,6 mm
110 gms	110 gms	110 gms	110 gms	110 gms	110 gms	110 gms

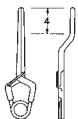
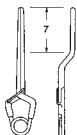
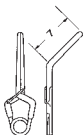
						
41633-35	41633-40	41634-35	41634-60	41634-70	41635-57	41636-45
<b>41633-35 T</b>	<b>41633-40 T</b>	<b>41634-35 T</b>	<b>41634-60 T</b>	<b>41634-70 T</b>	<b>41635-57 T</b>	<b>41636-45 T</b>
3,5 mm	4,0 mm	3,5 mm	6,0 mm	7,0 mm	5,7 mm	4,5 mm
110 gms	110 gms	130 gms	130 gms	130 gms	130 gms	130 gms

YASARGIL – Aneurysmen – Gefäß – Clips

YASARGIL – Aneurysm – Vessel – Clips

YASARGIL – Clips para aneurisma

YASARGIL – Clips per aneurisma

aus hochwertigem Implantat-Stahl antimagnetisch  
in high quality Implant steel antimagnetic  
de acero inoxidable para implantes de alta calidad, antimagnético  
Prodotto in acciaio di alta qualità, antimagnetico

YASARGIL-STANDARD für temporären Verschluss

YASARGIL-STANDARD for temporary closure

YASARGIL-STANDARD para cierre temporal

YASARGIL-STANDARD con chiusura temporanea

## Mini

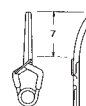

Cat. Nr.

41637-33

41637-40

41638-38

41638-46

41639-44

41640-40

max. opening  
Force

41637-33 T

41637-40 T

41638-38 T

41638-46 T

41639-44 T

41640-40 T

3,3 mm

4,0 mm

3,8 mm

4,6 mm

4,4 mm

4,0 mm

50 gms

50 gms

50 gms

70 gms

70 gms

70 gms

Anlegezange mit Rundgriff – FLEXIBEL – mit und ohne drehbarem Maulteil

Applying forceps with round shaft – FLEXIBLE – with and without Rotation

Pinzas de aplicación con mango redondo – FLEXIBLE – con y sin rotación

Posa clips con manico rotunda guaina FLESSIBILE cover sistema rotante ed non rotante

Länge		
Length		
Largo		
Lunghezza	MINI	STANDARD
70 mm	41641-07	41643-07
90 mm	41641-09	41643-09
110 mm	41641-11	41643-11

nicht drehbar  
non rotating  
sin rotación  
non rotante

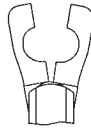

Länge		
Length		
Largo		
Lunghezza	MINI	STANDARD
70 mm	41642-07	41644-07
90 mm	41642-09	41644-09
110 mm	41642-11	41644-11

drehbar  
rotating  
rotante  
rotante

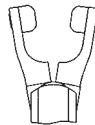

drehbar  
rotating  
rotante  
rotante

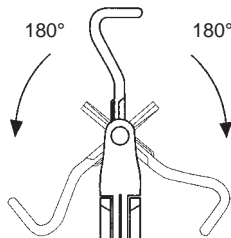

Beispiel für Drehmechanismus  
Example for Rotation  
Ejemplo de la rotación  
Esempio della rotazione

Clips drehbar im Maul  
Clips rotabile in jaw  
Clips rotabile en la boca  
Clips rotabile nel morso

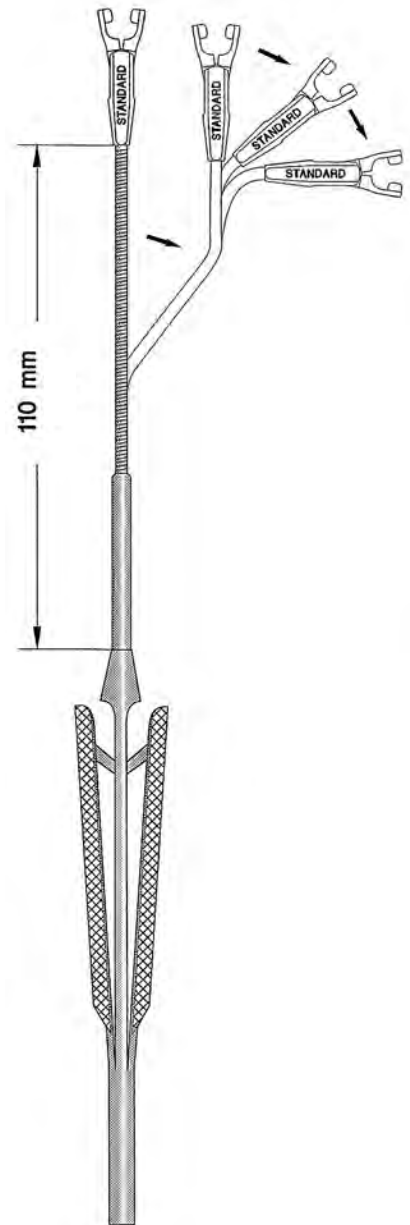

41641-07 - 41644-11

Anlegezange mit Rundgriff – starr – mit und ohne drehbarem Maulteil  
 Applying forceps with round shaft – rigid – with and without Rotation  
 Pinzas de aplicación con mango redondo – rígido – con y sin rotación  
 Posa clips con manico rotonda guaina rigida cover sistema rotante ed non rotante

Länge			nicht drehbar
Length			non rotating
Largo			sin rotación
Lunghezza	MINI	STANDARD	non rotante
70 mm	41645-07	41647-07	
90 mm	41645-09	41647-09	
110 mm	41645-11	41647-11	

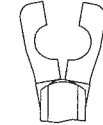

Länge			drehbar
Length			rotating
Largo			rotante
Lunghezza	MINI	STANDARD	rotante
70 mm	41646-07	41648-07	
90 mm	41646-09	41648-09	
110 mm	41646-11	41648-11	

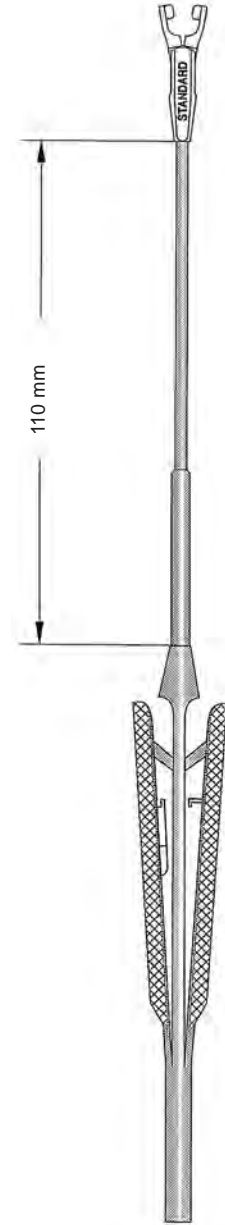
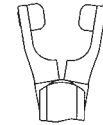

drehbar  
rotating  
rotante  
rotante

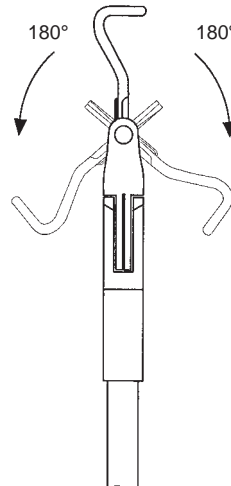

Beispiel für Drehmechanismus  
 Example for Rotation  
 Ejemplo de la rotación  
 Esempio della rotazione

Clips drehbar im Maul  
 Clips rotabile in jaw  
 Clips rotabile en la boca  
 Clips rotabile nel morso

41645-07 - 41648-11

Anlegezange mit Rundgriff – starr – mit und ohne drehbarem Maulteil  
 Applying forceps with round shaft – rigid – with and without Rotation  
 Pinzas de aplicación con mango redondo – rigido – con y sin rotación  
 Posa clips con manico rotonda guaina rigida cover sistema rotante ed non rotante

Länge		
Length		
Largo		
Lunghezza	MINI	STANDARD
70 mm	41649-07	41651-07
90 mm	41649-09	41651-09
110 mm	41649-11	41651-11

nicht drehbar  
 non rotating  
 sin rotación  
 non rotante

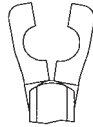

Länge		
Length		
Largo		
Lunghezza	MINI	STANDARD
70 mm	41650-07	41652-07
90 mm	41650-09	41652-09
110 mm	41650-11	41652-11

drehbar  
 rotating  
 rotante  
 rotante

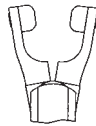

drehbar  
 rotating  
 rotante  
 rotante

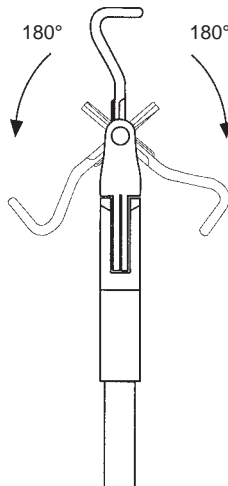

Beispiel für Drehmechanismus  
 Example for Rotation  
 Ejemplo de la rotación  
 Esempio della rotazione

Clips drehbar im Maul  
 Clips rotabile in jaw  
 Clips rotabile en la boca  
 Clips rotabile nel morso

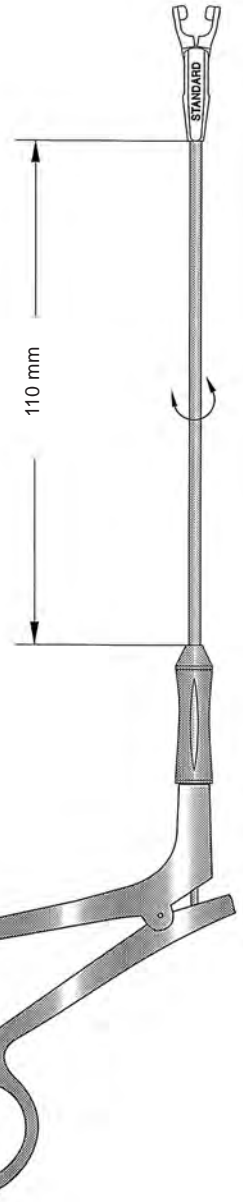

41649-07 - 41652-11

Anlegezange – mit und ohne drehbarem Maulteil

Applying Forceps – with and without Rotation

Pinzas de aplicación, con y sin rotación

Pinza posa clips, con ed senza rotazione

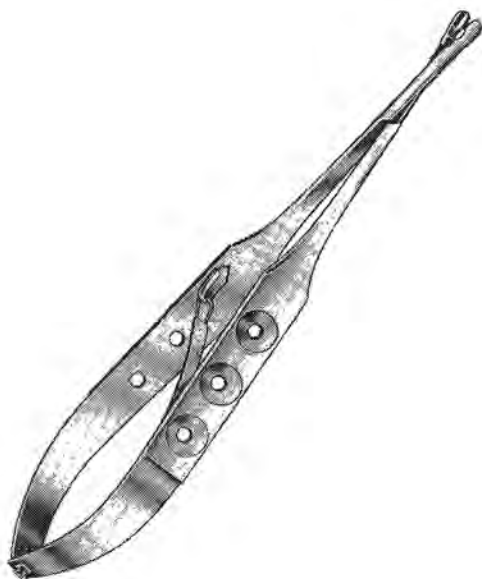

MINI	41653-18	
STANDARD	41654-18	
MINI	41655-18	drehbar / rotating rotante / rotante
STANDARD	41656-18	drehbar / rotating rotante / rotante

Anlegezange gerade, mit Sperre, Länge 18 cm, 7"  
 Applying Forceps straight, with Ratchet, Length 18 cm, 7"  
 Pinza de aplicación, con cremallera, 18 cm, 7"  
 Posa clips, retta con bloccaggio lunghezza 18 cm, 7"





Länge			
Length			
Largo			
Lunghezza	17 cm, 6 3/4"	21 cm, 8 1/4"	23 cm, 9"
MINI	41657-17	41657-21	41657-23
STANDARD	41658-17	41658-21	41658-23
MINI	41659-17	41659-21	41659-23
	drehbar / rotating / rotante / rotante		
STANDARD	41660-17	41660-21	41660-23
	drehbar / rotating / rotante / rotante		

Clips drehbar im Maul  
 Clips rotabile in jaw  
 Clips rotabile en la boca  
 Clips rotabile nel morso

Anlegezange bayonett, mit Sperre  
 Applying Forceps bayonett, with Ratchet  
 Pinza de aplicación bayoneta, con cremallera  
 Posa clips a baionetta con bloccaggio

Gefäßclips nach BIEMER  
 BIEMER Vessel Clips  
 Clips para vasos de BIEMER  
 Clips per vasi secondo BIEMER

	Maulöffnung Opening	Maullänge Length of jaws	Schließkraft Closing Force
 41661-40	Apertura de la boca Apertura del morso 4,0 mm	Largo de la boca Lunghezza del morso 6,0 mm	Fuerza de cierre Forza di chiusura 30 - 40 g (0,29 - 0,39 N)
 41661-50	5,0 mm	9,0 mm	30 - 40 g (0,29 - 0,39 N)
 41662-50	5,0 mm	9,0 mm	20 - 25 g (0,20 - 0,25 N)

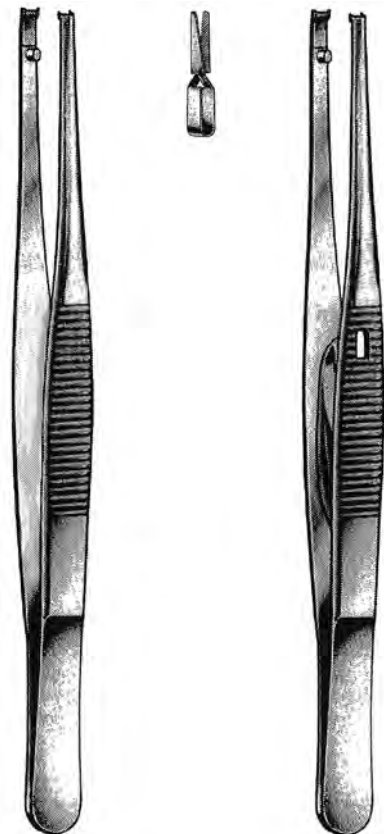

für temporären Gebrauch

gekennzeichnet durch gelb eingefärbte Federenden für Gefäße mit einem Durchmesser 0,5 - 2,0 mm

Maulinnenflächen schräg gerieft für schonendes, sicheres Festhalten der Gefäße

Der fest eingestellte Schließdruck gewährt risikofreie Anwendung

for temporary occlusion

(identified by yellow coloured spring ends) for vessel diam. 0,5 - 2,0 mm

Blade gripping surface with oblique serrations for save but careful gripping of vessels

No risk due to rigidly fixed pressure measure

para uso temporal

clips marcados con baño dorado en los resortes, para vasos con un diámetro de 0,5 - 2,0 mm

El interior de las quijadas viene con estrias finas para un agarre seguro y ciudadoso de los vasos

Debido a la calibración exacta de la fuerza de cierre se ofrece una aplicación sin riesgo

per chiusura temporanea

per vasi con Diametro 0,5 - 2,0 mm

La chiusura regolata garantisce nessun rischio

BIEMER  
41663-01

Anlegepinzette ohne Schloß,  
für Mikro-Gefäßclips  
41661-40 - 41662-50  
und  
Approximatoren  
41667-30 - 41670-50  
und  
41672-01 - 41672-04

Applying forceps without lock.  
for vessel clips  
41661-40 - 41662-50  
and  
Aproximators  
41667-30 - 41670-50  
and  
41672-01 - 41672-04

BIEMER  
41663-02

Anlegepinzette mit Schloß,  
für Mikro-Gefäßclips  
41661-40 - 41662-50  
und  
Approximatoren  
41667-30 - 41670-50  
und  
41672-01 - 41672-04

Applying forceps with lock.  
for vessel clips  
41661-40 - 41662-50  
and  
Aproximators  
41667-30 - 41670-50  
and  
41672-01 - 41672-04



Gefäßclips nach MEHDORN  
 MEHDORN Vessel Clips  
 Clips para vasos de MEHDORN  
 Clips secondo MEHDORN

für temporären Gebrauch

gekennzeichnet durch gelb eingefärbte Federenden für Gefäße mit einem Durchmesser 0,5 - 1,5 mm

Maulinnenflächen schräg gerieft für schonendes, sicheres Festhalten der Gefäße

Der fest eingestellte Schließdruck gewährt risikofreie Anwendung

for temporary occlusion

(identified by yellow coloured spring ends) for vessel diam. 0,5 - 1,5 mm

Blade gripping surface with oblique serrations for safe but careful gripping of vessels

No risk due to rigidly fixed pressure measure

para uso temporal

clips marcados con baño dorado en los resortes, para vasos con un diámetro de 0.5 - 1.5 mm

El interior de las quijadas viene con estrias finas para un agarre seguro y cuidadoso de los vasos

Debido a la calibración exacta de la fuerza de cierre se ofrece una aplicación sin riesgo

per chiusura temporanea

per vasi con Diametro 0,5 - 1,5 mm

La chiusura regolata garantisce nessun rischio



Beispiele für die variable Position des Clips

Ejemplo para la variedad de la aplicación del clip

Esempio: posizioni variabili delle clips

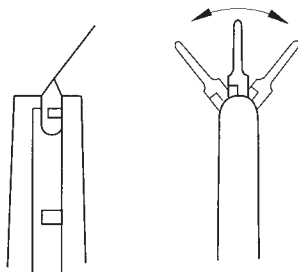

41664-10 4 x 1,0 mm



41664-14 4 x 1,4 mm



41665-10 6 x 1,0 mm



41665-14 6 x 1,4 mm

Maullänge  
 Length of jaws  
 Largo de la boca  
 Lunghezza del morso

Schließkraft  
 Closing Force  
 Fuerza del cierre  
 Forza di chiusura

10 - 15 g  
 (0,10 - 0,15 N)

15 - 20 g  
 (0,15 - 0,20 N)

10 - 15 g  
 (0,10 - 0,15 N)

15 - 20 g  
 (0,15 - 0,20 N)

MEHDORN  
 41666-00

Anlegepinzette für Mikro-  
 Gefäßclips  
 41664-10 - 41665-14

Applying Forceps for vessel  
 clips  
 41664-10 - 41665-14

Pinza de aplicación para  
 micro-clips  
 41664-10 - 41665-14

Pinza posa clips per  
 microvasi  
 41664-10 - 41665-14

Approximatoren nach Biemer-Müller  
 Approximators Biemer-Müller  
 Aproximadores de Biemer-Müller  
 Approssimatore secondo Biemer-Müller

**für temporären Gebrauch**

gekennzeichnet durch gelb eingefärbte Federenden für Gefäße mit einem Durchmesser 0,5 - 2,0 mm  
 Maulinnenflächen schräg gerieft für schonendes, sicheres Festhalten der Gefäße  
 Der fest eingestellte Schließdruck gewährt risikofreie Anwendung

**for temporary occlusion**

(identified by yellow coloured spring ends) for vessel diam. 0,5 - 2,0 mm  
 Blade gripping surface with oblique serrations for save but careful gripping of vessels  
 No risk due to rigidly fixed pressure measure

**para uso temporal**

clips marcados con baño dorado en los resortes, para vasos con un diámetro de 0,5 - 2,0 mm  
 El interior de las quijadas viene con estrias finas para un agarre seguro y cuidadoso de los vasos  
 Debido a la calibración exacta de la fuerza de cierre se ofrece una aplicación sin riesgo

**per chiusura temporanea**

per vasi con Diametro 0,5 - 2,0 mm  
 La chiusura regolata garantisce nessun rischio

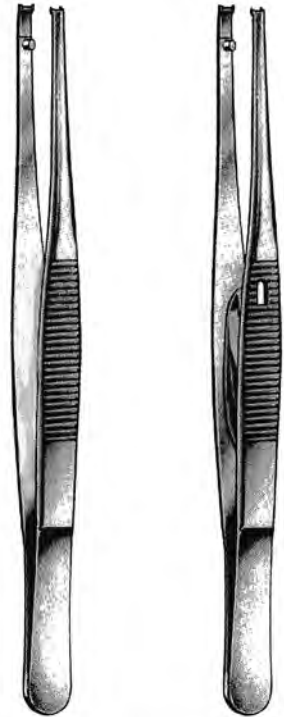

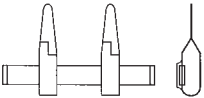
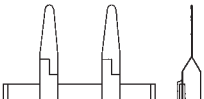
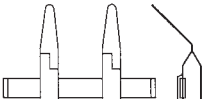
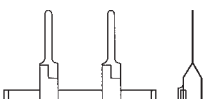
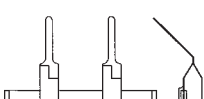
	Maulöffnung Opening	Maullänge Length of jaws	Schließkraft Closing Force
	Apertura de la boca Apertura del morso	Largo de la boca Lunghezza del morso	Fuerza del cierre Forza di chiusura
	3,0 mm	4,5 mm	30 - 40 g (0,29 - 0,39 N)
	5,0 mm	9,0 mm	30 - 40 g (0,29 - 0,39 N)
	5,0 mm	9,0 mm	30 - 40 g (0,20 - 0,25 N)
	5,0 mm	9,0 mm	30 - 40 g (0,20 - 0,25 N)
	5,0 mm	9,0 mm	30 - 40 g (0,20 - 0,25 N)

BIEMER  
41663-01

BIEMER  
41663-02

Anlegepinzette ohne  
Schloß,  
für Mikro-Gefäßclips  
41661-40 - 41662-50  
und  
Approximatoren  
41667-30 - 41670-50  
und  
41672-01 - 41672-04

Anlegepinzette mit  
Schloß,  
für Mikro-Gefäßclips  
41661-40 - 41662-50  
und  
Approximatoren  
41667-30 - 41670-50  
und  
41672-01 - 41672-04

Applying forceps without  
lock.  
for vessel clips  
41661-40 - 41662-50  
and  
Approximators  
41667-30 - 41670-50  
and  
41672-01 - 41672-04

Applying forceps with  
lock.  
for vessel clips  
41661-40 - 41662-50  
and  
Approximators  
41667-30 - 41670-50  
and  
41672-01 - 41672-04

Approximatoren nach Müller  
 Müller Approximators  
 Aproximadores de Müller  
 Approssimatore secondo Müller

für temporären Gebrauch

gekennzeichnet durch gelb eingefärbte Federenden für Gefäße mit einem Durchmesser 0,5 - 2,0 mm  
 Maulinnenflächen schräg gerieft für schonendes, sicheres Festhalten der Gefäße  
 Der fest eingestellte Schließdruck gewährt risikofreie Anwendung

for temporary occlusion

(identified by yellow coloured spring ends) for vessel diam. 0,5 - 2,0 mm  
 Blade gripping surface with oblique serrations for save but careful gripping of vessels  
 No risk due to rigidly fixed pressure measure

para uso temporal

clips marcados con baño dorado en los resortes, para vasos con un diámetro de 0,5 - 2,0 mm  
 El interior de las quijadas viene con estrias finas para un agarre seguro y cuidadoso de los vasos  
 Debido a la calibración exacta de la fuerza de cierre se ofrece una aplicación sin riesgo

per chiusura temporanea

per vasi con Diametro 0,5 - 2,0 mm  
 La chiusura regolata garantisce nessun rischio

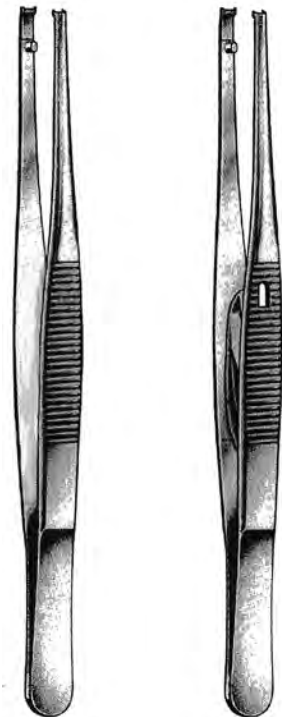

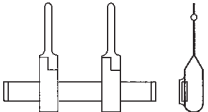
	Ø Diameter	Schließkraft Closing Force Fuerza del cierre Forza di chiusura
41672-01	1,0 mm	25 - 30 g (0,25 - 0,29 N)
41672-02	2,0 mm	25 - 30 g (0,25 - 0,29 N)
41672-03	3,0 mm	25 - 30 g (0,25 - 0,29 N)
41672-04	4,0 mm	25 - 30 g (0,25 - 0,29 N)

BIEMER  
41663-01

BIEMER  
41663-02

Anlegepinzette ohne  
Schloß,  
für Mikro-Gefäßclips  
41661-40 - 41662-50  
und  
Approximatoren  
41667-30 - 41670-50  
und  
41672-01 - 41672-04

Anlegepinzette mit  
Schloß,  
für Mikro-Gefäßclips  
41661-40 - 41662-50  
und  
Approximatoren  
41667-30 - 41670-50  
und  
41672-01 - 41672-04

Applying forceps without  
lock.  
for vessel clips  
41661-40 - 41662-50  
and  
Aproximadors  
41667-30 - 41670-50  
and  
41672-01 - 41672-04

Applying forceps with  
lock.  
for vessel clips  
41661-40 - 41662-50  
and  
Aproximadors  
41667-30 - 41670-50  
and  
41672-01 - 41672-04

Gefäßclips nach Müller  
Müller Vessel Clips  
Clips para vasos de Müller  
Clip secondo Müller

für temporären Gebrauch

Maulinnenflächen pyramidenförmig für schonendes, sicheres Festhalten der Gefäße

Der fest eingestellte Schließdruck gewährt risikofreie Anwendung

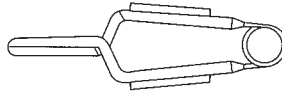

41674-50

Schließkraft  
Closing Force  
Fuerza del cierre  
Forza di chiusura

50 g

for temporary occlusion

Blade gripping surface with pyramid-like impressions for save but careful gripping of vessels

No risk due to rigidly fixed pressure measure

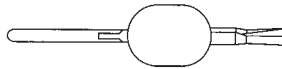

41674-80

80 g

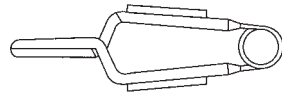

41675-50

50 g

para uso temporal

El interior de las quijadas viene en forma de pirámide para un agarre seguro y cuidadoso de los vasos.

Debido a la calibración exacta de la fuerza de cierre se ofrece una aplicación sin riesgo.

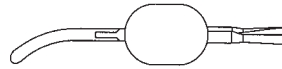

41675-80

80 g

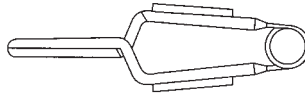

41676-50

50 g

per uso temporaneo

Morso interno con forma piramidale per garantire una chiusura sicura del vaso

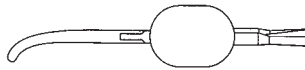

41676-80

80 g

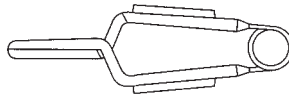

41677-50

50 g

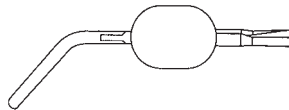

41677-80

80 g

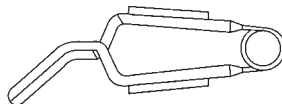

41678-50

50 g



41678-80

80 g

Approximator nach Biemer  
 Biemer Approximator  
 Aproximadores de Biemer  
 Approssimatore secondo Biemer

für Mikro-Gefäßanastomosen im oberflächlichen Bereich

Maulinnenflächen schräg gerieft für schonendes, sicheres Festhalten der Gefäße

Der fest eingestellte Schließdruck gewährt risikofreie Anwendung

Der Abstand zwischen den Clips ist durch einfaches Verschieben einzustellen und wird durch Verkanten fixiert

for micro vessel anastomosis in the superficial range

Blade gripping surface with oblique serrations for save but careful gripping of vessels

No risk due to rigidly fixed pressure measure

Adjustable distance between the clips and automatic fixation by tilting

para micro-anastomosis en la superficie

El interior de la quijada viene con estrias finas para un agarre seguro y cuidadoso de los vasos.

Debido a la calibración exacta de la fuerza de cierre se ofrece una aplicación sin riesgo.

El espacio entre los clips se logra fácilmente por el desplazamiento.

per micro vasi anastomosi sulla parte della superficie

Parte interna del morso è leggermente striata obliqua per ottenere la presa sulla superficie del vaso.

La chiusura regolata garantisce nessun rischio.

Lo scorrimento delle due clips viene regolato con semplice movimento che consente una chiusura ottimale.

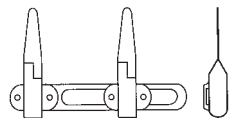

41679-25

Schließkraft  
 Closing Force  
 Fuerza de cierre  
 Forza di chiusura

25 - 30 g  
 (0,25 - 0,29 N)



BIEMER  
 41680-00

Anlegepinzette für Gefäß-  
 Approximator nach BIEMER

Applying forceps for BIEMER  
 vessel approximator

Pinza de aplicación para  
 aproximadores de BIEMER

Pinza posa clips per vasi  
 approssimatori secondo  
 BIEMER



LEYLA Retraktor System  
 LEYLA Retractor System  
 Separador de sistema LEYLA  
 LEYLA Sistema di fissaggio

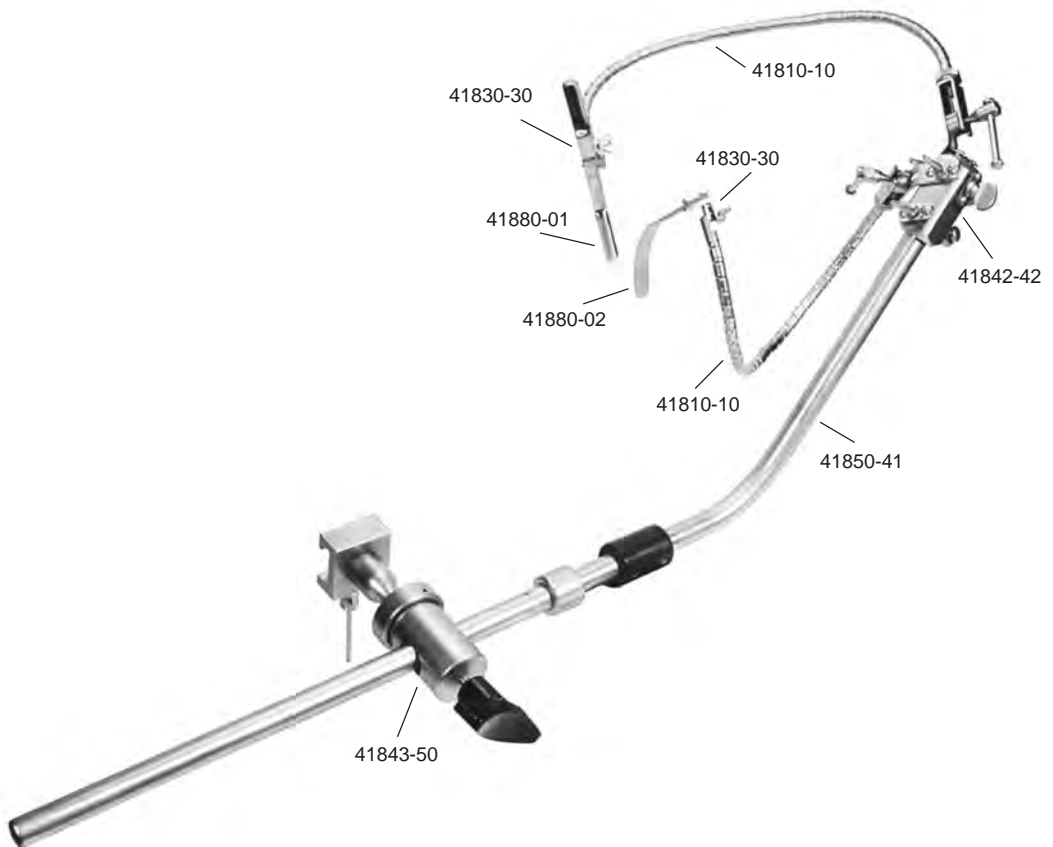

- 41802-00 LEYLA-Retraktor-System zum Fixieren am OP-Tisch komplett, bestehend aus:  
 LEYLA Self-Retraining Retractor for fixation to operating table, complete, consisting of:  
 Separador LEYLA para fijacion a la mesa de operaciones, completo, compuesto de:  
 LEYLA Sistema di fissaggio al tavolo operatorio, composto da:
- |          |  |          |   |
|----------|--|----------|---|
| 41843-50 | Kugelgelenkkloben (1x)<br>ball and socket joint (1x)<br>articulacion esferica (1x)<br>giunto per fissare (1x)        | 41830-30 | Spatelhalter für flache Spatel (2x)<br>support for flat brain spatula (2x)<br>soporte para espátulas cerebrales planas (2x)<br>sostegno per spatole piatte (2x) |
| 41850-41 | starrer Haltearm (1x)<br>rigid holding rod (1x)<br>brazo de fijación rígido (1x)<br>braccio di fissaggio rigido (1x) | 41880-01 | CUSHING Hirnspatel (1x)<br>CUSHING brain spatula (1x)<br>CUSHING espátula para cerebro (1x)<br>CUSHING spatola cerebrale (1x)                                   |
| 41842-42 | Kupplungskopf (1x)<br>coupling head (1x)<br>cabeza de acoplamiento (1x)<br>giunto per combinare (1x)                 | 41880-02 | CUSHING Hirnspatel (1x)<br>CUSHING brain spatula (1x)<br>CUSHING espátula para cerebro (1x)<br>CUSHING spatola cerebrale (1x)                                   |
| 41810-10 | flexibler Spannarm (2x)<br>flexible arm, only (2x)<br>brazo flexible, suelto (2x)<br>braccio flessibile, solo (2x)   |          |   |

LEYLA Retraktor System  
 LEYLA Retractor System  
 Separador de sistema LEYLA  
 LEYLA Sistema di fissaggio



41843-50 Kugelgelenkkloben  
 zum Befestigen an der OP-Tischschiene und zur Aufnahme  
 des Haltearms 41850-41  
 ball and socket joint  
 for fixation of holding rod 41850-41 at the operating table  
 articulation esferica, para sujetar el brazo de soporte rigido  
 sobre la mesa de operaciones 9 x 32 mm  
 giunto per fissare il braccio, articolato 9 x 32 mm

41850-41 starrer Haltearm, auseinandernehmbar, zur Fixation im  
 Kugelgelenkkloben 41843-50 und zur wahlweisen  
 Aufnahme der Kupplungsköpfe 41842-42, 41842-44  
 und 41842-46  
 holding rod, detachable, for fixation in ball and socket joint  
 41843-50 and to hold a desired coupling head  
 41842-42, 41842-44 or 41842-46  
 brazo de soporte rigido, desmontable, para fijacion a la  
 articulacion esferica 41843-50 y opcionalmente a las  
 cabezas 41842-42, 41842-44 y 41842-46  
 braccio di sostegno rigido, per fissaggio al giunto 41843-50  
 e dei giunti 41842-42, 41842-44 e 41842-46



41842-42 Kupplungskopf, zur Aufnahme von max. 5 flexiblen  
 Spannarmen 41810-10  
 coupling head to hold 5 flexible arms 41810-10  
 cabeza de acoplamiento para fijar hasta 5 brazos flexibles  
 giunto per combinare 5 bracci

41842-44 Kupplungskopf, drehbar, zur Aufnahme von 1 flexiblen  
 Spannarm 41810-10  
 coupling head, turnable, to hold 1 flexible arm 41810-10  
 acoplamiento, girable y se puede fijar en todas las posturas  
 para sujetar un brazo flexible 41810-10  
 giunto per combinare, rotabile, per sostegno del braccio  
 41810-10

41842-46 Kupplungskopf, seitlich offen zur Aufnahme von 1 flexiblen  
 Spannarm 41810-10  
 coupling head, lateral open, to hold 1 flexible arm 41810-10  
 acoplamiento, abierto al lado, para un brazo flexible  
 41810-10  
 giunto per fissare il braccio, per 41810-10



LEYLA Retraktor System  
 LEYLA Retractor System  
 Separador de sistema LEYLA  
 LEYLA Sistema di fissaggio



41801-01 Hirnspatelhalter, flexibel, für 1 flachen Spatel, komplett, bestehend aus:  
 brain retractor, flexible, for 1 flat spatula, complete, consisting out of:  
 separador autorententivo, flexible, para espátula con 1 brazo flexible,  
 completo, compuesto de:  
 divaricatore autostatico, flessibile, per spatole piatte, con 1 braccio flessibile, completo, composto da:

41810-10 flexibler Spannarm  
 flexible arm, only  
 brazo flexible, suelto  
 braccio flessibile, solo

41826-26 Fixiervorrichtung für 1 flexiblen Spannarm  
 fixation Base for 1 flexible arm  
 fijador para 1 brazo flexible  
 fissatore per 1 braccio al braccio rigido

41830-30 Spatelhalter für flache Spatel  
 support for flat brain spatula  
 soporte para espátulas cerebrales planas  
 sostegno per spatole piatte



41802-02 Hirnspatelhalter, flexibel für 2 flache Spatel, komplett, bestehend aus:  
 brain retractor, flexible, for 2 flat spatulas, complete, consisting out of:  
 separador autorententivo, flexible, para 2 espátulas planas con 2 brazos flexibles, completo, compuesto de:  
 divaricatore autostatico, flessibile, per spatole piatte, con 2 bracci flessibili, completo, composto da:

41810-10 flexibler Spannarm (2x)  
 flexible arm, only (2x)  
 brazo flexible, suelto (2x)  
 braccio flessibile, solo (2x)

41822-22 Fixiervorrichtung für 2 flexible Spannarme  
 fixation Base for 2 flexible arms  
 fijador para 2 brazos al cráneo  
 fissatore per 2 bracci al cranio

41830-30 Spatelhalter für flache Spatel (2x)  
 support for flat brain spatula (2x)  
 soporte para espátulas cerebrales planas (2x)  
 sostegno per spatole piatte (2x)

LEYLA Retraktor System  
 LEYLA Retractor System  
 Separador de sistema LEYLA  
 LEYLA Sistema di fissaggio



- 41810-10 flexibler Spannarm  
 flexible arm, only  
 brazo flexible, suelto  
 braccio flessibile, solo

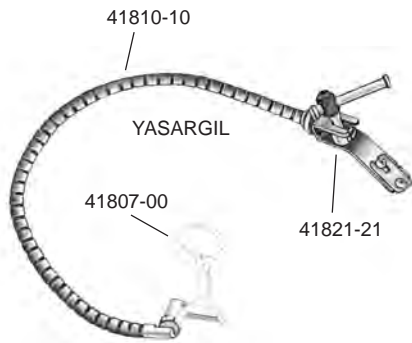

- 41803-01 Ohrspekulahalter, komplett, bestehend aus:  
 ear specula holder, complete, consisting out of:  
 soporte para espejos auriculares completo, compuesto de:  
 sostegno per specchio auricolare, completo composto da:
- 41810-10 flexibler Spannarm  
 flexible arm, only  
 brazo flexible, suelto  
 braccio flessibile, solo
- 41821-21 Fixiervorrichtung zum Befestigen an Rohrteilen bis Ø 16 mm  
 clamp for fixation on bars up to Ø 16 mm  
 fijador para 1 brazo flexible, para atornillar a tubos hasta 16 mm  
 fissatore al braccio rigido Ø 16 mm
- 41807-00 Ohrtrichterhalter, allein  
 ear specula holder, only  
 soporte para espejos auriculares, suelto  
 sostegno per specchio auricolare

LEYLA Retraktor System  
LEYLA Retractor System  
Separador de sistema LEYLA  
LEYLA Sistema di fissaggio

41821-21

Fixiervorrichtung an Rohrteilen bis  $\varnothing$  16 mm, für 1 flexiblen Spannarm  
Fixation base for mounting on bars up to  $\varnothing$ 16 mm, for 1 flexible arm  
Fijador para 1 brazo flexible, para atornillar a tubos hasta 16 mm  
Fissatore per 1 braccio al braccio rigido



41822-22

Fixiervorrichtung am Schädel für 2 flexible Spannarme  
Fixation Base for skull mounting, holding 2 flexible arms  
Fijador para 2 brazos al cráneo  
Fissatore per 2 bracci al cranio



41826-26

Fixiervorrichtung am Schädel für 1 flexiblen Spannarm  
Fixation Base for skull mounting, holding 1 flexible arm  
Fijador para 1 brazo al cráneo  
Fissatore per 1 braccio al cranio



41830-30

Halter für flache Hirnspatel  
Support for flat brain spatula  
Soporte para espátulas cerebrales planas  
Sostegno per spatole piatte



41832-32

Halter für Hirnspatel mit rundem Schaft  
Support for brain spatula with round shaft  
Soporte para espátulas cerebrales con mango redondo  
Sostegno per spatola cerebrale



Hirnspatel  
Brain Spatulas  
Espátula Cerebral  
Spatole Cerebrali



HEIFETZ  
200 mm  
8"

	Breite width ancho larghezza	Gesamtlänge total length largo total lunghezza totale
41860-14	14 mm	200 mm
41860-17	17 mm	200 mm
41860-20	20 mm	200 mm
		biegsam malleable maleable malleabili



HEIFETZ  
155 mm  
6"

	Breite width ancho larghezza	Gesamtlänge total length largo total lunghezza totale
41870-08	8 mm	155 mm
41870-11	11 mm	155 mm
41870-14	14 mm	155 mm
41870-17	17 mm	155 mm
		biegsam malleable maleable malleabili

	Breite width ancho larghezza	Gesamtlänge total length largo total lunghezza totale
41880-01	9 mm	200 mm
41880-02	12 mm	200 mm
41880-03	12 mm	250 mm
		biegsam malleable maleable malleabili



CUSHING  
200 mm, 8"

Lidsperrer  
 Eye Specula  
 Blefaróstatos  
 Blefarostati

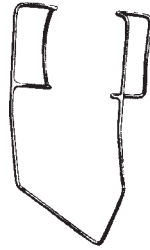

BARRAQUER (Colibri)

43101-03 3 cm, 1.2" für Kinder / children / niños / bambini  
 43101-04 4 cm, 1.6" für Erwachsene / adults / adultos / adulti



BOWMAN

43104-07  
 7 cm, 2 3/4"

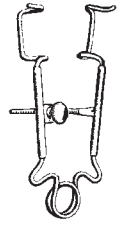

CRITCHETT

43105-06  
 7 cm, 2 3/4"



SMITH

43106-05  
 5 cm, 2"

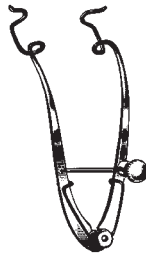

CLARK

43107-08  
 8 cm, 3 1/8"



GRAEFE

43109-07 7 cm, 2 3/4"  
 43109-09 9 cm, 3 1/2"



WEEK

43110-08  
 8 cm, 3 1/8"

rechts  
 right  
 a la derecha  
 destro

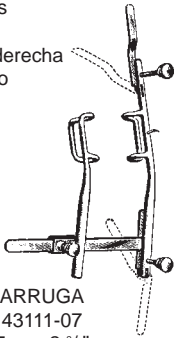

ARRUGA

43111-07  
 7 cm, 2 3/4"

links  
 left  
 a la izquierda  
 sinistro

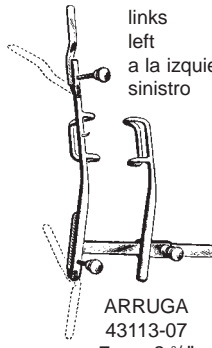

ARRUGA

43113-07  
 7 cm, 2 3/4"

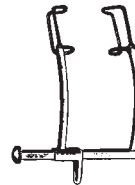

MURDOCK

43115-05  
 5 cm, 2"

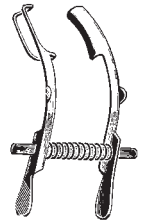

MELLINGER-AXENFELD

43121-07  
 7 cm, 2 3/4"

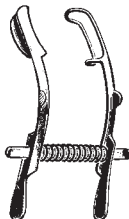

MELLINGER-AXENFELD

43123-07  
 7 cm, 2 3/4"

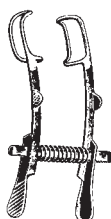

MELLINGER

43125-05 5 cm, 2"  
 43125-07 7 cm, 2 3/4"



LISTER-BURCH

43127-08  
 8 cm, 3 1/8"

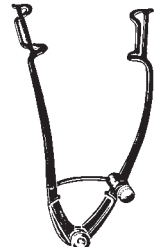

WILLIAMS

43128-08  
 8 cm, 3 1/8"

Lidsperrer, Lidplatte, Starmesser  
 Eye Specula, Lid Plate, Cataract Knives  
 Blefaróstatos, Placa para párpados, cuchillos para cataratas  
 Blefarostati, Placca per palpebre, coltelli per cataratta

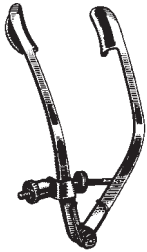

LANCASTER  
 43129-07  
 7 cm, 2 3/4"

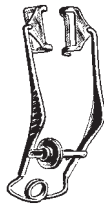

ZIEGLER  
 43130-07  
 7 cm, 2 3/4"



CASTROVIEJO  
 43132-08  
 8 cm, 3 1/8"

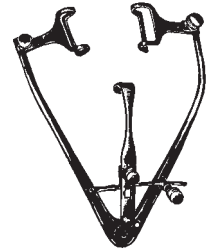

PARK  
 43133-08  
 8 cm, 3 1/8"



MUELLER  
 43135-07  
 7 cm, 2 3/4"



STEVENSON  
 43139-07  
 7 cm, 2 3/4"



LIEBERMAN  
 43140-08  
 8 cm 3 1/8"



LIEBERMAN  
 43141-08  
 8 cm 3 1/8"



JAEGER  
 43150-11  
 11 cm, 4 3/8"



GRAEFE  
 43170-00 - 43170-03  
 13 cm, 5 1/8"



43170-00



43170-01



43170-02



43170-03



DEUSCHMANN  
 43172-13  
 13 cm, 5 1/8"

Lanzenmesser, Diszisionsmesser, Irismesser, Diszisionsmesser  
 Cataract knife, keratome, Iris knife, discision knife  
 Cuchillos lanceolares y Cuchillos de discisión  
 Cheratom, bisturi p. capsule, bisturi corneale



43180-01 - 43181-03



JAEGER  
 43180-01 Fig. 1 13 cm, 5 1/8"  
 43180-02 Fig. 2 13 cm, 5 1/8"  
 43180-03 Fig. 3 13 cm, 5 1/8"

JAEGER 45°  
 43181-01 Fig. 1  
 43181-02 Fig. 2  
 43181-03 Fig. 3



BERENS  
 43183-13  
 13 cm, 5 1/8"



CASTROVIEJO  
 43185-13 13 cm  
 4 x 13 mm



GRAEFE  
 43187-13  
 13 cm, 5 1/8"



KNAPP  
 43202-01 Fig. 1  
 13 cm, 5 1/8"



43202-02 Fig. 2  
 13 cm, 5 1/8"



43202-03 Fig. 3  
 13 cm, 5 1/8"



ZIEGLER  
 43210-01 5 mm Fig. 1  
 13 cm, 5 1/8"



ZIEGLER  
 43210-02 6 mm Fig. 2  
 13 cm, 5 1/8"



ZIEGLER  
 43210-03 7 mm Fig. 3  
 13 cm, 5 1/8"



DEAN  
 43213-12  
 12,5 cm, 5"



BOWMAN  
 43214-04 13 cm  
 0,4 mm  
 13 cm, 5 1/8"



BOWMAN  
 43214-08 13 cm  
 0,8 mm  
 13 cm, 5 1/8"

Hornhautmesser, Hornhautschaber, Dissektor, Sklerotom, Goniotomiemesser  
 Corneal Scarifier, -dissector, sclerotome, goniotomy knife  
 Cuchillos para cornea, legtras corneales, esclerótomos  
 Spatole p. corneale, dissettore corneale, sclerotomo, coltello per goniotomia



WHEELER  
43218-12  
12 cm, 4 3/4"



ZIEGLER  
43221-11  
11 cm, 4 3/8"  
3,5 mm



SATO  
43226-12  
12,5 cm, 5"



TOOK  
43228-12  
12 cm, 4 3/4"



GILL  
43231-12  
12 cm, 4 3/4"



ELSCHMIG  
43233-13  
13 cm, 5 1/8"



KUHNT  
43240-01  
Fig. 1



KUHNT  
43240-02  
Fig. 2



KUHNT  
43240-03  
Fig. 3



KUHNT  
43240-04  
Fig. 4



PATON  
43245-12  
12 cm, 4 3/4"



LUNDSGAARD  
43251-12  
12 cm, 4 3/4"



GUYTON-  
LUNDSGAARD  
43253-12



BARKAN  
43256-12



SCHEIE  
43258-12



BURCH  
43262-12



PAUFIGUE  
43271-11



BARRAQUER  
43273-13



Diszisionsnadeln, Fremdkörpernadeln, Fremdkörperhohlmeißel  
 Discision Needles, Foreign-Body Instruments  
 Aguja de discisión, Instrumental para cuerpos extraños  
 Aghi per discisione, strumenti per corpi estranei



43304-12



43305-12



BOWMAN  
43308-12



BOWMAN  
43309-12



43310-13



43311-13



LEVINSON  
43314-13



FRANCIS  
43321-12



DAVIS  
43325-13



LA FORCE  
43327-12



DIX  
43330-13



ELLIS  
43331-11



WALTON  
43332-12  
1,4 mm



WALTON  
43334-12  
1,4 mm



ALVIS  
43336-12



GREEN  
43340-13



ROLLET  
43342-12

Schielhaken, Tenotomiehaken, Extraktionshaken, Tränensackhäkchen  
 Strabismus hook, lens hook, extraction hook  
 Ganchos para estrabismo, - cristalino, extracción  
 Uncino per il strabismo, uncino p. cristallino, protettori, uncini per l'iride



Fig. 1  
 GRAEFE  
 43351-01  
 13 cm, 5 1/8"



Fig. 2  
 GRAEFE  
 43351-02  
 14 cm, 5 1/2"



Fig. 3  
 GRAEFE  
 43351-03  
 15 cm, 6"



JAMESON  
 43353-13



GREEN  
 43355-13



STEVENS  
 43357-13



Fig. 1  
 ARRUGA  
 43363-01



Fig. 2  
 ARRUGA  
 43363-02



O'CONNOR  
 43370-12



WIENER  
 43372-13



WIENER  
 43373-13



ROLLET  
 43376-13



KNAPP  
 43377-13



GRAEFE  
 43380-13



GRAEFE  
 43381-13



GRAEFE  
 43383-13



BECKER  
 43386-13

Implantations Instrumente  
Instruments for Implantation  
Instrumentos para implantaciòn  
Strumenti per impianto

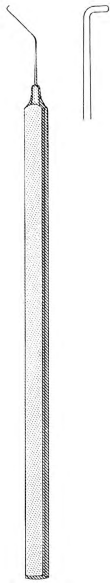

CLAYMAN  
43387-02  
11,5 cm 4 1/2"



SINSKEY  
43388-02  
11,4 cm 4 1/2"



SINSKEY  
43389-02  
12 cm 4 3/4"

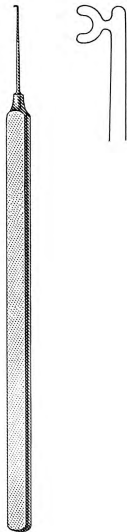

KUGLEN  
43390-05  
11,7 cm 4 5/8"

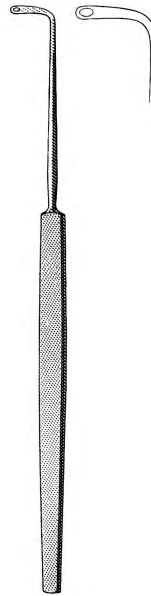

GASS  
43391-13  
14,6 cm 5 3/4"

Küretten und Löffel für Chalazion und Star  
 Scoops and Curettes for Chalazio, Cataract, and Exenteration  
 Curetas y cucharillas para chalazión, catarata y exenteración  
 Curette e cucchiari per calazio, cateratta e palpebre

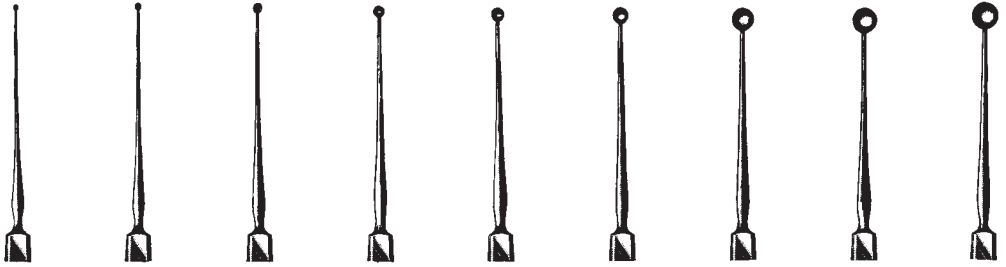

MEYHOEFER

	43402-05	43402-10	43402-15	43402-18	43402-20	43402-25	43402-35	43402-40	43402-45
Ø mm	0,5	1,0	1,5	1,8	2,0	2,5	3,5	4,0	4,5

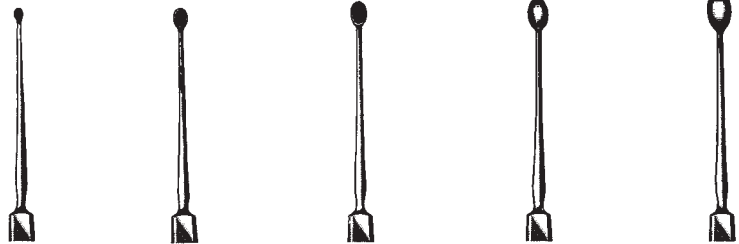

	HEBRA	HEBRA	HEBRA	HEBRA	HEBRA
	43404-10	43404-20	43404-24	43404-30	43404-35
Ø mm	1,0	2,0	2,5	3,0	3,5



AXENFELD  
43407-13



GRAEFE  
43410-01



GRAEFE  
43410-02



DAVIEL  
43412-01  
3 mm



DAVIEL  
43412-02  
4 mm

Starlöffel, Exenterationslöffel, Drahtschlingen, Starschlingen, Irisspatel, Enukleationslöffel, Wundlöffel  
 Cataract Spoon, Exenteration Scoops, Lens Scoops, Spatulas, Protectores  
 Cucharillas para Catarata-, exenteración, Asas, Espátulas, Protectores  
 Cucchiaino per cataratta- esenterazione, Anse, Spatole, Protettori



KNAPP  
43414-02



BUNGE  
43420-01



BUNGE  
43420-02



BUNGE  
43420-03



LANG  
43424-13



WEBER  
43441-01  
Fig. 1



43441-02  
Fig. 2



SNELLEN  
43443-13



WILDER  
43445-13  
Fig. 1



43447-13  
Fig. 2



ARLT



43449-01



43449-02

Cautery  
Cauter  
Cauterio

Iris  
Iride



WECKER  
43461-13



WECKER  
43462-13



CULLER  
43467-13



WELLS  
43482-20



ARRUGA  
43485-13



WADSWORTH-TODD  
43487-14

Zykloalysespatel, Fremdkörperinstrumente  
 Cyclodialysis Spatula, Foreign Body Instruments  
 Espátulas para ciclodiálisis, Instrumentos para cuerpos extraños  
 Spatole per ciclodialisi, Strumenti per corpi estranei



BANGERTER



43501-06  
6 mm



43501-10  
10 mm



43501-12  
12 mm



43511-13 - 43517-09



CASTROVIEJO  
43511-13  
1,2 x 10 mm



CASTROVIEJO  
43513-14  
1,5 x 15 mm



ELSCHNIG  
43515-14  
1,2 x 12 mm



CASTROVIEJO  
43517-09  
0,8 x 15 mm

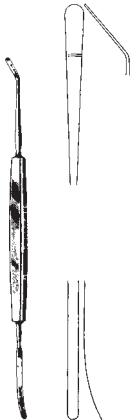

CASTROVIEJO  
43521-12  
12 cm, 4 3/4"

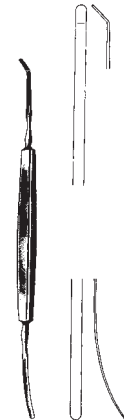

WHEELER  
43523-12  
12 cm, 4 3/4"

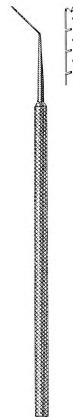

HIRSCHMAN  
43524-10  
12,5 cm, 5"



CASTROVIEJO  
43525-05 0,50 mm  
43525-07 0,75 mm  
43525-10 1,00 mm



BECHERT  
43526-12  
12,5 cm, 5"

Fremdkörperinstrumente, Meßzirkel, Kapselstanze  
 Foreign- Body Instruments, Markers, Corneoscleral punch  
 Instrumental para cuerpos extraños, Compás de la cápsula, Pinza para capsuloiridectom  
 Strumenti per corpi estranei, Marcatori, Pinza per capsula



DIX  
43542-12



DIX  
43544-12



DIX  
43546-13



DIX  
43548-13



CASTROVIEJO  
43583-07 0-20 mm  
7 cm, 2 3/4"



CONNIN-AMSLER  
43589-13



HOLTH  
43593-09

Tränenkanaldilatatoren, Sonden  
 Lachrymal Dilators-, Probes  
 Dilatadores, Estiletos para canal lacrimal  
 Dilatatori e Specilli per canale lacrimale



WILDER  
43602-01



WILDER  
43602-02



WILDER  
43602-03

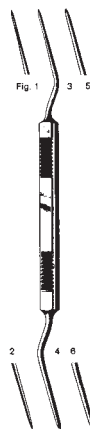
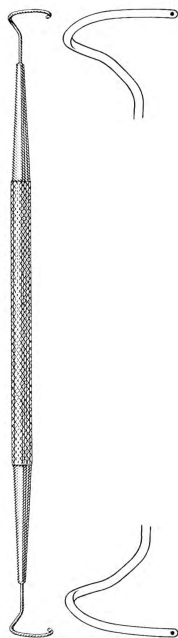

Fig. ZIEGLER  
 1/2 43605-12  
 3/4 43605-34  
 5/6 43605-56



CASTROVIEJO  
43608-12



WORST  
43609-14  
14,9 cm 5 7/8"

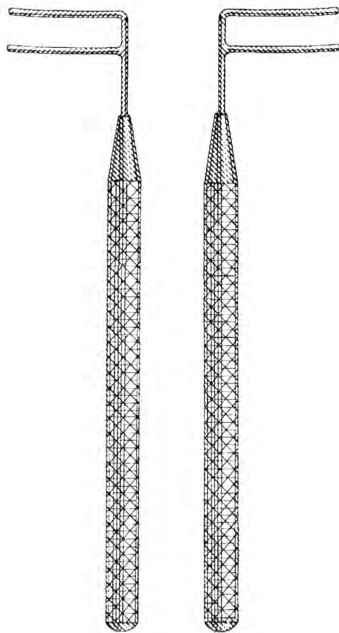

HARMS  
43610-01 43610-02  
4,8 cm 1 7/8"

geknöpft



rostfrei  
stainless steel  
acero inoxidable  
acciaio inossidabile

Fig.	BOWMAN	Ø mm
0000/000	43613-00	0,6/0,7
00/0	43614-00	0,7/0,8
0/1	43614-01	0,8/0,9
1/2	43614-12	0,9/1,1
2/3	43614-23	1,1/1,3
3/4	43614-34	1,3/1,4
4/5	43614-45	1,4/1,5
5/6	43614-56	1,5/1,6
6/7	43614-67	1,6/1,8
7/8	43614-78	1,8/1,9



Iris Pinzetten  
 Iris Forceps  
 Pinzas para iris  
 Pinze per iride



GRAEFE  
 43802-07  
 7 cm (2 3/4")/1 mm

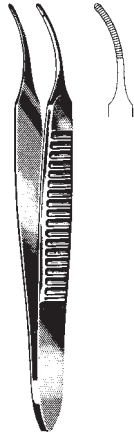

GRAEFE  
 43803-07  
 7 cm (2 3/4")/1 mm

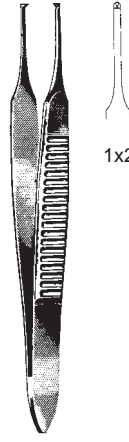

GRAEFE  
 43804-07  
 7 cm (2 3/4")/1 mm

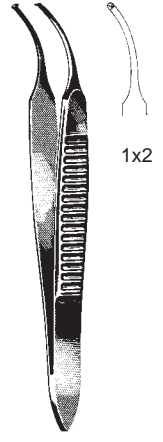

GRAEFE  
 43805-07  
 7 cm (2 3/4")/1 mm



GRAEFE  
 43810-10  
 10 cm  
 4"



GRAEFE  
 43811-10  
 10 cm  
 4"

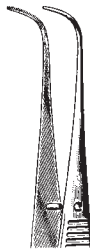

GRAEFE  
 43813-10  
 10 cm  
 4"



GRAEFE  
 43820-10  
 10 cm  
 4"

1x2



GRAEFE  
 43821-10  
 10 cm  
 4"

1x2

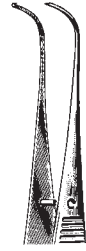

GRAEFE  
 43823-10  
 10 cm  
 4"

1x2

Iris Pinzetten  
Iris Forceps  
Pinzas para iris  
Pinze per iride



STEVENS  
43830-10  
10,5 cm, 4.1"



STEVENS  
43831-10  
10,5 cm  
4.1"

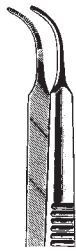

STEVENS  
43833-10  
10,5 cm  
4.1"



STEVENS  
43840-10  
10,5 cm  
4.1"



STEVENS  
43841-10  
10,5 cm  
4.1"



STEVENS  
43843-10  
10,5 cm  
4.1"

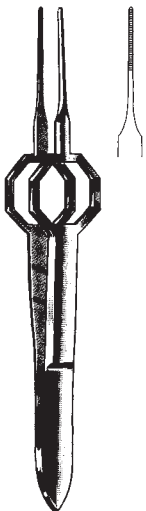

FOERSTER  
43850-08  
8,5 cm, 3.4"

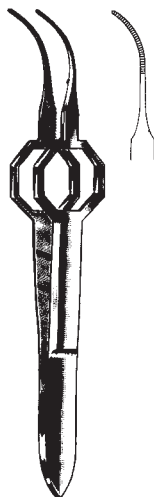

FOERSTER  
43851-08  
8,5 cm, 3.4"

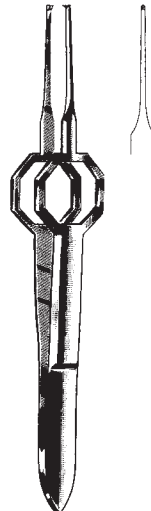

FOERSTER  
43852-08  
8,5 cm, 3.4"

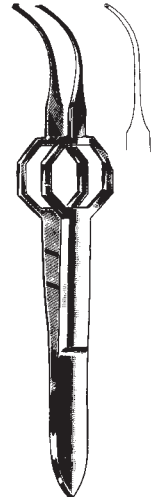

FOERSTER  
43853-08  
8,5 cm, 3.4"

Iris Pinzetten  
 Iris Forceps  
 Pinzas para iris  
 Pinze per iride

seitliche Zähne  
 lateral teeth  
 dientes laterales  
 denti laterali

Zähne abwärts  
 teeth below  
 dientes abajo  
 denti in basso

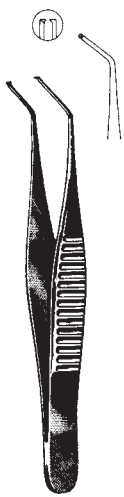

HESS  
 43855-07  
 7 cm (2 3/4")/  
 0,3 mm

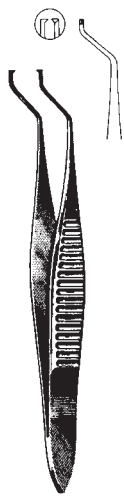

HESS  
 43857-07  
 7 cm (2 3/4")/  
 0,3 mm



GILL  
 43861-07  
 7,5 cm (3")/  
 0,3 mm



GILL-HESS  
 43863-07  
 7,5 cm (3")/  
 0,3 mm



GILL-HESS  
 43865-07  
 7,5 cm (3")/  
 0,3 mm

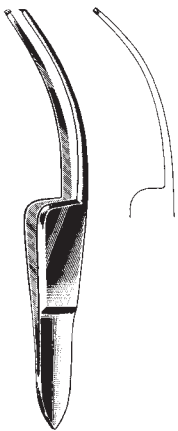

FISCHER  
 43869-07  
 7 cm (2 3/4")



BARRAQUER-KATZIN  
 43881-07  
 7 cm (2 3/4")/0,4 mm



TROUTMAN (Colibri)  
 43883-07  
 7 cm (2 3/4")/0,12 mm



BARRAQUER (Colibri)  
 43885-07  
 7 cm (2 3/4")/0,12 mm



BARRAQUER (Colibri)  
 43887-07  
 7 cm (2 3/4")/0,12 mm

Fixierpinzette, Strabismus-Pinzetten  
 Fixation forceps, Strabismus-Forceps  
 Pinza para fijación, Pinzas para estrabismo  
 Pinza per fissatrice, Pinze per strabismo

1x2



KIRBY-ARTHUR  
 43891-09 9 cm, 3 1/2"  
 0,2 mm



McCULLOUGH  
 43902-09  
 9,5 cm, 3 3/4"



McCULLOUGH  
 43903-09  
 9,5 cm, 3 3/4"

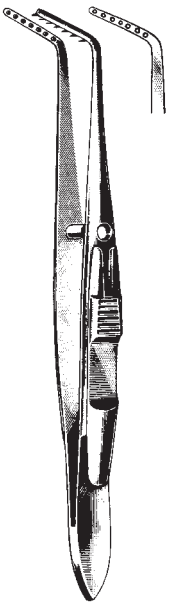

JAMESON  
 43907-10  
 L, 10 cm, 4"

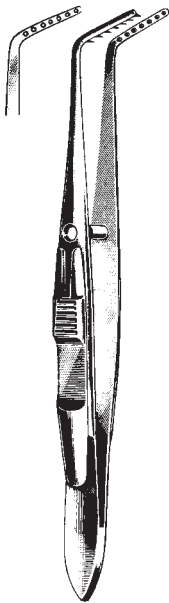

JAMESON  
 43909-10  
 R, 10 cm, 4"



BONACCOLTO  
 43914-10  
 10 cm, 4"/1,7 mm



BONACCOLTO  
 43916-10  
 10 cm, 4"/1,2 mm

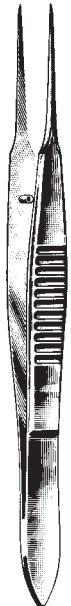

BONACCOLTO  
 43920-11  
 11 cm, 4 3/8"

Strabismus-Pinzetten, Iris Pinzetten  
 Strabismus-Forceps, Iris Forceps  
 Pinzas para estrabismo, Pinzas para iris  
 Pinze per strabismo, Pinze per iride



DASTOOR  
 43924-11  
 11 cm, 4 <sup>3</sup>/<sub>8</sub>"

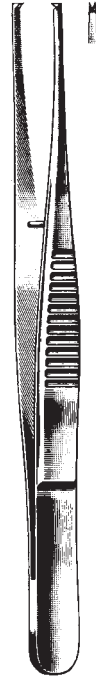

DASTOOR  
 43926-11  
 11 cm, 4 <sup>3</sup>/<sub>8</sub>"



BISHOP-HARMAN  
 43940-05 8,5 cm, 3.4"  
 0,5 mm



BISHOP-HARMAN  
 43940-08 8,5 cm, 3.4"  
 0,8 mm



BISHOP-HARMAN  
 43942-05 8,5 cm, 3.4"  
 0,5 mm

1x2



BISHOP-HARMAN  
 43942-08 8,5 cm, 3.4"  
 0,8 mm

1x2

Iris Pinzetten, Nahtpinzetten, Muskelpinzetten  
 Iris, Suture forceps, Muscle Forceps  
 Pinzas para iris, Pinza para sutura, Pinzas musculares  
 Pinze per iride, Pinza per sutura, muscolari

mit Führungsstift  
 with guide pin  
 con perno guida  
 con perno di guida

ohne Führungsstift  
 without guide pin  
 sin perno guida  
 senza perno di guida



MOD. BONN  
 43944-07  
 7 cm, 2 3/4"  
 0,12 mm



MOD. BONN  
 43946-07  
 7 cm, 2 3/4"  
 0,12 mm



MOD. BONN  
 43948-10  
 10 cm, 4"  
 0,12 mm



MOD. TÜBINGEN  
 43950-10  
 10 cm, 4"



MOD. BONN  
 43952-10  
 10 cm, 4"/0,12 mm



MOD. TÜBINGEN  
 43953-10  
 10 cm, 4"

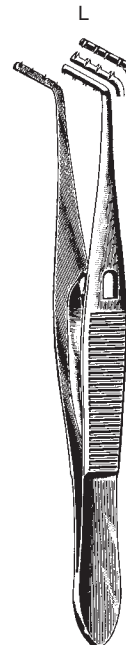

PRINCE  
 43955-10  
 10 cm, 4"

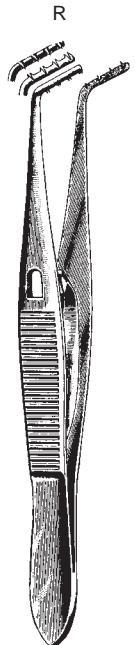

PRINCE  
 43956-10  
 10 cm, 4"



Muskelpinzetten, Fixationspinzetten  
 Muscule Forceps, Fixation Forceps  
 Pinzas musculares, Pinzas para fijación  
 Pinze muscolari, Pinze per fissaggio

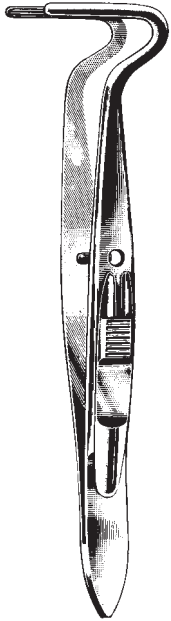

BERKE  
 44015-20 - 44015-27  
 10 cm, 4"

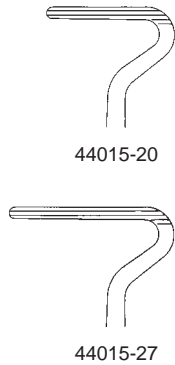

1x2  
 TROUTMAN  
 44017-08 8,5 cm, 3.4"  
 0,8 mm



ELSCHNIG  
 44046-11  
 11 cm, 4 3/8"



GRAEFE  
 44050-11 - 44052-11  
 11 cm, 4 3/8"



44050-11



44052-11  
 mit Sperre  
 with catch  
 con cierre  
 c. cremagliera



LESTER  
 44054-09  
 9 cm, 3 1/2"



Fixierpinzetten, Kapselpinzette  
 Fixation forceps, capsular forceps  
 Pinzas para fijación, Pinzas capsulares  
 Pinze fissatrici, Pinze per capsulari



1x1

CASTROVIEJO  
 44066-09  
 9 cm, 3 1/2"



1x1

CASTROVIEJO  
 44067-09  
 9 cm, 3 1/2"



2x2

CASTROVIEJO  
 44068-09  
 9 cm, 3 1/2"

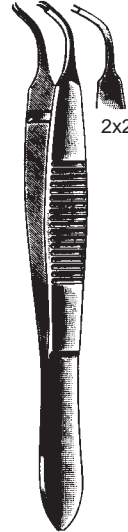

2x2

CASTROVIEJO  
 44069-09  
 9 cm, 3 1/2"



BARRAQUER  
 44074-10  
 10 cm, 4"

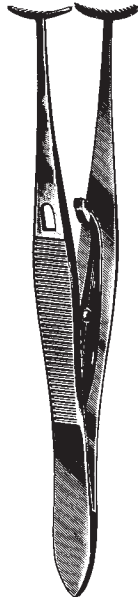

GREEN  
 44076-05 - 44078-10  
 10 cm, 4"



44076-05 5 mm      44076-10 10 mm

ohne Sperre  
 without catch  
 sin cierre  
 senza cremagliera



44078-05 5 mm      44078-10 10 mm

mit Sperre  
 with catch  
 con cierre  
 con cremagliera



GILL-ARRUGA  
 44101-07  
 7,5 cm, 3"

Kapselpinzetten  
 Capsular Forceps  
 Pinzas capsulares  
 Pinze capsulare



TERSON  
 44103-09  
 9 cm, 3 1/2"



KALT  
 44106-10  
 10 cm, 4"



ELSCHNIG  
 44109-10  
 10 cm, 4"



ARRUGA  
 44111-10  
 10 cm, 4"



ARRUGA  
 44114-10  
 10 cm, 4"



CASTROVIEJO  
 44115-10  
 10 cm, 4"



SCHWEIGGER  
 44117-10  
 10 cm, 4"



SCHWEIGGER  
 44119-10  
 10 cm, 4"



ELSCHNIG  
 44121-10  
 10 cm, 4"



HESS  
 44125-06  
 6 cm, 2.4"

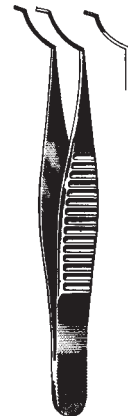

HESS  
 44127-06  
 6,5 cm, 2.6"

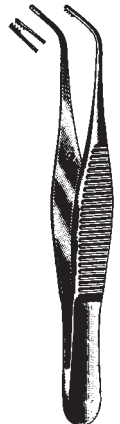

FUCHS  
 44129-07  
 7 cm, 2 3/4"

Nahtpinzetten, Fadenpinzetten  
 Suture Forceps, Tying Forceps  
 Pinzas para suturas y hilo  
 Pinze per sutura, Pinze per filo



Zahn  
tooth  
diente  
dente

CASTROVIEJO  
10 cm, 4"  
44150-01 0,12 mm  
44150-03 0,30 mm  
44150-05 0,50 mm  
44150-10 1,00 mm  
44150-15 1,50 mm

CASTROVIEJO  
10 cm, 4"  
44151-05  
44151-10  
44151-15

MOORFIELD  
44164-10  
10 cm, 4"

St. MARTIN  
44166-07  
7 cm, 2 3/4"

Mod. TÜBINGEN  
44181-10  
10 cm, 4"



1x2



PAUFIQUE  
44190-08  
8,5 cm, 3.4"

PAUFIQUE  
44202-08  
8,5 cm, 3.4"

McPHERSON  
44210-10  
10 cm, 4"

McPHERSON  
44220-10  
10 cm, 4"

Pinzetten für Chalazion und Trachom  
 Forceps for Chalazion and Trachoma  
 Pinzas de chalazión y para tracoma  
 Pinze per calazio e per trichiasi

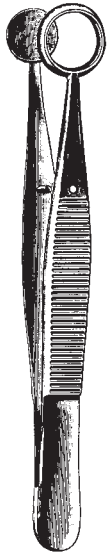

AYER  
 44240-09  
 9 cm, 3 1/2"

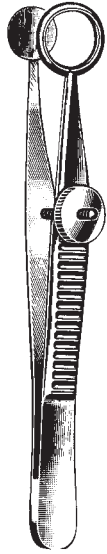

AYER  
 44242-09  
 9 cm, 3 1/2"



LAMBERT  
 44246-09  
 9 cm, 3 1/2"

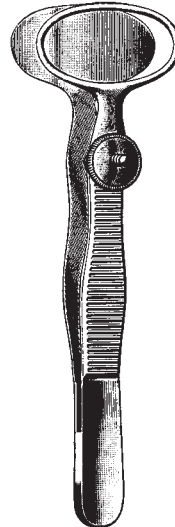

DESMARRES  
 44254-09 - 44258-09  
 9 cm, 3 1/2"



44254-09 20 mm  
 Fig. 1

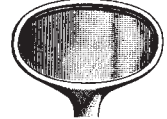

44256-09 24 mm  
 Fig. 2

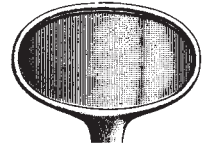

44258-09 32 mm  
 Fig. 3

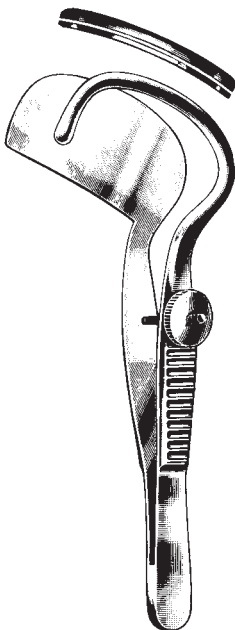

SNELLEN  
 44265-10 10 cm, 4"

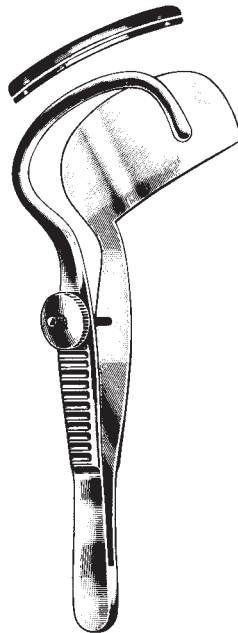

SNELLEN  
 44267-10 10 cm, 4"

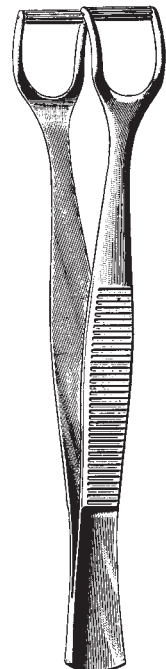

KNAPP-LUER  
 44274-11 11 cm, 4 3/8"

Augenkanülen  
 Eye Cannulas  
 Cánulas oculares  
 Cannule oculistiche



LACRIMAL  
 44300-00  
 straight

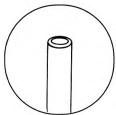

LACRIMAL  
 44301-00  
 curved

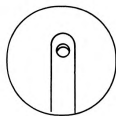

McIntyre  
 44310-00  
 straight

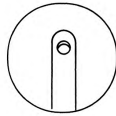

McIntyre  
 44311-00  
 curved



Air Injection  
 44320-00 27 gauge  
 44330-00 30 gauge



JENSEN  
 44340-00 23 gauge  
 44350-00 25 gauge

Spül- und Saugkanülen, Augenkanülen  
Irrigation and Aspiration Cannulas, Eye Cannulas  
Cánulas de irrigación y aspiración, Cánulas oculares  
Cannule per irrigazione ed aspirazione, Cannule oculistiche



BISHOP-HARMON

- 44370-00 complete
- 44371-00 silicone bulb
- 44372-00 adaptor
- 44373-00 19 gauge cannula
- 44374-00 21 gauge cannula

Augenkanülen, Tonometer  
 Eye Cannulas, Tonometer  
 Cánulas oculares, Tonómetro  
 Cannule oculistiche, Tonometro

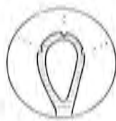

SHEETS  
 44380-00



SIMCOE  
 44390-00



SCHIOETZ  
 44404-00      44406-00  
 Skala          gerade          schräg  
 scale          straight      oblique  
 escala          recta          oblicua  
 scala          retta          obliqua

Augenmagnet, Cilienpinzetten  
 Eye Magnet, Cilia Forceps  
 Imàn para cuerpos extraños, Pinzas depilatorias  
 Calamita per corpi estranei, Pinze depilatorie



REDA  
 44408-00



BEER  
 44420-09  
 9 cm, 3 1/2"

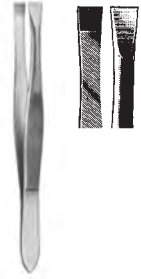

DOUGLAS  
 44422-09  
 9 cm, 3 1/2"



LITTAUER  
 44424-08  
 8,5 cm, 3.4"



BARRAQUER  
 44425-10  
 10,5 cm, 4.1"



REDA  
 44426-09  
 9 cm, 3 1/2"



GRADLE  
 44428-09  
 9,5 cm, 3 3/4"









Ohrspekula  
Ear Specula  
Espéculos auriculares  
Specoli auricolari



POLITZER  
45009-00  
Set = 3

Innen Ø  
○ = 2 mm  
45009-02

○ = 3 mm  
45009-03

○ = 4 mm  
45009-04



HARTMANN  
45010-00  
Set = 4

Innen Ø  
○ = 2 mm  
45010-20

○ = 3 mm  
45010-30

○ = 4,5 mm  
45010-45

○ = 5,5 mm  
45010-55

○ = 6,5 mm  
45010-65

○ = 7,5 mm  
45010-75



HARTMANN  
45011-00  
Set 3-7 mm

schwarz  
black  
negro  
nero

Innen Ø  
○ = 3 mm  
45011-03

○ = 4 mm  
45011-04

○ = 5 mm  
45011-05

○ = 7 mm  
45011-07

○ = 8 mm  
45011-08



TOYNBEE  
45012-00  
Set = 3

Innen Ø  
○ = 4 mm  
45012-40

○ = 5,5 mm  
45012-55

○ = 6,5 mm  
45012-65

○ = 7,5 mm  
45012-75



GRUBER, rund  
45014-00  
Set = 4

Innen Ø  
○ = 4,5 mm  
45014-45

○ = 5,5 mm  
45014-55

○ = 6,5 mm  
45014-65

○ = 7,5 mm  
45014-75



GRUBER, oval  
45015-00  
Set = 4

Innen Ø  
○ = 4,5 mm  
45015-45

○ = 5,5 mm  
45015-55

○ = 6,5 mm  
45015-65

○ = 7,5 mm  
45015-75



BOUCHERON  
45018-00  
Set = 4

Innen Ø  
○ = 5 mm  
45018-50

○ = 6 mm  
45018-60

○ = 7 mm  
45018-70

○ = 8 mm  
45018-80

Ohrspekula  
Ear Specula  
Espéculos auriculares  
Specoli auricolari

○  
45020-01  
Ø 3 mm

○  
45020-02  
Ø 4 mm

○  
45020-03  
Ø 5 mm

○  
45020-04  
Ø 6 mm

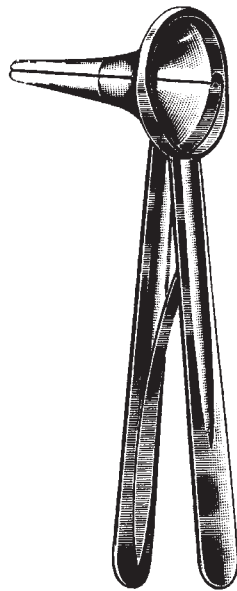

RICHNAU-HOLMGREN

Ohrspekula  
Ear Specula  
Espéculos auriculares  
Specoli auricolari

6,5 mm



45030-06

7,5 mm



45030-07

8,2 mm



45030-08

10 mm



45030-10

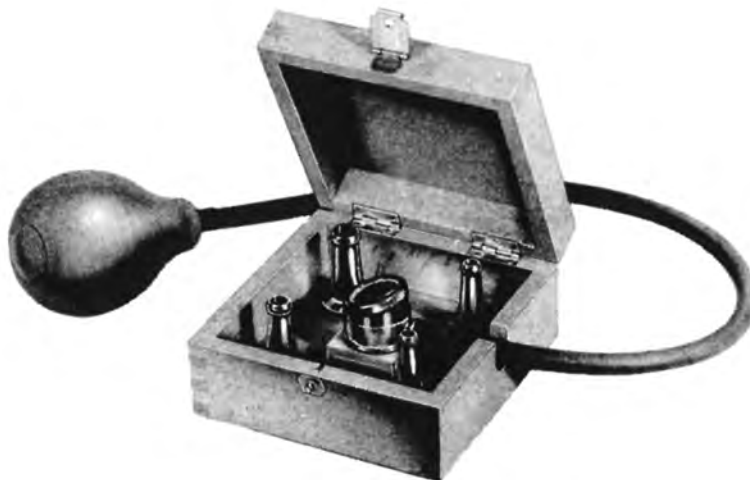

BRUENINGS  
45030-04  
compl.

Komplett bestehend aus:  
4 Spekula, Saugkammer mit  
Gebläse, Holzetui

Complete consisting of:  
4 specula, suction head and rubber  
tube with bulb, wooden case

Compuesto de:  
4 espéculos, cámara de aspiración,  
insuflador de goma, en estuche de  
madera

Composta da:  
4 specoli, camera aspirante con  
soffiatrice, scatola di legno

Ersatzteile / spare parts /  
repuestos / pezzi di ricambio

**45036-09**

Lupe / Magnification glass /  
lupa / lente d'ingrandimento

**45036-10**

Saugpumpe / rubber ball /  
pera de goma / soffiatrice di gomma

Ohrspekula  
Ear Specula  
Espéculos auriculares  
Specoli auricolari



6,5 mm Ø



45036-06



7 mm Ø



45036-07



8 mm Ø



45036-08

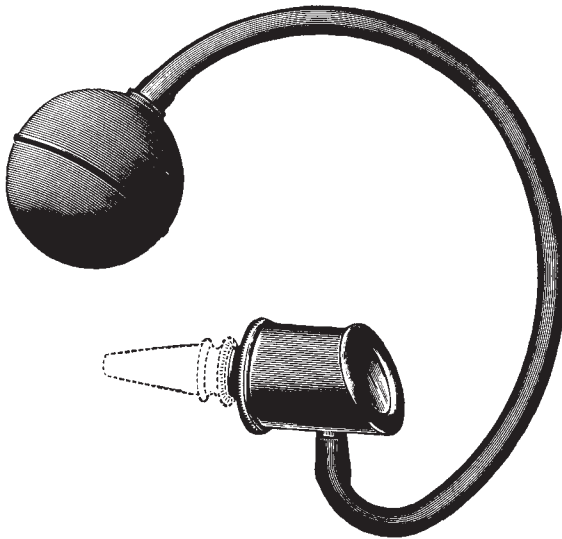

SIEGLE  
45036-03  
compl.

Komplett bestehend aus:  
Ohrspekulum, 3 Spekula, 1 Gebläse

Complete consisting of:  
Ear Specula, 1 rubber tube with bulb

Compuesto de:  
Otoscopio con 3 espéculos, insuflador y tubo

Composta da:  
Otoscopio con 3 specoli e 1 insufflatore con tubo

Stimmgabeln  
Tuning Forks  
Diapasones  
Diapason

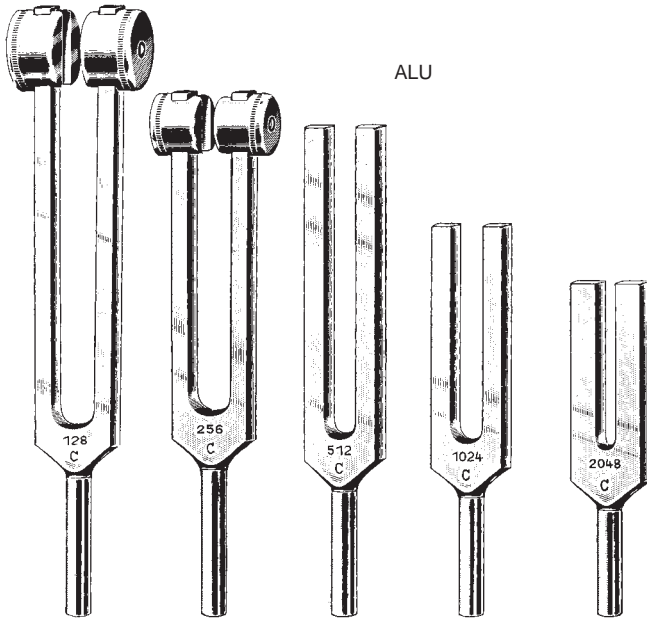

ALU

45060-01  
C 128

45060-02  
C<sup>1</sup> 256

45060-03  
C<sup>2</sup> 512

45060-04  
C<sup>3</sup> 1024

45060-05  
C<sup>4</sup> 2048



45061-00  
compl.

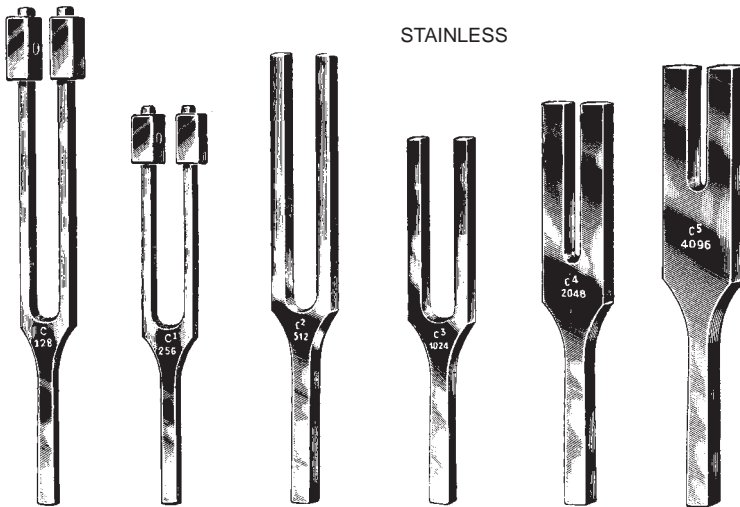

STAINLESS

45070-01  
C 128

45070-02  
C<sup>1</sup> 256

45070-03  
C<sup>2</sup> 512

45070-04  
C<sup>3</sup> 1024

45070-05  
C<sup>4</sup> 2048

45070-06  
C<sup>5</sup> 4096

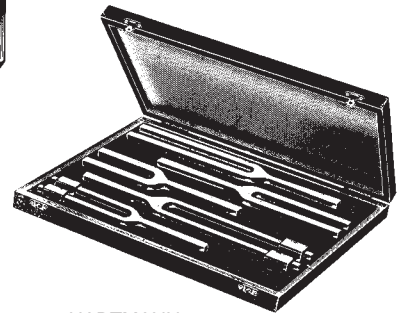

HARTMANN  
45071-00  
compl.



Stimmgabeln  
 Tuning Forks  
 Diapasones  
 Diapason



45072-01  
 a¹ 440



LUCAE  
 45073-01 C 128  
 45073-02 C¹ 256  
 45073-03 C² 512  
 45073-04 C³ 1024  
 45073-05 C⁴ 2048  
 45073-06 C⁵ 4096



LUCAE  
 45074-01  
 C 128



45075-00

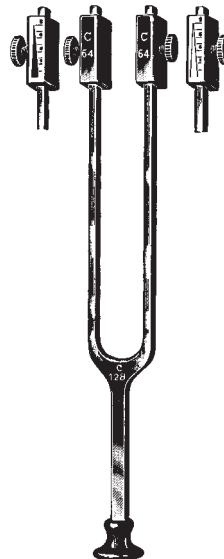

RYDEL-SEIFFERT  
 45076-01 C 128 / C 64

Lärmtrommel, Pulverbläser  
 Noise Apparatus, Powder Blowers  
 Ensordecedor, Lanzapolvo  
 Assorditore, Insoffiatori per polvere



BARANY  
 45080-00

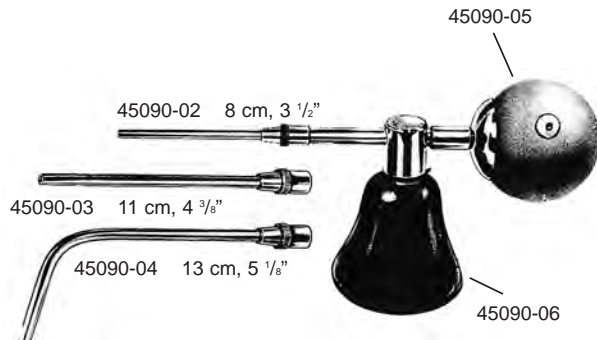

KABIERSKE  
 45090-00 compl.  
 30 cc

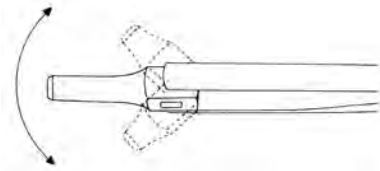

Universal  
 45090-08

Komplett mit beweglicher Düse,  
 Schraubflasche 30 ccm und Halbgebläse  
 complete with movable tube, screw bottle  
 30 ccm and rubber bulb  
 completo con tubo móvil botella con rosca  
 30 ccm y pera de goma  
 completo con tubo mobile, bottiglia con  
 filettatura 30 ccm e pera di insufflazione



Luftdusche, Ohrspritze  
 Air Bag, Ear Syringe  
 Insuflador de aire, Jeringa  
 Insoffiatore d'aria, Siringa Auricolare

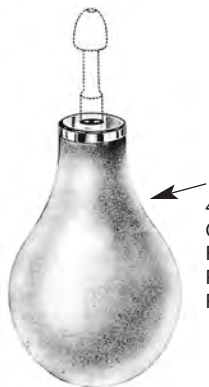

45091-02  
 Gummibirne alleine  
 Rubber bulb only  
 Pera de goma, sola  
 Pera di gomma, sola



45091-03 45091-04 45091-15  
 4 mm Ø 15 mm Ø  
 45091-17 45091-22  
 17 mm Ø 22 mm Ø

POLITZER  
 45091-00 Set  
 incl.  
 45091-03  
 45091-15  
 45091-17  
 45091-22

POLITZER  
 45091-01 Set  
 incl.  
 45091-03  
 45091-04  
 45091-15  
 45091-17  
 45091-22



ml REINER  
 compl.  
 50 45096-50  
 75 45096-75  
 100 45097-10  
 150 45097-15



45097-01

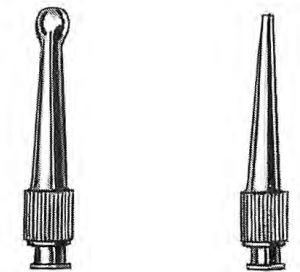

45097-02

45097-03

Spritze, Küretten  
 Syringe, Curettes  
 Jeringa, Curetas  
 Siringa, Curette



45098-01 1 ml  
 45098-02 2 ml  
 45098-05 5 ml  
 45098-10 10 ml  
 45098-20 20 ml  
 45098-50 50 ml

45099-01 1 ml  
 45099-02 2 ml  
 45099-05 5 ml  
 45099-10 10 ml  
 45099-20 20 ml  
 45099-50 50 ml



Küretten  
 Curettes  
 Curetas  
 Curette



Fig. 00      0      1      2      3      4      5

stumpf  
 blunt  
 romas  
 smusse



45109-00    45110-00    45110-01    45110-02    45110-03    45110-04    45110-05

scharf  
 sharp  
 cortantes  
 taglianti



45111-00    45112-00    45112-01    45112-02    45112-03    45112-04    45112-05

stumpf  
 blunt  
 romas  
 smusse



45114-00    45115-00    45115-01    45115-02    45115-03    45115-04    45115-05

scharf  
 sharp  
 cortantes  
 taglianti



45116-00    45117-00    45117-01    45117-02    45117-03    45117-04    45117-05

BUCK  
 14,5 cm, 5 3/4"

Ohrkatheter, Parazentese Nadeln, Ohrmesser  
 Catheters, Paracentesis Needles, Ear Knives  
 Cateteres, agujas para paracentesis, Cuchillos auriculares  
 Cateteri, Aghi per paracentesi, Coltelli auricolari

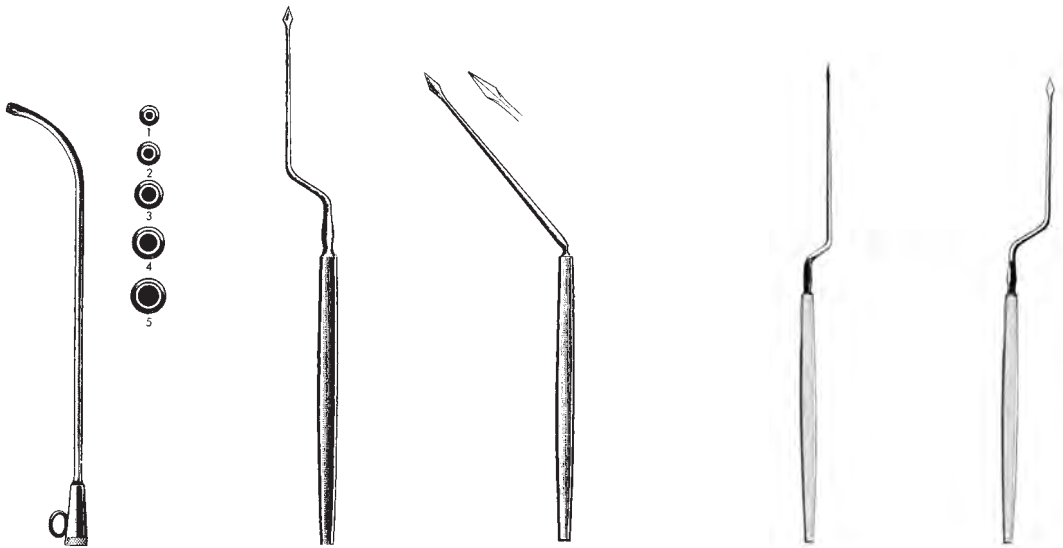

Fig. HARTMANN  
 1 45133-01 3,5 mm  
 2 45133-02 4,0 mm  
 3 45133-03 4,5 mm  
 4 45133-04 5,0 mm  
 5 45133-05 6,0 mm

POLITZER  
 45150-18  
 18 cm, 7"

POLITZER  
 45151-16  
 16,5 cm, 6 1/2"

LUCAE  
 45152-01  
 18 cm, 7"

LUCAE  
 45152-02  
 18 cm, 7"

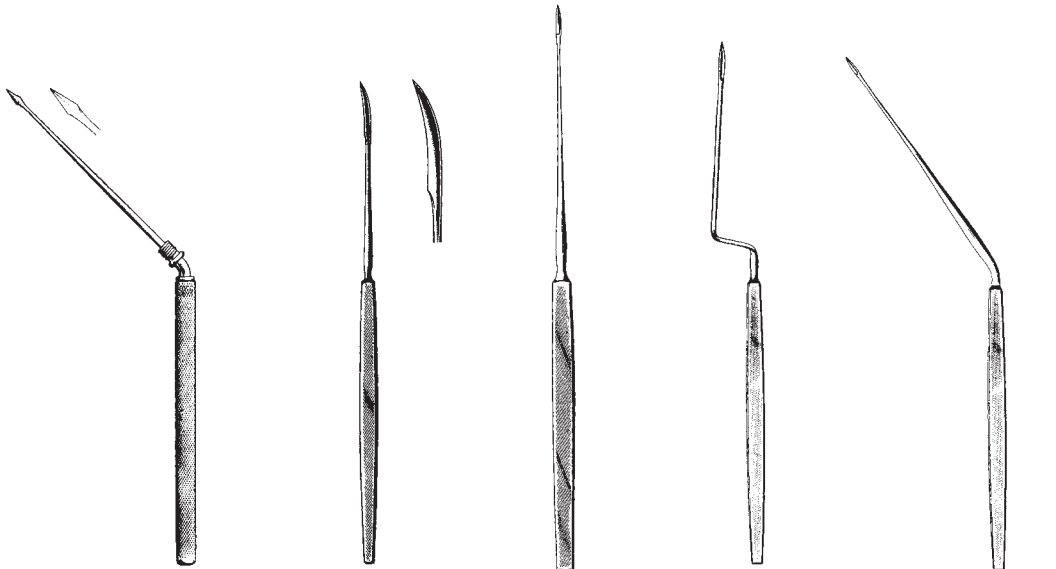

POLITZER  
 45153-16  
 16 cm, 6 1/4"

POLITZER  
 45160-15  
 15 cm, 6"

SEXTON  
 45162-18  
 18 cm, 7"

SEXTON  
 45164-17  
 17 cm, 6 3/4"

SEXTON  
 45165-17  
 17 cm, 6 3/4"

Löffel, Schlingen, Haken  
 Ear spoons, Loops, Hooklets  
 Cucharas, Asas, Ganchitos  
 Cucchiai, Anse, Uncinetti



GROSS  
 45171-12  
 12 cm, 4 3/4"



BILLEAU  
 45180-01 - 45180-03  
 16 cm, 6 1/4"



45180-01



45180-02



45180-03

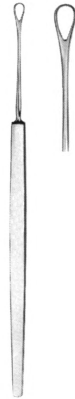

LANGENBECK  
 45181-13  
 13 cm, 5 1/8"



ZAUFAL  
 45184-16  
 16 cm, 6 1/4"

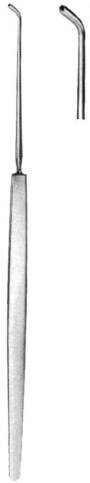

ZAUFAL-JANSEN  
 45185-15  
 15 cm, 6"



DAY  
 45190-01 - 45190-02  
 16 cm, 6 1/4"



45190-01



45190-02



WAGNER  
 45192-01 - 45192-04  
 14 cm, 5 1/2"



45192-01



45192-03



45192-02



45192-04



45192-05



45192-06



LUCAE  
 14 cm, 5 1/2"



45193-01  
 2 mm



45193-02  
 3 mm



45193-03  
 4 mm

Schlingen, Pinzetten  
 Loops, Dressing Forceps  
 Asas, Pinzas  
 Anse, Pinze

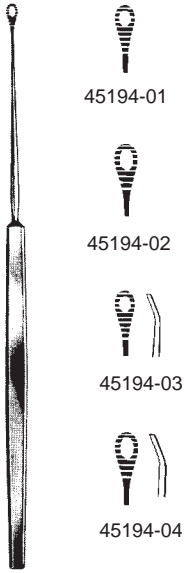

SHAPLEIGH  
 45194-01 - 45194-04  
 13 cm, 5 1/8"



WILDE (TROELTSCH)



LUCAE  
 45206-14  
 14 cm, 5 1/2"



LUCAE  
 45206-16  
 16 cm, 6 1/4"



COTTLE  
 45208-14  
 14 cm, 5 1/2"

Polypenschnürer, Ohrzängchen  
 Snares, Ear Forceps  
 Cierra-nudos, Pinzas auriculares  
 Serranodi, Pinze auricolari



KRAUSE  
 45220-16  
 16 cm, 6 1/4"

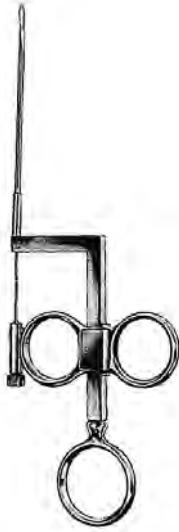

WILDE  
 45222-17  
 17 cm, 6 3/4"



45225-02  
 doz./doc./dozz.  
 0,2 mm

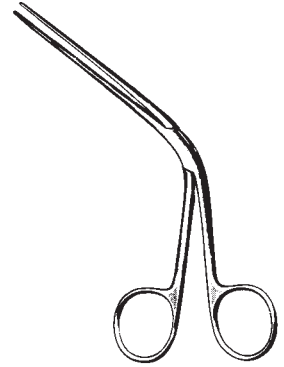

TILLEY  
 45243-14  
 14 cm, 5 1/2"



LITTAUER  
 45245-12  
 12 cm, 4 3/4"

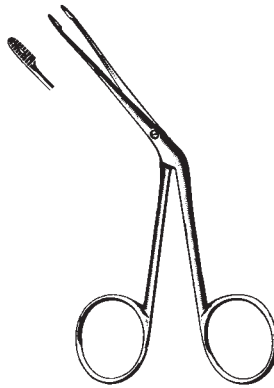

HARTMANN  
 45246-12  
 12 cm, 4 3/4"

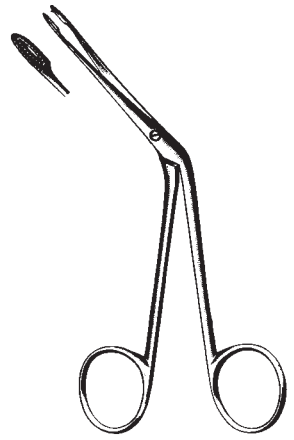

HARTMANN  
 45246-14  
 14 cm, 5 1/2"



Fremdkörperheber, Fremdkörperzängchen  
 Foreign Body Levers, Ear Polypus Forceps  
 Elevadores para cuerpos extraños, Pinzas para pólipos  
 Leve per corpi estranei, Pinze per polipi



QUIRE  
 45251-10  
 10 cm, 4"

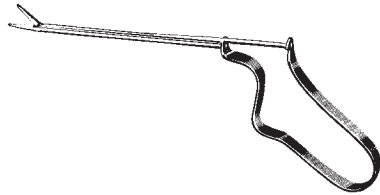

BUCK  
 45253-11  
 11 cm, 4 3/8"

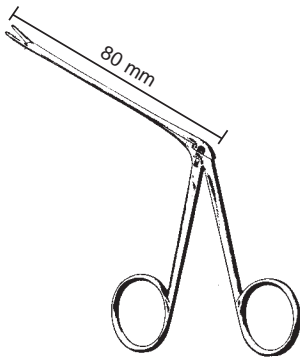

45255-08 - 45275-08



HARTMANN-WULLSTEIN  
 45255-08  
 8,5 cm, 3.4"



HARTMANN-WULLSTEIN  
 1 mm 45257-08  
 8,5 cm, 3.4"



HARTMANN  
 45261-08 8,5 cm, 3.4"  
 45261-14 14,0 cm, 5 1/2"  
 45261-16 16,0 cm, 6 1/4"



HARTMANN  
 45263-08 8,5 cm, 3.4"  
 45263-14 14,0 cm, 5 1/2"



HARTMANN  
 45265-08  
 8,5 cm, 3.4"



Ø mm HARTMANN  
 2,0 45267-20 8,5 cm, 3.4"  
 2,5 45267-25 8,5 cm, 3.4"  
 3,0 45267-30 8,5 cm, 3.4"

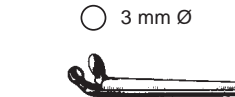

○ 3 mm Ø

HARTMANN  
 45269-30  
 8,5 cm, 3.4"



STRUEMPEL  
 45271-08 8,5 cm, 3.4"  
 2,5x5 mm



HARTMANN  
 45273-08  
 8,5 cm, 3.4"

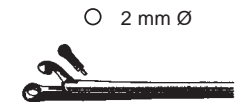

○ 2 mm Ø

HARTMANN-HOFFMANN  
 45275-08  
 8,5 cm, 3.4"

Micro-Ohrscheren, Micro-Ohrzangchen  
 Micro Ear Scissors, Micro Ear Forceps  
 Tijeras auriculares micro, Pinzas auriculares micro  
 Forbici auricolari micro, Pinze auricolari micro

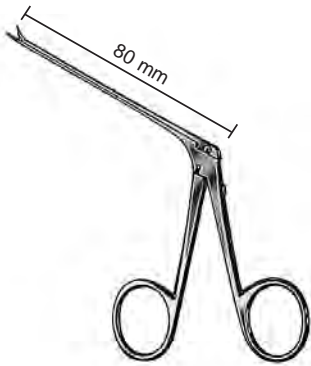

45310-40 - 45322-70



**A**  
 BELLUCCI  
 45310-40  
 micro mini  
 4 mm



**A**  
 BELLUCCI  
 45312-55  
 micro standard  
 5,5 mm

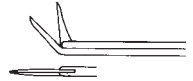

**D**  
 BELLUCCI  
 45313-55  
 micro standard  
 5,5 mm



**B**  
 BELLUCCI  
 45315-55  
 micro standard  
 5,5 mm

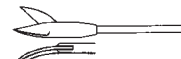

**C**  
 BELLUCCI  
 45317-55  
 micro standard  
 5,5 mm



**A**  
 SHEA  
 45320-70  
 7,0 mm



**C**  
 SHEA  
 45321-70  
 7,0 mm

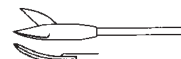

**B**  
 SHEA  
 45322-70  
 7,0 mm

- A:** gerade / straight / recta / retta  
**B:** rechts / right / derecha / destra  
**C:** links / left / izquierda / sinistra  
**D:** aufgebogen / curved up / curva in alto / curva hacia arriba  
**E:** nach unten gebogen / curved down / curva in basso / curva hacia abajo

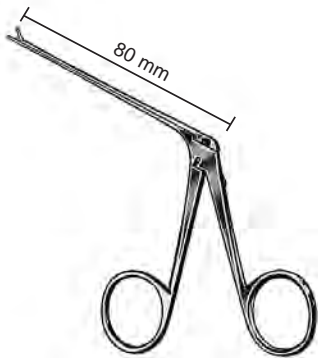

45350-40 - 45360-35



**A**  
 45350-40  
 4 mm



**A**  
 45350-70  
 7 mm



**A**  
 45352-40  
 4 mm



**C**  
 45353-60  
 6 mm



**B**  
 45355-60  
 6 mm



**D**  
 45357-40  
 4 mm



**E**  
 45359-40  
 4 mm



**A**  
 45360-35  
 3,5 mm

Micro-Ohrzängchen  
 Micro Ear Forceps  
 Pinzas auriculares micro  
 Pinze auricolari micro

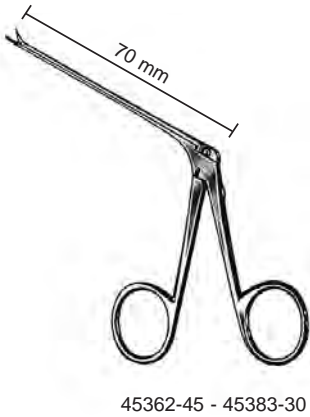

45362-45 - 45383-30



**A**  
 45362-45  
 4,5 mm



**C**  
 45363-45  
 4,5 mm



**B**  
 45365-45  
 4,5 mm

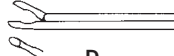

**D**  
 45367-50  
 5,0 mm

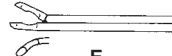

**E**  
 45369-50  
 5,0 mm



**A**  
 GREVEN  
 45370-50  
 5,0 mm

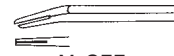

McGEE  
 45371-40  
 0,8x4,0 mm



COS  
 45373-30  
 1,8x0,8x3,0 mm



JUERS  
 45375-60  
 6,0 mm



JUERS  
 45377-60  
 6,0 mm



**C**  
 HAUGH  
 45381-30  
 45° 3 mm



**B**  
 HAUGH  
 45383-30  
 45° 3 mm

- A:** gerade / straight / recta / retta  
**B:** rechts / right / derecha / destra  
**C:** links / left / izquierda / sinistra  
**D:** aufgebogen / curved up / curva in alto / curva hacia arriba  
**E:** nach unten gebogen / curved down / curva in basso / curva hacia abajo

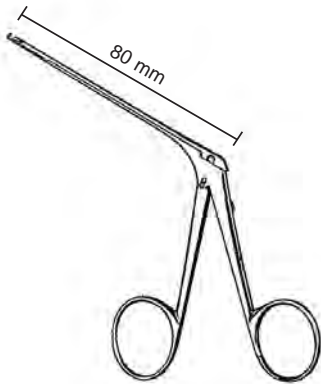

DIETER  
 45385-01 - 45387-02

micro ø 1,3 mm



45385-01

aufwärts  
 upward  
 arriba  
 in alto

mini ø 1,8 mm

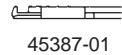

45387-01



45385-02

abwärts  
 downward  
 abajo  
 in basso

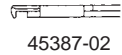

45387-02

Micro-Ohrzängchen  
 Micro Ear Forceps  
 Pinzas auriculares micro  
 Pinze auricolari micro



45390-35  
 0,8 x 3,5 mm

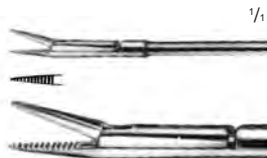

45390-50  
 1 x 5 mm

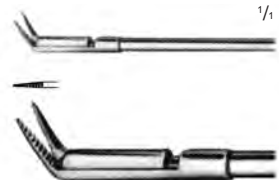

45391-35  
 0,8 x 3,5 mm



45392-35  
 0,8 x 3,5 mm



45393-50  
 1 x 5 mm



45394-50  
 1 x 5 mm

Micro-Ohrzängchen  
 Micro Ear Forceps  
 Pinzas auriculares micro  
 Pinze auricolari micro



WULLSTEIN



45400-01  
 0,9 x 1 mm



45400-02  
 0,8 x 1,3 mm



45400-03  
 1 mm



45401-25  
 1,7 x 2,5 mm

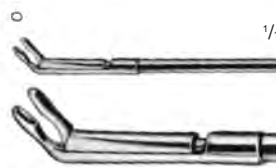

45402-10  
 0,9 x 1 mm



45403-13  
 0,8 x 1,3 mm



45404-13  
 0,8 x 1,3 mm

Micro-Ohrscheren  
Micro Ear Scissors  
Tijeras auriculares micro  
Forbici auricolari micro



BELLUCCI



45410-01



45411-01



45412-01



45413-01



45414-01

Messer  
Knives  
Cuchillos  
Coltelli



SCHUKNECHT  
45701-01  
16 cm, 6 1/4"



SCHUKNECHT  
45701-02  
16 cm, 6 1/4"



SCHUKNECHT  
45703-15  
15,5 cm, 6"



WULLSTEIN  
45704-15  
15,5 cm, 6"



TABB  
45705-15  
15,5 cm, 6"

3,5 mm Ø



PLESTER  
45706-35  
15,5 cm, 6"



45709-10  
1,0 mm



45709-14  
1,4 mm



45709-16  
1,6 mm



45709-20  
2,0 mm



45709-26  
2,6 mm



45709-28  
2,8 mm



45709-30  
3,0 mm



ROSEN  
45709-10 - 45709-30  
16 cm, 6 1/4"

Nadeln und Hackchen  
 Needles and Hooks  
 Aguja y Ganchos  
 Aghi e uncini



16 cm  
 6 1/4"

BARBARA  
 45710-15



BARBARA  
 45711-15



BARBARA  
 45713-15



BARBARA  
 45715-17



25°  
 SHAMBAUGH  
 mm 0,3 45720-03  
 0,6 45720-06  
 1,0 45720-10



45°  
 SHAMBAUGH  
 mm 0,3 45722-03  
 0,6 45722-06  
 1,0 45722-10  
 1,2 45722-12  
 1,5 45722-15  
 2,0 45722-20  
 2,5 45722-25



90°  
 SHAMBAUGH  
 mm 0,3 45724-03  
 0,6 45724-06  
 1,0 45724-10  
 1,2 45724-12  
 1,5 45724-15  
 2,0 45724-20  
 2,5 45724-25



BARBARA  
 45725-05=0,5 mm  
 45725-10=1,0 mm



45730-03 - 45747-10  
 15,5 cm, 6"



mm 90° 90°  
 0,3 45730-03 45732-03  
 0,6 45730-06 45732-06  
 1,0 45730-10 45732-10



mm McGEE McGEE  
 0,5 45733-05 45735-05  
 1,0 45733-10 45735-10



BARBARA  
 45736-15  
 15,5 cm, 6"



ROSEN  
 mm 25° 25° 45° 45°  
 0,3 45741-03 45743-03 45745-03 45747-03  
 0,6 45741-06 45743-06 45745-06 45747-06  
 1,0 45741-10 45743-10 45745-10 45747-10





Dissektoren, Küretten, Elevatoren, Mikro-Meßsonde  
 Dissectors, Curettes, Elevators, Micro measuring rod  
 Disectores, Curetas, Elevadores, Sonda para medir  
 Dissettori, Curette, Elevatori, Sonda auricolare per misurare

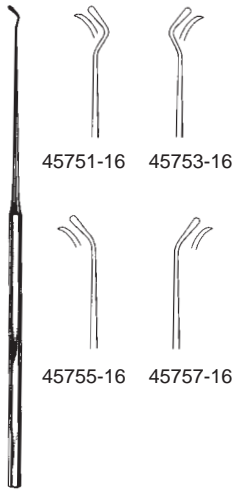

45751-16 45753-16

45755-16 45757-16

FISCH  
 45751-16 - 45757-16  
 16 cm, 6 1/4"

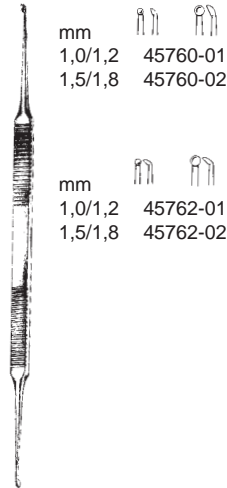

mm  
 1,0/1,2 45760-01  
 1,5/1,8 45760-02

mm  
 1,0/1,2 45762-01  
 1,5/1,8 45762-02

HOUSE  
 45760-01 - 45762-02  
 15 cm, 6"



45802-16  
 2 mm

45803-16  
 2 mm

45805-16  
 3 mm

LEMPERT  
 45802-16 - 45805-16  
 16 cm, 6 1/4"

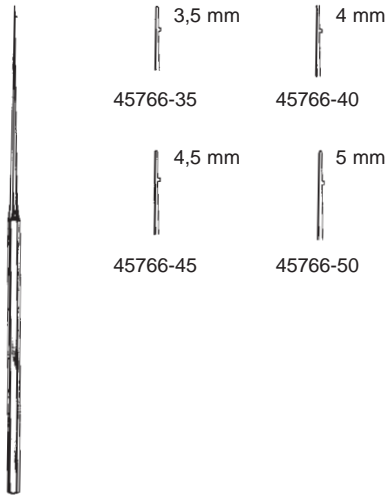

3,5 mm 4 mm

45766-35 45766-40

4,5 mm 5 mm

45766-45 45766-50

HOUSE  
 45766-35 - 45766-50  
 16 cm, 6 1/4"



LEMPERT  
 45807-20  
 20,5 cm, 8"

Nasenspekula  
 Nasal Specula  
 Espéculos nasales  
 Specoli nasali



THUDICHUM  
 47050-01 - 47050-07

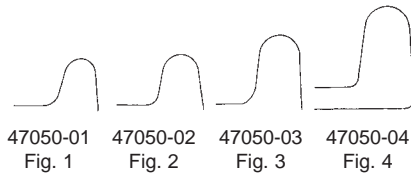

47050-01 Fig. 1    47050-02 Fig. 2    47050-03 Fig. 3    47050-04 Fig. 4

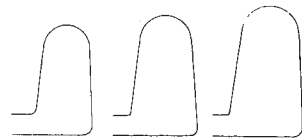

47050-05 Fig. 5    47050-06 Fig. 6    47050-07 Fig. 7

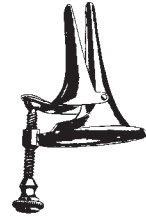

VOLTOLINI  
 47060-01 - 47060-03

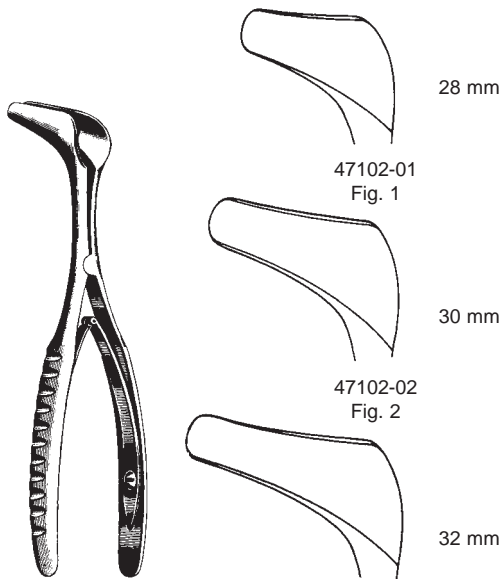

HARTMANN-HALLE  
 47102-01 - 47102-03  
 15 cm, 6"

47102-03  
 Fig. 3

Baby, bebé  
 Kind, child, niño, bamb.  
 Erwachs., Adult, adulto

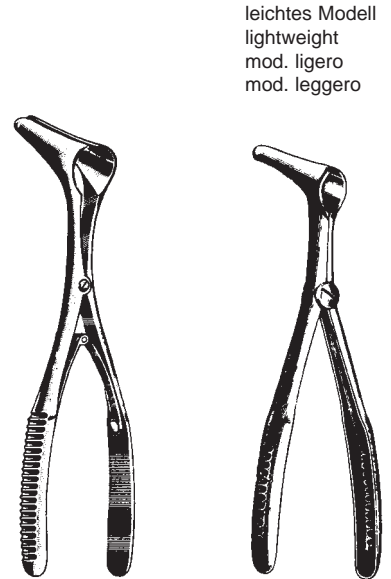

Mod. VIENNA  
 47112-01 25 mm  
 47112-02 30 mm  
 47112-03 35 mm

Mod. VIENNA  
 47113-03

leichtes Modell  
 lightweight  
 mod. ligero  
 mod. leggero

Nasenspekula  
Nasal Specula  
Espéculos nasales  
Specoli nasali



1/4

Nasenspekula, Kehlkopfspiegel  
 Nasal Specula, Laryngeal Mirrors  
 Espéculos nasales, espejos laríngeos  
 Specoli nasali, Specchi laringei

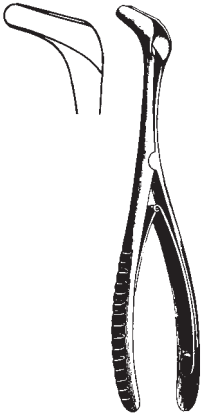

TIECK-HALLE  
 47116-13  
 13,5 cm, 5 1/4"



REDA  
 47118-13  
 12,5 cm, 5"



KILLIAN  
 47120-35 - 47120-90  
 13 cm, 5 1/8"



47120-35  
 35 mm

47120-50  
 50 mm

47120-75  
 75 mm

47120-90  
 90 mm



COTTLE  
 47124-35 - 47124-90  
 14 cm, 5 1/2"

47124-35 35 mm  
 47124-50 50 mm  
 47124-75 75 mm  
 47124-90 90 mm

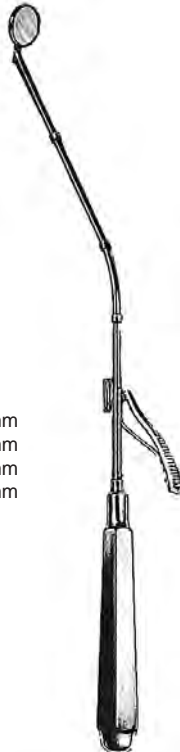

MICHEL  
 47139-12 - 47139-18  
 25 cm, 10"



47139-12  
 12 mm



47139-14  
 14 mm



47139-16  
 16 mm



47139-18  
 18 mm

Nasenpinzetten, Polypenzange  
 Ear Dressing Forceps, Ear Polypus Forceps  
 Pinzas auriculares, Pinzas para pólipos  
 Pinze auricolari, Pinze per polipi



TROELTSCH  
 47151-15  
 15 cm, 6"

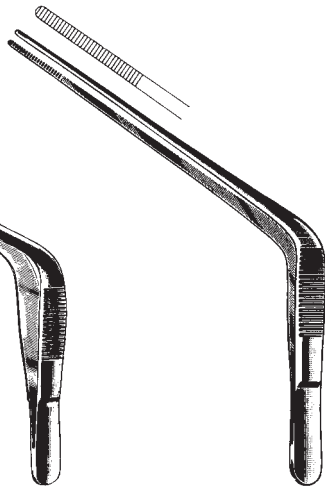

TROELTSCH  
 47151-18  
 18 cm, 7"



JANSEN-GRUENWALD  
 47154-20  
 20 cm, 8"



JANSEN  
 47155-20  
 20 cm, 8"

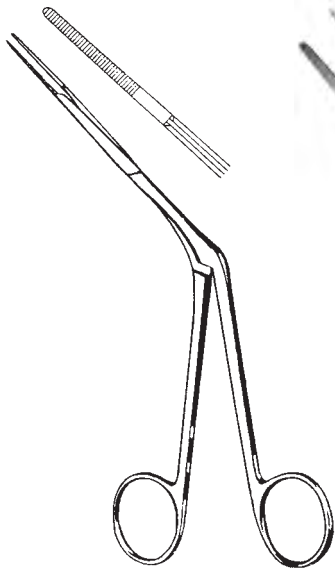

WESTMACOTT  
 47158-20  
 20 cm, 8"



LUBET-BARBON  
 47159-20  
 20 cm, 8"

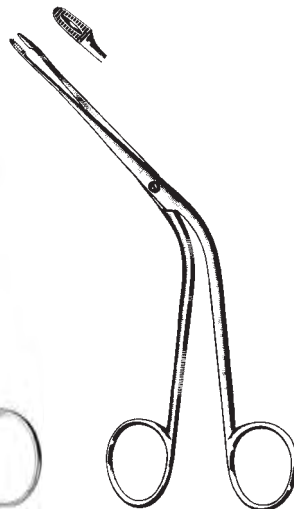

HARTMANN  
 47161-16  
 16 cm, 6 1/4"

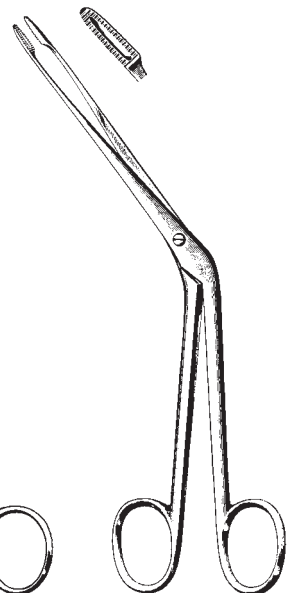

HARTMANN  
 47161-20  
 20 cm, 8"

Polypenzangen, Septumzangen  
 Nasal Polypus and Septum Forceps  
 Pinzas para pólipos y para el tabique nasal  
 Pinze per polipi, Pinze per il setto nasale

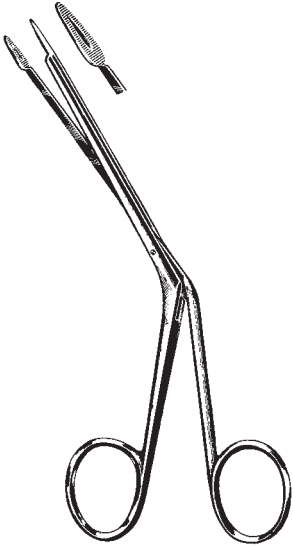

LITTAUER  
 47167-18  
 18 cm, 7"

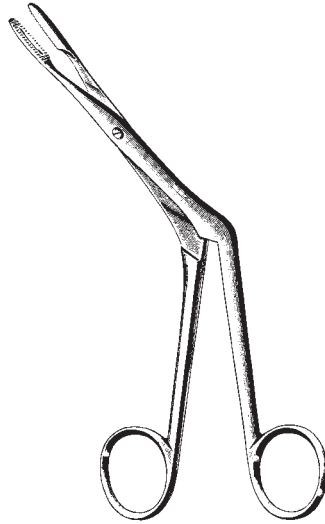

HEYMANN-KNIGHT  
 47169-18  
 18 cm, 7"

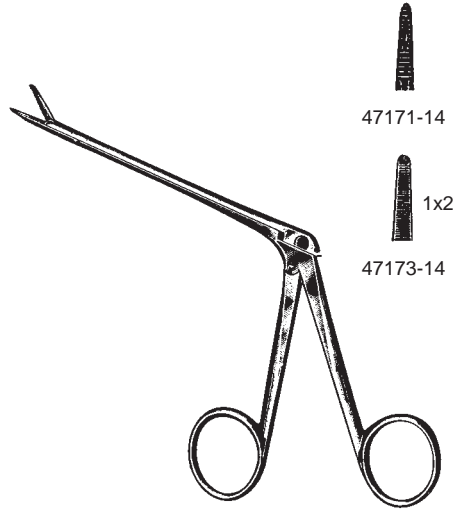

NOYES  
 47171-14 - 47173-14  
 14,5 cm, 5 3/4"

47171-14  
 1x2  
 47173-14

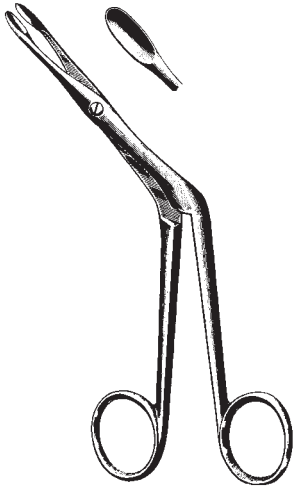

HEYMANN  
 47181-18  
 18 cm, 7"

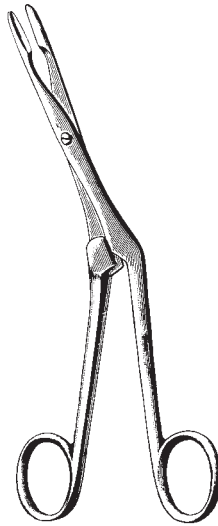

KNIGHT  
 47185-18  
 18 cm, 7"

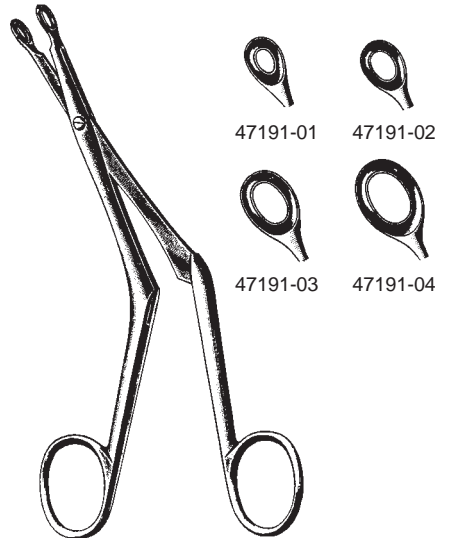

BRUENINGS  
 47191-01 - 47191-04  
 19 cm, 7 1/2"

47191-01    47191-02  
 47191-03    47191-04

Scharfe Nasenzangen, Septumzangen  
 Nasal Cutting Forceps, Septum Forceps  
 Pinzas cortantes nasales y para el tabique nasal  
 Pinze taglianti nasali, Pinze per il setto nasale



GRAIG  
 47192-16  
 16 cm, 6 1/4"

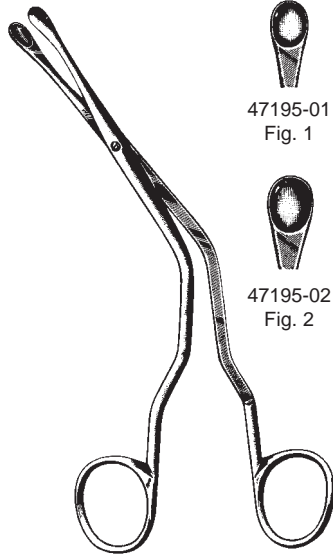

LUC  
 47195-01 - 47195-05  
 19 cm, 7 1/2"

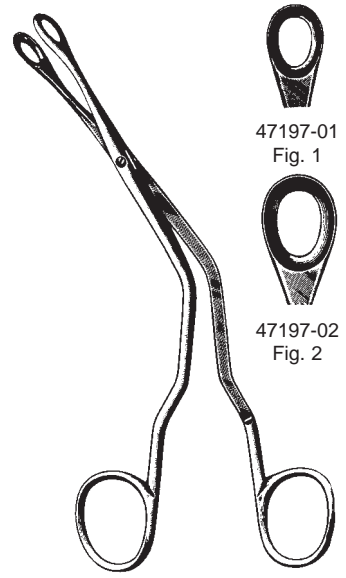

LUC  
 47197-01 - 47197-02  
 19 cm, 7 1/2"

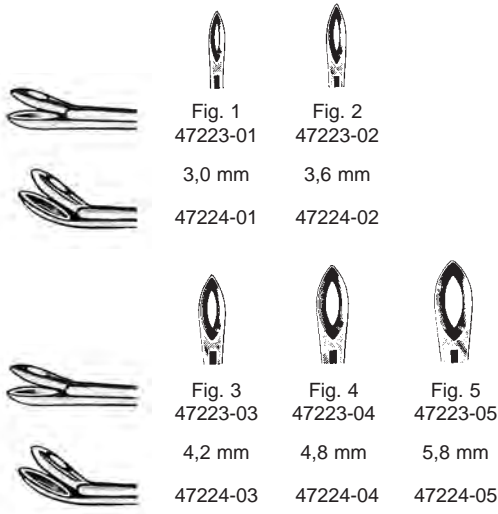

WEIL-BLAKESLEY  
 47223-01 - 47224-05

Scharfe Nasenzangen  
 Nasal Cutting Forceps  
 Pinzas cortantes nasales  
 Pinze taglianti nasali

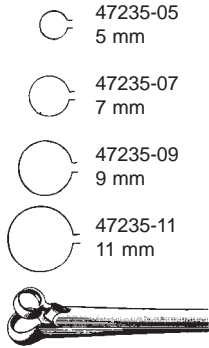

HARTMANN

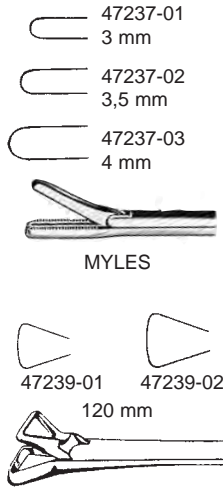

MYLES

SCHMEDEN

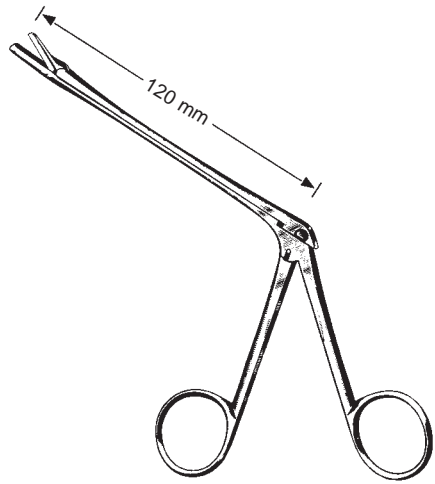

STRUYCKEN  
 47240-19

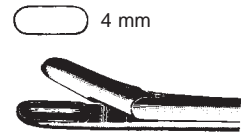

47242-00

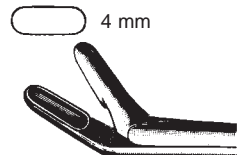

47242-01

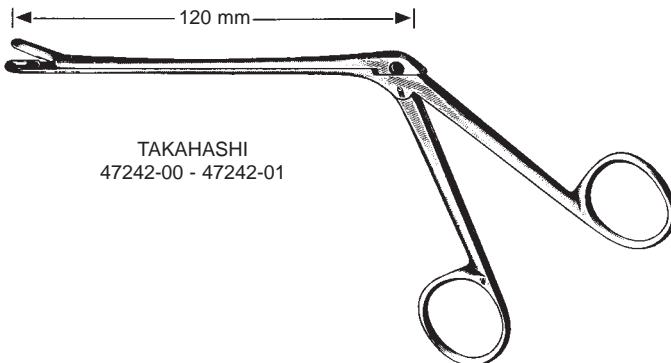

TAKAHASHI  
 47242-00 - 47242-01



Scharfe Nasenzangen, Septumzange, Kieferhöhlenstanze  
 Nasal Cutting Forceps, Septum Forceps, Antrum Punch Forceps  
 Pinzas cortantes nasales, Pinza para magullar tabique, Pinzas cortantes para maxilares  
 Pinze taglianti nasali, Pinza per ammaccare il setto, Pinze taglianti per seno mascellare

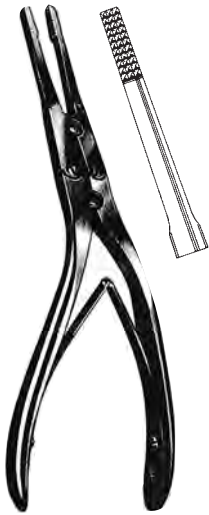

RUBIN  
 47251-21  
 21 cm, 8 1/4"

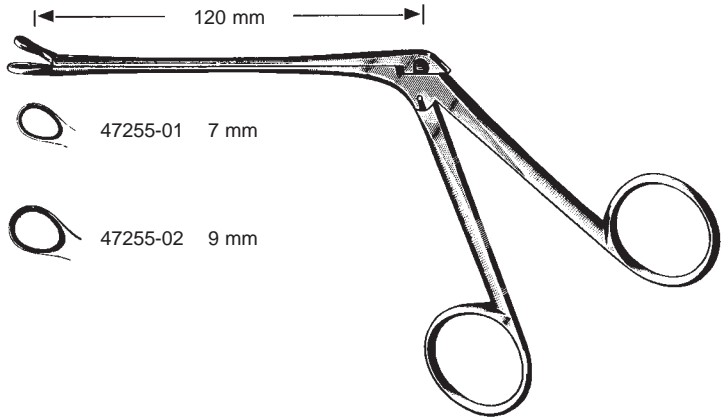

WATSON-WILLIAMS  
 47255-01

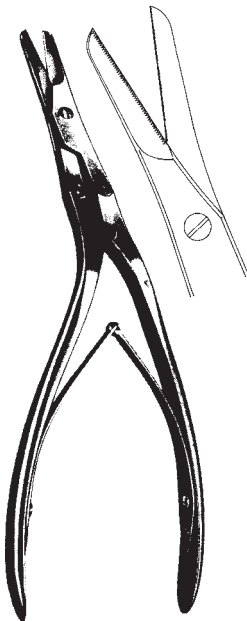

CAPLAN  
 47256-20  
 20 cm, 8"



KERRISON  
 3x3 mm 47303-03  
 4x4 mm 47303-04  
 5x5 mm 47303-05  
 6x6 mm 47303-06  
 17 cm, 6 3/4"

Kieferhöhlenstanze, Nasenschere  
 Antrum Punch Forceps, nasal scissors  
 Pinzas cortantes para maxilares, tijera nasal  
 Pinze sfenoidali, forbici nasali



47304-01 5x3,5 mm

47304-03 5x4 mm



47304-02 5x3,5 mm

47304-04 5x4 mm



HAJEK-KOFLER  
 47304-01 - 47304-04

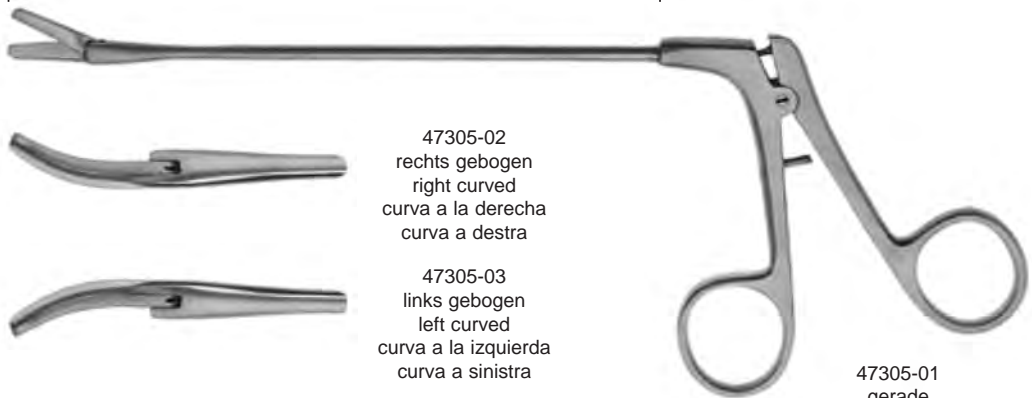

47305-02  
 rechts gebogen  
 right curved  
 curva a la derecha  
 curva a destra

47305-03  
 links gebogen  
 left curved  
 curva a la izquierda  
 curva a sinistra

47305-01  
 gerade  
 straight  
 recta  
 retta

Knochenstanze, Septumzangen  
 Punches, Septum Forceps  
 Pinzas osteótomas, Pinzas para el tabique nasal  
 Pinze osteotomi, Pinze per il setto nasale

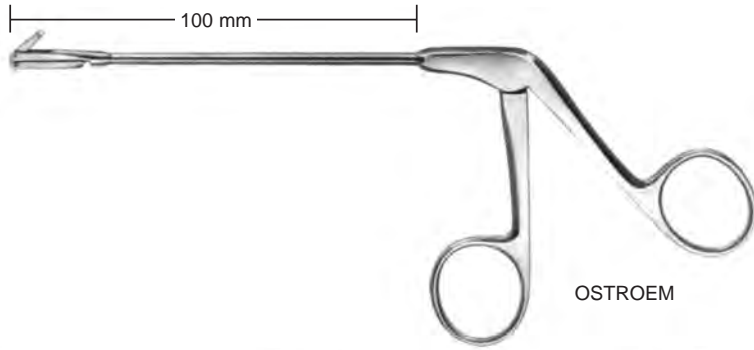

OSTROEM



47315-00  
 2 mm  
 oben schneidend  
 up cutting  
 cortante por arriba  
 tagliente in alto



47316-00  
 2 mm  
 rechts schneidend  
 right cutting  
 cortante a la derecha  
 tagliente a destra



47317-00  
 2 mm  
 links schneidend  
 left cutting  
 cortante a la izquierda  
 tagliente a sinistra



CITELLI  
 47311-10 1,0 mm  
 47311-25 2,5 mm  
 47311-30 3,0 mm

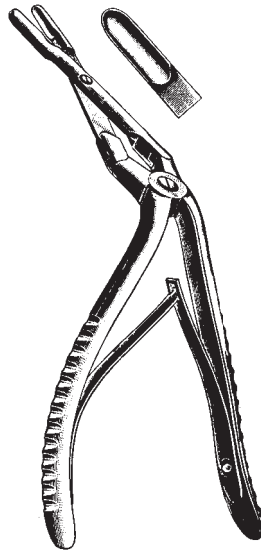

MIDDLETON-JANSEN  
 47323-19  
 19 cm, 7 1/2"

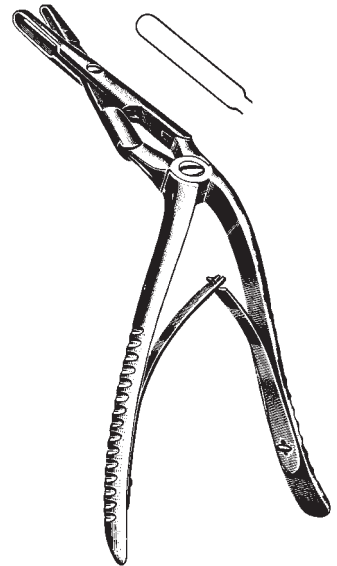

MIDDLETON-JANSEN  
 47325-19  
 19 cm, 7 1/2"

Kieferhöhlenstanze, Sinuskopie-Zangen  
 Antrum Punch Forceps, Sinuscopy forceps  
 Pinzas cortantes para maxilares, Pinzas para senoscopia  
 Pinze sfenoidali per seno mascellare, Pinze per sinuscopia



HAJEK-KOFLER  
 47316-16  
 3,5 mm

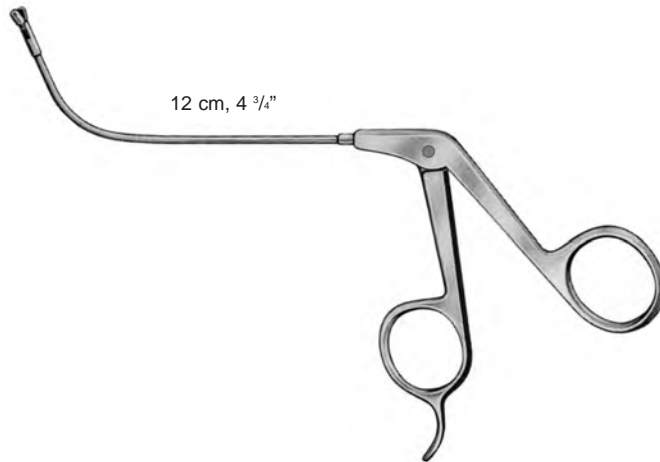

Maul  
 jaw  
 boca  
 morso

horizontal öffnend  
 horizontal cutting  
 abierta horizontal  
 apertura orizzontale

vertikal öffnend  
 vertical cutting  
 abierta vertical  
 apertura verticale

65° ○ 3 mm rund  
 70° ○ } oval  
 90° ○ }  
 110° ○ }

47317-65  
 47317-70  
 47317-90  
 47317-11

47318-65  
 47318-70  
 47318-90  
 47318-11

Zirkular Stanze  
Circular Forceps  
Pinza circular  
Pinza circolare



47319-35 3,5 mm  
47319-45 4,5 mm

Spülkanülen, Punktionskanüle, Stirnhöhlendilatator  
 cannulas, Antrum trocar needle, Frontal sinus bougies  
 cánulas, cánula de punción, Dilatador para el seno  
 cannulas, cannula per punzione, Dilatatore per seno frontale

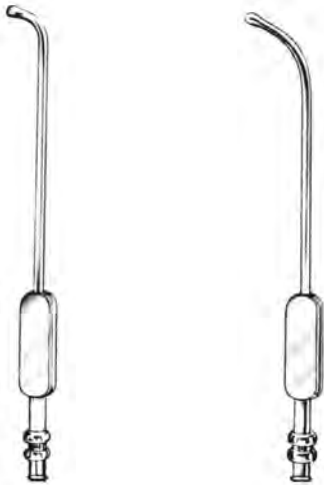

EICKEN (KILLIAN)

14,5 cm, 5 3/4"

Ø

47331-20	2,0 mm	47332-20
47331-25	2,5 mm	47332-25
47331-30	3,0 mm	47332-30
47331-40	4,0 mm	47332-40



HARTMANN

Fig. 1

Ø

Fig. 2

47338-20	2,0 mm	47339-20
47338-25	2,5 mm	47339-25
47338-30	3,0 mm	47339-30



Ø mm LICHTWITZ

1,5	47340-15
1,8	47340-18
2,0	47340-20

Luer-Lock  
 10 cm, 4"



Ø mm RITTER-HALLE

2,5	47342-25
3,0	47342-30
4,0	47342-40

Kiefer- und Stirnhöhlen-Spülkanülen, Saugraspatorium  
 Antrum and Frontal Sinus Wash Cannulas, Suction Raspatory  
 Cánulas lavadoras para seno maxilar y seno frontal, Legra de succión  
 Cannule per seno mascellare e seno frontale, Raspatorio con aspiratore

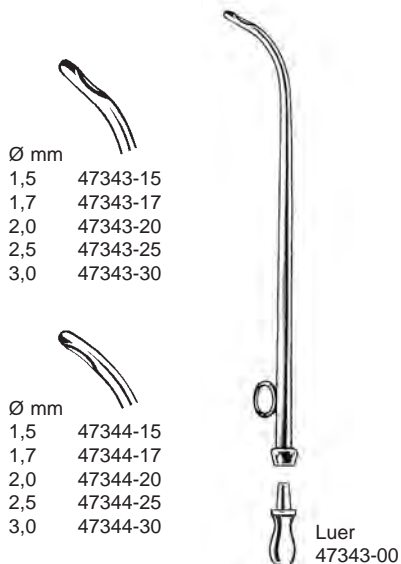

SIEBENMANN  
 47343-15 - 47344-30



KILLIAN  
 Ø 1,5 mm  
 47345-15



GUILLEN  
 19 cm, 7 1/2"  
 47347-20

Polypenschnürer  
Ear Polypus Snares  
Polipótomos  
Serranodi



KRAUSE-VOSS  
47350-26  
26 cm, 10 1/4"



KRAUSE  
47351-26  
26 cm, 10 1/4"

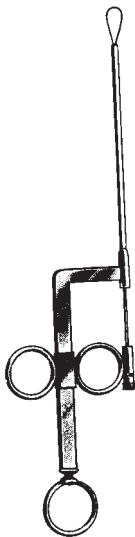

WILDE  
47352-24  
24 cm, 9 1/2"



47355-03 0,3 mm



Nasenmesser  
 Nasal Knives  
 Bisturies nasales  
 Coltelli nasali

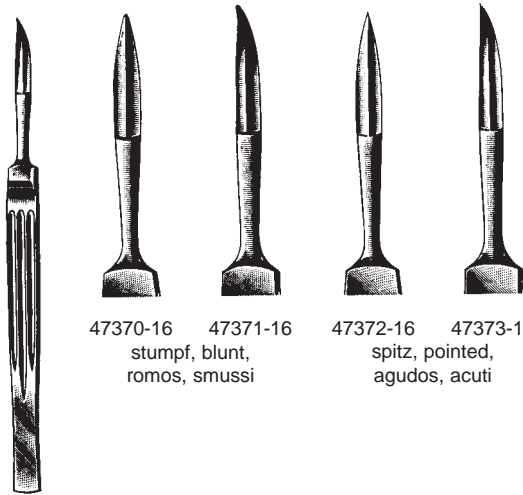

47370-16 47371-16  
 stumpf, blunt,  
 romos, smussi

47372-16 47373-16  
 spitz, pointed,  
 agudos, acuti

JOSEPH  
 47370-16 - 47373-16  
 16 cm, 6 1/4"



FREER  
 47374-16  
 16,5 cm, 8 1/4"



FREER  
 47375-19  
 19 cm, 7 1/2"



JOSEPH  
 47375-16  
 16,5 cm, 6 1/2"

Nasenplastik- und Operationsmesser, Sichelmesser, Küretten  
 Rhinoplastic and Nasal Knives, Septum Sickle Knives, Curettes  
 Bisturías para plástica y operaciones de la nariz, Bisturías para el tabique nasal, Curetas  
 Bisturi per la plástica ed operazioni nasali, coltelli per setto, Curette

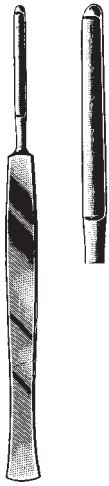

JOSEPH  
 47376-16  
 16 cm, 6 1/4"

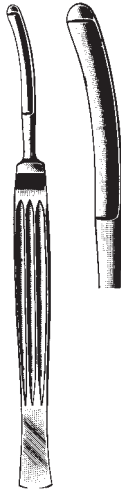

CONVERSE  
 47379-16  
 16 cm, 6 1/4"



COTTLE  
 47380-15  
 15 cm, 6"



COTTLE  
 47382-15  
 15 cm, 6"



JOSEPH  
 47384-15  
 15 cm, 6"



JOSEPH  
 47385-15  
 15 cm, 6"



REDA  
 19 cm, 7 1/2"



47386-01  
 spitz  
 pointed  
 agudo  
 acuto



47386-02  
 stumpf  
 blunt  
 romo  
 smusso



47387-01  
 vorwärts schneidend  
 forward cutting  
 corte hacia adelante  
 taglio in avanti



47387-02  
 rückwärts schneidend  
 backward cutting  
 corte hacia atras  
 taglio retrograde



ANTRUM  
 19 cm, 7 1/2"

Schwingmesser  
Septum Swivel Knives  
Bisturies para el tabique nasal  
Coltelli per setto



47390-03  
3 mm



47390-04  
4 mm



47390-05  
5 mm



47392-03  
3 mm



47392-04  
4 mm



47392-05  
5 mm

BALLENGER  
47390-03 - 47392-05  
20 cm, 8"

Septum Elevatoren  
 Septum Elevators  
 Elevadores para el tabique  
 Elevatori per setto



McKENTY  
 47410-04 - 47410-05  
 15 cm, 6"



47410-04  
 4 mm

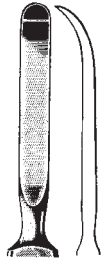

47410-05  
 5 mm



HALLE  
 47410-16  
 16.5 cm, 6 1/2"



JOSEPH  
 47411-16  
 16 cm, 6 1/4"

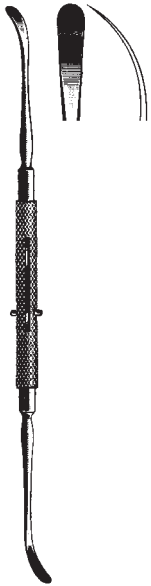

ROGER  
 47413-19  
 19 cm, 7 1/2"

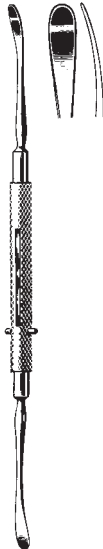

FREER  
 47415-18  
 18 cm, 7"



FREER  
 47417-19  
 19 cm, 7 1/2"

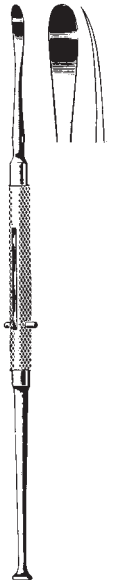

FREER  
 47419-19  
 19 cm, 7 1/2"

Septum Elevatoren  
 Septum Elevators  
 Elevadores para el tabique  
 Elevatori per setto



KILLIAN  
 47420-01  
 18,5 cm, 7 1/4"



PIERCE  
 47420-02  
 21 cm, 8 1/4"



SINUS  
 47420-03  
 18 cm, 7"



PENNINGTON  
 47420-04  
 21 cm, 8 1/4"



McKENTY  
 47420-20  
 22 cm, 8 3/4"



HOWARTH  
 47421-21  
 21,5 cm, 8 1/2"

Septum Elevatoren  
 Septum Elevators  
 Elevadores para el tabique  
 Elevatori per setto

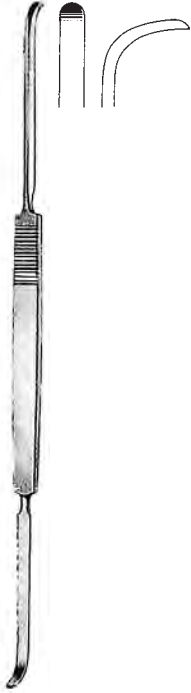

COTTLE  
 47421-23  
 23 cm, 9"



COTTLE JOSEPH  
 47422-22  
 22 cm, 8 3/4"



COTTLE  
 47423-22  
 22 cm, 8 3/4"

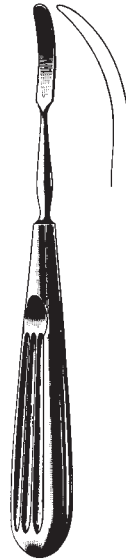

COTTLE  
 47424-16  
 16 cm, 6 1/4"



COTTLE  
 47425-19  
 19 cm, 7 1/2"



KILLIAN  
 47426-22  
 22 cm, 8 3/4"



HAJEK-BALLENGER  
 47428-21  
 22 cm, 8 3/4"



BALLENGER  
 47430-22  
 22 cm, 8 3/4"



FREER  
 47450-04  
 15 cm, 6"



FREER  
 47451-04  
 15 cm, 6"

Septum Meißel, Knorpelquetscher  
 Rhinoplastic Chisels, Cartilage crusher  
 Cinceles para la plástica nasal, Macha cadera  
 Scalpelli per plastica nasale, Tritacartilagine

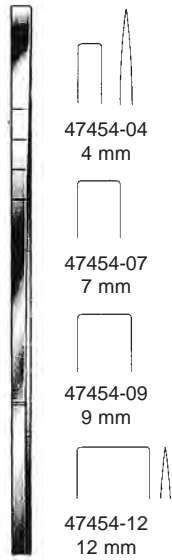

47454-04  
4 mm

47454-07  
7 mm

47454-09  
9 mm

47454-12  
12 mm

COTTLE  
 47454-04 - 47454-12  
 18 cm, 7"



6 mm

COTTLE  
 47455-06  
 18 cm, 7"

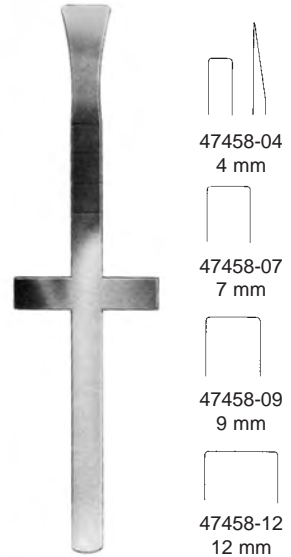

47458-04  
4 mm

47458-07  
7 mm

47458-09  
9 mm

47458-12  
12 mm

COTTLE  
 47458-04 - 47458-12  
 18 cm, 7"

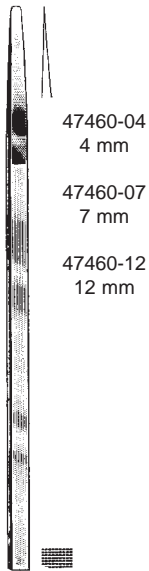

47460-04  
4 mm

47460-07  
7 mm

47460-12  
12 mm

COTTLE  
 47460-04 - 47460-12  
 18 cm, 7"



COTTLE  
 Knorpelquetscher  
 47461-00

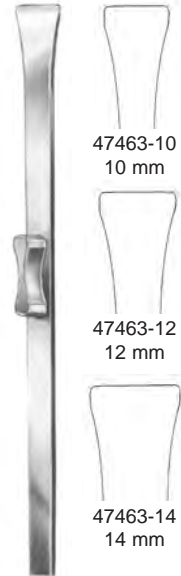

47463-10  
10 mm

47463-12  
12 mm

47463-14  
14 mm

RUBIN  
 18,5 cm, 7 1/4"

Septum Meißel  
 Rhinoplastic Chisels  
 Cinceles para la plàstica nasal  
 Scalpelli per plastica nasale

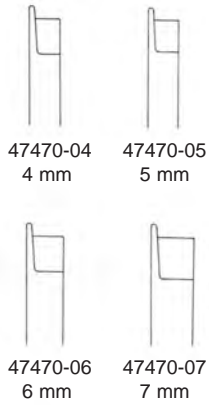

FOMON  
 47470-04 - 47470-07  
 17 cm, 6 3/4"

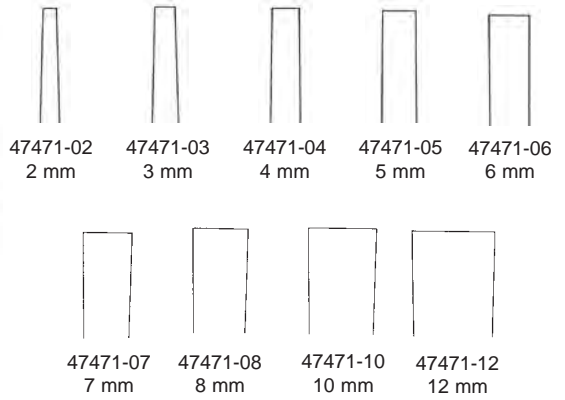

SHEEHAN  
 47471-07 - 47471-12  
 16 cm, 6 3/4"

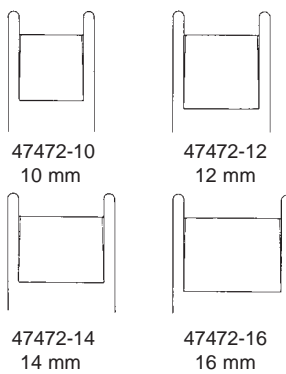

CINELLI  
 47472-10 - 47472-16  
 16 cm, 6 1/4"



Osteotom, Septum Meißel  
 Osteotomes, Rhinoplastic Chisels  
 Osteotomi, Cinceles para la plástica nasal  
 Osteotomi, Scalpelli per plastica nasale

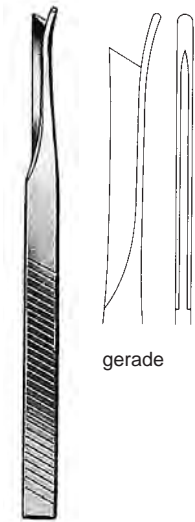

gerade

SILVER  
 47473-01  
 18 cm, 7"

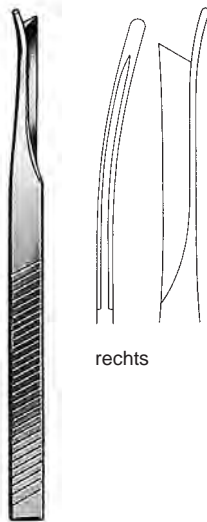

rechts

SILVER  
 47473-02  
 18 cm, 7"

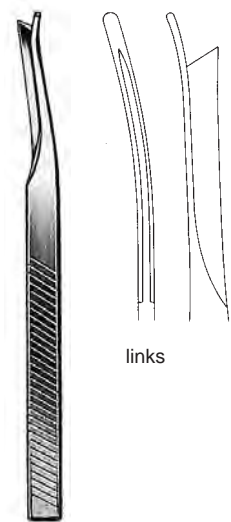

links

SILVER  
 47473-03  
 18 cm, 7"



47474-01  
 7 mm

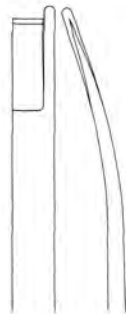

47474-02  
 7 mm

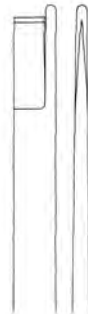

47474-03  
 7 mm

NEIVERT-ANDERSON  
 47474-01 - 47474-03  
 20,5 cm, 8"

Septum Meißel  
 Rhinoplastic Chisels  
 Cinceles para la plástica nasal  
 Scalpelli per plastica nasale



KILLIAN  
 47481-05  
 16 cm, 6 1/4"

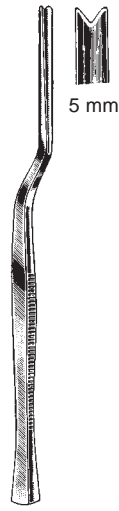

KILLIAN-CLAUS  
 47482-05  
 17 cm, 6 3/4"



mm	HAJEK
4	47484-04
6	47484-06
8	47484-08
	16 cm, 6 1/4"



WEST  
 47486-16  
 16 cm, 6 1/4"



WEST  
 47487-16  
 16 cm, 6 1/4"

6 mm



FREER  
 47489-16  
 16 cm, 6 1/4"



Nasenraspeln  
 Nasal Rasps  
 Escofinas nasales  
 Raspa nasale

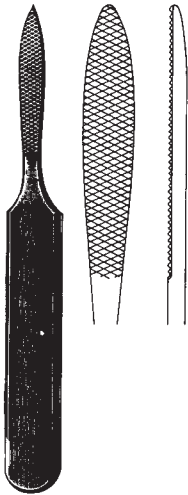

JOSEPH  
 47502-16  
 16 cm, 6 1/4"

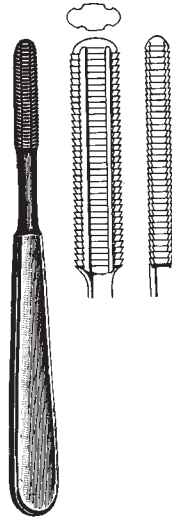

MALTZ  
 47504-18  
 18 cm, 7"



WIENER  
 47507-17 - 47507-19  
 18 cm, 7"

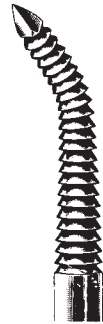

47507-17



47507-19



AUFRICHT  
 47511-21 - 47513-21  
 21 cm, 8 1/4"

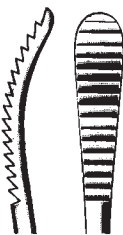

47511-21

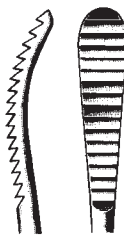

47513-21



JOSEPH (LEWIS)  
 47514-16 - 47516-16  
 18 cm, 7"



47514-16  
 fein, fino  
 fine, fina

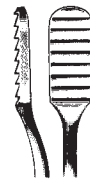

47516-16  
 grob, coarse,  
 gruesa, grossa

Nasenraspeln  
 Nasal Rasps  
 Escofinas nasales  
 Raspa nasale

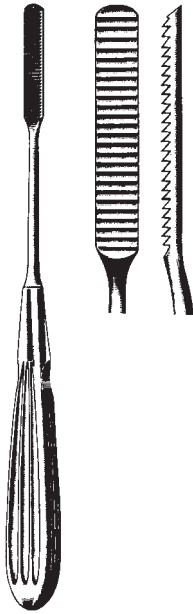

MALTZ (COTTLE)  
 47518-21  
 21 cm, 8 1/4"

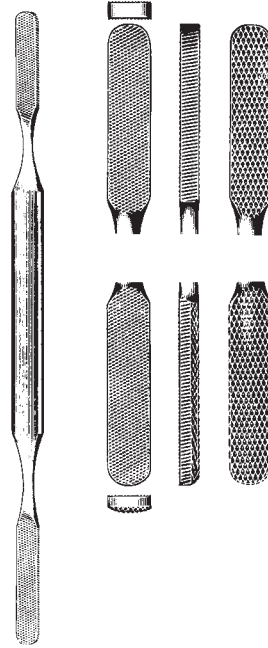

FOMON  
 47520-21  
 21 cm, 8 1/4"



MILLER  
 18 cm, 7"



47521-01

5 mm



47521-02

4,3 mm

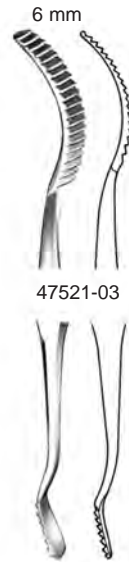

47521-03

5 mm

Nasenraspeln  
Nasal Rasps  
Escofinas nasales  
Raspa nasale



1



2



3



4



5

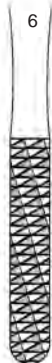

6



7



8



9



10

FOMON

47522-01 - 47522-09 TC  
20 cm, 8"

Fig. 1/2

47522-01 TC

Fig. 3/4

47522-04 TC

Fig. 5/6

47522-05 TC

Fig. 7/8

47522-07 TC

Fig. 9/10

47522-09 TC

Nasenraspeln, Nasensägen  
 Nasal Rasps, Nasal Saws  
 Escofinas nasales, Sierras nasales  
 Raspa nasale, Seghe nasale



PEET  
 47523-01 —  
 47523-02 —  
 19 cm, 7 1/2"



GALLAHER  
 47526-16 - 47529-16  
 16 cm, 6 1/4"



Fig. 1  
 47526-16



Fig. 2  
 47527-16

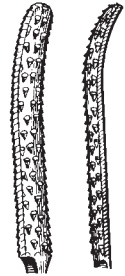

Fig. 3  
 47529-16



JOSEPH  
 47535-01 47535-02  
 17 cm, 6 3/4"



links  
 left  
 izquierda  
 a sinistra

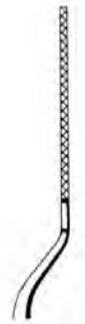

rechts  
 right  
 derecha  
 a destra

gerade  
 straight  
 redo  
 retta



JOSEPH  
 47532-19 19 cm (7 1/2") 47534-19  
 47533-19

Nasenhaken  
Nasal retractor  
Retradores nasales  
Retrattori nasali



COTTLE  
47540-16  
16 cm, 6 1/4"



MASING  
47541-14  
14 cm, 5 1/2"



AUFRICHT  
47542-12  
12 cm, 4 3/4"



AUFRICHT  
47551-16  
16 cm, 6 1/4"



AUFRICHT  
47551-16L  
16 cm, 6 1/4"



MASING-NEIVERT  
47552-16  
16 cm, 6 1/4"



Nasenhaken, Hauthäkchen  
 Nasal retractor  
 Retractores nasales, Ganchos para la piel  
 Retrattori nasali, uncini nasali

10 x 12 mm



COTTLE  
 47553-15  
 15 cm, 6"



47554-01



47554-02

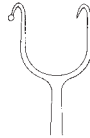

47554-03

COTTLE  
 14,5 cm, 5 3/4"

3 x 11 mm



KILNER  
 47555-08  
 8 cm, 3 1/8"

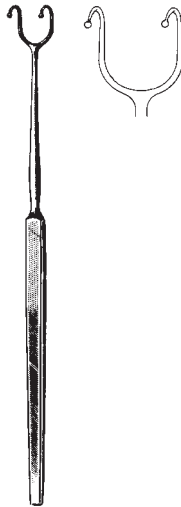

FOMON  
 47556-16  
 16 cm, 6 1/4"



FOMON  
 47557-17  
 17 cm, 6 3/4"



Hauthäkchen, Columella Pinzette  
 Retractor, Columnella forceps  
 Ganchos para la piel, Pinza para columnela  
 Uncini, Pinzetta columella



FREER  
 47558-15  
 15 cm, 6"



COTTLE-NEIVERT  
 47559-20  
 20 cm, 8"



Fig. 1 GILLIES  
 47560-18  
 Fig. 2 47562-18  
 18 cm, 7"



Fig. 1



Fig. 2



LANGE  
 47563-22  
 23 cm, 9"



COTTLE  
 47564-16  
 16 cm, 6 1/4"



COTTLE  
 47565-10  
 10 cm, 4"



CONVERSE  
 47566-12  
 12 cm, 4 3/4"

Septumrichtzangen, Küretten  
 Septum Straightening Forceps, Curettes  
 Pinza para enderezar el tabique nasal, curetas  
 Pinza per la plastica nasale, Curette



ASCH  
 47571-23  
 23 cm, 9"



WALSHAM  
 47572-23 - 47575-23  
 23 cm, 9"

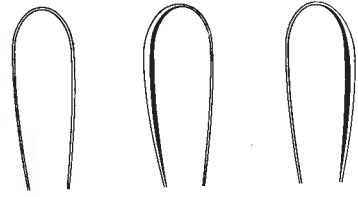

47572-23  
 gerade  
 straight  
 recta  
 retta

47573-23  
 links  
 left  
 izquierda  
 a sinistra

47575-23  
 rechts  
 right  
 derecha  
 a destra

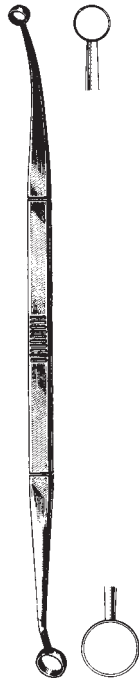

FAULKNER  
 47601-21  
 21 cm, 8 1/4"



COAKLEY  
 47607-01 - 47607-06  
 17 cm, 6 3/4"



47607-01  
 Fig. 1



47607-02  
 Fig. 2



47607-03  
 Fig. 3



47607-04  
 Fig. 4



47607-05  
 Fig. 5



47607-06  
 Fig. 6

Ringmesser, Innendurchmesser  
 Adenoid Curettes, inner diameter  
 Cuchillos para vegetaciones adenoides, camera diámetro  
 Coltelli per vegetazioni adenoide, interno diametro

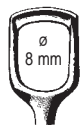

47620-00  
Fig. 0

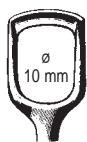

47620-01  
Fig. 1

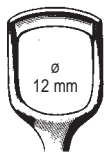

47620-02  
Fig. 2



47620-03  
Fig. 3

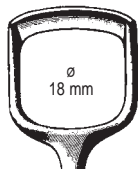

47620-04  
Fig. 4

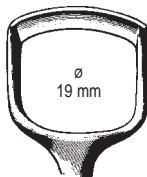

47620-05  
Fig. 5

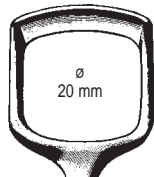

47620-06  
Fig. 6

BECKMANN  
47620-01 - 47620-06  
22 cm, 8 3/4"



47636-01  
Fig. 1



47636-02  
Fig. 2



47636-03  
Fig. 3



47636-04  
Fig. 4

St. CLAIR-THOMSON  
47636-01 - 47636-04  
21 cm, 8 1/4"



47630-00  
Fig. 0

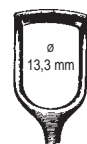

47630-01  
Fig. 1



47630-02  
Fig. 2

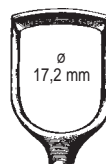

47630-03  
Fig. 3

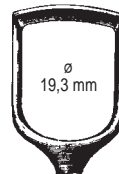

47630-04  
Fig. 4

BARNHILL  
47630-01 - 47630-04  
21 cm, 8 1/4"

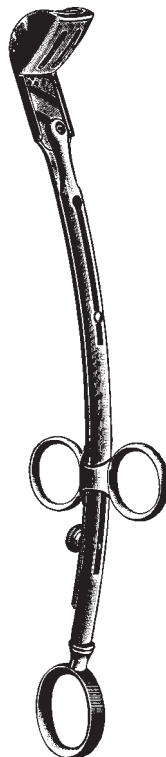

47641-01  
Fig. 1  
ø 12 mm



47641-02  
Fig. 2  
ø 16 mm



47641-03  
Fig. 3  
ø 18 mm

Ersatzklingen allein, gelocht  
 Spare blades, perforated  
 Hojas de repuesto, perforadas  
 Lame di ricambio, forate

Fig. 1 47642-01  
 Fig. 2 47642-02  
 Fig. 3 47642-03

LAFORCE  
47641-01 - 47641-03  
25 cm, 10"

Zungenspatel, Wangen- und Lippenhalter  
 Tongue Depressors, Cheek and Lip Retractors  
 Baja-lenguas, Separadores para labios y mejillas  
 Abbassalingua, Divaricatori per guance e labbra

Holz  
 wood  
 madera  
 legno



49102-16  
 16 cm, 6 1/4"  
 Pack. à 100



MAYO  
 49103-17  
 17 cm, 6 3/4"



KROENIG  
 49104-15  
 15 cm, 6"

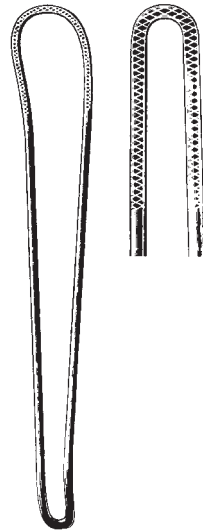

FRENZEL  
 49105-16  
 16,5 cm, 6 1/2"



49106-01  
 14,5 cm, 5 3/4"



49106-02  
 14,5 cm, 5 3/4"



BRUENINGS  
 49107-19  
 19 cm, 7 1/2"



CAWOOD-MINNESOTA  
 49108-15  
 15 cm, 6"

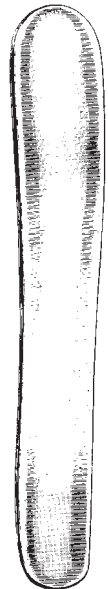

BUCHWALD  
 49109-19  
 19 cm, 7 1/2"

Zungendrucker  
 Tongue Depressors  
 Baja-lenguas  
 Abassalingua



MORITZ-SCHMIDT  
 49110-19  
 19 cm, 7 1/2"

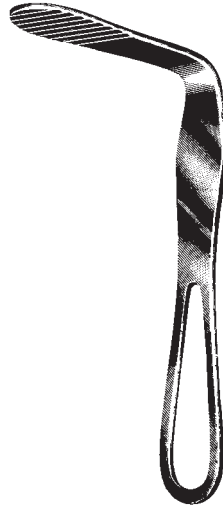

HARTMANN  
 49111-15  
 15 cm, 6"



49115-01  
 Fig. 1  
 14 cm, 5 1/2"



49115-02  
 Fig. 2  
 15 cm, 6"

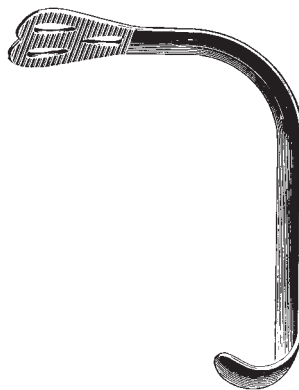

WIEDER  
 49115-01 - 49115-02

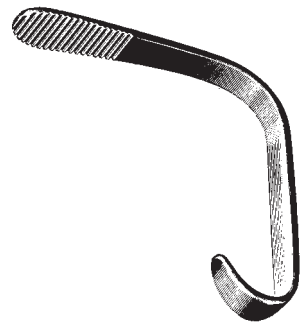

ANDREW  
 49117-11  
 11 cm, 4 3/8"

Zungendrucker, Wangen- und Lippenhalter, Zungenzangen  
 Tongue Depressor, Cheek and Lip Retractor, Tongue Holding Forceps  
 Baja-lenguas, Separadores para labios y mejillas, Pinza tira-lenguas  
 Abassalingua, Divaricatori per guance e labbra, Pinza tiralingua

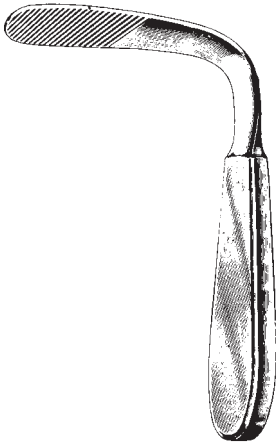

TOBOLD  
 49119-14  
 14,5 cm, 5 <sup>3</sup>/<sub>4</sub>"

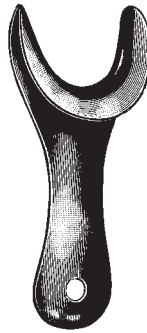

49230-11  
 11 cm, 4 <sup>3</sup>/<sub>8</sub>"



STERNBERG  
 49231-12 12 cm, 4 <sup>3</sup>/<sub>4</sub>"  
 49231-14 14 cm, 5 <sup>1</sup>/<sub>2</sub>"  
 49231-16 16 cm, 6 <sup>1</sup>/<sub>4</sub>"



49235-19  
 19 cm, 7 <sup>1</sup>/<sub>2</sub>"

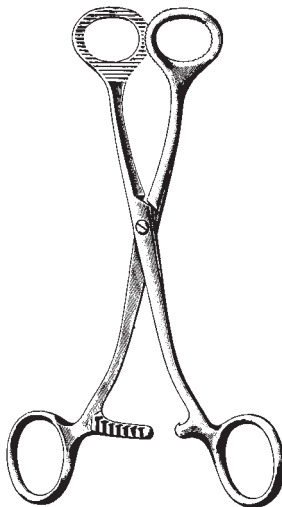

COLLIN  
 49250-16 16 cm, 6 <sup>1</sup>/<sub>4</sub>"  
 49250-18 18 cm, 7"



YOUNG  
 49255-16  
 16 cm, 6 <sup>1</sup>/<sub>4</sub>"



49255-99  
 Ersatzgummibacken (Paar)  
 Spare (Pair)  
 Repuesto (pareja)  
 Ricambio (coppia)



Mundsperrer  
 Mouth Gags  
 Abre-Bocas  
 Apribocca

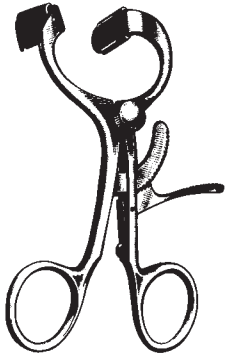

DOYEN-JANSEN (MOLT)  
 49265-12  
 12 cm, 4 3/4"

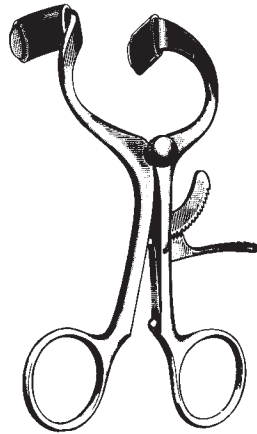

DOYEN-JANSEN (MOLT)  
 49265-14  
 14 cm, 5 1/2"

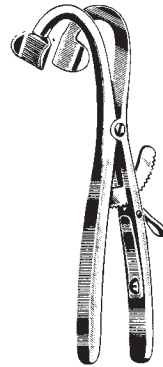

DENHART  
 49267-12  
 12 cm, 4 3/4"

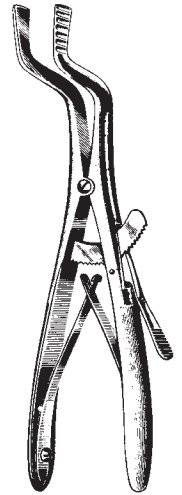

ROSER-KOENIG  
 49270-16 16 cm, 6 1/4"  
 49270-19 19 cm, 7 1/2"

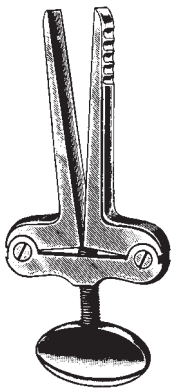

HEISTER  
 49272-13  
 13 cm, 5 1/8"

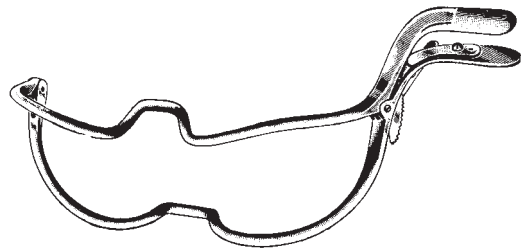

JENNINGS  
 49274-09 9 cm, 3 1/2"  
 49274-11 11 cm, 4 3/8"  
 49274-13 13 cm, 5 1/8"  
 49274-15 15 cm, 6"

Zungenspatel, Mundsperrer  
 Tongue depressor, Mouth Gags  
 Baja-lengua, Abrebocas  
 Abbassalingua, Apribocca



linke Seite  
 left side  
 izquierda  
 lato sinistro

rechte Seite  
 right side  
 derecha  
 lato destro

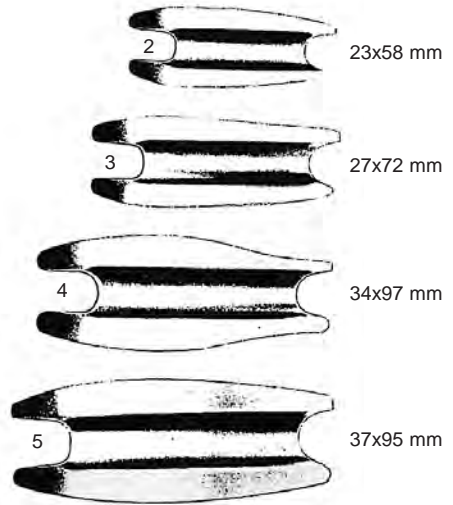

2 23x58 mm

3 27x72 mm

4 34x97 mm

5 37x95 mm

RING

- |          |        |          |
|----------|--------|----------|
| 49287-02 | Fig. 2 | 49288-02 |
| 49287-03 | Fig. 3 | 49288-03 |
| 49287-04 | Fig. 4 | 49288-04 |
| 49287-05 | Fig. 5 | 49288-05 |

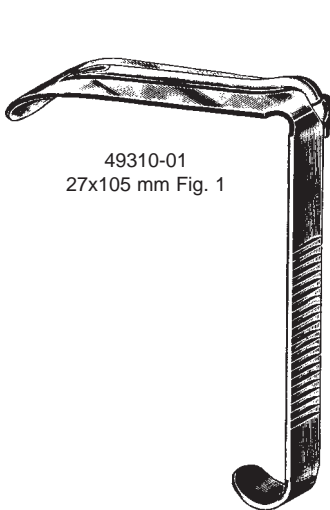

49310-01  
 27x105 mm Fig. 1

DAVIS-BOYLE  
 49310-00  
 compl.



49310-02  
 25x90 mm Fig. 2



49310-03  
 25x75 mm Fig. 3



49310-04  
 22x60 mm Fig. 4



49310-05  
 20x25 mm Fig. 5

49310-08 Silikoneinlagen/Silicone pads  
 inserto de silicona/inserto in silicone

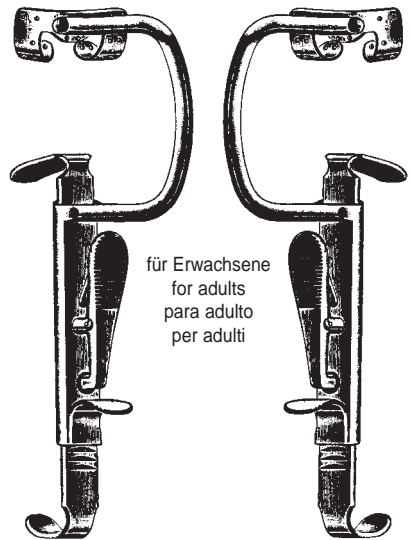

für Erwachsene  
 for adults  
 para adulto  
 per adulti

49310-10  
 Sperrer allein, links  
 Gag only, left  
 Abre-boca suelta, izquierda  
 Apribocca solo, sinistra

49310-12  
 Sperrer allein, rechts  
 Gag only, right  
 Abre-boca suelta, derecha  
 Apribocca solo, destra

Mundsperrer  
 Mouth Gags  
 Abre-Bocas  
 Apribocca

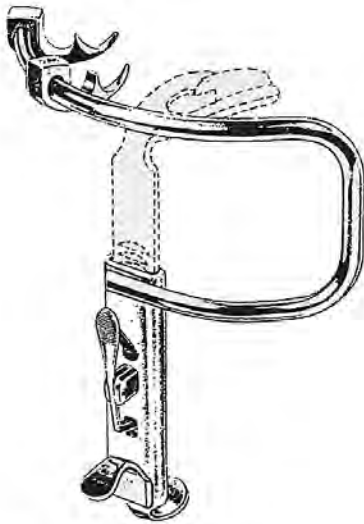

49315-01  
 Fig. 1



49315-02  
 Fig. 2



49315-03  
 Fig. 3

KILNER-DOUGHTY  
 49315-00  
 compl.

49315-10  
 Sperrer allein  
 Gag only  
 Abre-boca solo  
 Apribocca solo

**49317-00 DINGMANN, komplett**  
 mit 3 auswechselbaren Zungendrucker,  
 2 seitliche Wangenhaken und 2 Zahnhaken

with 3 interchangeable tongue depressors,  
 2 rotating cheek holders  
 2 movable tooth hooks and thread guide

con 3 baja lenguas intercambiables,  
 2 valvas giratorias p. los labios,  
 2 ganchos graduables

con 3 depressori intercambiabili,  
 2 valve laterali rotative  
 2 uncini a denti mobile

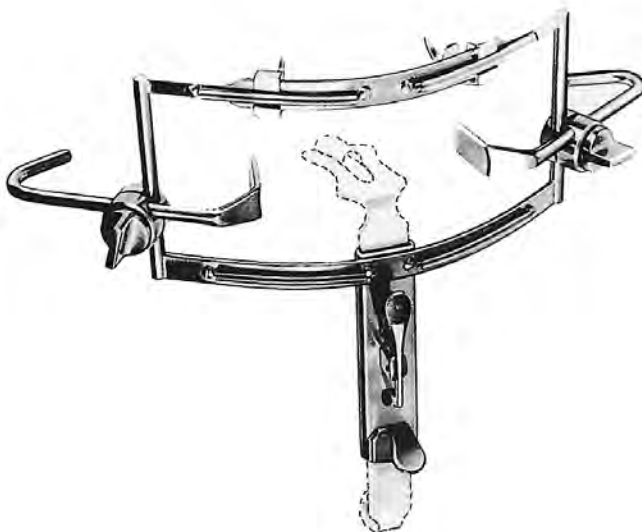

DINGMANN  
 49317-10  
 Sperrer allein, Gag only  
 Abre-boca solo, Apribocca solo



1 24x62 mm  
 49317-01



2 28x65 mm  
 49317-02



3 31x75 mm  
 49317-03

Mundsperrer  
Mouth Gag  
Abre-bocas  
Apribocca

49320-20  
Silikon-Schlauch  
Silicon Tubing  
tubo de silicona  
tubo in silicone

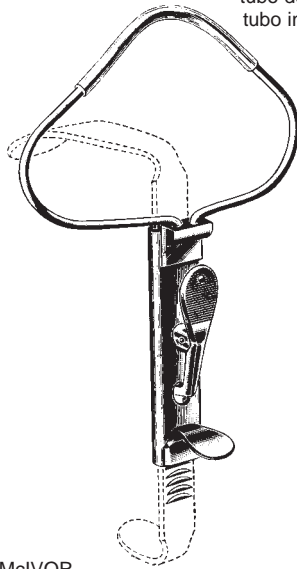

McIVOR  
49320-00  
compl.

49320-10

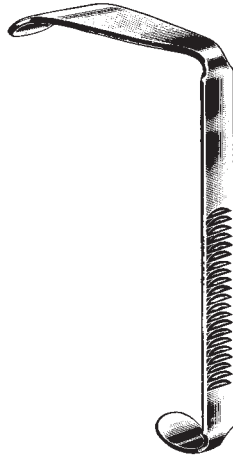

49320-01  
27x95 mm Fig. 1



49320-02  
22x85 mm Fig. 2



49320-03  
22x70 mm Fig. 3



DAVIS-MEYER  
49340-00

Zungenspatel  
Tongue blades  
Baja-lenguas  
Abbassalingua

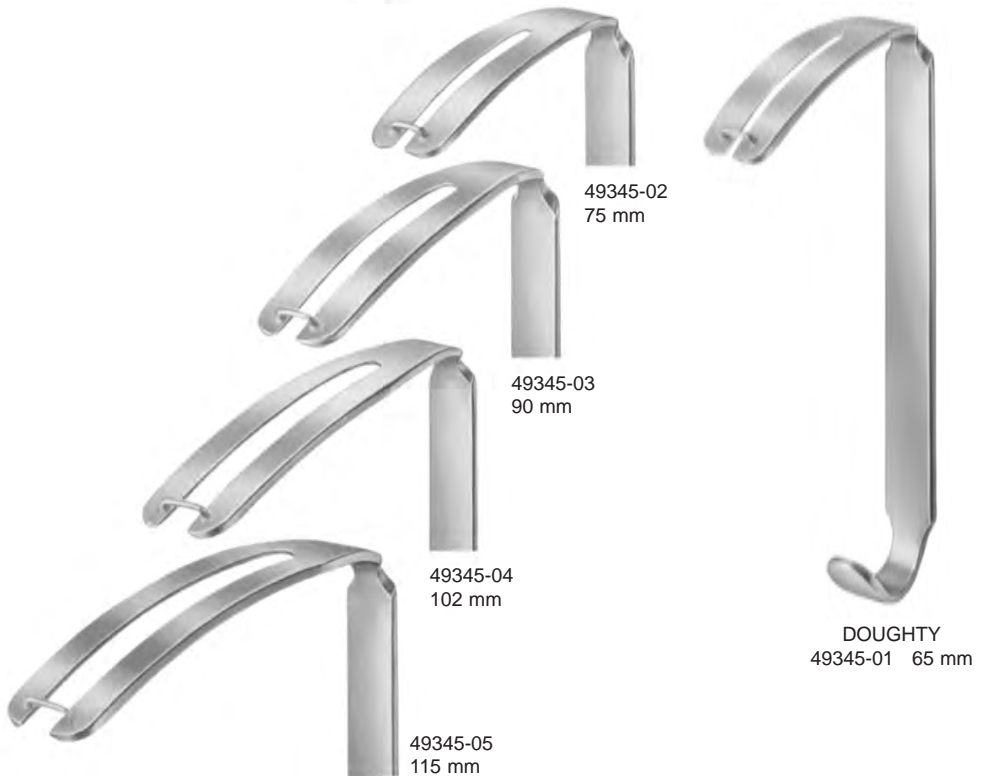
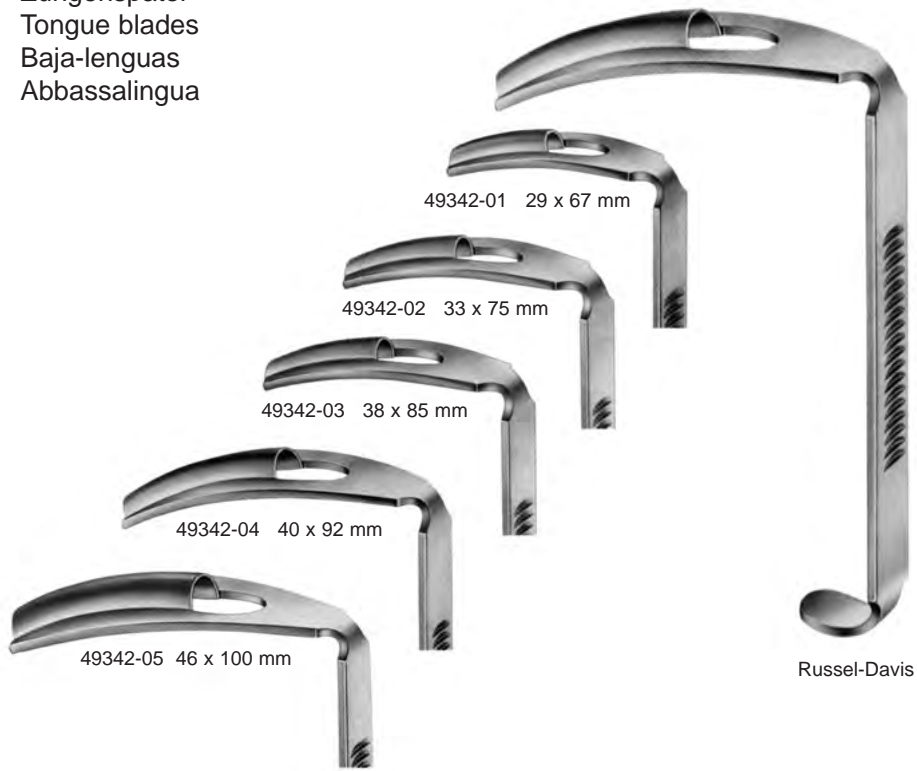

Mundkeil, Repositionszangen, Bruststütze  
 Oral Wedges, Disimpaction Forceps, Chest Support  
 Pinzas para reposiciones, Soporte de pecho  
 Pinze per riposizione, Supporto per petto

Holz  
 wood  
 madera  
 legno



MAUNDER  
 49360-10



NEGUS  
 49400-01



links  
 left side  
 izquierda  
 lato sinistro

ROWE

- 49501-22 22,5 cm, 8.9"
- 49501-23 23,5 cm, 9 1/4"
- 49501-24 24,0 cm, 9 1/2"



rechts  
 right side  
 derecha  
 lato destro

ROWE

- 49503-22 22,5 cm, 8.9"
- 49503-23 23,5 cm, 9 1/4"
- 49503-24 24,0 cm, 9 1/2"

Wundhaken für Mund-Kiefer-Gesicht  
 Retractors for Mouth-, Jaw- and Face Surgery  
 Separadores para cirugía plástica  
 Divaricatori per chirurgia plastica



49605-07  
 25x7 mm

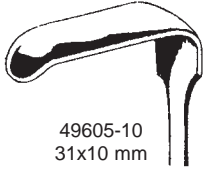

49605-10  
 31x10 mm

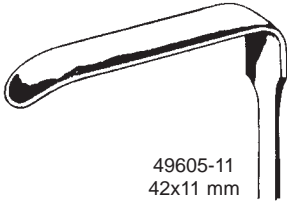

49605-11  
 42x11 mm

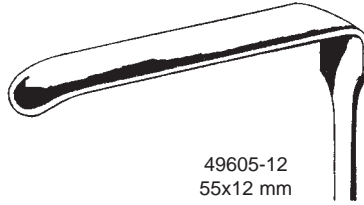

49605-12  
 55x12 mm



49605-14  
 70x14 mm

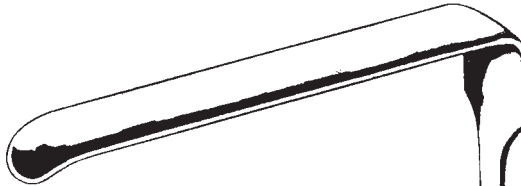

49605-16  
 80x16 mm



OBWEGESER  
 49605-07 - 49605-16  
 22 cm, 8 3/4"

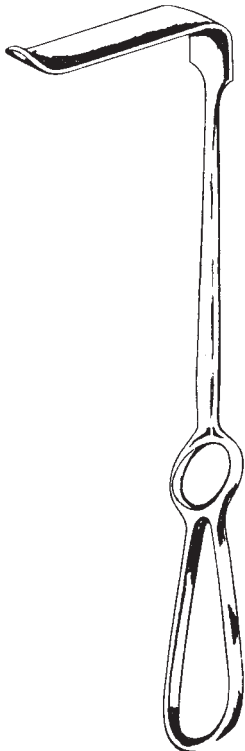

OBWEGESER  
 49610-12 - 49610-16  
 22 cm, 8 3/4"

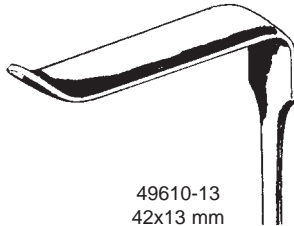

49610-13  
 42x13 mm

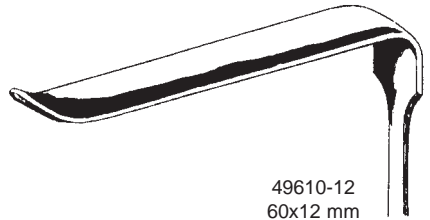

49610-12  
 60x12 mm

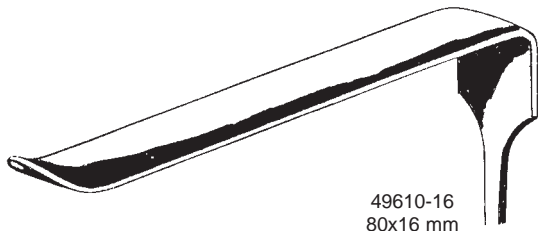

49610-16  
 80x16 mm

Wundhaken für Mund-Kiefer-Gesicht  
 Retractors, Raspatories for Mouth-, Jaw- and Face Surgery  
 Separadores Periostótomos para cirugía plástica  
 Divaricatori, Periostotomi per chirurgia plastica

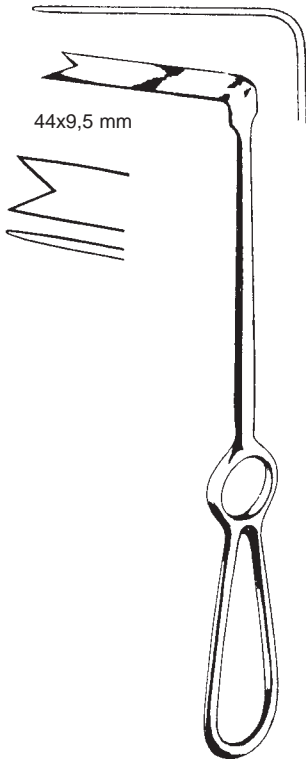

SPINA-NASALIS  
 49613-10  
 22 cm, 8 3/4"

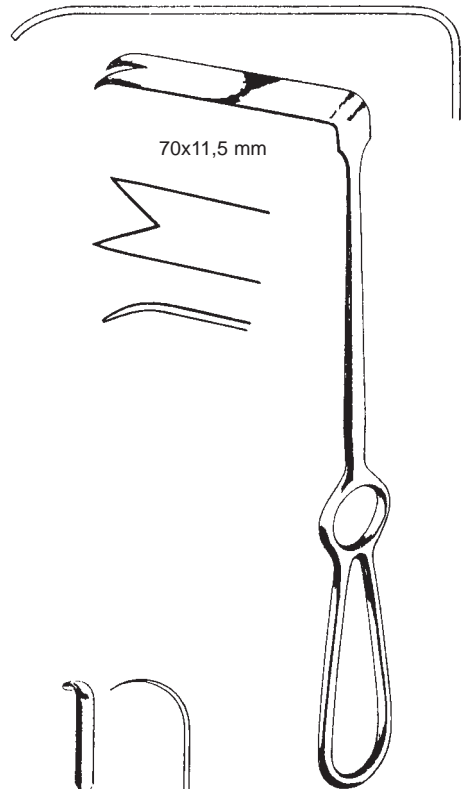

RAMUS  
 49615-12  
 22 cm, 8 3/4"



OBWEGESER  
 49620-15  
 15,5 cm, 6"

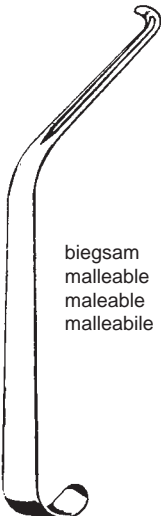

OBWEGESER  
 49623-16  
 16 cm, 6 1/4"

biegsam  
 malleable  
 malleable  
 malleabile



OBWEGESER  
 49627-01  
 21 cm, 8 1/4"

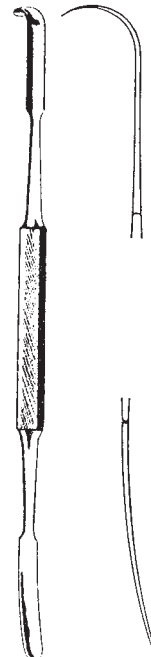

OBWEGESER  
 49630-02  
 20,5 cm, 8"



Raspatorien  
 Periosteal Elevators  
 Periostótomos  
 Periostotomi



OBWEGESER  
 49635-18  
 17,5 cm, 7"



OBWEGESER  
 49640-05 - 49640-09  
 20 cm, 8"

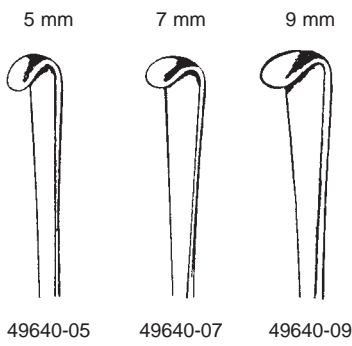

5 mm      7 mm      9 mm  
 49640-05      49640-07      49640-09



OBWEGESER  
 49650-06 - 49650-11  
 17,5 cm, 7"



49650-06



49650-07



49650-09



49650-11

Raspatorien, Osteotom, Unterkieferhaken, Ahle  
 Raspatories, Osteotome, Retractors for Mouth-, Jaw- and Face Surgery, Awls  
 Periostótomos, Osteotomos, Separadores para cirugía plástica, Agujas  
 Periostotomi, Osteotomo, Divaricatori per chirurgia plastica, Aghi

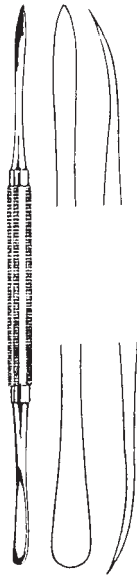

DINGMAN  
 49660-18  
 18 cm, 7"



OBWEGESER  
 49665-24  
 23,5 cm, 9 1/4"



HARGIS  
 49670-19  
 19 cm, 7 1/2"

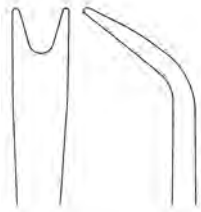

OBWEGESER  
 49670-23  
 23 cm, 9"

Intraorale Retraktoren  
Intra Oral Retractors  
Separadores intra orales  
Retrattori intraorali

26,5 / 16 mm



49671-01  
21 cm, 8 1/4"  
rechts  
right  
droite  
destra

26,5 / 16 mm



49671-02  
21 cm, 8 1/4"  
links  
left  
gauche  
sinistra

26,5 / 16 mm



49671-01 CL  
24,5 cm, 9 3/4"  
rechts  
right  
droite  
destra

26,5 / 16 mm



49671-02 CL  
24,5 cm, 9 3/4"  
links  
left  
gauche  
sinistra

Raspatorien  
Periosteal Elevators  
Legras  
Elevatori per periostio



HARGIS  
23 cm, 9"



49673-01  
6,5 mm  
rechts  
right  
derecha  
destra



49673-02  
9 mm  
rechts  
right  
derecha  
destra



49673-03  
6,5 mm  
links  
left  
izquierda  
sinistra

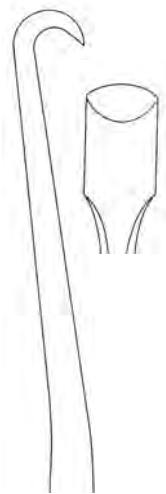

49673-04  
9 mm  
links  
left  
izquierda  
sinistra

Raspatorien, Ahle, Haken  
 Raspatories, Awls, Retractors for Mouth-, Jaw- and Face Surgery  
 Periostótomos, Agujas, Separadores para cirugía plástica  
 Periostotomi, Aghi, Divaricatori per chirurgia plastica



OBWEGESER  
 49675-18  
 18 cm, 7"

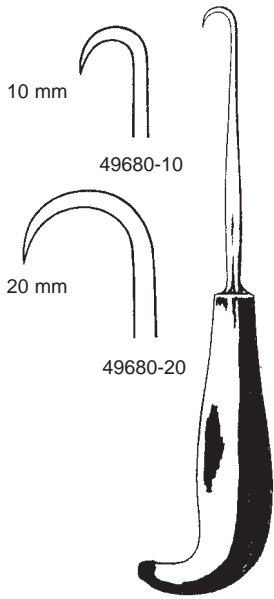

19 cm, 7 1/2"



DINGMAN  
 49685-21  
 21 cm, 8 1/4"

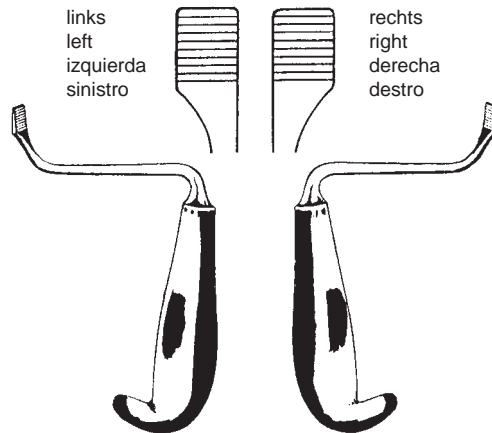

TESSIER  
 49691-15  
 15 cm, 6"

TESSIER  
 49692-15  
 15 cm, 6"

Intraorale Retraktoren  
Intra Oral Retractors  
Separadores intra orales  
Retrattori intraorali



49694-25  
25 cm, 9 3/4"  
12,5 / 27 mm

49694-25 CL  
28 cm, 11"  
12,5 / 27 mm

Sagittalspreizer  
Sagittal Split Separators  
Separadores sagitales  
Separatori sagittali

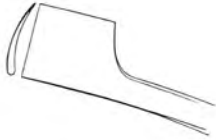

SMITH  
49695-01  
18,5 cm, 7 1/4"  
9 mm  
rechts  
right  
derecha  
destra

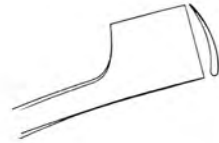

SMITH  
49695-02  
18,5 cm, 7 1/4"  
9 mm  
links  
left  
izquierda  
sinistra

Unterkieferkörperhaken  
Mandibular Body Retractor  
Separador para el cuerpo mandibular  
Separatore per il corpo mandibolare

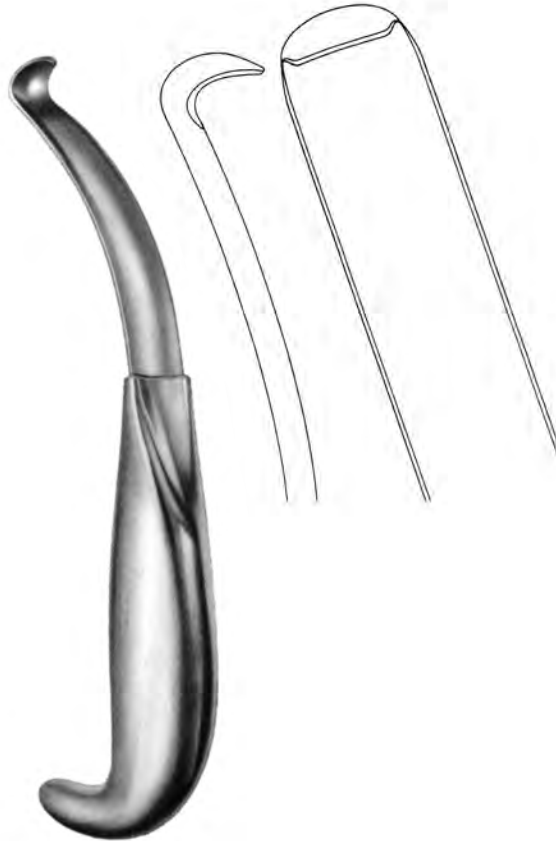

HARGIS  
49696-18  
18 cm, 7"



Osteotome  
Osteotome  
Osteótomos  
Osteotomi



49700-01  
21,5 cm, 8 1/2"



49700-02  
21,5 cm, 8 1/2"

Blattosteotom  
Blade Osteotomes  
Osteótomos de hoja  
Osteotomo a lama



49705-08  
8 mm



49705-12  
12 mm



49705-16  
16 mm

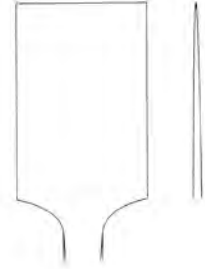

49705-20  
20 mm

OBWEGESER  
22 cm, 8 3/4"

Osteotome  
Osteotome  
Osteótomos  
Osteotomi

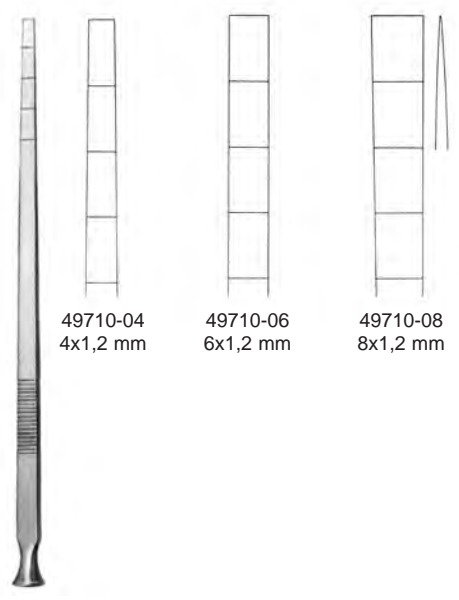

49710-04  
4x1,2 mm

49710-06  
6x1,2 mm

49710-08  
8x1,2 mm

EPKER  
18 cm, 7"

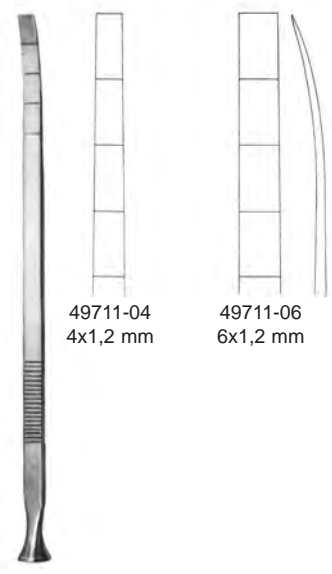

49711-04  
4x1,2 mm

49711-06  
6x1,2 mm

EPKER  
18 cm, 7"

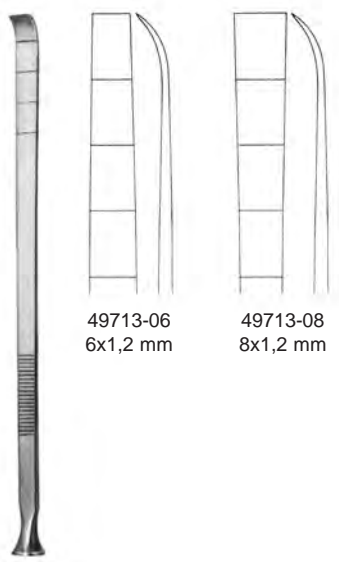

49713-06  
6x1,2 mm

49713-08  
8x1,2 mm

EPKER  
18 cm, 7"

Wundhaken, Tonsillen-Elevatoren, Tamponstopfer  
 Retractors, Tonsil-Elevators, Gauze packer  
 Separadores, Elevadores para amígdalas, Tamponeador  
 Divaricatori, Elevatori, Tamponatore

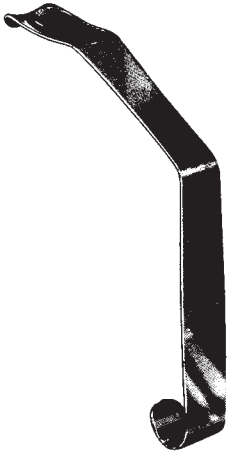

LOVE 15 cm, 6"  
 51103-18 18 mm  
 51103-20 20 mm  
 51103-22 22 mm



HOFER 51109-24  
 24 cm, 9 1/2"



NAGER 51111-23  
 23 cm, 9"



HURD 51131-22  
 22 cm, 8 1/4"



LOPEZ-REINKE 51133-23  
 23 cm, 9"



YANKAUER 51134-21  
 21 cm, 8 1/4"



51135-01



51135-02



HENKE 23 cm, 9"



CARPENTER 51139-25  
 25 cm, 10"



CARPENTER 51143-24  
 24 cm, 9 1/2"



LUNIATSCHEK 51151-19  
 19 cm, 7 1/2"

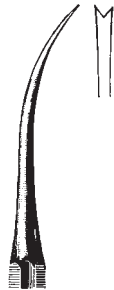

Tonsillen-Nadeln, Tonsillen-Messer

Tonsil Needles, Tonsil-Knives

Agujas para suturas de amígdalas, Bisturios para amígdalas

Aghi per tonsille, Coltelli per tonsille

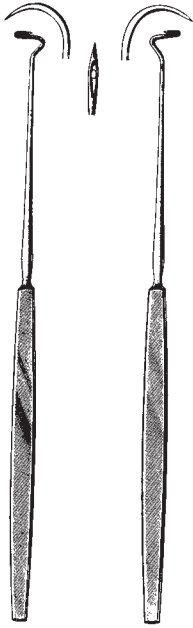

DUPUY-WEISS  
51165-22 51167-22  
22 cm, 8 3/4"



CLAUS  
51168-23  
23 cm, 9"



CLAUS-EICKEN  
51169-23  
23 cm, 9"



NAGER  
51170-24  
24 cm, 9 1/2"



FISHER  
51171-22  
22,5 , 9"



ABRAHAM  
51172-19  
19 cm, 7 1/2"



ABRAHAM  
51173-21  
21 cm, 8 1/4"



CANFIELD  
51174-21  
21 cm, 8 1/4"



BRUENINGS  
51177-23  
23 cm, 9"



DOUGLAS  
51178-21  
21 cm, 8 1/4"



DOUGLAS  
51179-17  
17 cm, 6 3/4"

Tonsillenzange  
 Tonsil Seizing Forceps  
 Pinzas para coger las amígdalas  
 Pinze per tonsille

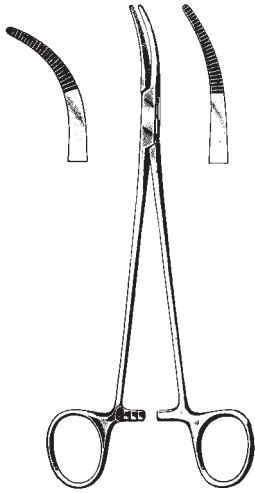

19 cm, 7 1/2"  
 SAWTELL    SCHNIDT  
 51181-19    51183-19

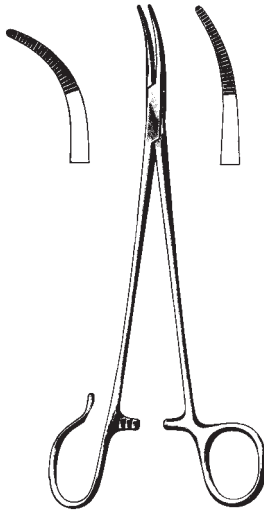

19 cm, 7 1/2"  
 SAWTELL    SCHNIDT  
 51185-19    51187-19

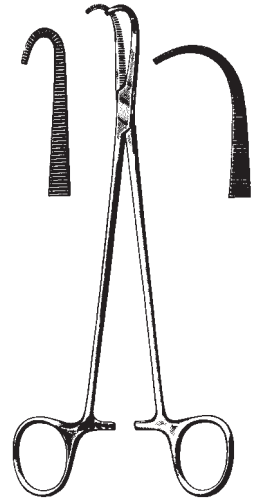

19 cm, 7 1/2"  
 NEGUS      NEGUS  
 51191-19    51193-19

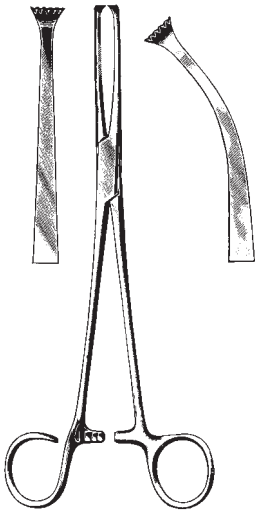

19 cm, 7 1/2"  
 COLVER  
 51202-19    51203-19

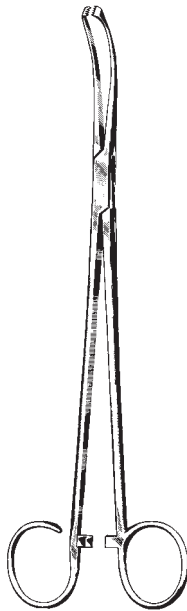

WHITE  
 51205-18    18 cm, 7"  
 51205-23    23 cm, 9"

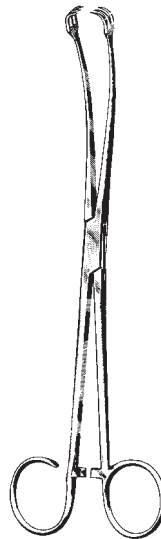

BALLENGER  
 51207-21  
 21,5 cm, 8 1/2"

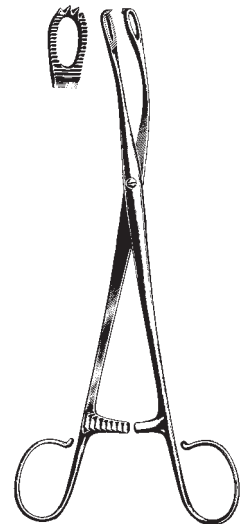

BLOHMKE  
 51209-20  
 20 cm, 8"

Tonsillen-Zangen u. -Pinzetten, Tonsillen-Kompressoren, Tonsillen-Schnürer  
 Tonsil-Forceps, Tonsil-Snares  
 Pinzas, Compresores para amígdalas, Cierra-nudos para amígdalas  
 Pinze, Compresori per tonsille, Serranodi per tonsille



ABRAHAM  
 51210-20  
 20 cm, 8"

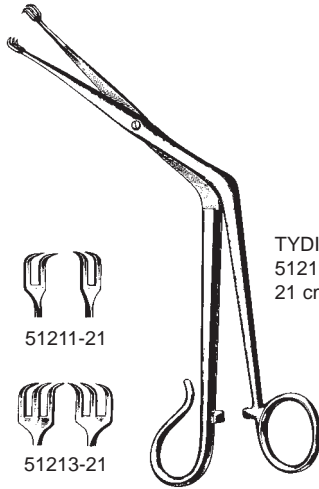

TYDING  
 51211-21 - 51213-21  
 21 cm, 8 1/4"



51211-21



51213-21

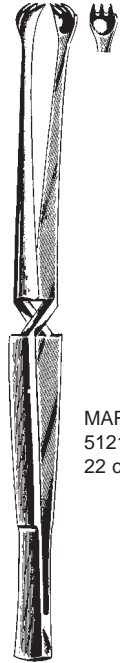

MARSCHIK  
 51219-22  
 22 cm, 8 3/4"



EVES  
 51250-28  
 28 cm, 11"



EVES  
 51252-28  
 28 cm, 11"



BRUENINGS  
 51256-28  
 28 cm, 11"

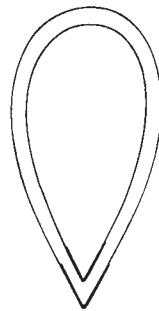

51257-40 40 mm  
 51257-50 50 mm  
 Pack of 100 pcs



51259-03 0,3 mm  
 51259-04 0,4 mm  
 51259-05 0,5 mm  
 Pack of 12 pcs

Tonsillotom  
Tonsillectomes  
Amigdalótomos  
Tonsillotomi

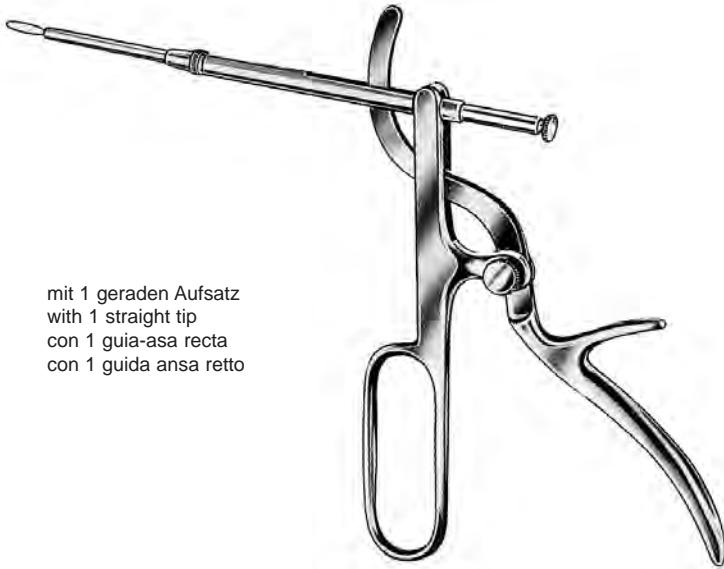

mit 1 geraden Aufsatz  
with 1 straight tip  
con 1 guida-asa recta  
con 1 guida ansa retto

TYDING  
51260-00



Tonsillotom, Spritzen, Septum Nadeln  
 Tonsillectomes, Syringes, Septum needles  
 Amigdalótomos, Jeringas, Septum aguja  
 Tonsillotomi, Siringhe, Septum aghi

Aufsatz allein  
 blade only  
 hoja sola  
 lama sola

51270-01

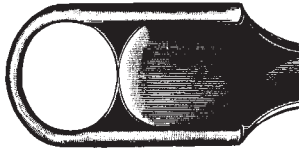

1

51270-02

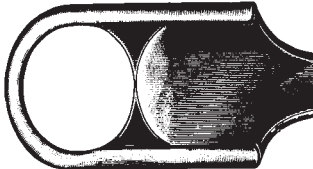

2

51270-03

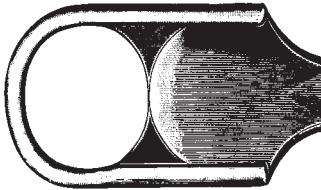

3

51270-04  
 Handgriff allein  
 Handle only  
 mango para  
 manipolo solo

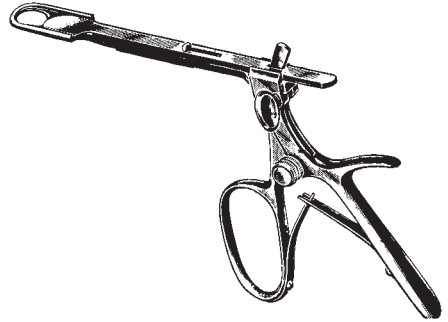

SLUDER-BALLENGER  
 51270-00  
 mit 3 Aufsätzen  
 with 3 blades  
 con 3 hojas  
 con 3 lame

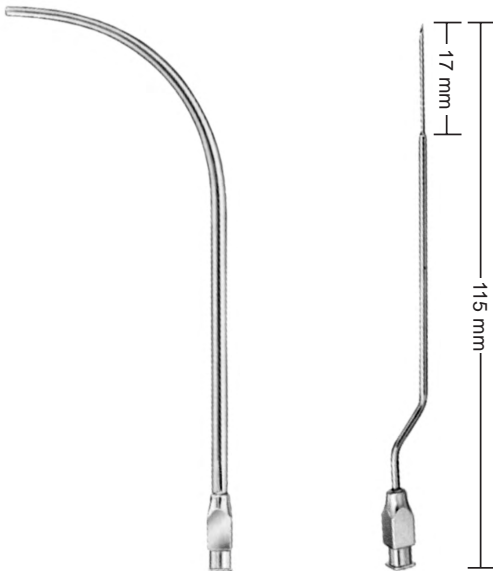

51291-00  
 2,5 mm Ø

51293-00  
 0,8 mm Ø

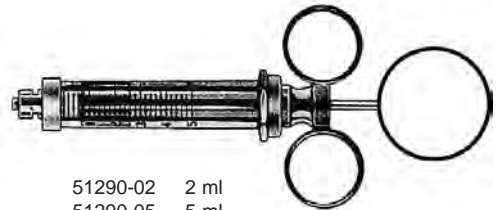

51290-02 2 ml  
 51290-05 5 ml  
 51290-10 10 ml  
 51290-20 20 ml



51292-00



51293-45  
 45°

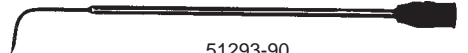

51293-90  
 90°

Septum-Schere, Kehlkopfpolypenzangen, Deckelhalter  
 Septum-Scissors, Laryngeal Polypus Forceps, Epiglottis Retractor  
 Tijeras para septo, Pinzas para pólipos laríngeos, Depresor para epiglotis  
 Forbice per il setto nasale, Pinze per polipi laringei, Depressore per epiglottide



KILLIAN  
 53102-20  
 20 cm, 8"



53101-22



53103-22



JACKSON  
 53101-22 - 53103-22  
 22 cm, 8 3/4"

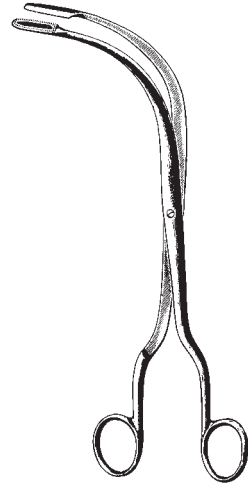

FRAENKEL  
 53111-18  
 18 cm, 7"

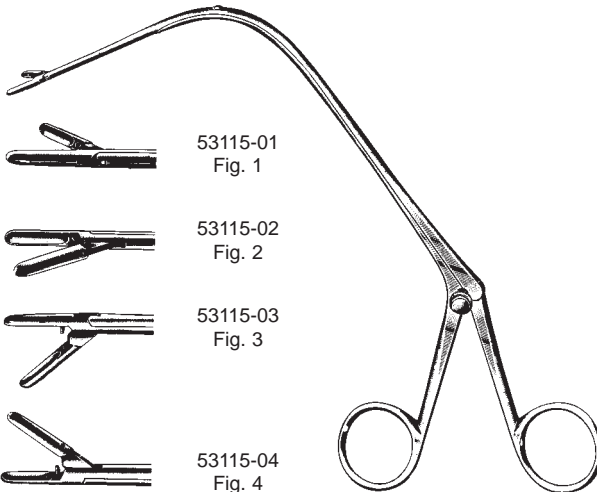

53115-01  
 Fig. 1

53115-02  
 Fig. 2

53115-03  
 Fig. 3

53115-04  
 Fig. 4

JURASZ  
 53115-01 - 53115-04  
 23 cm, 9"



REICHERT  
 53121-24  
 24 cm, 9 1/2"

Universalgriffe, Verlängerungsrohre, Aufsätze  
 Universal Handles, Interchangeable Tips, Tips  
 Mangos universales y Tubos de extension, Puntas  
 Manici universali e Tubi di prolungamento, Terminale laringeo

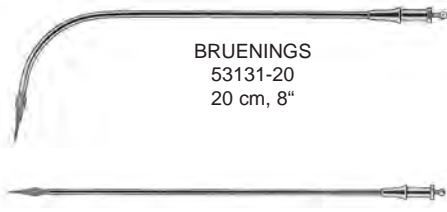

BRUENINGS  
 53131-20  
 20 cm, 8"

BRUENINGS  
 53132-20 20 cm, 8"      53132-50 50 cm, 19 3/4"  
 53132-30 30 cm, 11 3/4"      53132-60 60 cm, 23 1/2"  
 53132-40 40 cm, 15 3/4"



HUBER  
 53130-00



FRAENKEL  
 53150-00



SEIFERT  
 53152-00



FRAENKEL  
 53154-00



SCHEINMANN  
 53155-00



SCHEINMANN  
 53157-00



○ 53158-02  
 ○ 53158-03  
 BRUENINGS  
 53158-02 - 53158-03

○ 53160-02

○ 53160-03



BRUENINGS  
 53160-02 - 53160-03



LANGE  
 53162-00



⊕ 53164-01  
 ⊕ 53164-02  
 KRAUSE  
 53164-01 - 53164-02



KRAUSE  
 53166-00



SCHUMACHER  
 53170-00



BARACANI  
 53175-00

⊔ 53177-01

⊔ 53177-02



CORDES  
 53177-01 - 53177-02

Broncho-Oesophagoskopiezangen, Kehlkopfspiegel, Griffe  
 Broncho-Esophagoscopy Forceps, Laryngeal Mirrors, Handles  
 Pinzas para bronco-esofagoscopia, Espejos laringeos, Mangos  
 Pinze per bronco-esofagoscopia, Specchi laringei, Manici

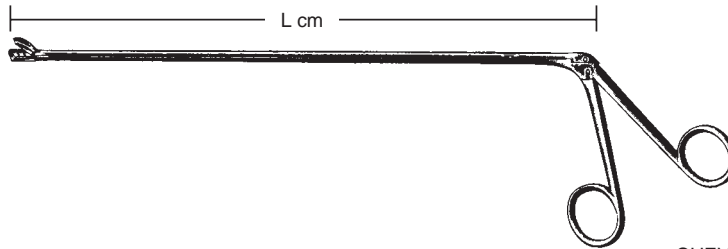

CHEVALIER-JACKSON  
 53230-01 - 53260-08



cm	Fig. 1	Fig. 2	Fig. 3	Fig. 4	Fig. 5	Fig. 6	Fig. 7	Fig. 8
30 / 11 3/4"	53230-01	53230-02	53230-03	53230-04	53230-05	53230-06	53230-07	53230-08
40 / 15 3/4"	53240-01	53240-02	53240-03	53240-04	53240-05	53240-06	53240-07	53240-08
50 / 19 3/4"	53250-01	53250-02	53250-03	53250-04	53250-05	53250-06	53250-07	53250-08
60 / 23 1/2"	53260-01	53260-02	53260-03	53260-04	53260-05	53260-06	53260-07	53260-08

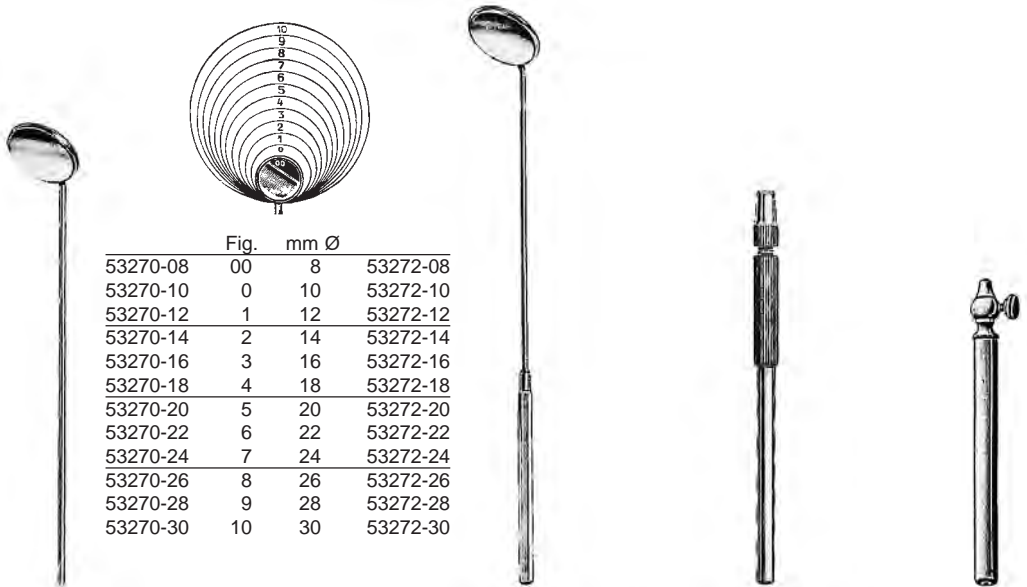

Fig.	mm Ø	
53270-08	00	8
53270-10	0	10
53270-12	1	12
53270-14	2	14
53270-16	3	16
53270-18	4	18
53270-20	5	20
53270-22	6	22
53270-24	7	24
53270-26	8	26
53270-28	9	28
53270-30	10	30

53270-08 - 53270-30

53272-08 - 53272-30

53274-12

53276-10

Mikro-Rohrschaftzangen  
 Micro Laryngeal Forceps  
 Pinzas para la micro-cirugía de la laringe  
 Pinze ad asta tubolare per microchirurgia

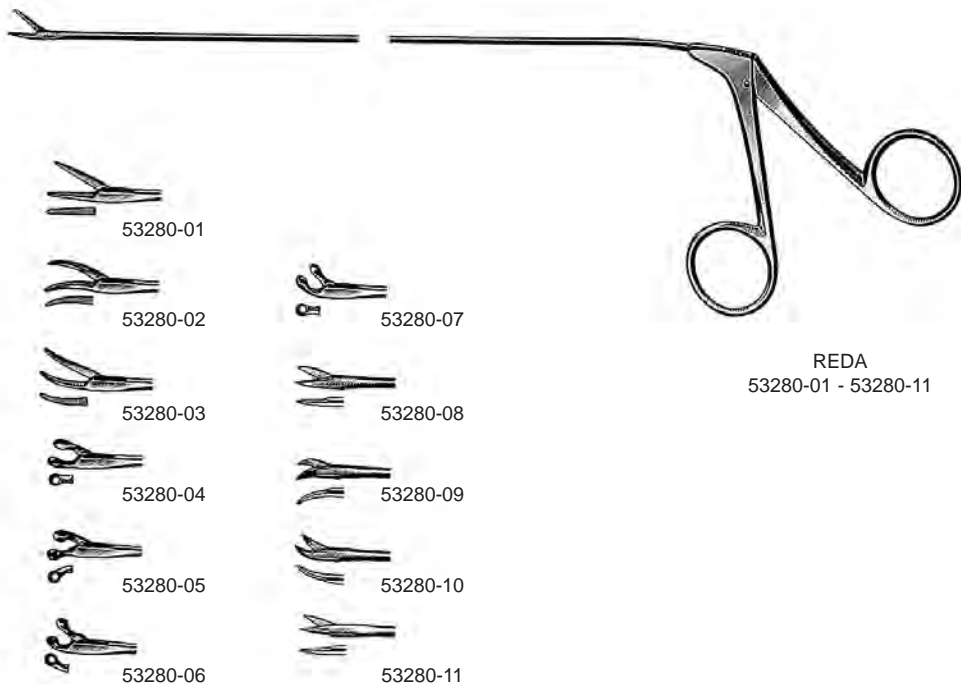

REDA  
 53280-01 - 53280-11

**REDA Mikro-Rohrschaftzangen 22 cm (8 3/4")**

- 53280-01 gerieftes Maul, gerade 1,5 x 10 mm
- 53280-02 gerieftes Maul, links gebogen 1,5 x 8,5 mm
- 53280-03 gerieftes Maul, rechts gebogen 1,5 x 8,5 mm
- 53280-04 Löffelmaul, gerade 2,5 mm
- 53280-05 Löffelmaul, links abgewinkelt 2,5 mm
- 53280-06 Löffelmaul, rechts abgewinkelt 2,5 mm
- 53280-07 Löffelmaul, aufwärts abgewinkelt 2,5 mm
- 53280-08 Schere, gerade, vertikal
- 53280-09 Schere, links gebogen
- 53280-10 Schere, rechts gebogen
- 53280-11 Schere, horizontal schneidend, gerade

**REDA Micro-Laryngeal Forceps 22 cm (8 3/4")**

- 53280-01 Grasping tip, straight, serrated, 1,5 x 10 mm
- 53280-02 Grasping tip, curved to left, serrated, 1,5 x 8,5 mm
- 53280-03 Grasping tip, curved to right, serrated, 1,5 x 8,5 mm
- 53280-04 Cup forceps, straight, 2,5 mm
- 53280-05 Cup forceps, angled to left, 2,5 mm
- 53280-06 Cup forceps, angled to right, 2,5 mm
- 53280-07 Cup forceps, angled up, 2,5 mm
- 53280-08 Scissors, straight, vertical
- 53280-09 Scissors, curved to left
- 53280-10 Scissors, curved to right
- 53280-11 Scissors, straight, horizontal

**REDA Pinza microlaringea 22 cm (8 3/4")**

- 53280-01 boca estriada recta 1,5 x 10 mm
- 53280-02 boca estriada curva a la izquierda 1,5 x 8,5 mm
- 53280-03 boca estriada curva a la derecha 1,5 x 8,5 mm
- 53280-04 boca redonda cortante recta 2,5 mm Ø
- 53280-05 boca redonda cortante angulada al la izquierda 2,5 mm Ø
- 53280-06 boca redonda cortante angulada a la derecha 2,5 mm Ø
- 53280-07 boca redonda cortante angulada hacia arriba 2,5 mm Ø
- 53280-08 Tijera recta corte vertical
- 53280-09 Tijera curva a la izquierda
- 53280-10 Tijera curva a la derecha
- 53280-11 Tijera recta corte horizontal

**REDA Pinze ad asta tubolare per microchirurgia 22 cm (8 3/4")**

- 53280-01 morsi zigrinati, retti, 1,5 x 10 mm
- 53280-02 morsi zigrinati, curvi a sinistra, 1,5 x 8,5 mm
- 53280-03 morsi zigrinati, curvi a destra, 1,5 x 8,5 mm
- 53280-04 morsi a forma di cucchiaio rotondo retto, 2,5 mm
- 53280-05 morsi a forma di cucchiaio rotondo angolati a sinistra, 2,5 mm
- 53280-06 morsi a forma di cucchiaio rotondo angolati a destra, 2,5 mm
- 53280-07 morsi a forma di cucchiaio rotondo angolati in alto, 2,5 mm
- 53280-08 forbici, rette, taglio verticale
- 53280-09 forbici, curve a sinistra
- 53280-10 forbici, curve a destra
- 53280-11 forbici, rette, taglio orizzontale

Instrumente für Tracheotomie  
 Instruments for tracheotomy  
 Instrumentos tracheotomia  
 Strumenti per la tracheotomia

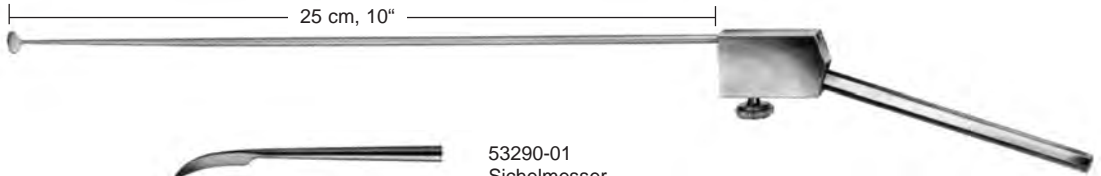

53290-01  
 Sichelmesser  
 micro-laryngeal sickle  
 microlaringeo cuchillo de hoz  
 Coltello falciato



53290-02  
 Schälmesser, quer, oval  
 micro-laryngeal separador oval, horizontal  
 microlaringeo separador ovalado, horizontal  
 Seperatore ovale verticale



53290-03  
 Schälmesser, längs, oval  
 micro-laryngeal separador oval, vertical  
 microlaringeo separador ovalado, vertical  
 Seperatore ovale orizzontale



53290-04  
 Schälmesser, 45° abgewinkelt  
 micro-laryngeal round cutting knife, 45° angled  
 microlaringeo cuchillo para cortes redondos, 45° angulado  
 Seperatore angolato 45°



53290-05  
 Häkchen, 90° gebogen stumpf  
 micro-laryngeal hook 90° angled, blunt  
 microlaringeo ganchito 90° angulado, romo  
 Uncino angolato 90° smusso



53290-06  
 Häkchen, 30° retrograd gebogen  
 micro-laryngeal probe, 30° backwards curved blunt with button  
 microlaringeo ganchito, 30° curvo retrogrado  
 Uncino angolato retrogrado 30°



53290-07  
 Fadengabel  
 micro-laryngeal ligature adjuster  
 microlaringeo horquilla de hilos  
 Forchetta da sutura

53290-08  
 Handgriff für Stabinstrumente  
 Handle for microlaryngeal instruments  
 Mango para microlaringeos instrumentos  
 Manico per strumenti microlaringei



Tracheal Dilatoren, Trachealhaken, Tracheal-Wundspreizer  
 Trachea Dilators, Trachea hooks, Trachel Retractors  
 Dilatadores para la tráquea, Ganchos para traqueotomía, Retractor traqueal  
 Dilatatori per tracheotomia, Ganci per tracheotomia, Divaricatori tracheali

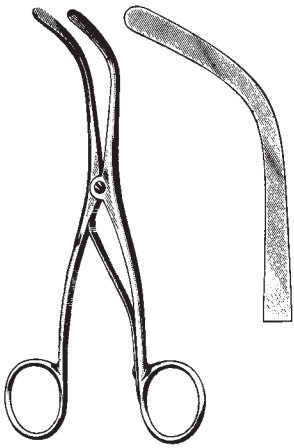

TROUSSEAU-BABY  
 55111-13 13 cm, 5 1/8"

TROUSSEAU  
 55111-14 14 cm, 5 1/2"

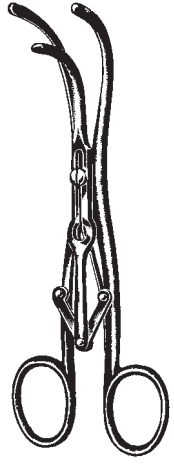

LABORDE  
 55113-14  
 14 cm, 5 1/2"



BOSE  
 55115-07  
 7 cm, 2 3/4"



JACKSON  
 55116-15  
 15 cm, 6"



JACKSON  
 55117-17  
 17 cm, 6 3/4"

Trachealhaken, Kanüle  
 Trachea Hooks, Tubes  
 Ganchos para traqueotomía, Cánula  
 Ganci per tracheotomia, Cannule



ITERSON  
 55118-16 - 55119-16  
 16 cm, 6 1/4"



NEWS  
 55120-15  
 15 cm, 6"

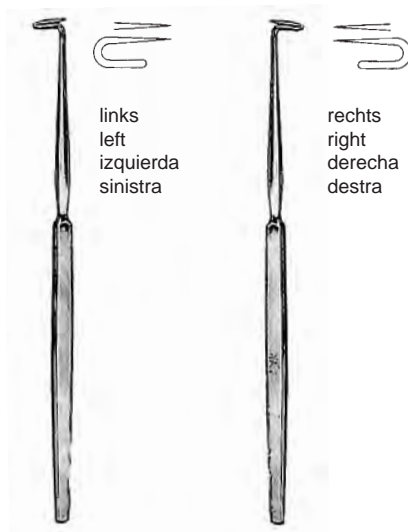

BOSE  
 55122-16  
 16 cm, 6 1/4"

BOSE  
 55124-16  
 16 cm, 6 1/4"



WAGENER-MOSHER  
 55151-05 5 mm  
 55151-07 7 mm  
 55151-09 9 mm



Tracheotomie-Besteck  
 Tracheotomy Set  
 Estuche para Traqueotomía  
 Set per Tracheotomia

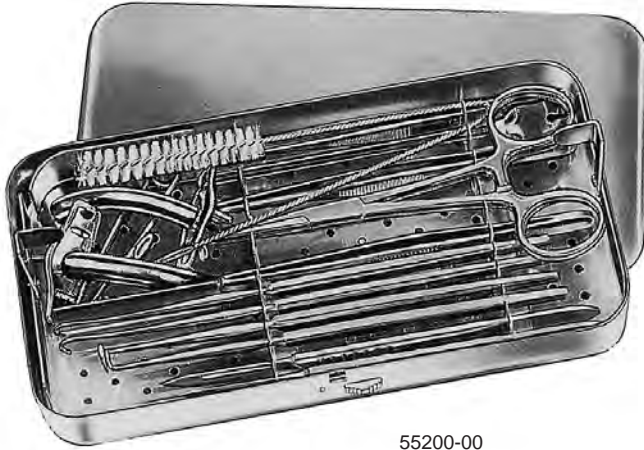

55200-00

Tracheotomie-Besteck

in Metall-Etui, bestehend aus:

- 1 Griff und 1 Klinge, Fig. 20
- 1 Griff und 1 Klinge, Fig. 23
- 1 anat. Pinzette, 13 cm (5 1/8")
- 2 chir. Pinzetten, 13 cm (5 1/8"), 1x2 Zähne
- 2 Pean-Klemmen, 13 cm (5 1/8")
- 1 Hohlsonde, 13 cm (5 1/8")
- 1 Trachealdilatator
- 2 Trachealhäkchen Iterson stumpf
- 1 Trachealhäkchen Bose scharf, links
- 1 Trachealhäkchen Bose scharf, rechts
- 1 Trachealkanüle Luer Standard, Fig. 3
- 1 Trachealkanüle Luer Standard, Fig. 4
- 1 Reinigungsbürste

Estuche para Traqueotomía

en estuche de metal, compuesto de:

- 1 Mango con 1 hoja fig. 20
- 1 Mango con 1 hoja fig. 23
- 1 Pinza de disección, 13 cm (5 1/8")
- 1 Pinza de disección, con 1x2 dientes de ratón, 13 cm (5 1/8")
- 2 Pinzas hemostáticas Pean, 13 cm (5 1/8")
- 1 Sonda acanalada, 13 cm (5 1/8")
- 1 Dilatador traqueal
- 2 Iterson separadores traqueales, romos
- 1 Bose separador traqueal, agudo, lado izquierdo
- 1 idem, lado derecho
- 1 Luer Cánula traqueal, modelo standard, Fig. 3
- 1 idem, Fig. 4
- 1 Cepillo de limpieza

Tracheotomy Set

in metal case, consisting of:

- 1 Handle with 1 blade, Fig. 20
- 1 Handle with 1 blade, Fig. 23
- 1 Thumb Forceps, 13 cm (5 1/8")
- 1 Tissue Forceps, 13 cm (5 1/8"), 1x2 teeth
- 2 Pean Artery Forceps, 13 cm (5 1/8")
- 1 Grooved Director, 13 cm (5 1/8")
- 1 Trachea Dilator
- 1 Iterson Trachea Retractors, blunt
- 1 Bose Trachea Retractor, sharp, left hand side
- 1 ditto, right hand side
- 1 Luer Trachea Tube, Standard, Fig. 3
- 1 ditto, Fig. 4
- 1 Cleaning Brush

Set per tracheotomia

in scatola di metallo, composto da:

- 1 Manico di bisturi con 1 lama fig. 20
- 1 Manico di bisturi con 1 lama fig. 23
- 1 Pinza per dissezione, cm 13 (5 1/8")
- 1 Pinza per dissezione con denti 1x2, cm 13 (5 1/8")
- 2 Pinze emostatiche Pean, cm 13 (5 1/8")
- 1 Sonda scanalata, cm 13 (5 1/8")
- 1 Dilatatore traqueale
- 2 Uncini tracheali Iterson, smussi
- 1 Uncino tracheale Bose, acuto, lato sinistro
- 1 item, lato destro
- 1 Cannula tracheale Luer standard, Fig. 3
- 1 item, Fig. 4
- 1 Spazzolino per pulire

Tracheal-Kanülen, Schilddrüsenhaken, Sonde, Kropffabzange, Muskelklemme  
 Tracheal Tubes, Thyroid Gland Retractor, Directors-Enucleators, Goitre Seizing Forceps, Muscular Clamp  
 Cánulas traqueales, Separador para la glándula tiroidea, Sondas acanaladas,  
 Pinza para coger el bocio, Pinza-clamp para músculos  
 Cannule tracheali, Divaricatori per la tiroide, Sonde, Pinze per gozzo, Pinza muscolare



LUER

Neusilber  
 German silver  
 alpaca  
 argentone  
 45-90 mm  
 55220-04  
 55220-05  
 55220-06  
 55220-07  
 55220-08  
 55220-09  
 55220-10  
 55220-11  
 55220-12  
 55220-13



CHEVALIER-JACKSON

Neusilber  
 German silver  
 alpaca  
 argentone  
 45-90 mm  
 55240-04  
 55240-05  
 55240-06  
 55240-07  
 55240-08  
 55240-09  
 55240-10  
 55240-11  
 55240-12  
 55240-13

Fig.	Ø mm	Länge des Außenrohrs Length of outer tube Largo de la cánula exterior Lunghezza del tubo esterno
0	4	45
1	5	50
2	6	55
3	7	60
4	8	65
5	9	70
6	10	75
7	11	80
8	12	85
9	13	90

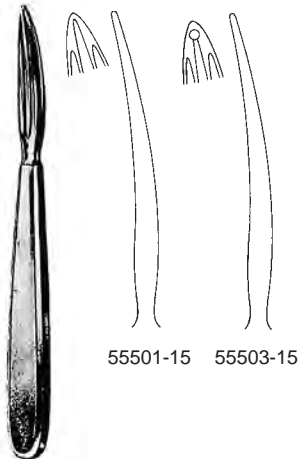

55501-15 55503-15

KOCHER  
 55501-15 - 55503-15  
 15 cm, 6"



SCHOENBORN  
 55511-21  
 21 cm, 8 1/4"



LAHEY  
 55520-15 15 cm, 6"  
 55520-20 20 cm, 8"

MASTIN  
 55523-17  
 17 cm, 6 3/4"

Rippenscheren, Sternummeißel

Rib Shears

Costótomos

Costotomi

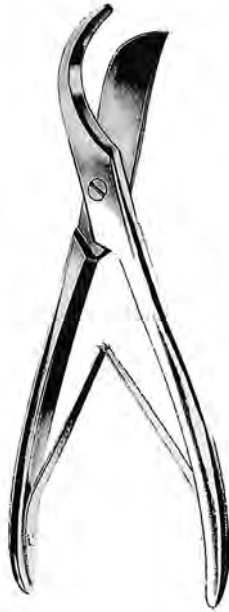

57102-23  
23 cm, 9"



57105-22  
22 cm, 8 3/4"



GLUCK  
57107-22  
22 cm, 8 3/4"

mit ziehendem Schnitt  
with eccentric sliding blade  
con hoja de retroacción  
con lama di retroazione



STILLE  
57111-21  
21 cm, 8 1/4"



CORYLLOS  
57123-35  
35 cm, 13 3/4"



CORYLLOS  
57125-35  
35 cm, 13 3/4"

Rippenscheren, Sternumscheren  
 Rib Shears, Sternum Scissors  
 Costótomos, Tijeras de esternón  
 Costotomi, Forbici per sterno



BETHUNE  
 57126-34  
 34 cm, 13 1/2"



SAUERBRUCH  
 57131-26  
 26 cm, 10 1/4"



GIERTZ-STILLE  
 57137-27  
 27 cm, 10 1/2"



SCHUMACHER  
 57138-21  
 21 cm, 8 1/4"



SAUERBRUCH-FREY  
 57141-36  
 36 cm, 14.2"

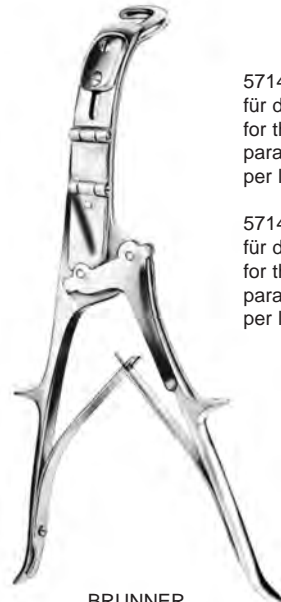

BRUNNER  
 57146-28 - 57147-28  
 28 cm, 11"

57146-28  
 für die rechte Hand  
 for the right hand  
 para la mano derecha  
 per la mano destra

57147-28  
 für die linke Hand  
 for the left hand  
 para la mano izquierda  
 per la mano sinistra

Rippensperrer  
 Rib Spreaders  
 Separadores costales  
 Divaricatori costali

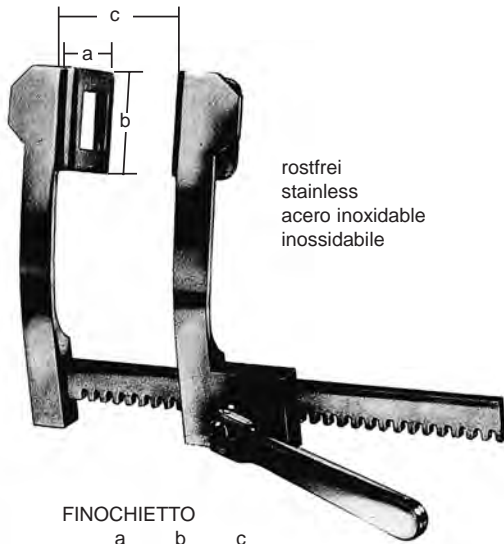

rostfrei  
 stainless  
 acero inoxidable  
 inossidabile

FINOCHIETTO

	a	b	c
	mm	mm	mm
57210-16	38	44	160
57210-20	52	62	200
57210-25	65	85	250

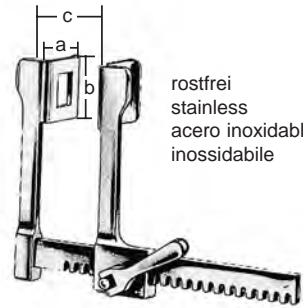

rostfrei  
 stainless  
 acero inoxidable  
 inossidabile

FINOCHIETTO-BABY

	a	b	c
	mm	mm	mm
57214-75	18	20	75

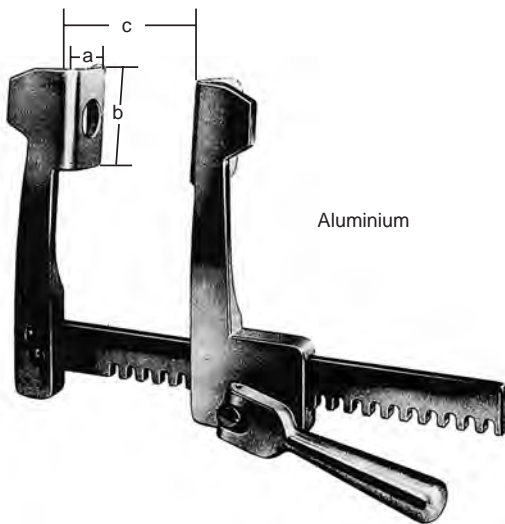

Aluminium

FINOCHIETTO

	a	b	c
	mm	mm	mm
57230-13	38	44	135
57230-17	52	62	175
57230-18	85	65	175

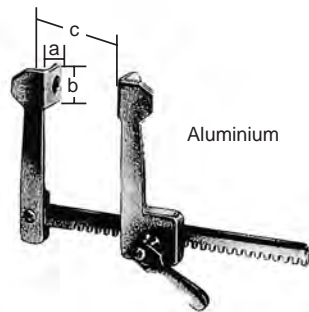

Aluminium

FINOCHIETTO-BABY

	a	b	c
	mm	mm	mm
57234-75	15	15	75

Rippensperrer  
Rib Spreaders  
Separadores costales  
Divaricatori costali

FINOCHIETTO-BURFORD

	a	b	c
	mm	mm	mm
57236-20	65	62	200
	47	62	
57236-25	65	62	250
	47	62	
57236-30	65	62	300
	47	52	



rostfrei  
stainless  
acero inoxidable  
inossidabile

Erwachsene  
Adult Size  
para adultos  
per adulti

FINOCHIETTO-BURFORD

	a	b	c
	mm	mm	mm
57242-20	47	62	200
	65	62	
57242-25	47	62	250
	65	62	
57242-30	47	62	300
	65	62	



Aluminium

Kinder  
Child Size  
para niños  
per bambini

FINOCHIETTO-BURFORD

	a	b	c
	mm	mm	mm
57244-13	34	42	135
	48	42	



Aluminium

Rippensperrer  
 Rib Spreaders  
 Separadores costales  
 Divaricatori costali

FINOCHIETTO

	a	b	c
	mm	mm	mm
57245-13	14	14	120

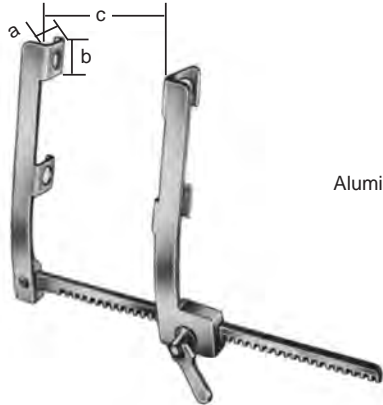

Aluminium

MORSE

	a	b	c
	mm	mm	mm
57246-16	17	22	160

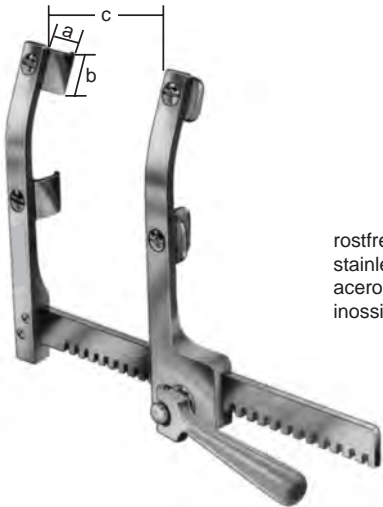

rostfrei  
 stainless  
 acero inoxidable  
 inossidabile

MORSE-FAVALORO

	a	b	c
	mm	mm	mm
57246-21	19	27	210



rostfrei  
 stainless  
 acero inoxidable  
 inossidabile

Rippensperrer  
 Rib Spreaders  
 Separadores costales  
 Divaricatori costali

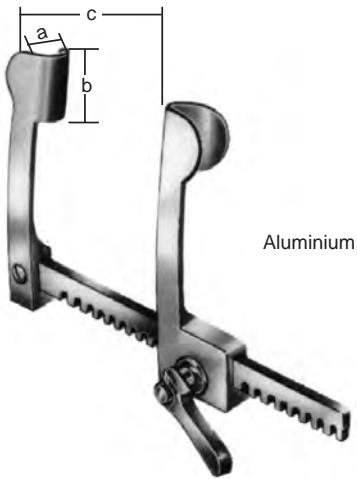

Aluminium

COOLEY-NEONATAL

	a	b	c
	mm	mm	mm
57247-95	12	16	95

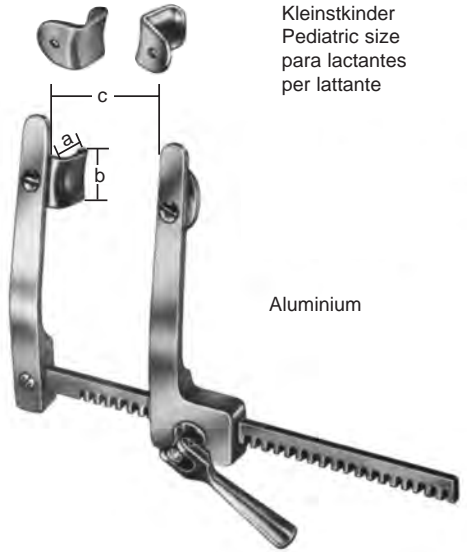

Aluminium

Kleinstkinder  
 Pediatric size  
 para lactantes  
 per lattante

COOLEY

	a	b	c
	mm	mm	mm
57249-01	10	14	90

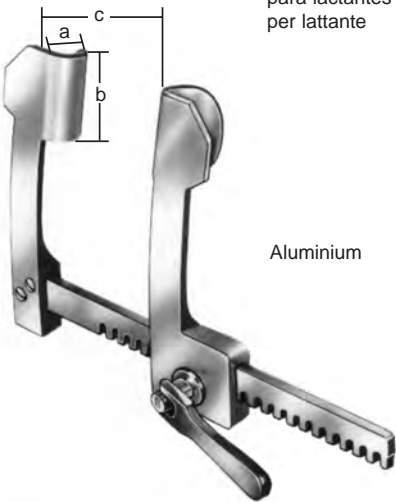

Aluminium

Kleinstkinder  
 Pediatric size  
 para lactantes  
 per lattante

COOLEY

	a	b	c
	mm	mm	mm
57248-14	15	30	140

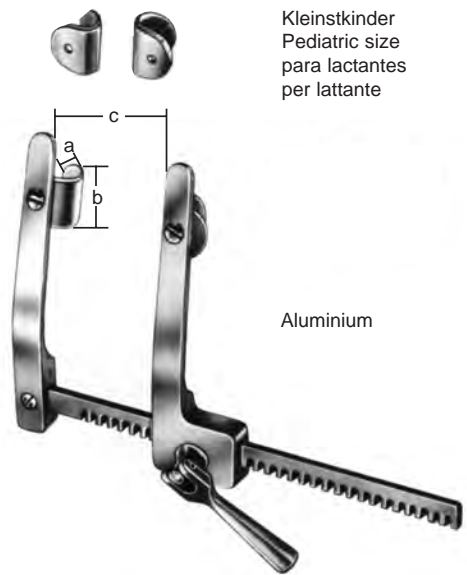

Aluminium

Kleinstkinder  
 Pediatric size  
 para lactantes  
 per lattante

COOLEY

	a	b	c
	mm	mm	mm
57249-02	10	14	90



Rippensperrer rostfrei  
 Rib Spreaders stainless  
 Separadores costales acero inoxidable  
 Divaricatori costali inossidabile

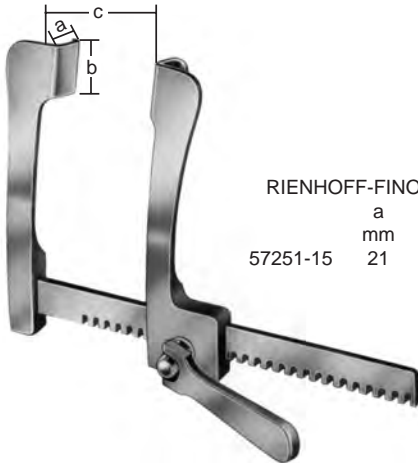

RIENHOFF-FINOCHIETTO

	a	b	c
	mm	mm	mm
57251-15	21	26	150

rostfrei  
 stainless  
 acero inoxidable  
 inossidabile

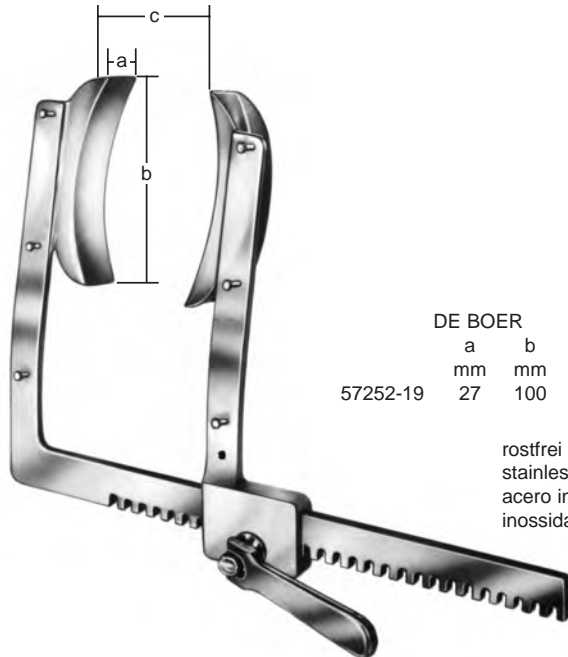

DE BOER

	a	b	c
	mm	mm	mm
57252-19	27	100	190

rostfrei  
 stainless  
 acero inoxidable  
 inossidabile

Rippensperrer rostfrei  
 Rib Spreaders stainless  
 Separadores costales acero inoxidable  
 Divaricatori costali inossidabile

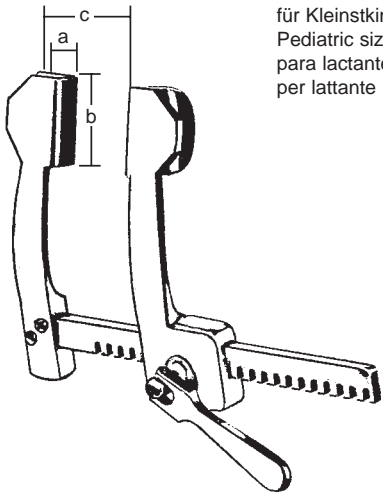

für Kleinstkinder  
 Pediatric size  
 para lactantes  
 per lattante

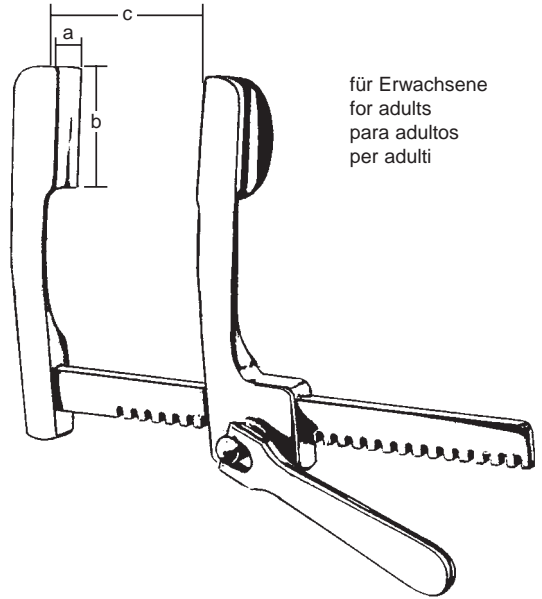

für Erwachsene  
 for adults  
 para adultos  
 per adulti

COOLEY

	a	b	c
	mm	mm	mm
57260-02	16	30	105
57260-03	21	44	150

COOLEY

	a	b	c
	mm	mm	mm
57260-04	37	49	200



HAIGHT

	a	b	c	h
	mm	mm	mm	mm
57260-06	30	30	90	65
57260-09	30	30	90	90



TUFFIER

	a	b	c
	mm	mm	mm
57264-16	50	45	165

Laminektomie-Sperrer  
Laminectomy-Retractor  
Separadores para laminectomía  
Divaricatori Laminectomia

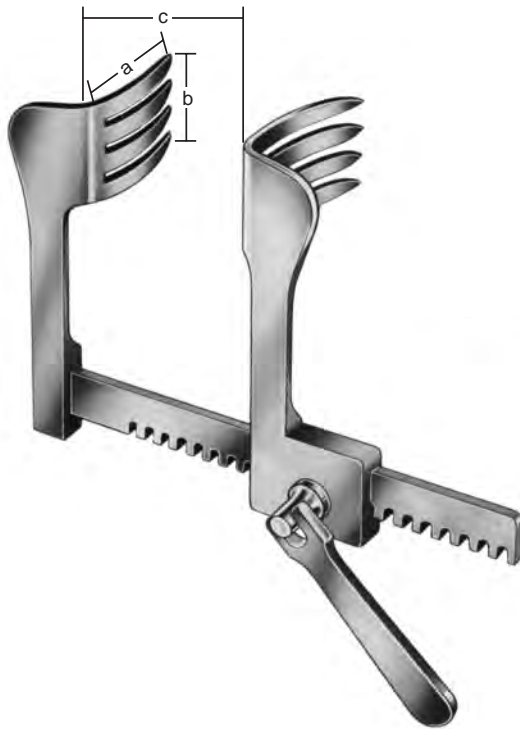

	CHERRY		
	a	b	c
	mm	mm	mm
57266-13	44	70	135

Thoraxsperrer, Rippenkontraktoren, Lungen spatel  
 Thoracic retractor, Rib Contractors, Lung Spatulas  
 Separador torácico, Aproximadores para costillas, Espátulas pulmonares  
 Divaricatore per il torace, Approssimatori costali, Spatole per polmone



MERCEDES compl.  
 57270-00

57270-80  
 Sperrer allein  
 Retractor only  
 Separador solo  
 Divaricatore solo

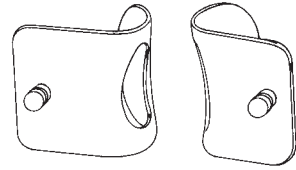

57270-65  
 42x65 mm

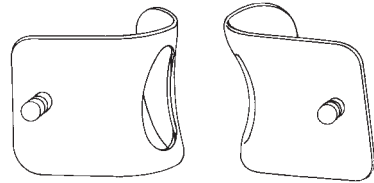

57270-75  
 75x75 mm

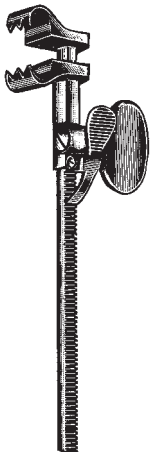

BAILEY-BABY  
 57283-14  
 14 cm, 5 1/2"

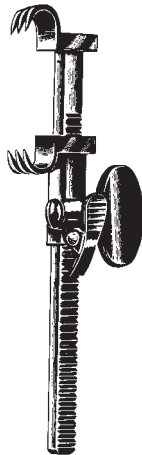

BAILEY  
 57284-16  
 16 cm, 6 1/4"



BAILEY-GIBBON  
 57286-16  
 16 cm, 6 1/4"



57288-30  
 30 cm, 11 3/4"



ALLISON  
 57289-32  
 32 cm, 12 3/4"

Lungenfaßzange, Bronchusklemmen  
 Lung Grasping Forceps, Bronchus Forceps  
 Pinzas para coger el pulmón, Pinzas clamps bronquiales  
 Pinze per afferrare il pulmone, Pinze per bronchi

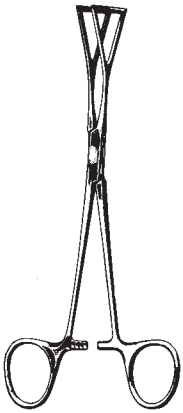

LOVELACE  
 57290-20  
 20 cm, 8"

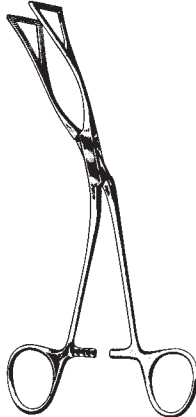

LOVELACE  
 57291-20  
 20 cm, 8"



HARRINGTON  
 57301-30  
 30,5 cm, 12"

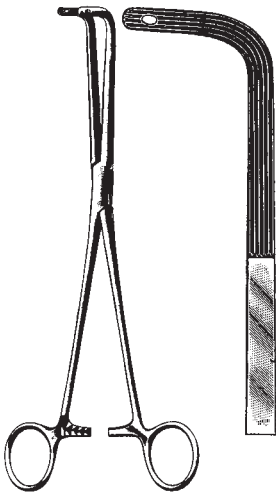

FINOCIETTO  
 57307-24  
 24 cm, 9 1/2"

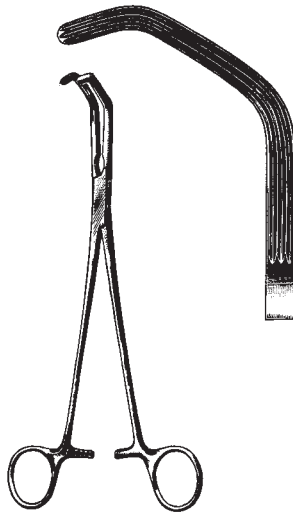

PRICE-THOMAS  
 57309-22  
 22 cm, 8 3/4"

Zähne links  
 tooth left  
 dientes izquierda  
 denti sinistro  
 57311-22



PRICE-THOMAS  
 22 cm, 8 3/4"

rechts  
 right  
 derecha  
 destro  
 57313-22

Bronchusklemmen, Gefäßklemmen  
 Bronchus Forceps, Blood Vessel Clamps  
 Pinzas clamps bronquiales, Pinzas-clamps para vasos  
 Pinze per bronchi, Pinze cardiovascolari



57321-23

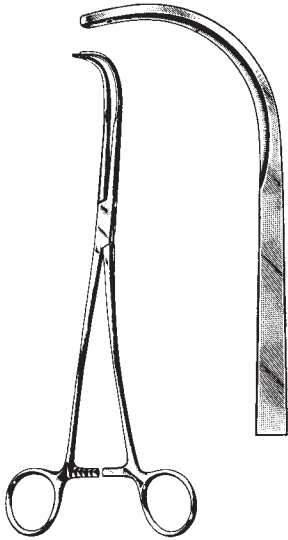

SEMB  
 23 cm, 9"

57323-23

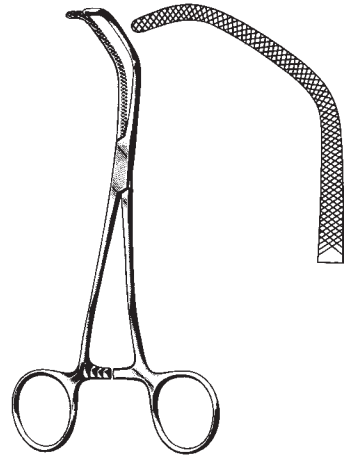

SATINSKY  
 57325-15  
 15 cm, 6"

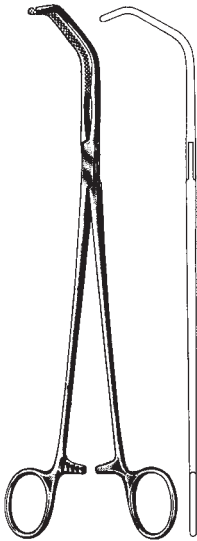

SATINSKY  
 57327-26 - 57329-26  
 26 cm, 10 1/4"

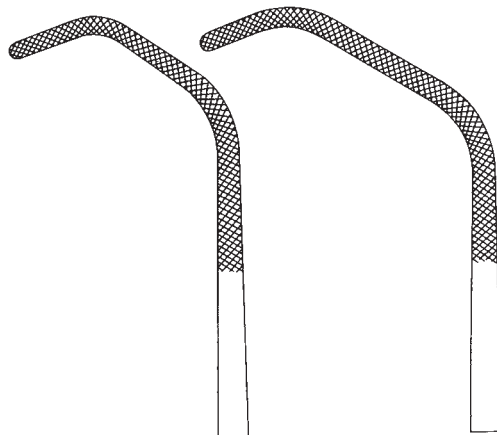
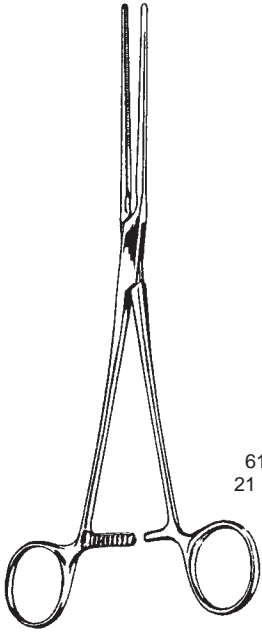

Fig. 1 57327-26

Fig. 2 57329-26

Coarctations-Klemmen  
 Coarctation clamps  
 Pinzas clamps para coartación  
 Pinza per coartazione



POTTS  
 61000-21 - 61000-22

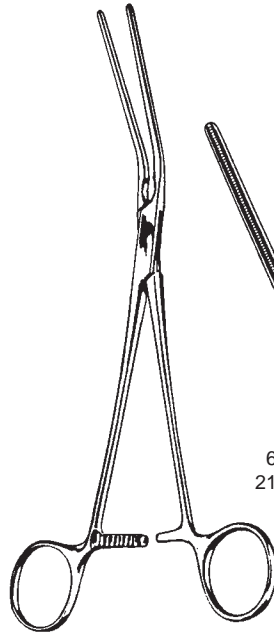
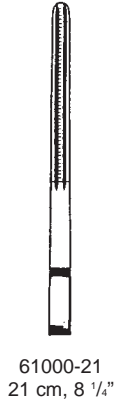

POTTS  
 61001-21 - 61001-22

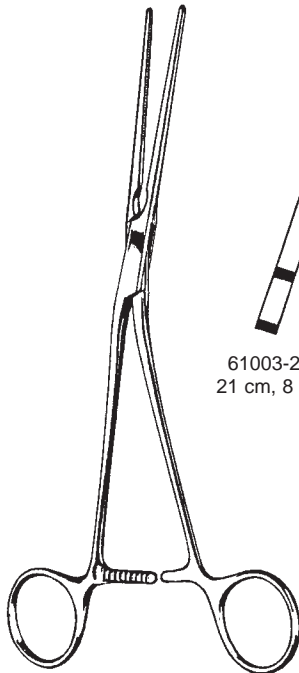
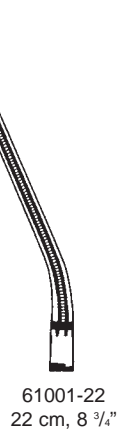
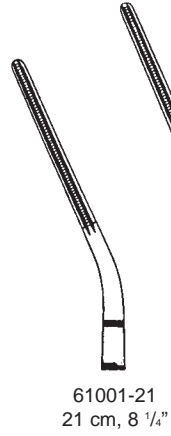

POTTS  
 61003-21 - 61003-22



Anastomosens-Klemmen, Präparier- und Ligaturklemmen  
 Anastomosis clamps, Dissecting and ligature forceps  
 Pinzas clamps para anastomosis, Pinzas para preparaciones y ligaduras  
 Pinze per anastomosi, Pinze per preparazioni e legature

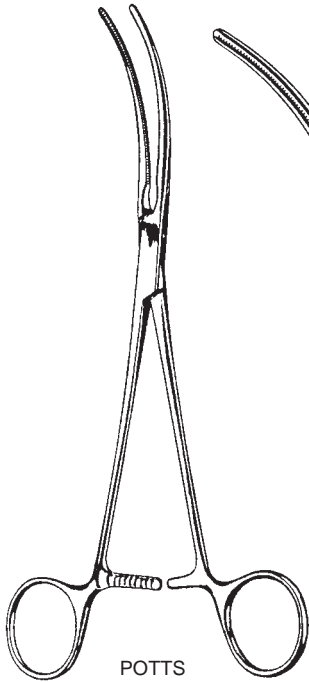

POTTS  
 61005-22  
 22 cm, 8 3/4"

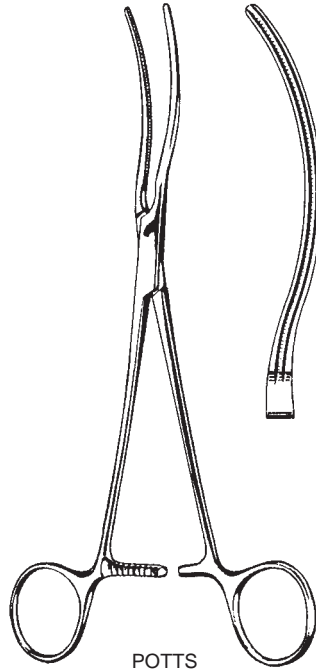

POTTS  
 61007-22  
 22 cm, 8 3/4"

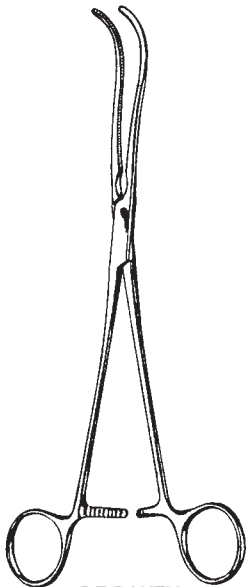

DE BAKEY  
 61008-19 - 61008-23



61008-19  
 19 cm, 7 1/2"



61008-23  
 23 cm, 9"



Peripheral-Gefäßklemmen  
 Peripheral vascular clamps  
 Pinzas-clamps para vasos periféricos  
 Pinze vascolari periferici

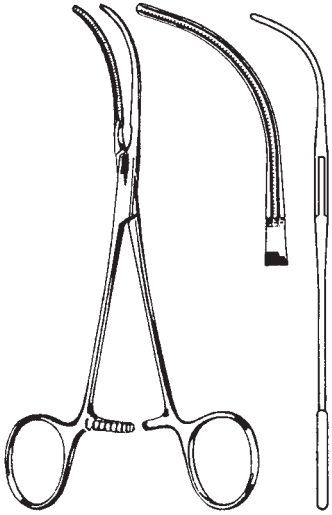

DE BAKEY  
 61009-16  
 16 cm, 6 1/4"

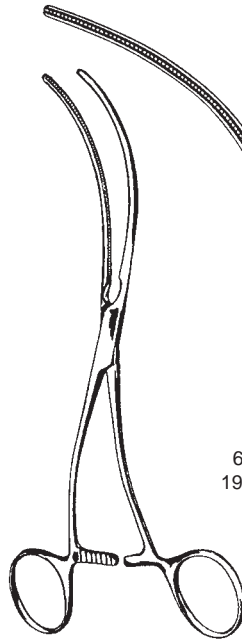

61011-19  
 19 cm, 7 1/2"

DE BAKEY  
 61011-19 - 61011-20

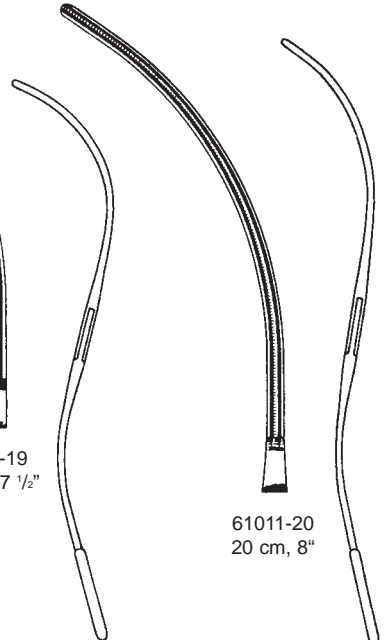

61011-20  
 20 cm, 8"



LELAND-JONES  
 61013-18 - 61013-20

61013-18  
 18 cm, 7"



61013-19  
 19 cm, 7 1/2"

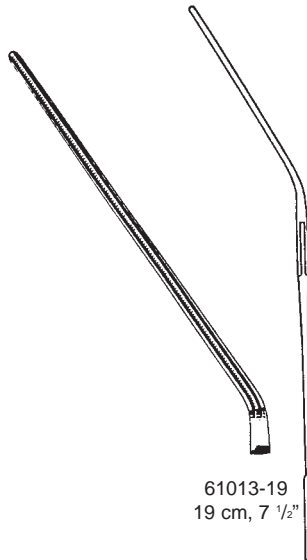

61013-20  
 20 cm, 8"

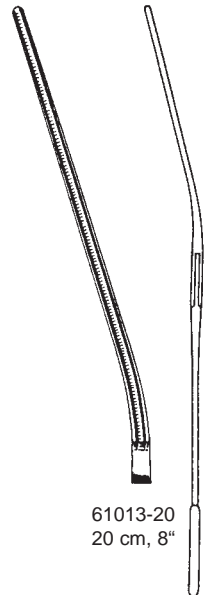

Mehrzweck-Gefäßklemme  
 Multi purpose Vascular Clamps  
 Pinzas vasculares de usos multiples  
 Pinze vascolari universali

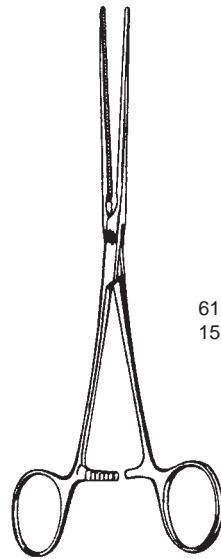

61014-15  
 15 cm, 6"

61014-18  
 18 cm, 7"

BAINBRIDGE  
 61014-15 - 61014-18

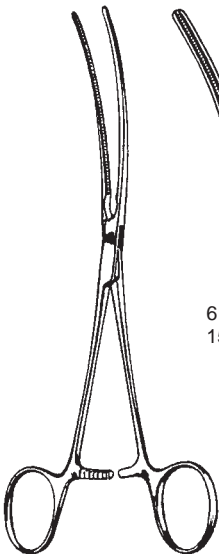

61015-15  
 15 cm, 6"

61015-18  
 18 cm, 7"

BAINBRIDGE  
 61015-15 - 61015-18

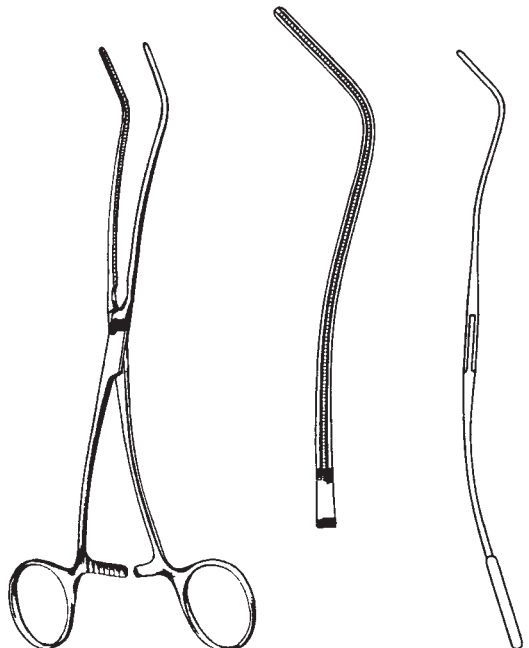

DE BAKEY  
 61016-20  
 20 cm, 8"

Aorta-Aneurysmaklemmen  
Aortic aneurysm clamps  
Pinzas-clamps para aneurisma de la aorta  
Pinze per aneurisma aorta



61017-26  
26 cm, 10 1/4"

61017-27  
27 cm, 10 1/2"

61017-31  
31 cm, 12 1/4"

61017-33  
33 cm, 13"

DE BAKKEY  
61017-26 - 61017-33

Aorta-Aneurysmaklemmen  
Aortic aneurysm clamps  
Pinzas-clamps para aneurisma de la aorta  
Pinze per aneurisma aorta



DE BAKEY  
61018-28  
28 cm, 11"

Aorta-Aneurysmaklemmen  
Aortic aneurysm clamps  
Pinzas-clamps para aneurisma de la aorta  
Pinze per aneurisma aorta

Draufsicht  
Top view  
Vista de arriba  
Vista da vicino

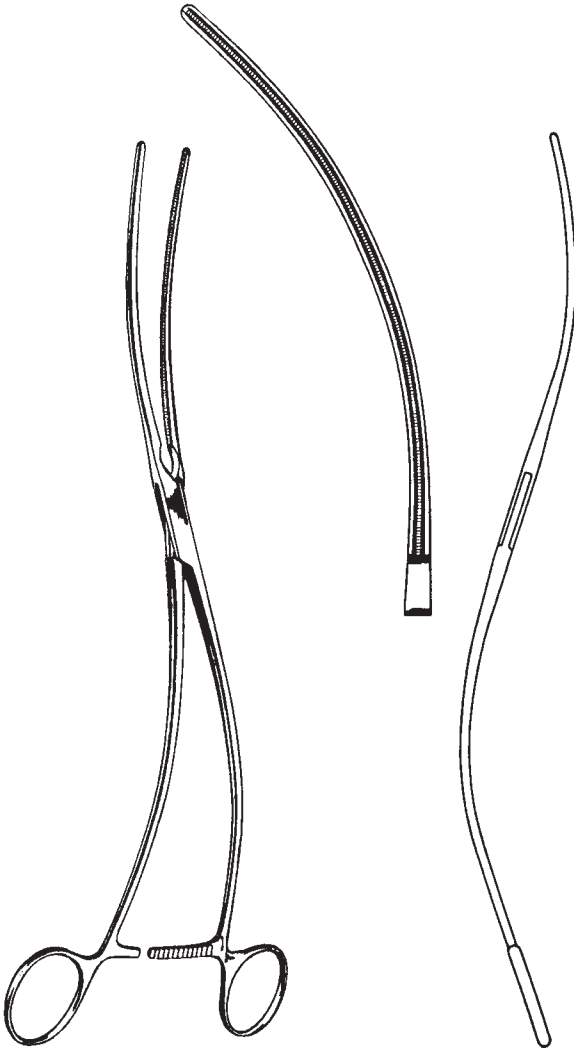

DE BAKEY  
61019-30  
30 cm, 11 3/4"

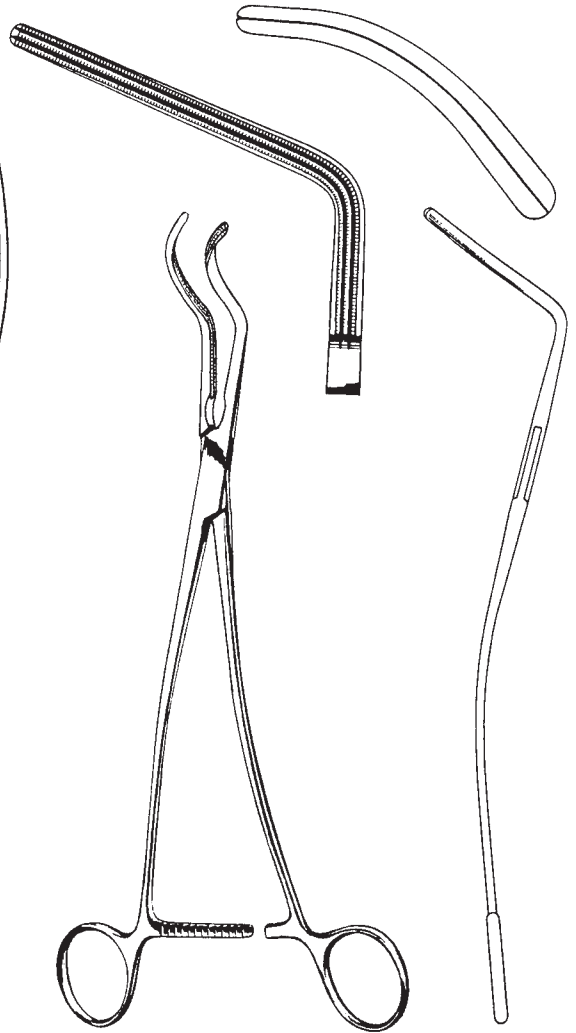

DE BAKEY  
61020-27  
27 cm, 10 1/2"

Ligaturklemmen, Aortaklemme  
Ligature clamps, Aortic clamp  
Pinzas clamps para ligaduras y la aorta  
Pinze per legature e aorta

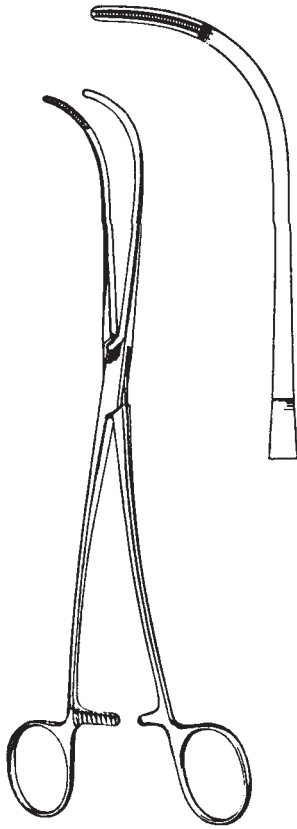

DE BAKEY-SEMB  
61021-24  
24 cm, 9 1/2"

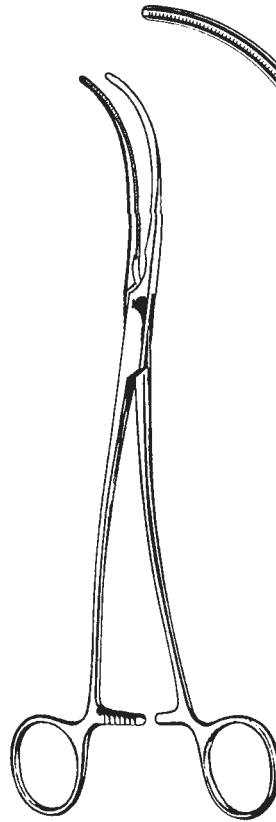

DE BAKEY  
61022-24  
24 cm, 9 1/2"



Ligaturklemme, Aortaklemme  
Ligature clamp, Aortic clamp  
Pinzas clamps para ligaduras y la aorta  
Pinze per legature e aorta

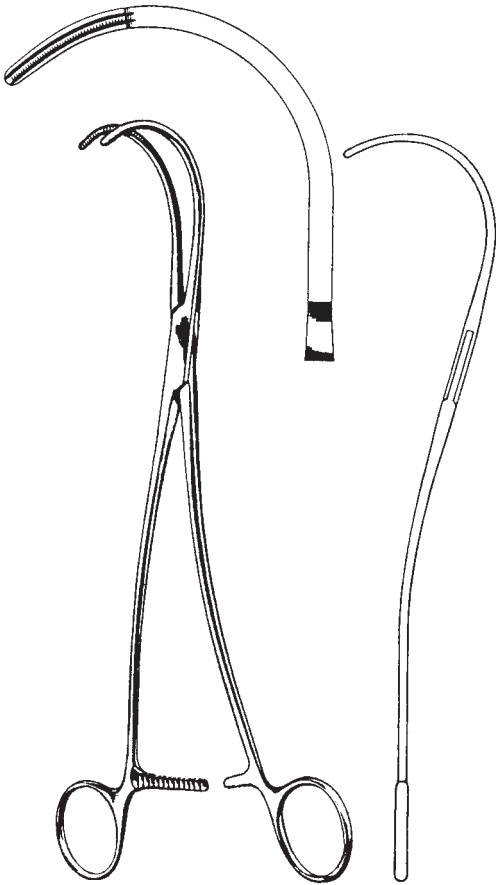

DE BAKEY  
61023-25  
25 cm, 10"

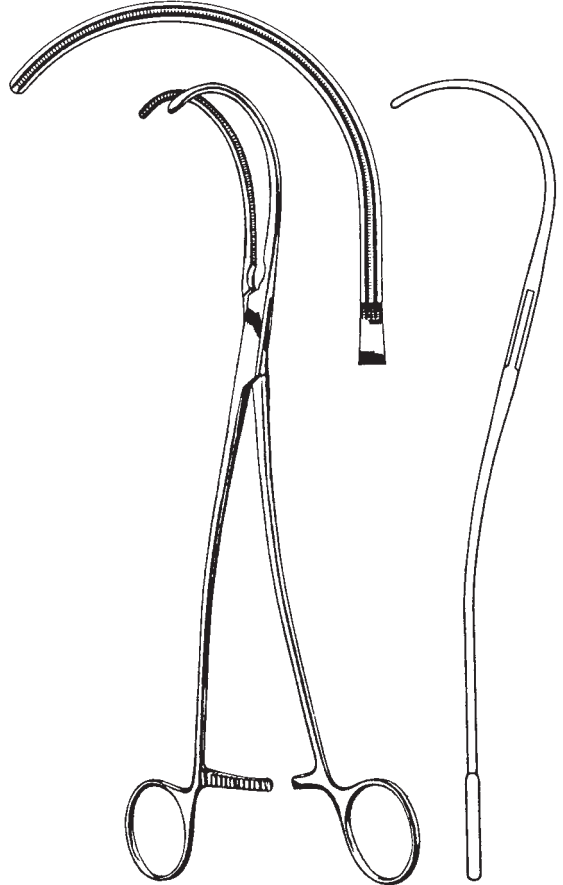

DE BAKEY  
61023-26  
26 cm, 10 1/4"

Aortaklemmen  
Aortic clamps  
Pinzas-clamps para la aorta  
Pinze per aorta

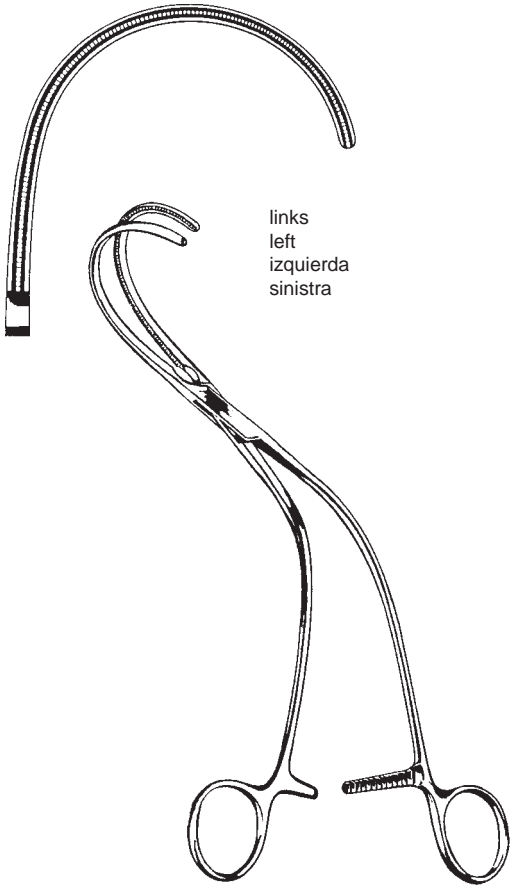

WEBER  
61024-01  
26 cm, 10 1/4"

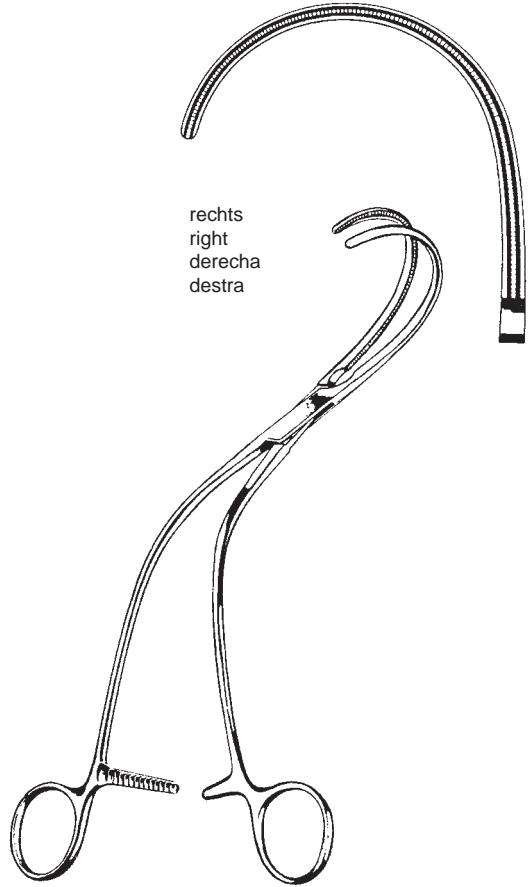

WEBER  
61024-02  
26 cm, 10 1/4"



Tangentialklemmen  
Tangential occlusion clamps  
Pinzas-clamps para oclusión tangencial  
Pinze per occlusione tangenziale

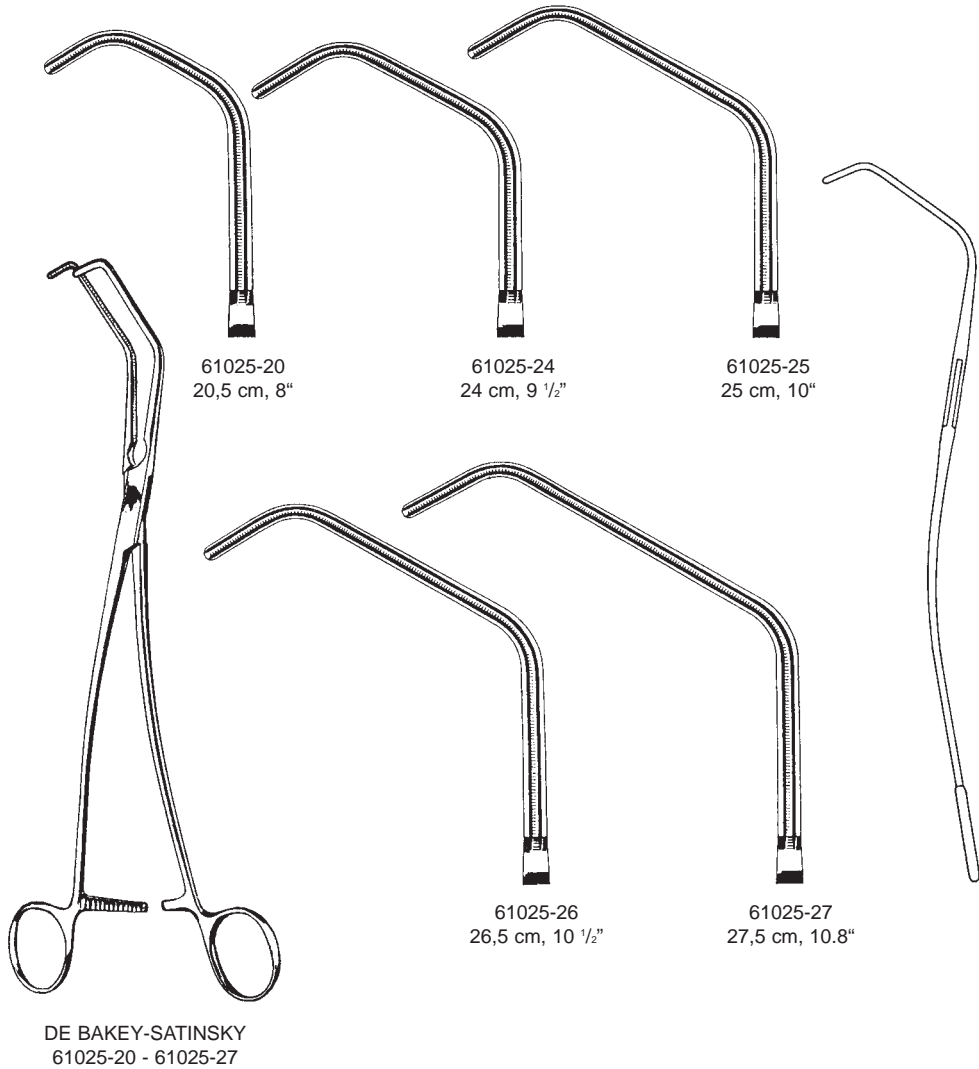

Aurikelklemmen  
Auricle clamps  
Pinza-clamps auriculares  
Pinza auricula



HARKEN  
61026-01 - 61026-04

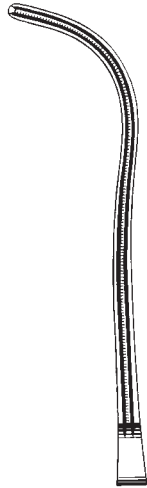

61026-01  
24 cm, 9 1/2"

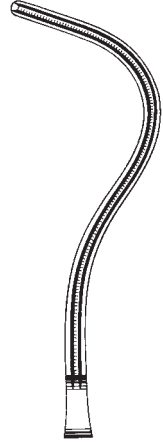

61026-02  
24 cm, 9 1/2"

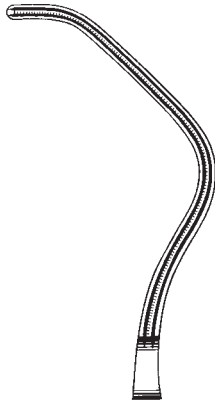

61026-03  
24 cm, 9 1/2"

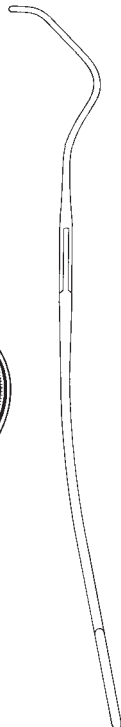

61026-04  
24 cm, 9 1/2"

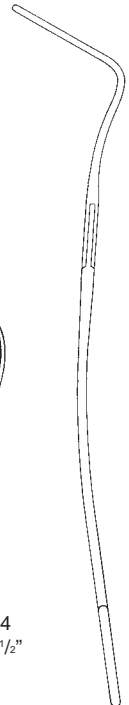

Bronchusklemmen  
Bronchus clamp  
Pinzas-clamps bronquiales  
Pinze per bronchi

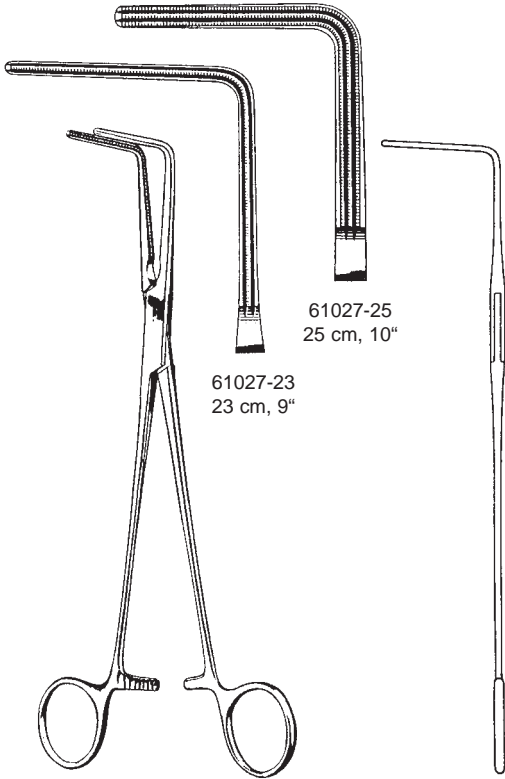

LEES  
61027-23 - 61027-25

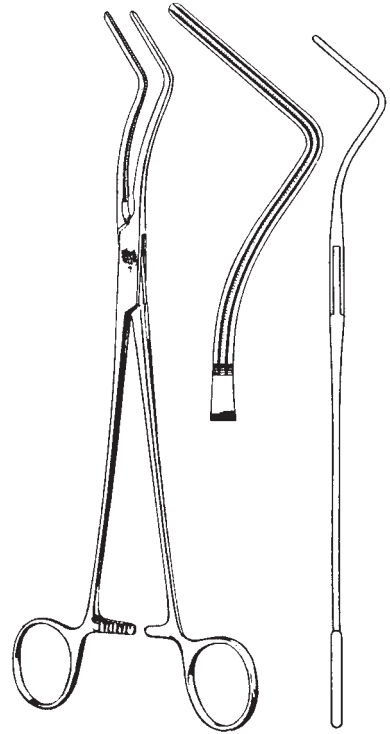

LEES  
61029-25  
25 cm, 10"

Aorta-Anastomosenklemmen  
Aortic anastomosis clamps  
Pinzas-clamps para anastomosis  
Pinze anastomosi aorta

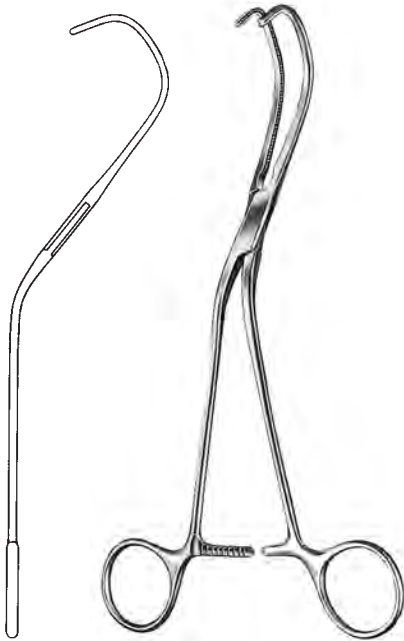

LAMBERT-KAY  
21 cm, 8 1/4"  
61030-21 - 61030-22



61030-22

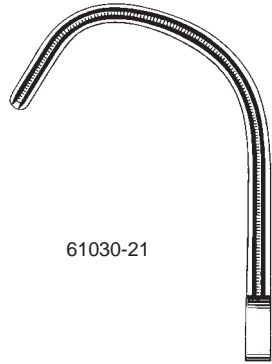

61030-21



DE BAKEY  
61031-17  
17 cm, 6 3/4"

Aorta - und Aneurysmaklemme  
 Aortic- and Aneurysm clamps  
 Pinzas aórticas y para aneurisma  
 Pinze per aorta e per aneurisma

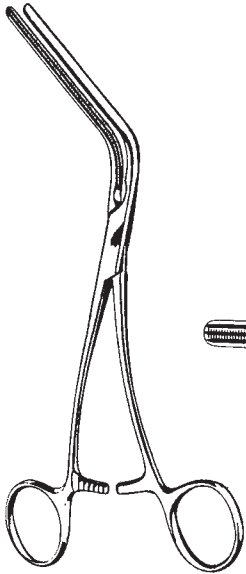

MORRIS-DE BAKLEY  
 61032-18 - 61032-25

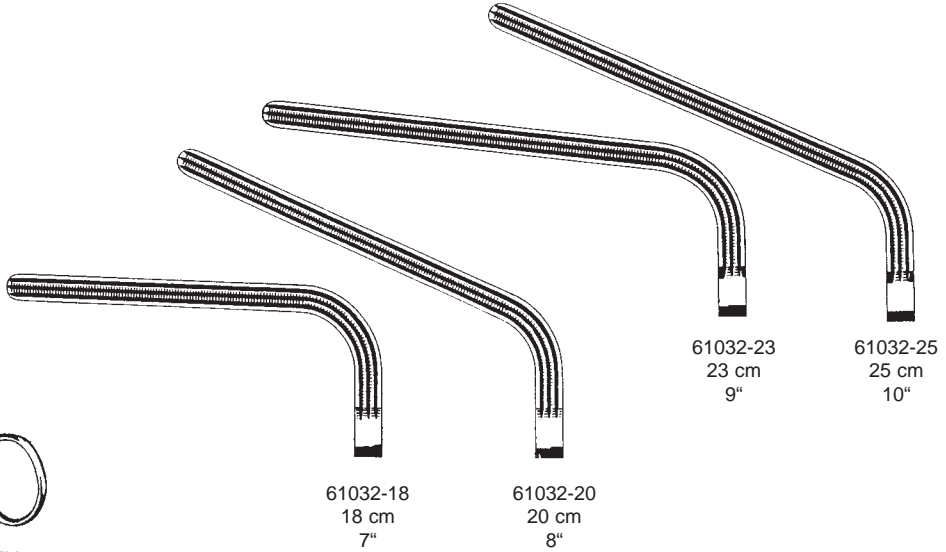

61032-18  
 18 cm  
 7"

61032-20  
 20 cm  
 8"

61032-23  
 23 cm  
 9"

61032-25  
 25 cm  
 10"

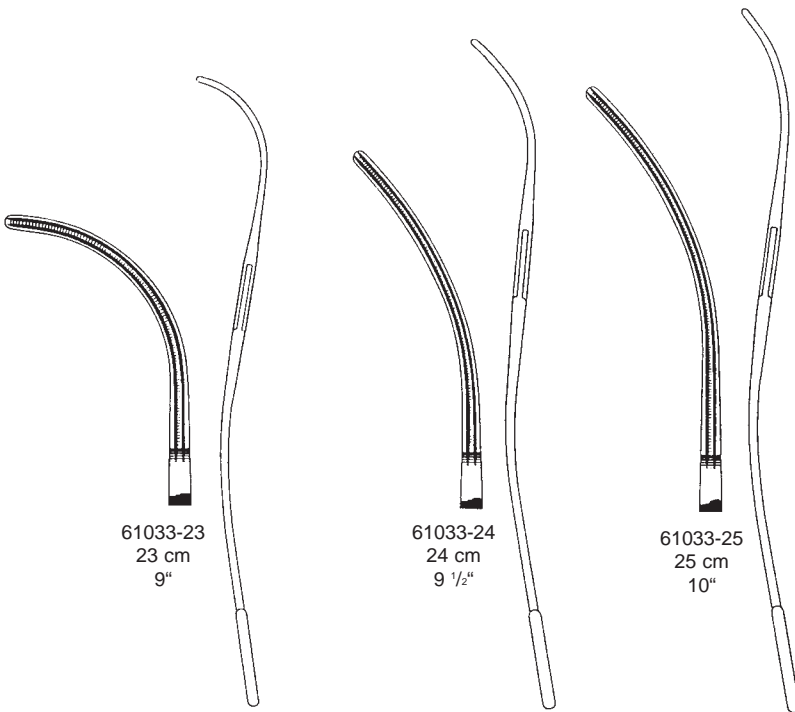

61033-23  
 23 cm  
 9"

61033-24  
 24 cm  
 9 1/2"

61033-25  
 25 cm  
 10"

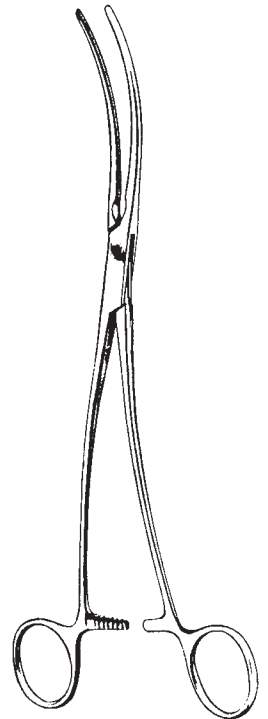

DE BAKLEY-BAHNSON  
 61033-23 - 61033-25

Coarctations-Klemmen  
 Coarctation clamps  
 Pinzas-clamps para coartación  
 Pinze per coartazione

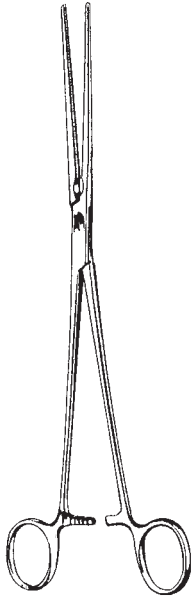

DE BAKEY  
 61034-21 - 61034-31



61034-21  
 21,5 cm  
 8 1/2"



61034-23  
 23 cm  
 9"



61034-27  
 27 cm  
 10 1/2"



61034-31  
 31,5 cm  
 12 1/2"

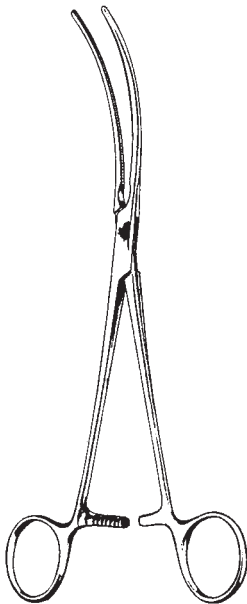

DE BAKEY  
 61035-21 - 61035-31

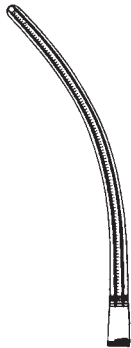

61035-21  
 21,5 cm  
 8 1/2"



61035-23  
 23 cm  
 9"

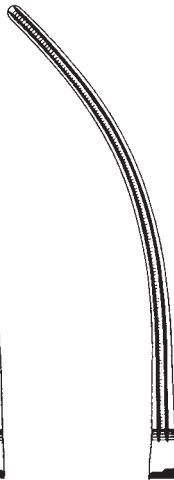

61035-27  
 27 cm  
 10 1/2"

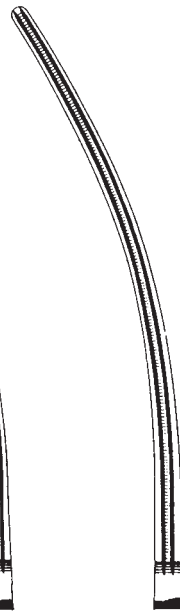

61035-31  
 31 cm  
 12 1/4"

Mehrzweckklemmen  
 Multi purpose clamps  
 Pinzas-clamps para usos varios  
 Pinze per usi multipli

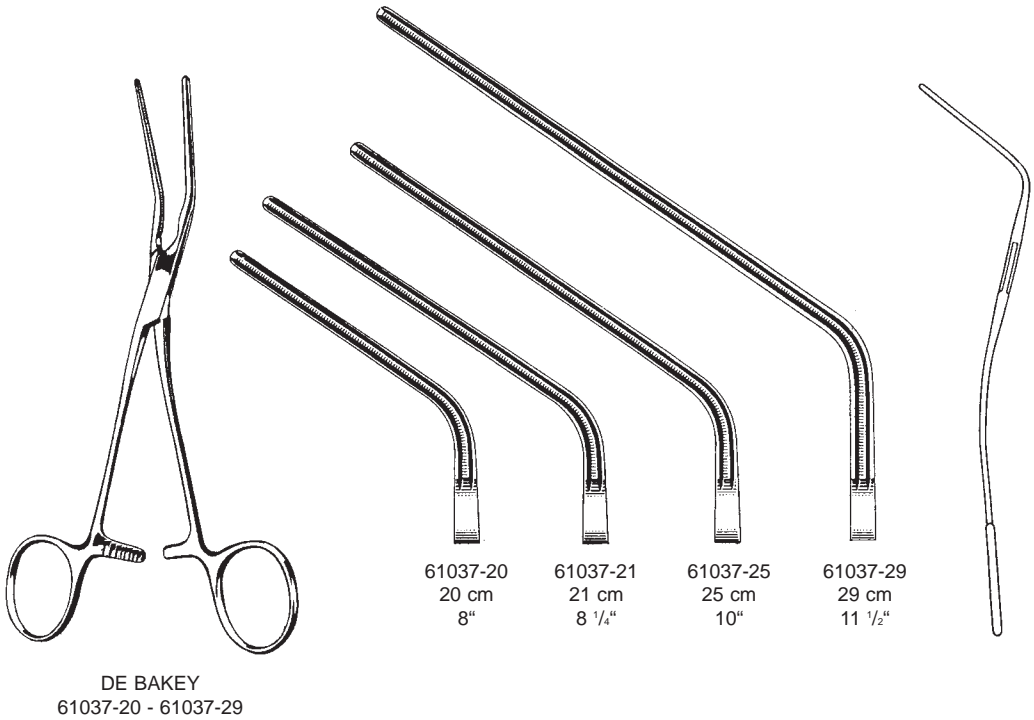
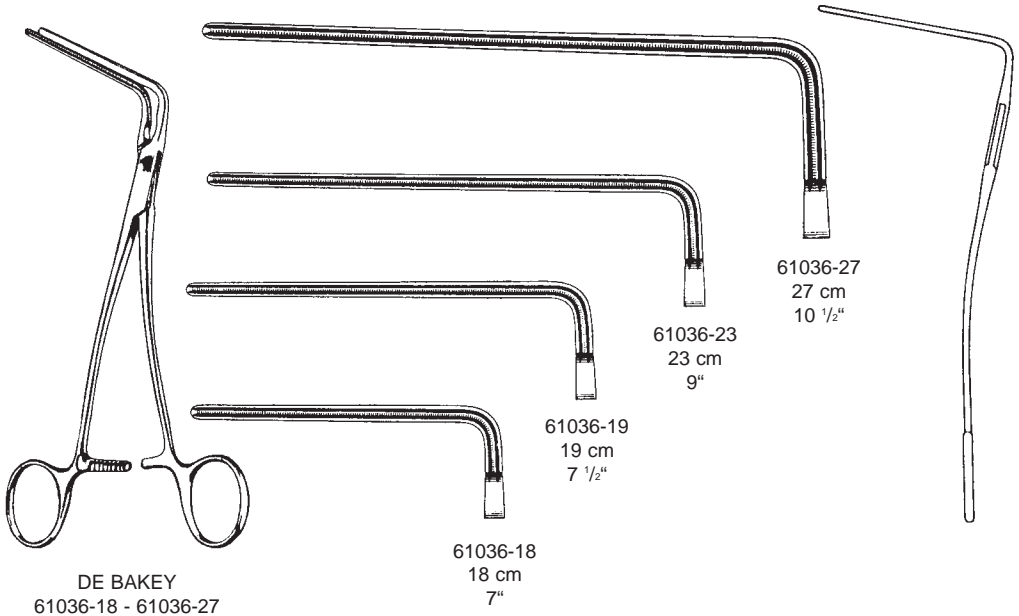

Atrauma-Arterienklemmen  
Atrauma hemostatic forceps  
Pinzas hemostáticas atraumáticas  
Pinze emostatiche Atrauma

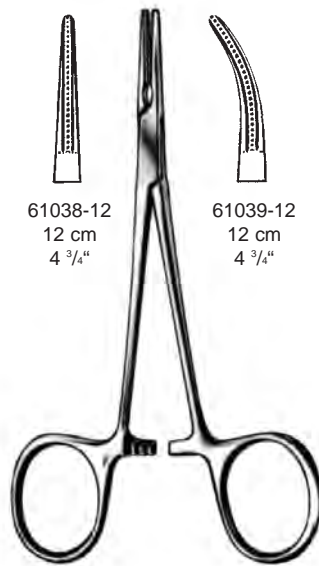

61038-12  
12 cm  
4 <sup>3</sup>/<sub>4</sub>"

61039-12  
12 cm  
4 <sup>3</sup>/<sub>4</sub>"

DE BAKEY-MOSQUITO  
61038-12 - 61039-12



Aortaklemme, Katheterklemme  
 Aortic clamps, Catheter clamps  
 Pinzas-clamps para aorta, Pinzas para catéteres  
 Pinze per aorta, Pinze per cateteri

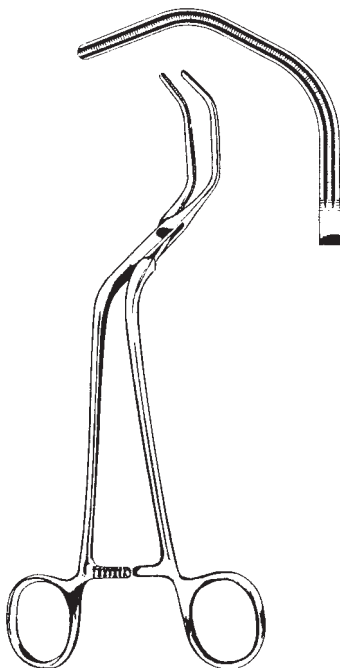

DIETRICH  
 61040-21 21 cm, 8 1/4"

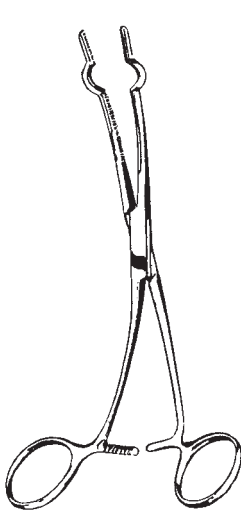

COOLEY  
 61050-01 - 61050-07

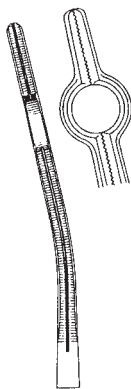

Charrière (French)	Länge Length Largo Lungo cm		
24	16	6 1/4"	61050-01
26	16	6 1/4"	61050-02
28	20	8"	61050-03
30	20	8"	61050-04
32	20	8"	61050-05
36	20	8"	61050-07

61050-01 - 61050-02  
 für Kinder  
 for children  
 para niños  
 per bambini

61050-03 - 61050-07  
 für Erwachsene  
 for adults  
 para adultos  
 per adulti

Carotis-Shuntklemmen  
Carotid Shunt Clamps  
Pinzas para shunt carótido  
Pinze per carotide



JAVID  
61045-18  
17,5 cm, 6.9"



JAVID  
61046-19  
18 cm, 7"

Atrauma Cardiovascular-Klemmen  
Atrauma Cardiovascular Forceps  
Pinzas-clamps cardiovasculares  
Pinze per chirurgia vascolare

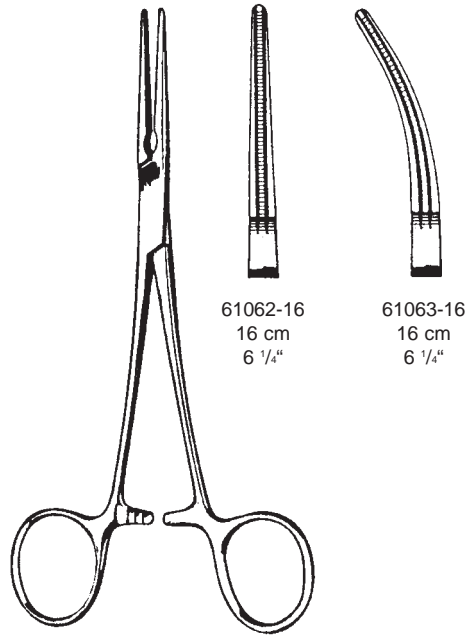



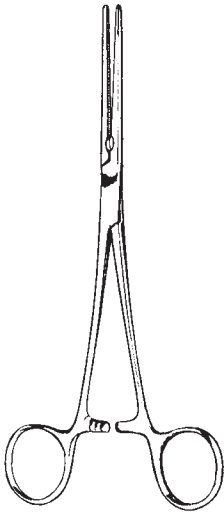

DE BAKEY-RANKIN  
61062-16 - 61063-16

Atrauma Cardiovascular-Klemmen  
 Atrauma Cardiovascular Forceps  
 Pinzas-clamps cardiovasculares  
 Pinze per chirurgia vascolare





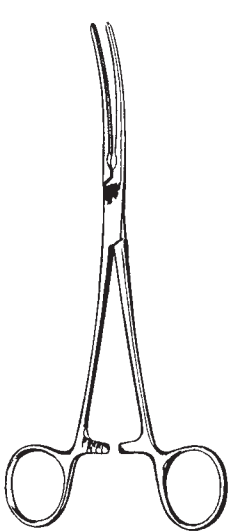

DE BAKEY-PEAN  
 61138-14 - 61138-20

			
61138-14 14 cm 5 1/2"	61138-16 16 cm 6 1/4"	61138-18 18 cm 7"	61138-20 20 cm 8"



DE BAKEY-PEAN  
 61139-14 - 61139-20

			
61139-14 14 cm 5 1/2"	61139-16 16 cm 6 1/4"	61139-18 18 cm 7"	61139-20 20 cm 8"

Atrauma Cardiovascular-Klemmen  
 Atrauma Cardiovascular Forceps  
 Pinzas-clamps cardiovasculares  
 Pinze per chirurgia vascolare

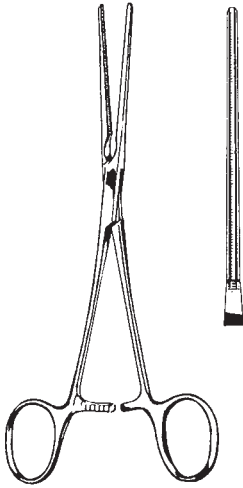

DE BAKEY  
 61140-17  
 17 cm, 6 3/4"

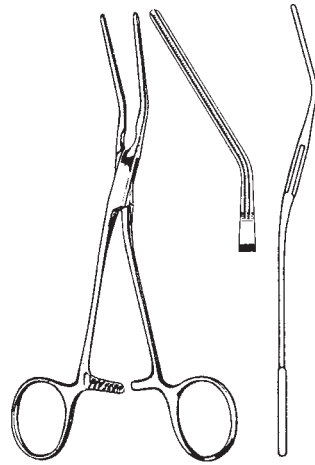

DE BAKEY  
 61141-16  
 16 cm, 6 1/4"

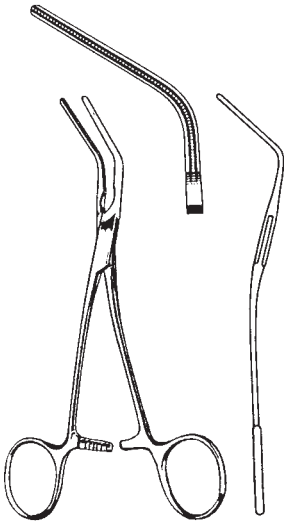

DE BAKEY  
 61143-15  
 15 cm, 6"

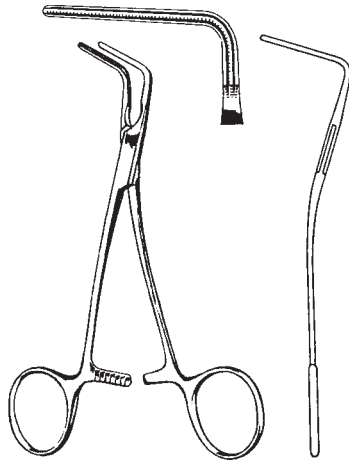

DE BAKEY  
 61145-15  
 15 cm, 6"

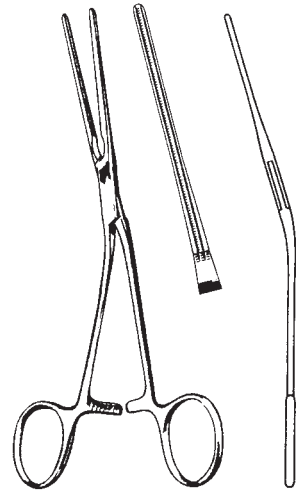

DE BAKEY  
 61147-17  
 17 cm, 6 3/4"

Atrauma Cardiovascular-Klemmen  
 Atrauma Cardiovascular Forceps  
 Pinzas-clamps cardiovasculares atraumáticas  
 Pinze cardiovascolari atraumatiche

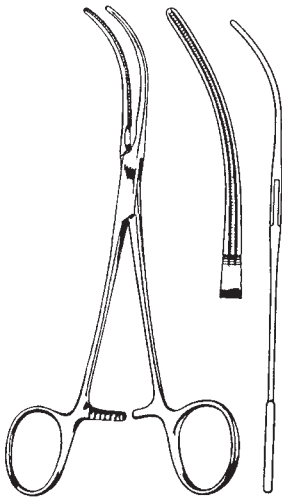

GLOVER  
 61149-17  
 17 cm, 6 3/4"

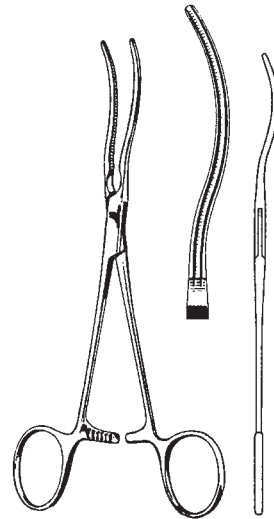

DE BAKEY  
 61151-17  
 17 cm, 6 3/4"

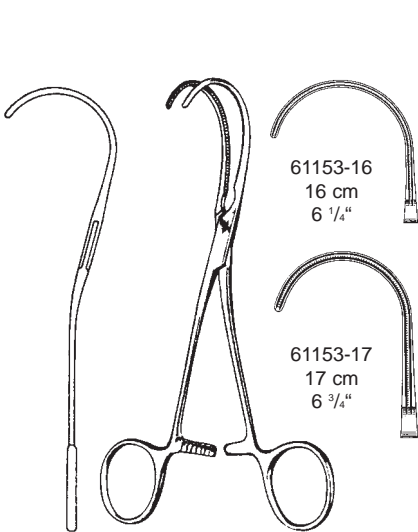

61153-16  
 16 cm  
 6 1/4"

61153-17  
 17 cm  
 6 3/4"

DE BAKEY  
 61153-16 - 61153-17

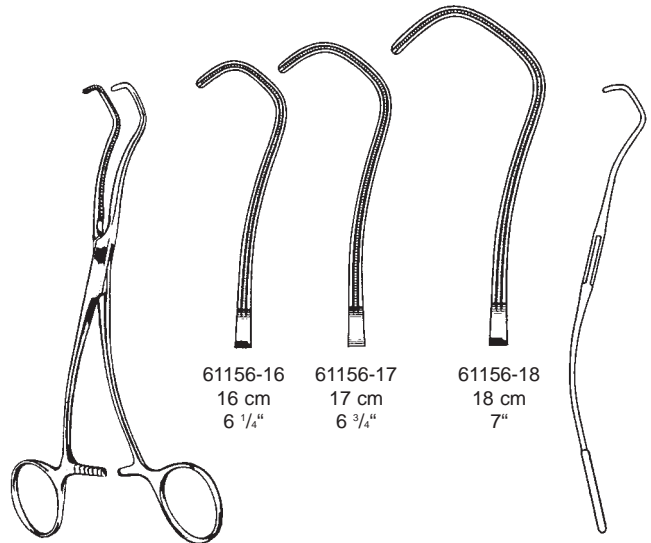

61156-16  
 16 cm  
 6 1/4"

61156-17  
 17 cm  
 6 3/4"

61156-18  
 18 cm  
 7"

DERRA  
 61156-16 - 61156-18

Atrauma Cardiovascular-Klemmen  
Atrauma Cardiovascular Forceps  
Pinzas-clamps cardiovasculares atraumáticas  
Pinze atraumatiche per chirurgia vascolare

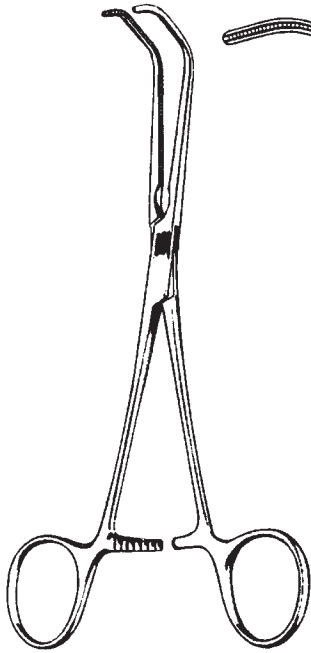

BECK  
61157-17 17 cm, 6 <sup>3</sup>/<sub>4</sub>"

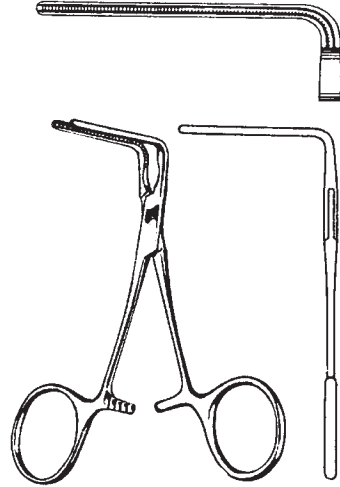

DE BAKEY  
61158-10 10 cm, 4"

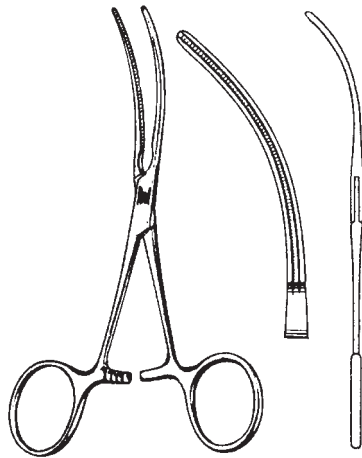

DE BAKEY  
61158-11 11 cm, 4 <sup>3</sup>/<sub>8</sub>"

Atrauma Cardiovascular-Klemmen  
 Atrauma Cardiovascular Forceps  
 Pinzas-clamps cardiovasculares atraumáticas  
 Pinze atraumatiche per chirurgia vascolare

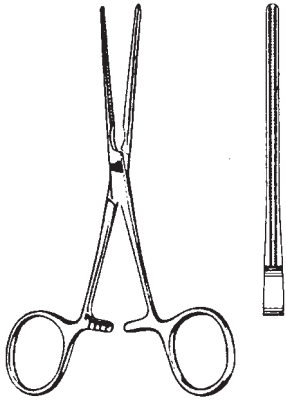

DE BAKEY  
 61158-12 12 cm, 4 3/4"

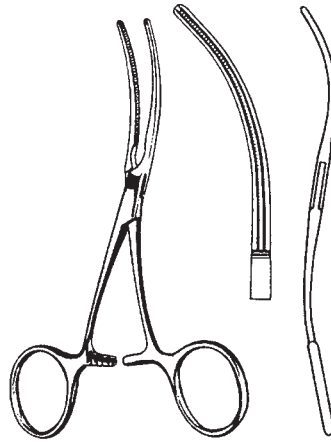

DE BAKEY  
 61159-12 11,5 cm, 4 1/2"

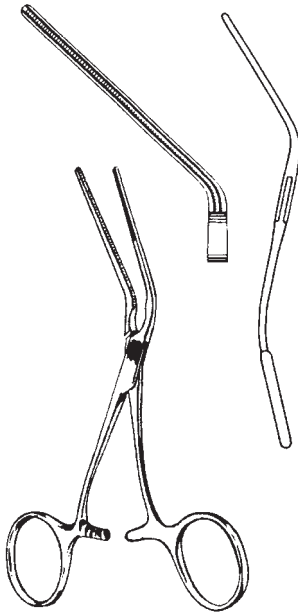

DE BAKEY  
 61159-13 13 cm, 5 1/8"

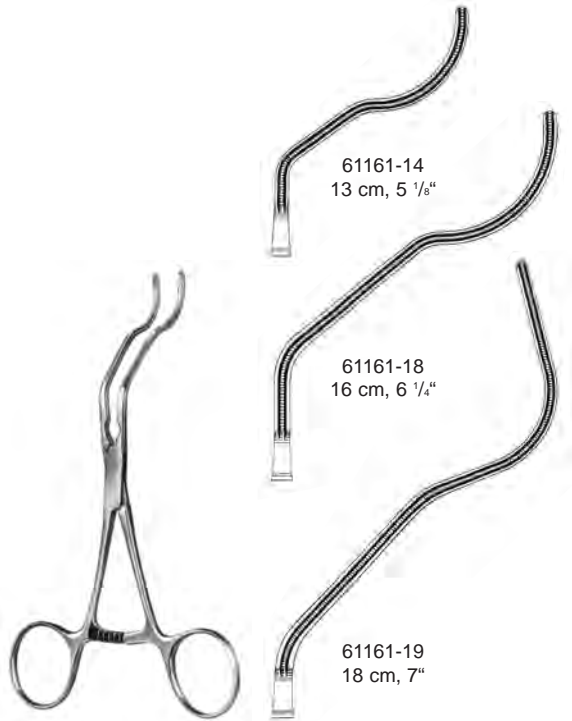

GREGORY

61161-14  
 13 cm, 5 1/8"

61161-18  
 16 cm, 6 1/4"

61161-19  
 18 cm, 7"



Atrauma Cardiovascular-Klemmen  
 Atrauma Cardiovascular Forceps  
 Pinzas-clamps cardiovasculares atraumáticas  
 Pinze atraumatiche per chirurgia vascolare

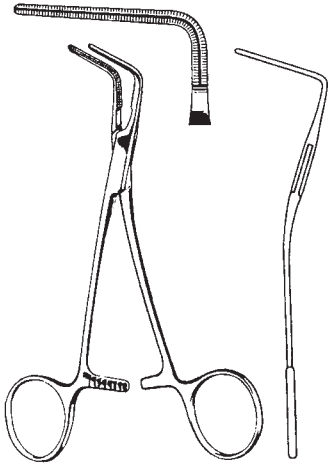

COOLEY  
 61172-15  
 15 cm, 6"

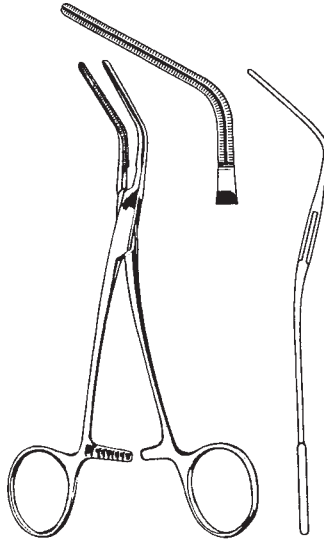

COOLEY  
 61173-16  
 15,5 cm, 6"

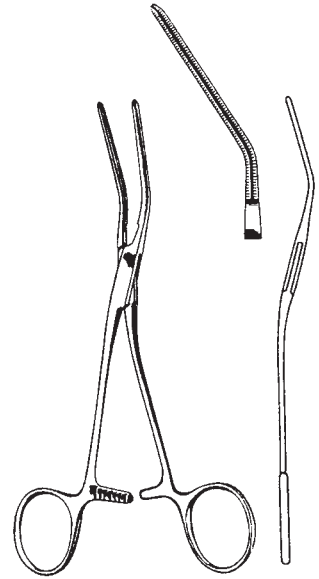

COOLEY  
 61174-17  
 17 cm, 6 3/4"

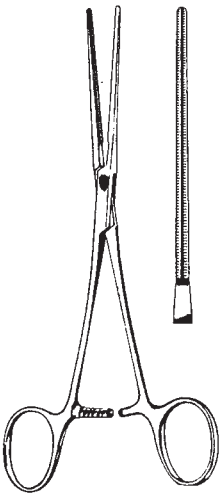

COOLEY  
 61175-17  
 17 cm, 6 3/4"

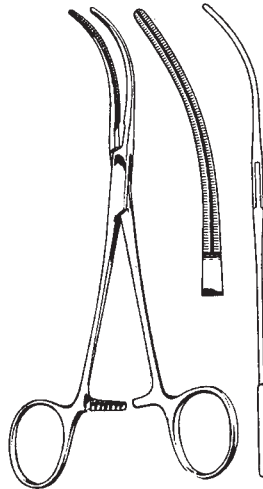

COOLEY  
 61176-17  
 17 cm, 6 3/4"

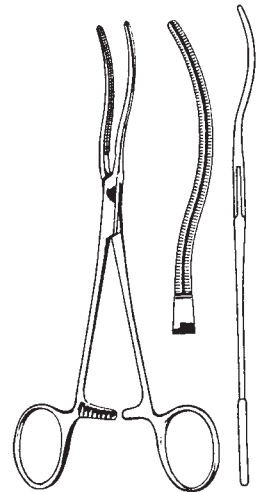

COOLEY  
 61177-17  
 17 cm, 6 3/4"

Atrauma Cardiovascular-Klemmen  
 Atrauma Cardiovascular Forceps  
 Pinzas-clamps cardiovasculares atraumáticas  
 Pinze atraumatiche per chirurgia vascolare

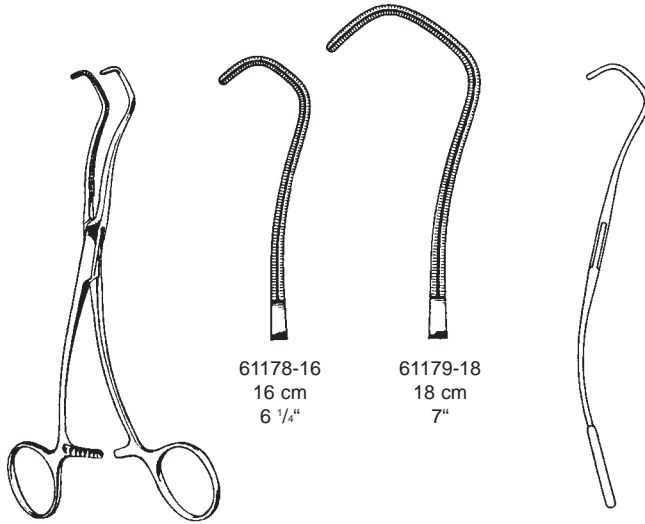

61178-16  
 16 cm  
 6 1/4"

61179-18  
 18 cm  
 7"

COOLEY-DERRA  
 61178-16 - 61179-18

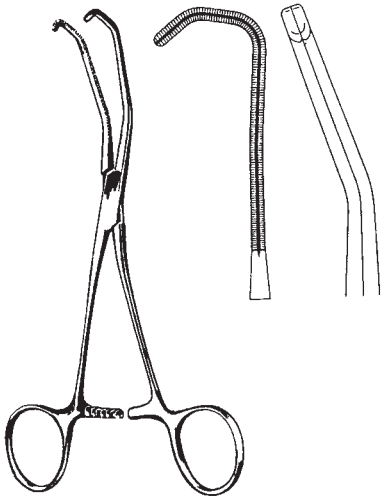

COOLEY  
 61180-17  
 17 cm, 6 3/4"

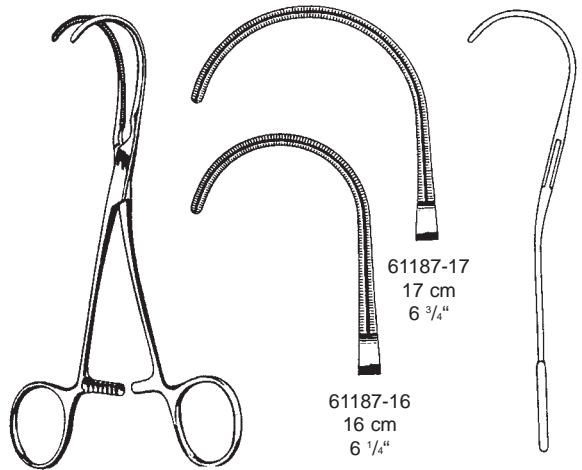

61187-17  
 17 cm  
 6 3/4"

61187-16  
 16 cm  
 6 1/4"

COOLEY  
 61187-16 - 61187-17

Anastomosenklemmen, Mehrzweck-Gefäßklemme  
 Anastomosis clamp, Multi purpose Vascular Clamps  
 Pinza clamp para iliac y anastomosis, Pinzas vasculares de usos multiples  
 Pinze anastomosi, Pinze vascolari universali

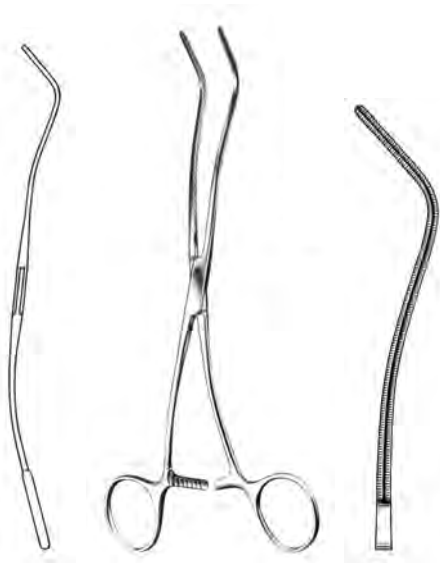

COOLEY  
 61188-20 20 cm, 8"



COOLEY  
 61189-21 21 cm, 8 1/4"



BECK  
 61190-17  
 17 cm, 6 3/4"

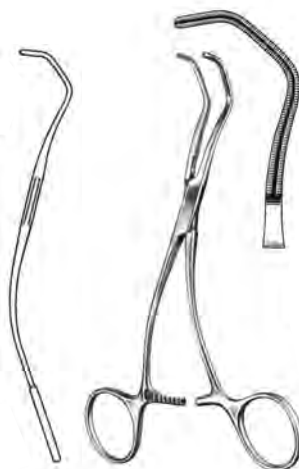

COOLEY  
 61191-16  
 16 cm, 6 1/4"



COOLEY  
 61192-17  
 17 cm, 6 3/4"

Kinder-Aortaklemme  
 Pediatric Aortic Clamps  
 Pinza aórticas pediátricas  
 Pinze per aorta pediatriche

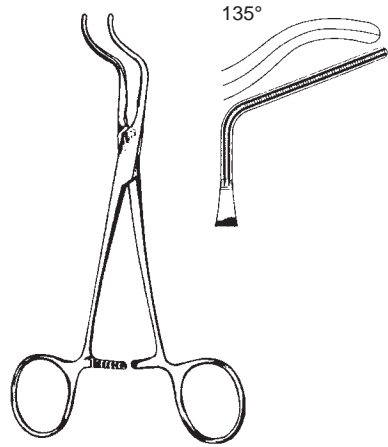

SUBRAMANIAN-MINIATURE  
 61259-15 15,5 cm, 6"

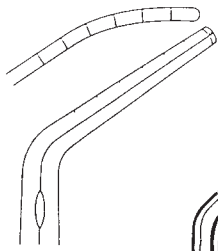

rechts  
 right  
 derecha  
 destra

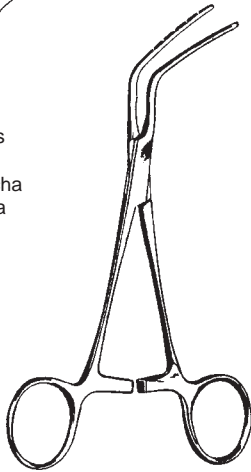

SUBRAMANIAN  
 61261-16 16 cm, 6 1/4"

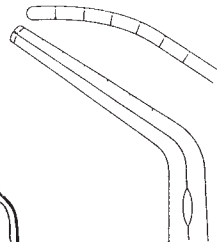

links  
 left  
 izquierda  
 sinistra

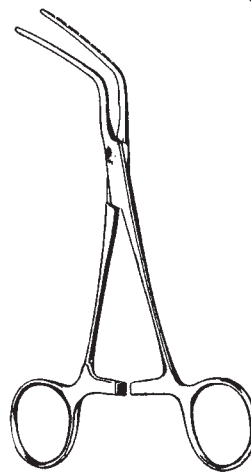

SUBRAMANIAN  
 61263-16 16 cm, 6 1/4"

Atrauma Neonatal- und Kinderklemmen, extra feine Modelle  
 Atrauma and Pediatric clamps, delicate Patterns  
 Pinzas-clamps para recién nacidos y pediátricos, modelos muy delicados, atraumáticos  
 Pinze Atrauma per neonati e bambini, modelli estremamente fini

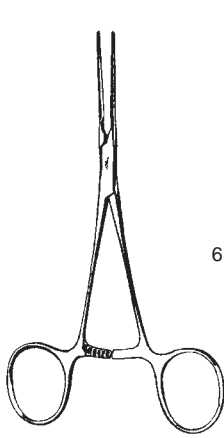

61266-01  
 14 cm  
 5 1/2"

61266-02  
 14 cm  
 5 1/2"

COOLEY  
 61266-01 - 61266-02  
 14 cm, 5 1/2"

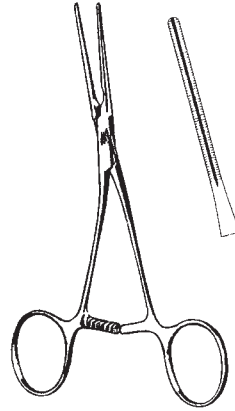

COOLEY  
 61266-03 14 cm, 5 1/2"

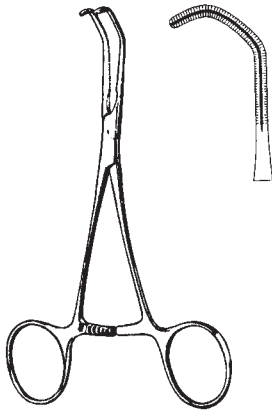

COOLEY  
 61266-04 14 cm, 5 1/2"

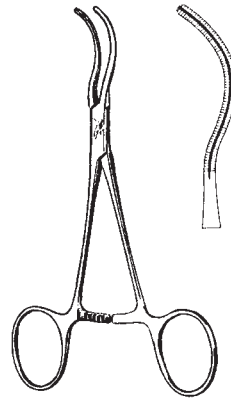

COOLEY  
 61266-05 14 cm, 5 1/2"

Atrauma Neonatal- und Kinderklemmen  
 Neonatal and Pediatric Clamps  
 Pinzas-clamps pediátricas y para recién-nacidos, atraumáticas  
 Pinze per neonati e bambini

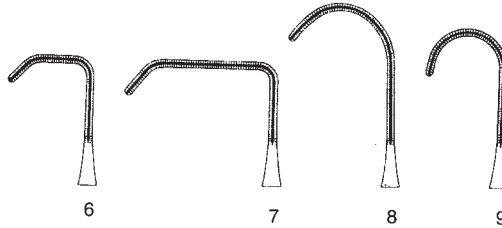
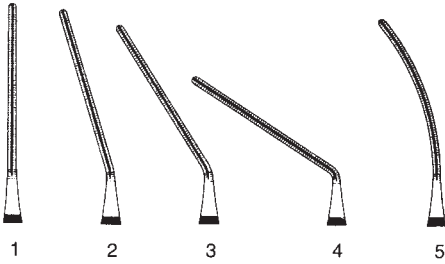
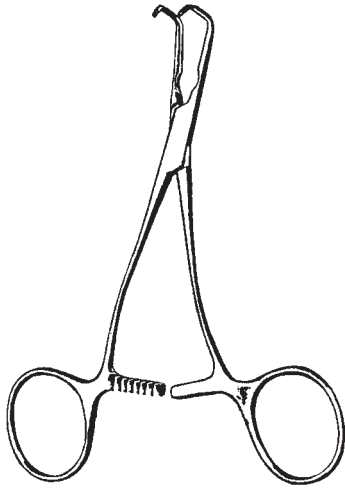

gerade  
straight  
rectas  
rette

Fig.	
1	61372-01 14 cm, 5 1/2"
2	61372-02 14 cm, 5 1/2"
3	61372-03 14 cm, 5 1/2"
4	61372-04 13 cm, 5 1/8"
5	61372-05 14 cm, 5 1/2"
6	61372-06 13 cm, 5 1/8"
7	61372-07 13 cm, 5 1/8"
8	61372-08 14 cm, 5 1/2"
9	61372-09 13,5 cm, 5 1/4"



stark abgewinkelt  
strongly angled  
ramas anguladas  
forte angolata

Fig.	
1	61373-01 14 cm, 5 1/2"
2	61373-02 14 cm, 5 1/2"
3	61373-03 14 cm, 5 1/2"
4	61373-04 13 cm, 5 1/8"
5	61373-05 14 cm, 5 1/2"
6	61373-06 13 cm, 5 1/8"
7	61373-07 13 cm, 5 1/8"
8	61373-08 14 cm, 5 1/2"
9	61373-09 13,5 cm, 5 1/4"

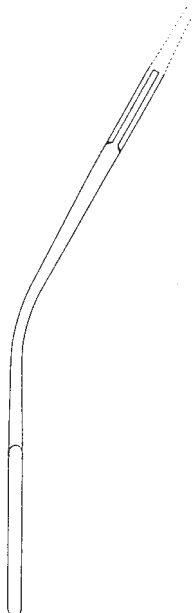

abgewinkelt  
angled  
acodadas  
angolate

Fig.	
1	61374-01 14 cm, 5 1/2"
2	61374-02 14 cm, 5 1/2"
3	61374-03 14 cm, 5 1/2"
4	61374-04 13 cm, 5 1/8"
5	61374-05 14 cm, 5 1/2"
6	61374-06 13 cm, 5 1/8"
7	61374-07 13 cm, 5 1/8"
8	61374-08 14 cm, 5 1/2"
9	61374-09 13,5 cm, 5 1/4"



Clipanlagezangen für die offene Chirurgie 25° aufgebogen  
Clip Applicators for open Surgery 25° upcurved  
Pinza aplicadora de clips para cirugía abierta con ángulo de 25°  
Pinza applicatore clips per chirurgia aperto, curvo in alto 25°



15 cm, 6"

**Horizon**

61460-15 Small gelb / yellow / jaune/ amarillo/ giallo  
61461-15 Medium blau / blue / bleu / azul / blu

**SLS Clips**

61464-15 Micro weiss / white / blanc / blanco / bianco  
61465-15 Small gelb / yellow / jaune/ amarillo/ giallo  
61466-15 Small medium lila / lilac / lilas / lila / lilla  
61467-15 Medium blau / blue / bleu / azul / blu

**Ethicon**

61470-15 Small blau / blue / bleu / azul / blu  
61471-15 Medium weiss / white / blanc / blanco / bianco

**Pilling**

61481-15 Small gelb / yellow / jaune / amarillo / giallo  
61482-15 Medium blau / blue / bleu / azul / blu

**Horizon**

61460-19 Small gelb / yellow / jaune / amarillo / giallo  
61461-19 Medium blau / blue / bleu / azul / blu  
61462-19 Medium Large grün / green / verde / verde  
61463-19 Large orange / naranja / arancione

**SLS Clips**

61464-19 Micro weiss / white / blanc / blanco / bianco  
61465-19 Small gelb / yellow/ jaune / amarillo / giallo  
61466-19 Small medium lila / lilac / lilas / lila / lilla  
61467-19 Medium blau / blue / bleu / azul / blu  
61468-19 Medium Large grün / green / verde / verde  
61469-19 Large orange / naranja / arancione

**Ethicon**

61470-19 Small blau / blue / bleu / azul / blu  
61471-19 Medium weiss / white / blanc / blanco / bianco  
61472-19 Medium Large grün / green / verde / verde  
61473-19 Large gelb / yellow / jaune / amarillo / giallo

**Pilling**

61481-19 Small gelb / yellow / jaune / amarillo / giallo  
61482-19 Medium blau / blue / bleu / azul / blu  
61484-19 Medium Large grün / green / verde / verde  
61483-19 Large orange / naranja / arancione



19 cm, 7 1/2"

Clipanlegezangen für die offene Chirurgie 25° aufgebogen  
Clip Appliers for open Surgery 25° upcurved  
Pinza aplicadora de clips para cirugía abierta con ángulo de 25°  
Pinza applicatore clips per chirurgia aperto, curvo in alto 25°

**Horizon**

- 61461-28 Medium blau / blue / bleu / azul / blu
- 61462-28 Medium Large grün / green / verde / verde
- 61463-28 Large orange / naranja / arancione

**SLS Clips**

- 61464-28 Micro weiss / white / blanco / bianco
- 61465-28 Small gelb / yellow / jaune / amarillo / giallo
- 61466-28 Small medium lila / lilac / lilas / lila / lilla
- 61467-28 Medium blau / blue / bleu / azul / blu
- 61468-28 Medium Large grün / green / verde / verde
- 61469-28 Large orange / naranja / arancione

**Ethicon**

- 61471-28 Medium weiss / white / blanco / bianco
- 61472-28 Medium Large grün / green / verde / verde
- 61473-28 Large gelb / yellow / jaune / amarillo / giallo

**Pilling**

- 61482-28 Medium blau / blue / bleu / azul / blu
- 61484-28 Medium Large grün / green / verde / verde
- 61483-28 Large orange / naranja / arancione



28 cm, 11"



Atrauma Cardiovascular-Klemmen, extra feine Modelle  
Atrauma Cardiovascular Forceps, extra delicate Patterns  
Pinzas-clamps cardiovasculares, modelos muy delicados, atraumáticos  
Pinze atraumatiche per chirurgia vascolare, modelli delicati

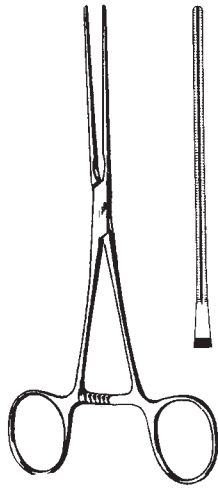

61488-16  
16,5 cm, 6 1/2"

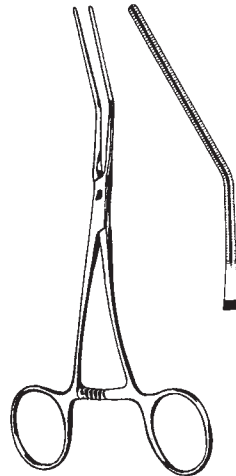

61489-16  
16 cm, 6 1/4"

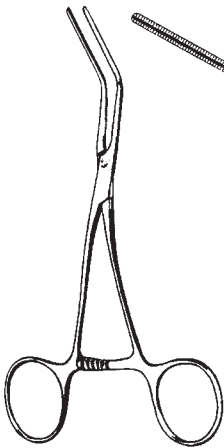

61490-15  
15 cm, 6"

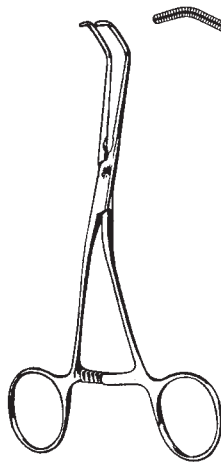

61491-15  
15 cm, 6"

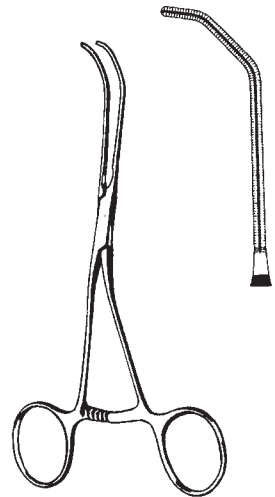

61492-16  
15,5 cm, 6"

Neonatal-Klemmen  
Neonatal-Clamps  
Pinzas-clamps para recién-nacidos  
Pinze per neonati

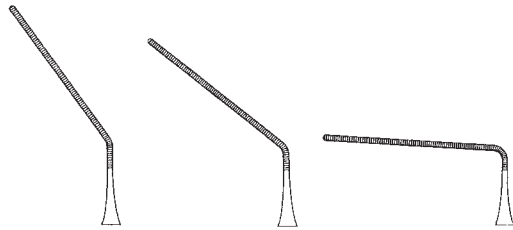

61493-01  
13 cm  
5 1/8"

61493-02  
13 cm  
5 1/8"

61493-03  
11 cm  
4 3/8"

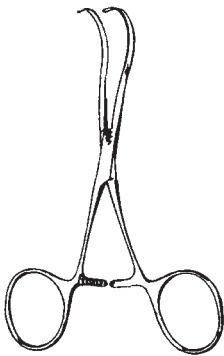

CASTANEDA  
61493-01 - 61495-04

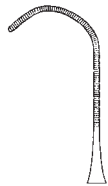

61495-01  
12 cm  
4 3/4"

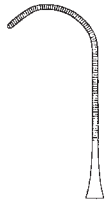

61495-02  
12 cm  
4 3/4"



61495-03  
12 cm  
4 3/4"

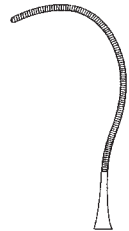

61495-04  
12 cm  
4 3/4"

Aorta Dilatatore, Tourniquets  
 Aortic Dilators, Tourniquets  
 Diladores de aorta, Tourniquets  
 Dilattori vascolari, Tornichetti

Spreizweite von 8 - 42 mm  
 Blade opening from 8 to 42 mm  
 Abertura de 8 a 42 mm  
 Apertura da 8 a 42 mm

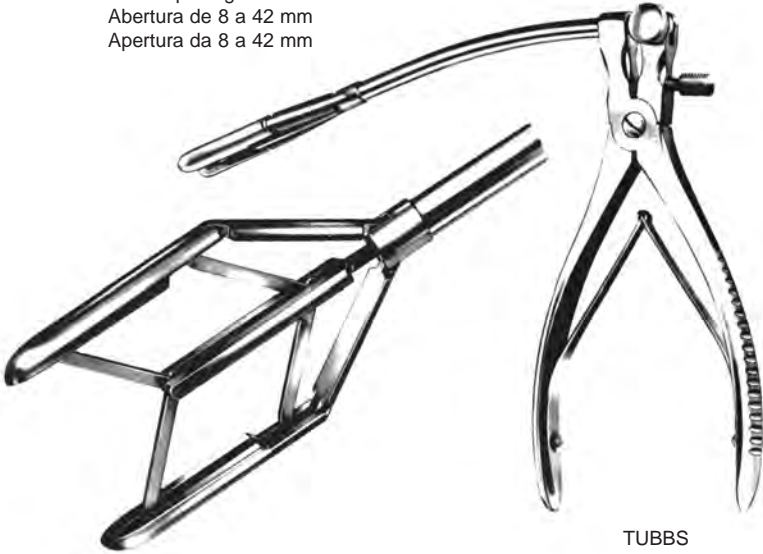

TUBBS  
 61500-00

Spreizweite von 8 - 15 mm  
 Blade opening from 8 to 15 mm  
 Abertura de 8 a 15 mm  
 Apertura da 8 a 15 mm



COOLEY  
 61506-00



RUMEL-BELMONT  
 61700-33 3,2 mm Ø  
 61710-33 6,4 mm Ø  
 33 cm, 13"  
 flexibel, flexible,  
 flexible, flessibile

61700-01  
 61710-01  
 Mandrin alleine  
 Guide only  
 Guida sola

Gefäß-Dilatatoren  
 Vascular Dilatores  
 Dilatadores vasculares  
 Dilatatori vascolari

biegsam  
 malleable  
 maleables  
 malleabili

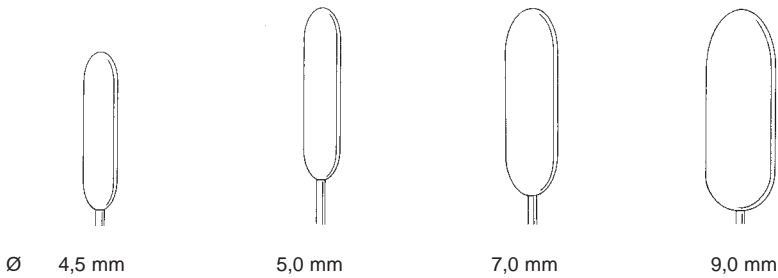
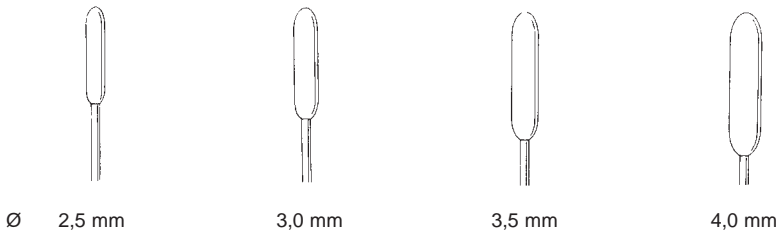
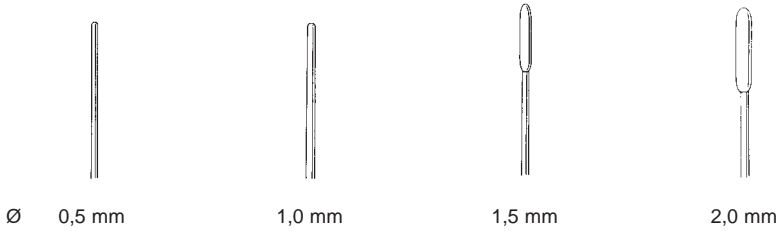

DE BAKEY		
19 cm, 7 1/2"	Ø mm	35 cm, 13 3/4"
61810-05	0,5	61820-05
61810-10	1,0	61820-10
61810-15	1,5	61820-15
61810-20	2,0	61820-20
61810-25	2,5	61820-25
61810-30	3,0	61820-30
61810-35	3,5	61820-35
61810-40	4,0	61820-40
61810-45	4,5	61820-45
61810-50	5,0	61820-50
61810-70	7,0	61820-70
61810-90	9,0	61820-90

Spatel, Gefäßdissektoren  
 Spatula, vascular Dissectors  
 Espátulas, Disecadores vasculares  
 Spatola, Dissettori vascolari

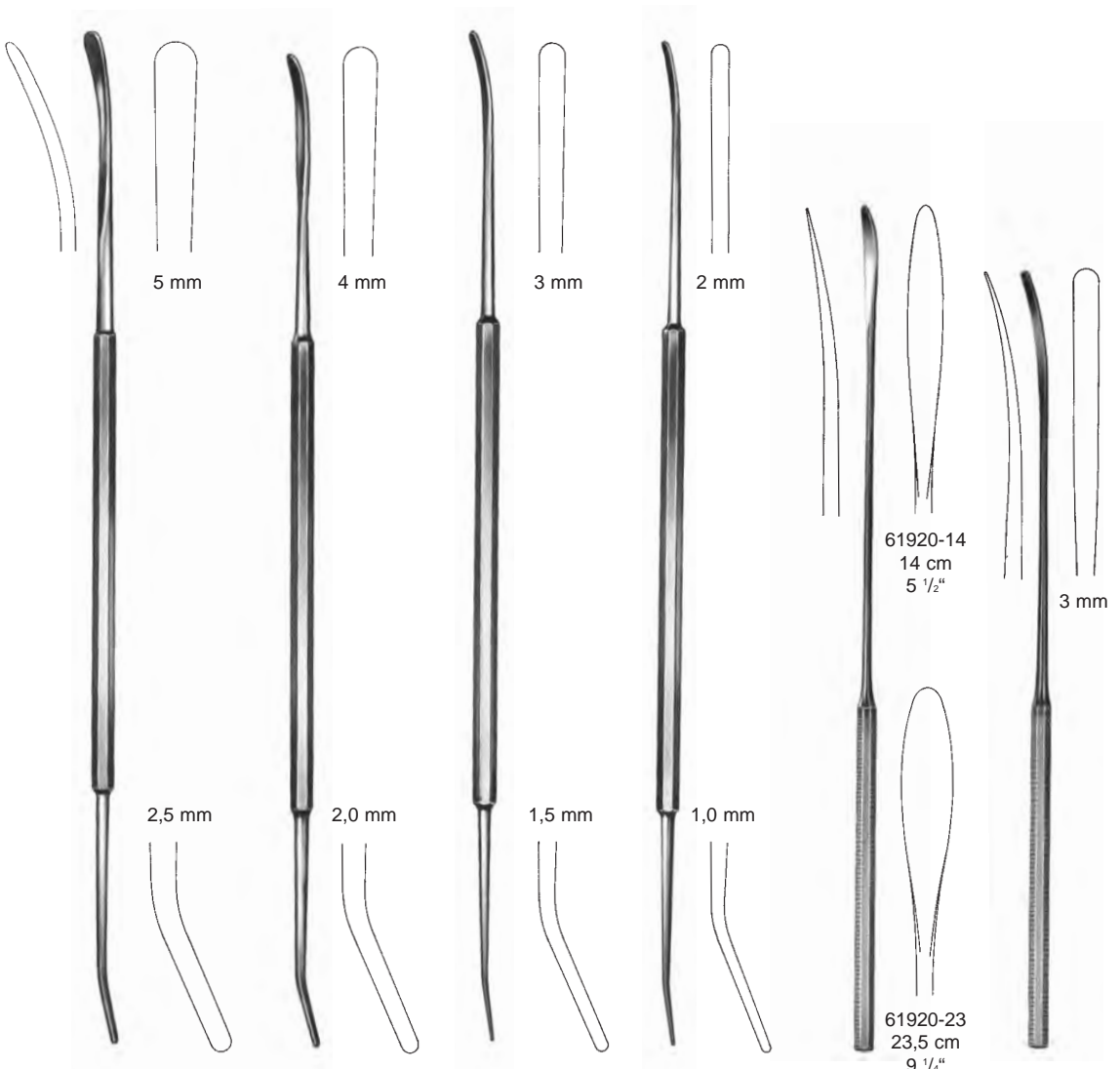

ROBB  
 24 cm  
 9 1/2"

Fig. 1  
 61910-01

Fig. 2  
 61910-02

Fig. 3  
 61910-03

Fig. 4  
 61910-04

stumpf  
 blunt  
 roma  
 smussa

61930-18  
 18,5 cm, 7 1/4"

61930-21  
 21,5 cm, 8 1/2"

stumpf  
 blunt  
 roma  
 smussa

Gallensteinzangen  
 Gall Stone Forceps  
 Pinzas para cálculos biliares  
 Pinze per calcoli biliari



DESJARDINS  
 23 cm, 9"

Fig. 1  
 63101-23



Fig. 2  
 63103-23

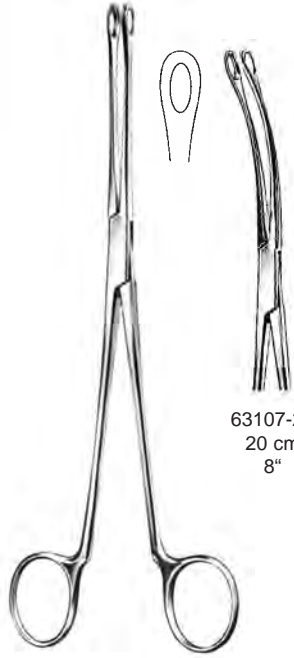

BLAKE  
 63106-20 20 cm, 8"

63107-20  
 20 cm  
 8"



MAYO-BLAKE  
 63110-20 20 cm, 8"



MAYO-BLAKE  
 63111-20 20 cm, 8"



MIXTER  
 63117-22 22 cm, 8 3/4"

Gallensteinsonden, Gallengangdilatoren  
 Gall Stone Probes, Bile duct dilators  
 Exploradores para cálculos biliares, Dilatadores para conductos biliares  
 Sonde per calcoli biliari, Dilatatori per condotti biliari

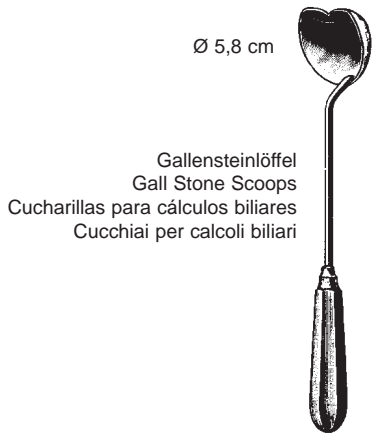

Ø 5,8 cm

Gallensteinlöffel  
 Gall Stone Scoops  
 Cucharillas para cálculos biliares  
 Cucchiai per calcoli biliari

MOOR  
 63125-28  
 28 cm, 11"

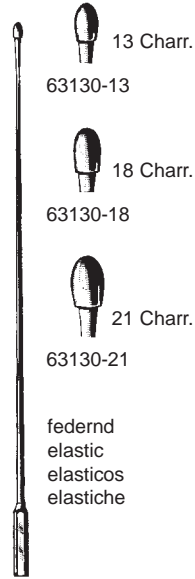

13 Charr.  
 63130-13

18 Charr.  
 63130-18

21 Charr.  
 63130-21

federnd  
 elastic  
 elasticos  
 elastiche

DESJARDINS  
 63130-13 - 63130-21  
 28 cm, 11"

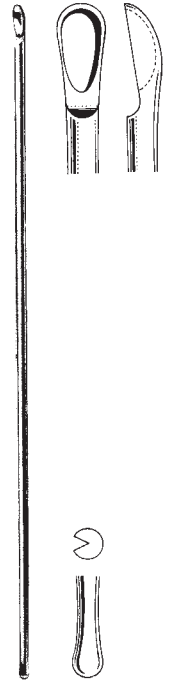

MOYNIHAN  
 63142-34 34 cm, 13 1/2"

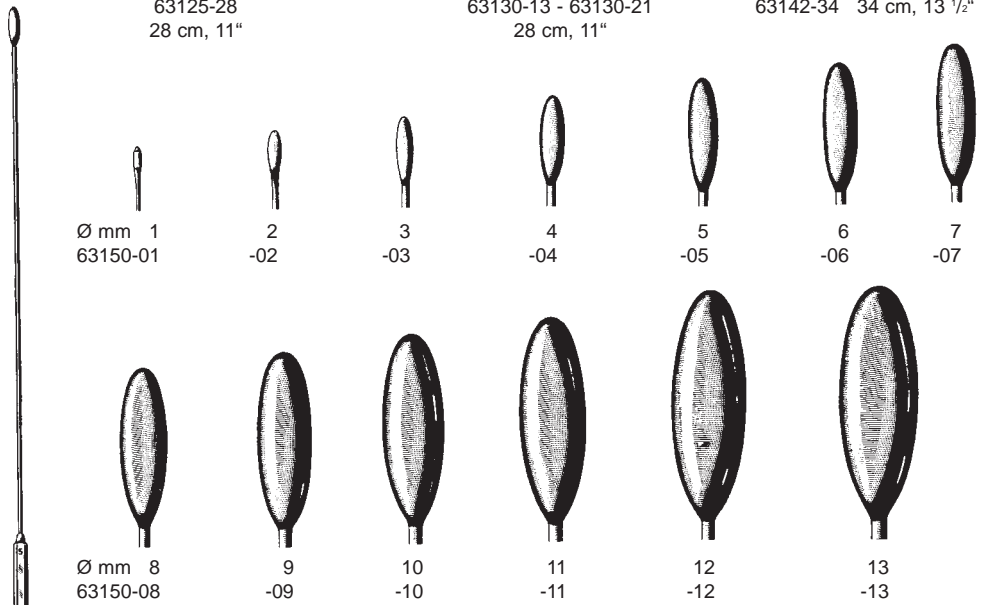

Ø mm 1  
 63150-01

2  
 -02

3  
 -03

4  
 -04

5  
 -05

6  
 -06

7  
 -07

Ø mm 8  
 63150-08

9  
 -09

10  
 -10

11  
 -11

12  
 -12

13  
 -13

biegsam  
 malleable  
 maleable  
 malleabili

BAKES

63150-01 - 63150-13  
 30 cm, 11 3/4"

63150-00 = Satz à 9 St. / set of 9 size 3 to 11  
 juego de 9 fig. 3-11 / serie di 9 pezzi

Gallensteinlöffel  
 Gall Stone Scoops  
 Cucharillas para cálculos biliares  
 Cucchiari per calcoli biliari

biegsam  
 malleable  
 maleables  
 malleabili



LUER-KOERTE  
 63173-01 - 63173-08  
 32 cm, 12 3/4"

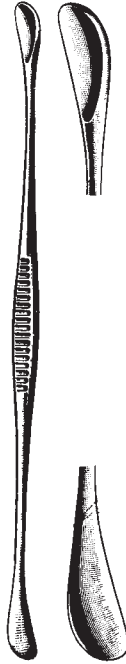

FERGUSSON  
 63170-21 - 63170-23

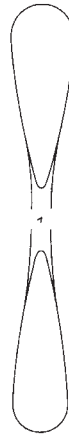

63170-21  
 21,5 cm  
 8 1/2"

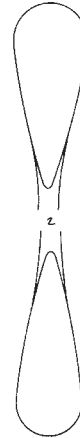

63170-22  
 22 cm  
 8 3/4"

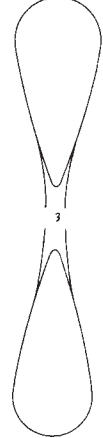

63170-23  
 23,5 cm  
 9 1/4"

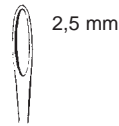

Fig. 000  
 63173-01

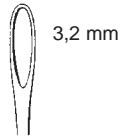

Fig. 00  
 63173-02

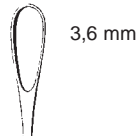

Fig. 0  
 63173-03

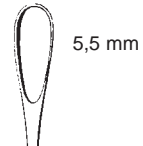

Fig. 1  
 63173-04

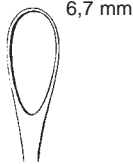

Fig. 2  
 63173-05

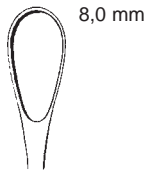

Fig. 3  
 63173-06

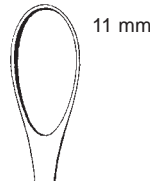

Fig. 4  
 63173-07

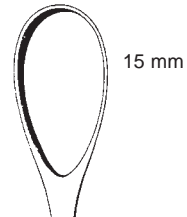

Fig. 5  
 63173-08



Gallensteinlöffel  
 Gall Stone Scoops  
 Cucharillas para cálculos biliares  
 Cucchiari per calcoli biliari



MAYO  
 63175-27  
 27 cm, 10 1/2"



63178-01  
 Klein, small, pequeña, piccola

63178-03  
 groß, large, grande

MAYO  
 63178-01 - 63178-03  
 27 cm, 10 1/2"



17 Charr.

Fig. 1  
 63180-17



21 Charr.

Fig. 2  
 63180-21



24 Charr.

Fig. 3  
 63180-24



27 Charr.

Fig. 4  
 63180-27

federnd  
 elastic  
 elásticas  
 elastiche

DESJARDINS  
 63180-17 - 63180-27  
 30 cm, 11 3/4"



MAYO  
 63210-32  
 32 cm, 12 3/4"

Nierensteinzange, Nierenfistelzange  
 Kidney Stone Forceps, Nephrostomy Forceps  
 Pinzas para cálculos renales, Pinza para nefrostomía  
 Pinze per calcoli renali, Pinze per nefrostomia



RANDALL

- Fig. 1 63231-01 23 cm, 9"
- Fig. 2 63231-02 22 cm, 8 3/4"
- Fig. 3 63231-03 22 cm, 8 3/4"
- Fig. 4 63231-04 22 cm, 8 3/4"
- Fig. 5 63231-05 19 cm, 7 1/2"
- Fig. 6 63231-06 19 cm, 7 1/2"

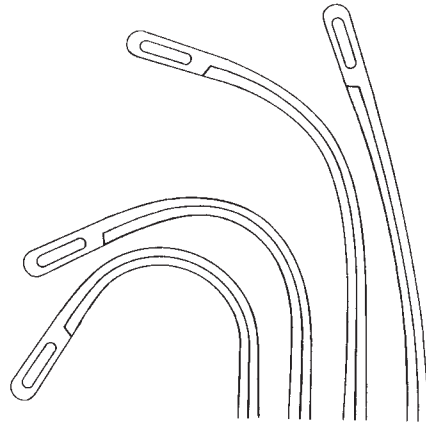

Fig. 4 Fig. 3 Fig. 2 Fig. 1

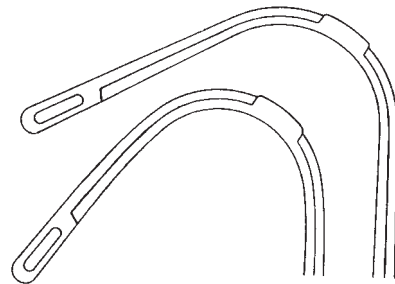

Fig. 6 Fig. 5

Nierensteinzange  
Kidney Stone Forceps  
Pinzas para cálculos renales  
Pinze per calcoli renali



HEIMING

für Kinder  
for children  
para niños  
per bambini



63232-01  
17 cm, 6 <sup>3</sup>/<sub>4</sub>"



63232-02  
16 cm, 6 <sup>1</sup>/<sub>4</sub>"

Darm-Organfaßzangen  
 Bowel and Tissue Grasping Forceps  
 Pinzas para coger intestinos y tejidos  
 Pinze per afferrare intestini e tessuti

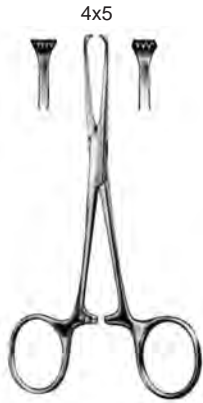

ALLIS-BABY  
 65102-12 12 cm, 4 3/4"  
 65102-14 14 cm, 5 1/2"

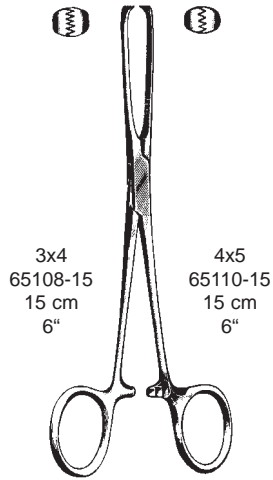

3x4 4x5  
 65108-15 65110-15  
 15 cm 15 cm  
 6" 6"

ALLIS 5x6  
 15 cm 6" 65120-15  
 19 cm 7 1/2" 65120-19  
 22 cm 8 3/4" 65120-22  
 24 cm 9 1/2" 65120-24

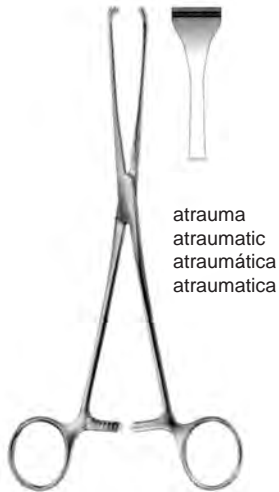

atrauma  
 atraumatic  
 atraumática  
 atraumatica

ALLIS  
 65124-16 16 cm, 6 1/4"  
 65124-20 20 cm, 8"  
 65124-22 22 cm, 8 3/4"  
 65124-25 25 cm, 10"  
 65124-30 30 cm, 11 3/4"

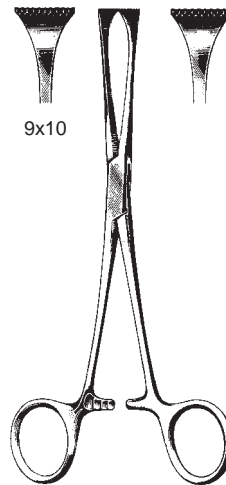

9x10

ALLIS-ADAIR  
 65130-15  
 15,5 cm, 6"

Darm-Organfaßzangen  
 Bowel and Tissue Grasping Forceps  
 Pinzas para coger intestinos y tejidos  
 Pinze per afferrare intestini e tessuti

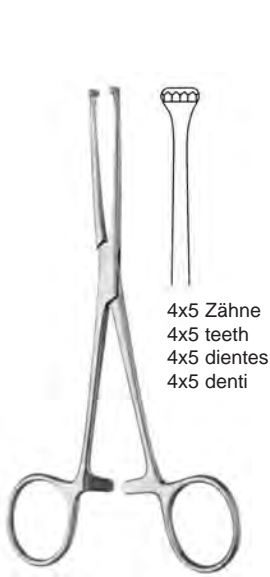

4x5 Zähne  
 4x5 teeth  
 4x5 dientes  
 4x5 denti

LOCKWOOD-ALLIS  
 65132-16 16 cm, 6 1/4"  
 65132-20 20 cm, 8"

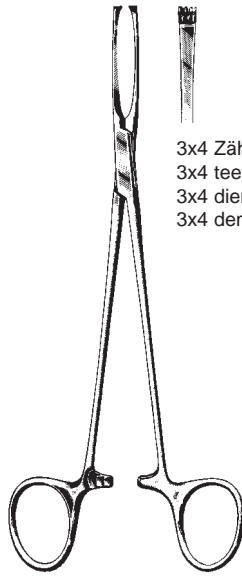

3x4 Zähne  
 3x4 teeth  
 3x4 dientes  
 3x4 denti

JUDD-ALLIS  
 65140-15 15 cm, 6"  
 65140-19 19 cm, 7 1/2"



5x6 Zähne  
 5x6 teeth  
 5x6 dientes  
 5x6 denti

BOYS-ALLIS  
 65145-15 15 cm, 6"

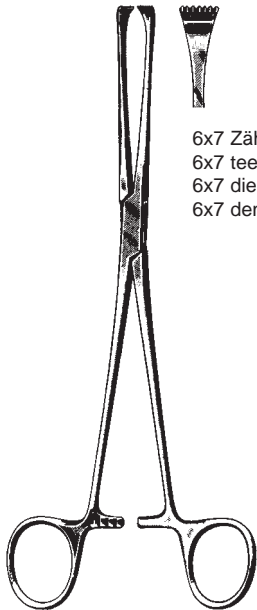

6x7 Zähne  
 6x7 teeth  
 6x7 dientes  
 6x7 denti

THOMS-ALLIS  
 65150-20 20 cm, 8"



2x3 Zähne  
 2x3 teeth  
 2x3 dientes  
 2x3 denti

LITTLEWOOD  
 65154-18 18,5 cm, 7 1/4"

Darmfaßzangen  
 Intestinal Forceps  
 Pinzas para coger tejidos e intestinos  
 Pinze per afferrare tessuti ed organi

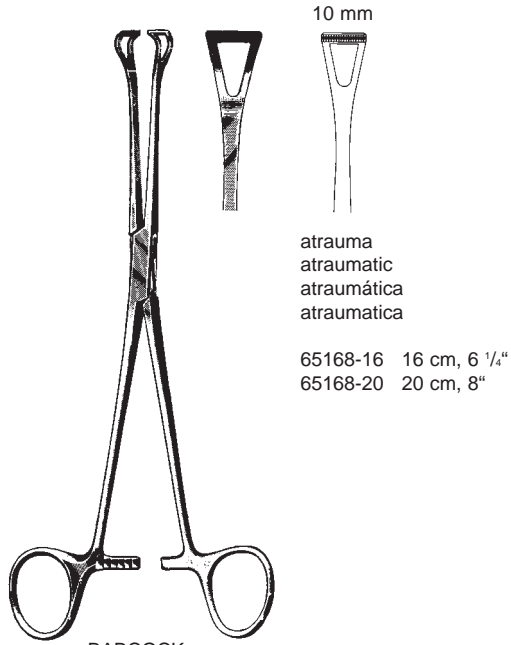

10 mm

atrauma  
 atraumatic  
 atraumática  
 atraumatica

65168-16 16 cm, 6 1/4"  
 65168-20 20 cm, 8"

BABCOCK

- 65160-14 14 cm, 5 1/2"
- 65160-16 16 cm, 6 1/4" **65164-16 TC 16 cm**
- 65160-18 18 cm, 7"
- 65160-20 20 cm, 8" **65164-20 TC 20 cm**
- 65160-24 24 cm, 9 1/2"

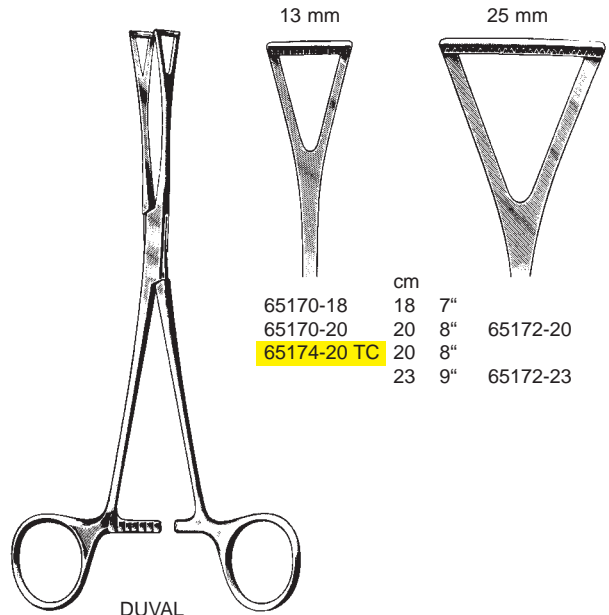

13 mm

25 mm

65170-18	18	7"	
65170-20	20	8"	65172-20
<b>65174-20 TC</b>	20	8"	
	23	9"	65172-23

DUVAL  
 65170-18 - 65172-23

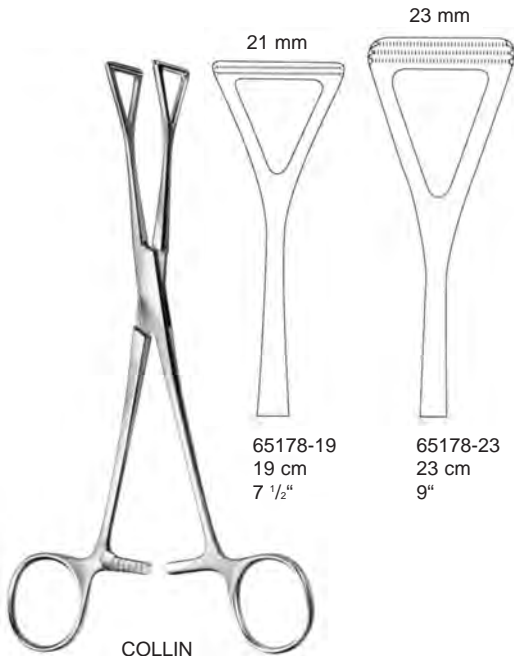

21 mm

23 mm

65178-19  
 19 cm  
 7 1/2"

65178-23  
 23 cm  
 9"

COLLIN



WILLIAMS  
 65180-16 16,5 cm, 6 1/2"

Darmklemmen  
 Intestinal Forceps  
 Pinzas intestinales  
 Pinze intestinali

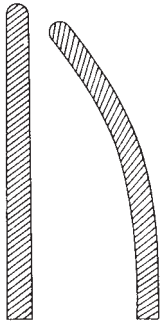
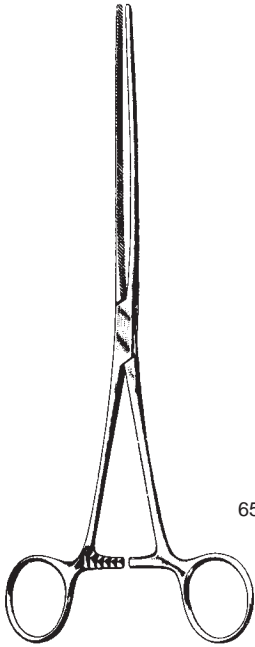

DOYEN-BABY  
 65210-18 65211-18  
 18 cm, 7"

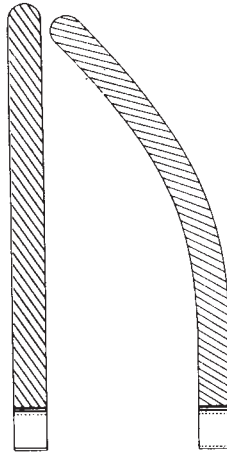

DOYEN  
 65210-21 21 cm, 8 1/4"  
 65210-23 23 cm, 9"

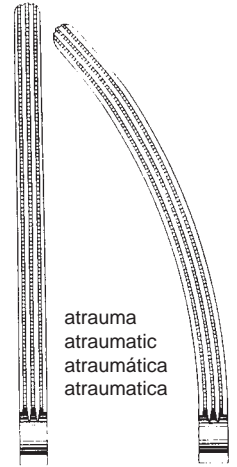

atrauma  
 atraumatic  
 atraumática  
 atraumatica

DOYEN  
 65216-13 13 cm, 5 1/8" 65217-13  
 65216-16 16 cm, 6 1/4" 65217-16  
 65216-18 18 cm, 7" 65217-18  
 65216-21 21 cm, 8 1/4" 65217-21  
 65216-23 23 cm, 9" 65217-23

DOYEN  
 65210-18 - 65217-23

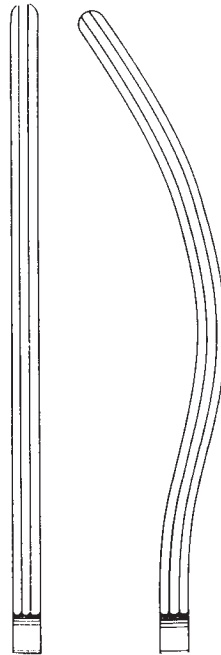
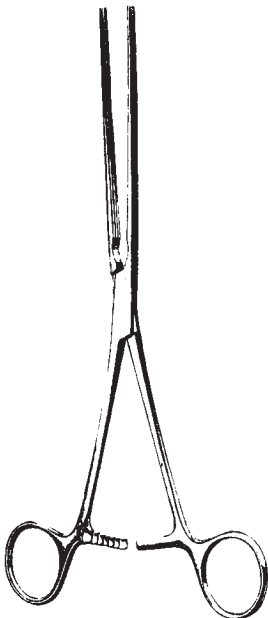

BABY-KOCHER  
 65220-13 13 cm, 5 1/8" 65221-13  
 65220-22 22 cm, 8 3/4" 65221-22  
 65220-25 25 cm, 10" 65221-25  
 65220-28 28 cm, 11" 65221-28

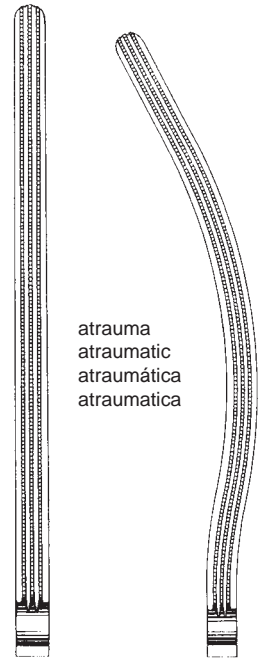

atrauma  
 atraumatic  
 atraumática  
 atraumatica

65226-22 22 cm, 8 3/4" 65227-22  
 65226-25 25 cm, 10" 65227-25  
 65226-28 28 cm, 11" 65227-28

KOCHER  
 65220-22 - 65227-28

Darmklemmen  
 Intestinal Forceps  
 Pinzas intestinales  
 Pinze intestinali

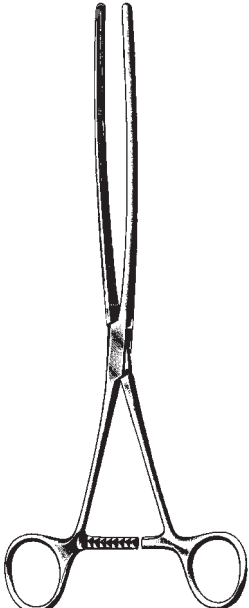

MAYO-ROBSON  
 65230-21 - 65237-25  
 21 - 25 cm  
 8 1/4" - 10"

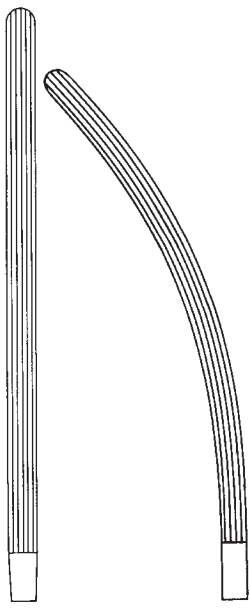

65230-21  
 65230-23  
 65230-25

65231-21  
 65231-23  
 65231-25

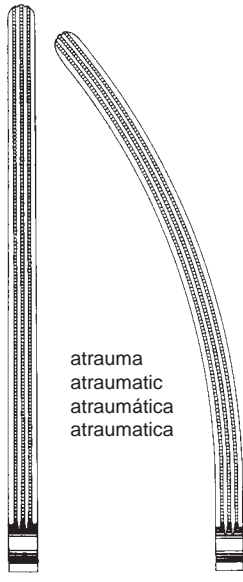

atrauma  
 atraumatic  
 atraumática  
 atraumatica

65236-25

65237-25



SCUDDER  
 65238-33  
 33 cm  
 13"

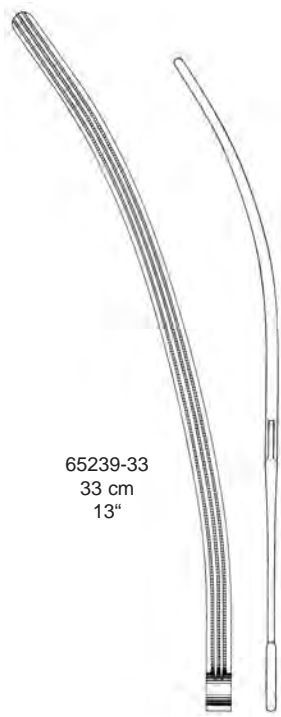
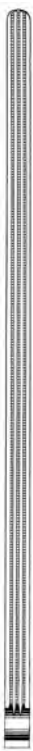

65239-33  
 33 cm  
 13"



Darmklemmen  
Intestinal Forceps  
Pinzas intestinales  
Pinze intestinali



FEHLAND  
65241-23  
23,5 cm 9 1/4"



RESANO  
65242-30  
30 cm, 11 3/4"

Magen-Darmklemmen  
Intestinal and Stomach Clamps  
Pinzas-clamps intestinales y estomacales  
Pinze intestinali e stomacali

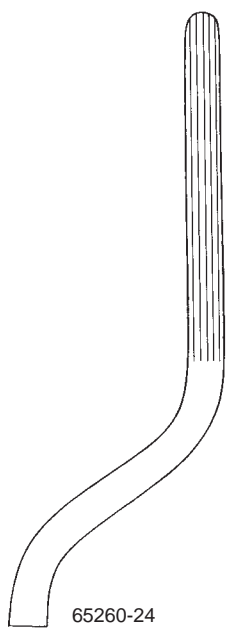
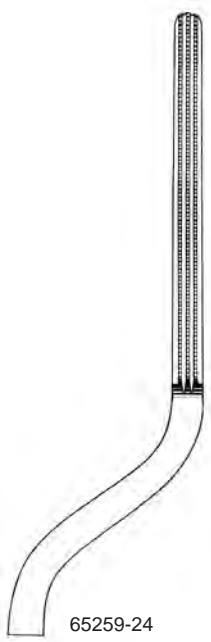
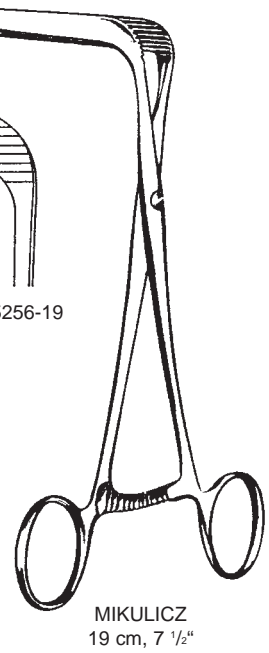
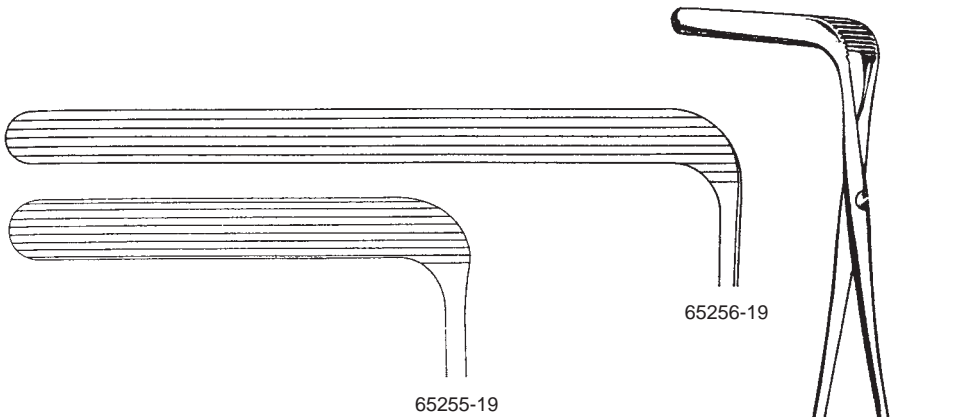

Pylorusspreizer, Blinddarmklemmen  
Pylorus spreader, Blindgut forceps  
Separador para píloro, Pinzas para apéndice  
Divaricatori per piloro, Pinza per appendice



BENSON  
65261-15  
15,5 cm, 6"



KLEINSCHMIDT  
65262-12  
12 cm, 4 3/4"

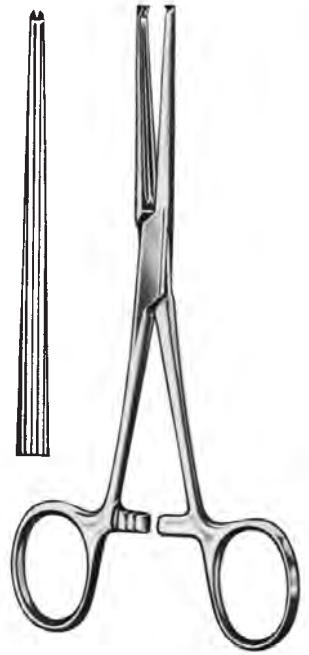

ALLEN  
65263-15 15 cm, 6"  
65263-20 20 cm, 8"

Atrauma Rektum-Anastomosenklemmen, Anastomosenklemmen  
 Atrauma Sigmoid Anastomosis Forceps, Anastomosis Clamp Forceps  
 Pinzas para anastomosis del recto atraumáticas, Pinzas clamps para anastomosis  
 Pinze atrauma per anastomosi del retto, Pinze per anastomosi



HAYES  
 65265-26 26 cm, 10 1/4"  
 65265-28 28 cm, 11"

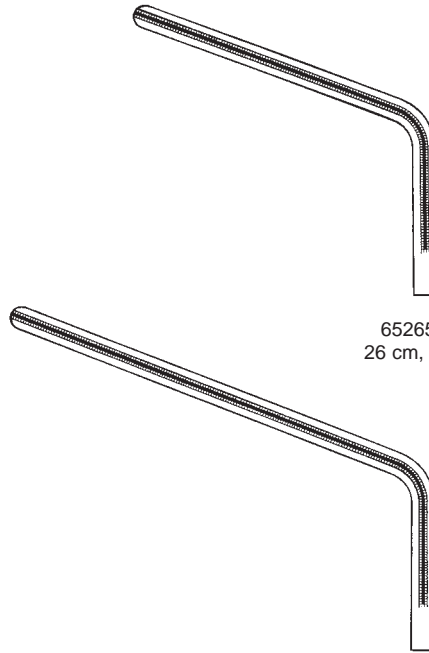

65265-26  
 26 cm, 10 1/4"

65265-28  
 28 cm, 11"

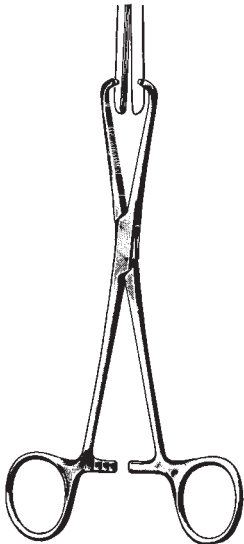

STONE  
 65270-15  
 15,5 cm, 6"



STONE-WATT  
 65272-07 7,5 cm, 3"  
 65272-10 10,0 cm, 4"



STONE-WATT  
 65274-00

Anastomosenklemmen, Klemmschließzange, Klemmenhalter  
 Anastomosis Clamp Forceps, Clamp closing forceps, Clamp Holder  
 Pinzas-clamps para anastomosis, Pinzas para cerrar clamps, Porta-clamps  
 Pinze per anastomosi, Serrapinze, Portapinze

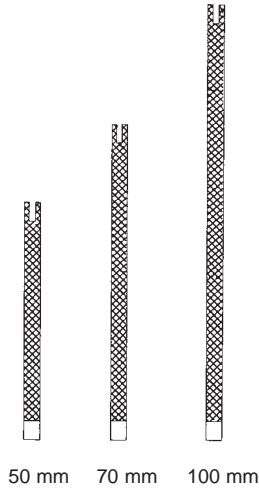

DE MARTEL-WOLFSON  
 65280-05 5 cm, 2" set of 3  
 65280-07 7 cm, 2 3/4" set of 3  
 65280-10 10 cm, 4" set of 3



DE MARTEL-WOLFSON  
 65282-26 26 cm, 10 1/4"

DE MARTEL-WOLFSON  
 65284-08 8,5 cm, 3 1/2"

DE MARTEL-WOLFSON  
 65284-23 23 cm, 9"

Magenquetschklemme  
Stomach Clamps  
Pinzas-clamps estomacales  
Pinze stomacali

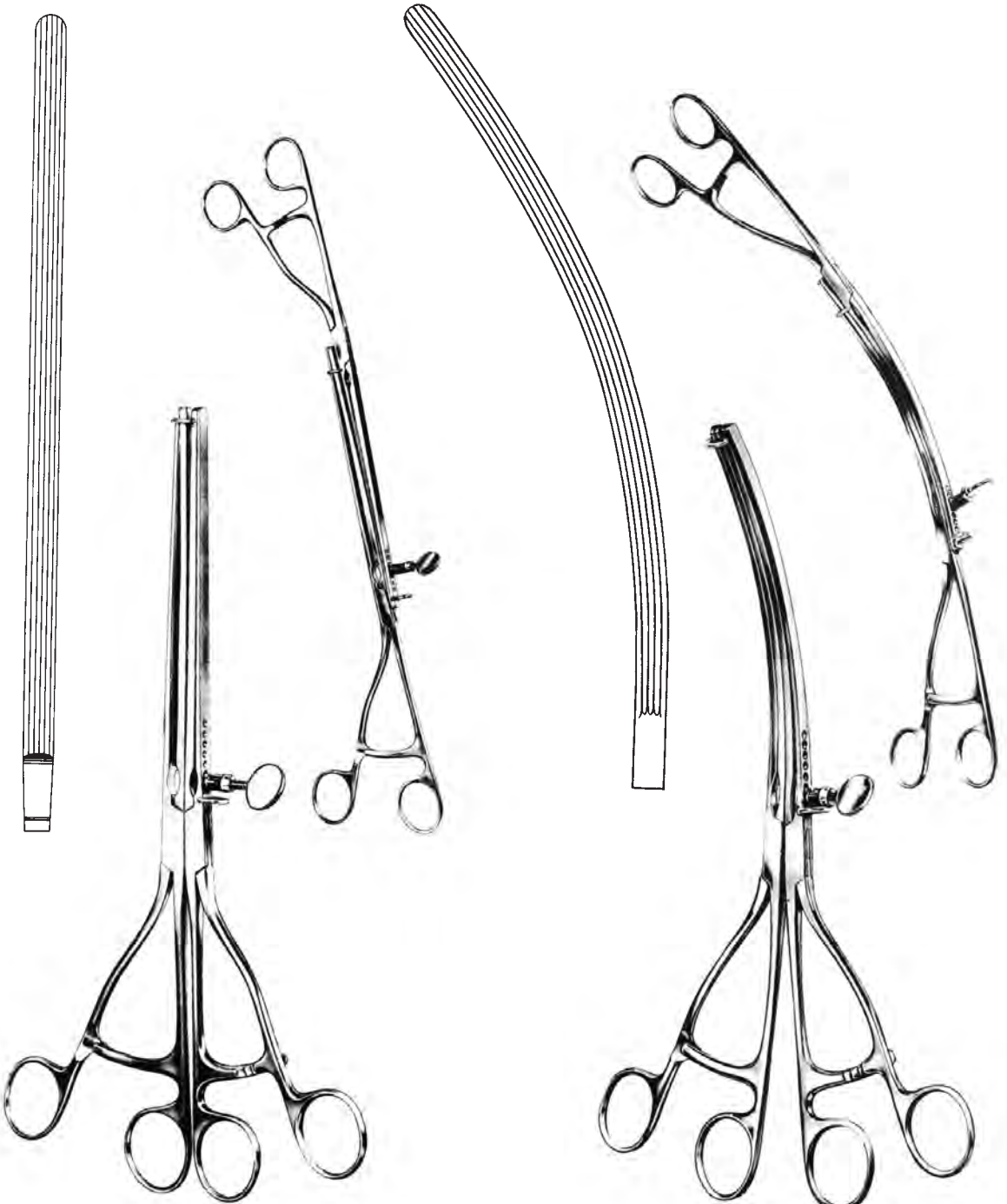

LANE  
65290-30 30 cm, 11 3/4"

LANE  
65291-30 30 cm, 11 3/4"

Darm- und Magenquetschklemmen  
Intestinal and Stomach clamps  
Pinzas-clamps intestinales y estomacales  
Pinze e Schiacciatori per l'intestino e lo stomaco

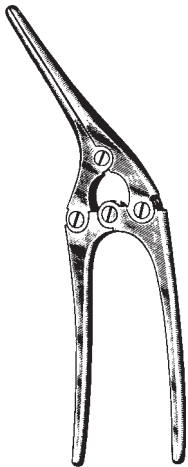

PAYR-BABY  
65310-15  
15 cm, 6"

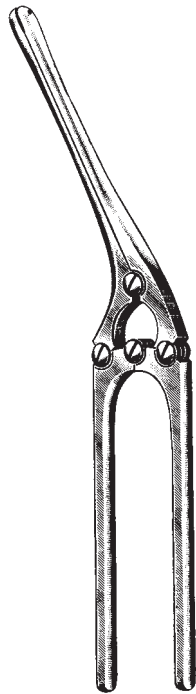

PAYR



65310-21  
21 cm, 8 1/4"



65310-29  
29 cm, 11 1/2"



65310-35  
35 cm, 14"

Magen- und Darmnähhapparat  
Stomach and Intestinal Suturing Apparatus  
Aparato para suturar estómago e intestinos  
Apparecchiature di sutura gastro-intestinale

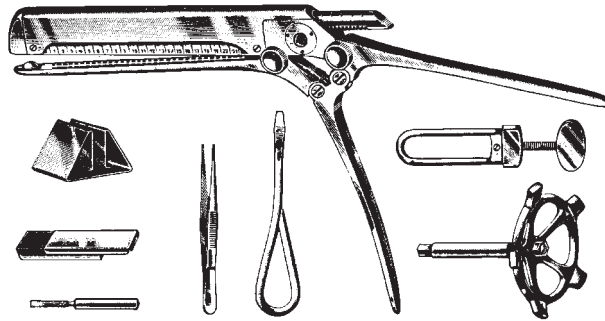

V. PETZ  
65320-00

komplett in Holzetui  
compl. in wooden case  
en estuche de madera  
in astuccio di legno

bestehend aus:

- Nähapparat
- Holzetui
- Zusatzschloß
- Kurbel
- Füllständer
- Füllstift
- Füllpinzette
- Schraubenzieher
- Etui für Klammern
- Silberklammern  
(Pack à 300 Stck.)

consisting of:

- suturing apparatus
- wooden case
- additional closing clamp
- gear wheel
- filling rack
- filling pin
- filling tweezer
- screw driver
- metal box for clips
- silver suturing clips  
(Pack of 300 ea.)

compuesto de:

- Aparator para suturar
- Estuche de madera
- Cierre adicional
- Manivela
- Soporte para rellenar
- Espiga para rellenar
- Pinza para rellenar
- Destornillador
- Estuche para agrafas
- Agrafas para sutura de plata  
(Paquete de 300 pzas.)

composta da:

- apparecchio per la sutura
- astuccio in legno
- Serratura supplementare
- manovella
- supporto di riempimento agraiffe
- perno per posizionare le agraiffe
- pinza per caricare
- cacciavite
- scatola in metallo per agraiffe
- agraiffe in argento  
(confezione da 300 pezz.)



Prostatahaken, Kapsel­faßzange, Prostatafaßzangen  
 Prostatic Retractors, Grasping Forceps for the capsule - Anterior Lobe - and Ligature Carrier  
 Separadores, Pinza para la próstata, para la cápsula, para lobo anterior, Porta-ligaduras  
 Divaricatori, Pinza per afferrare la prostata - per la capsula, per lobo anteriore

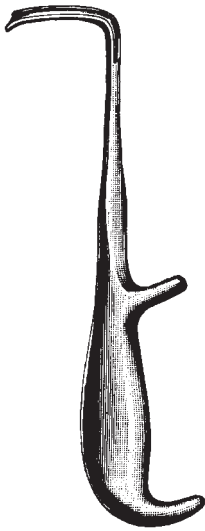

YOUNG  
 67101-21  
 21 cm, 8 1/4"

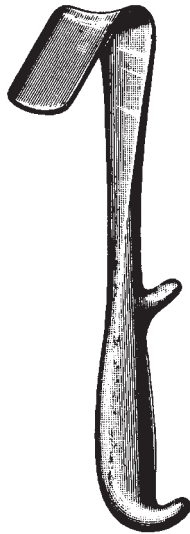

YOUNG  
 67103-22  
 22 cm, 8 3/4"

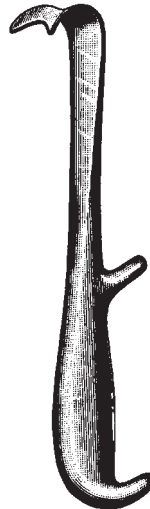

YOUNG  
 67105-21  
 21 cm, 8 1/4"



YOUNG  
 67105-22  
 22 cm, 8 3/4"

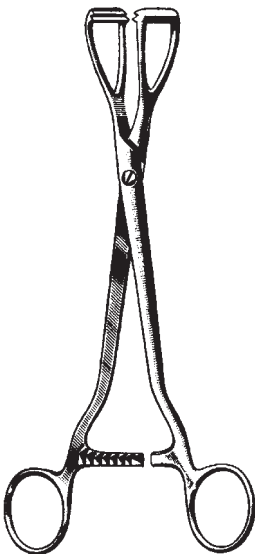

YOUNG  
 67106-20  
 20 cm, 8"

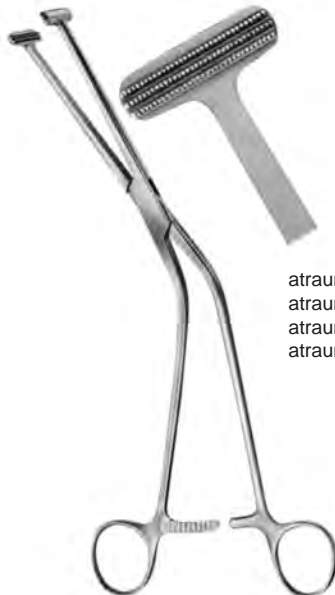

MILLIN  
 67110-23  
 23,5 cm, 9 1/4"

atrauma  
 atraumatic  
 atraumática  
 atraumatica

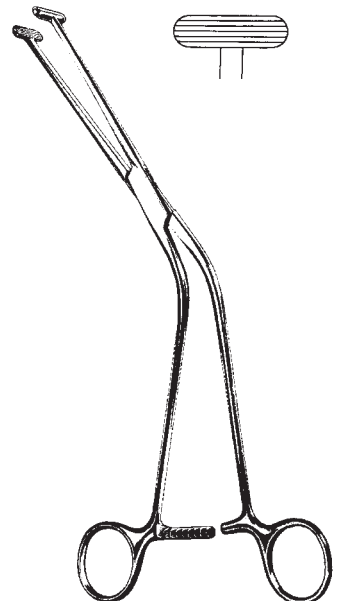

MILLIN  
 67111-23  
 23 cm, 9"

Kapselfaßzange, Prostatafaßzangen

Grasping Forceps for the capsule - Anterior Lobe - and Ligature Carrier  
Pinza para la próstata, para la cápsula, para lobo anterior, Porta-ligaduras  
Pinza per afferrare la prostata - per la capsula, per lobo anteriore, Portafilo

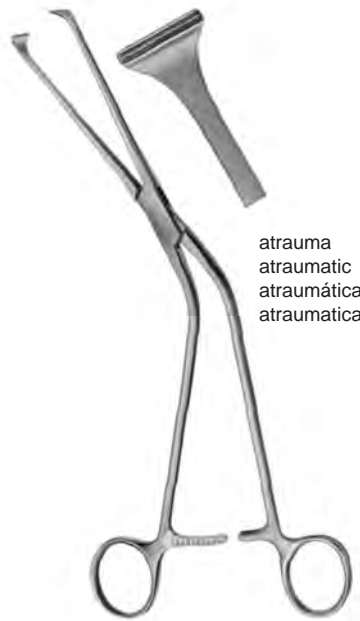

atrauma  
atraumatic  
atraumática  
atraumatica

MILLIN  
67122-23  
24,5 cm, 9 3/4"

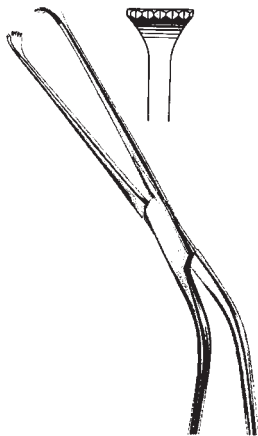

MILLIN  
67123-23  
23 cm, 9"

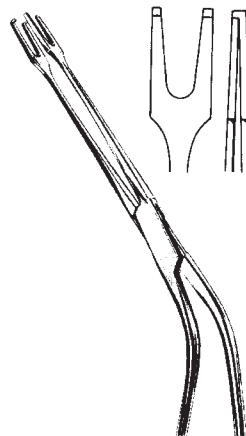

MILLIN  
67125-24  
24 cm, 9 1/2"

Prostatahaken, Blasenwundspreizer, Blasen spatel  
 Prostatic Retractors, Bladder Retractors  
 Separadores vesicales  
 Divaricatori vescicali, Spatoli vescicali

- 67130-01 2 Valven, 2 blades, 2 valvas, 2 valve 57 mm x 25 mm
- 67130-02 2 Valven, 2 blades, 2 valvas, 2 valve 80 mm x 25 mm
- 67130-03 1 Valven, 1 blade, 1 valva, 1 valve 120 mm x 45 mm



- 67130-00 ohne Kaltlicht
- 67132-00 Kaltlichtaufsatz für 67130-00
- 67130-00 without fiber optic
- 67132-00 fiber optic light carrier for 67130-00
- 67130-00 sin soporte de luz fría
- 67132-00 soporte de luz fría para 67130-00
- 67130-00 senza fibre ottiche
- 67132-00 supporto per luce fredda per 67130-00



- 67150-00 mit Mittelvalve, with Central Blade  
con valva central, con valva centrale
- 67155-00 ohne Mittelvalve, without Central Blade  
sin valva central, senza valva centr.



Blasenwundspreizer, Blasenhalssperrer, Urethrotome  
Bladder Retractors, Bladder Neck Spreader, Urethrotomes  
Separadores vesicales, Uretrótomos  
Divaricatori vescicali, Divaricatore del collo vescicale, Uretrotomi



LEGUEU  
67163-00



MILLIN  
67165-00

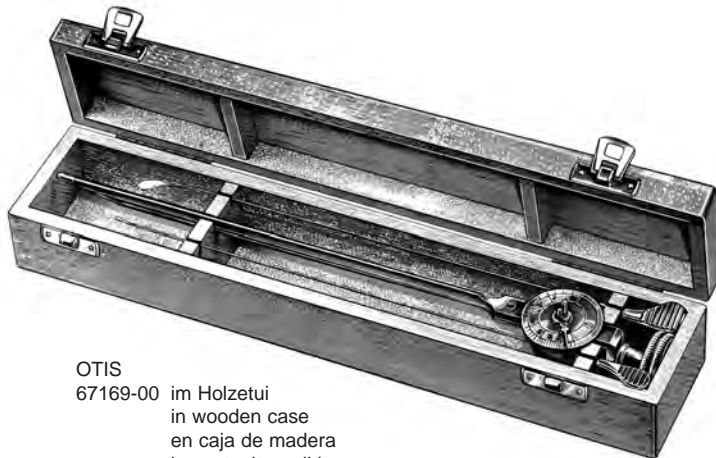

OTIS  
67169-00 im Holzetui  
in wooden case  
en caja de madera  
in contenitore di legno

67169-01 Ersatzblatt alleine  
Blade only  
Hoja de repuesto  
Lame di ricambio

Fremdkörperzange, Penisklemmen  
Foreign Body Forceps, Penis Seizing Forceps  
Pinzas para cuerpos extraños, Compresores uretrales  
Pinze per corpi estranei, Serrapene

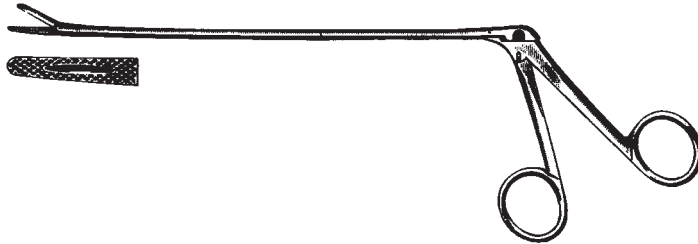

MATHIEU  
67172-20 20 cm, 8"  
67172-28 28 cm, 11"



STOCKMANN  
67175-08  
8 cm, 3 1/8"



STRAUSS  
67177-11  
11 cm, 4 3/8"

Vasektomie-Klemme  
Vasectomy Forceps  
Pinza para vasectomia  
Pinza per vasectomia



67178-12  
12 cm, 4 <sup>3</sup>/<sub>4</sub>"



67178-14  
14 cm, 5 <sup>1</sup>/<sub>2</sub>"



67179-14  
14,5 cm, 5 <sup>3</sup>/<sub>4</sub>"

Kathetereinführungsinstrumente, Dilatationsbougies  
 Catheter Introducer, Dilating Bougies  
 Introducitor de catéteres, Bujías dilatadoras  
 Mandrini per sonde uretrali, Candelette dilatatrici

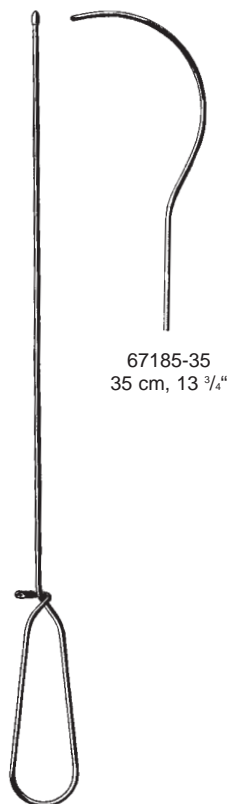

GUYON  
 67184-39  
 39 cm, 15 1/2"

Charr.	28 cm (11")	25 cm (10")	28 cm (11")	30 cm (11 3/4")
8	VAN BUREN 67201-08	GUYON 67205-08	DITTEL 67206-08	DITTEL 67207-08
9			67206-09	67207-09
10	67201-10	67205-10	67206-10	67207-10
11			67206-11	67207-11
12	67201-12	67205-12	67206-12	67207-12
13			67206-13	67207-13
14	67201-14	67205-14	67206-14	67207-14
15			67206-15	67207-15
16	67201-16	67205-16	67206-16	67207-16
17			67206-17	67207-17
18	67201-18	67205-18	67206-18	67207-18
19			67206-19	67207-19
20	67201-20	67205-20	67206-20	67207-20
21			67206-21	67207-21
22	67201-22	67205-22	67206-22	67207-22
23			67206-23	67207-23
24	67201-24	67205-24	67206-24	67207-24
25			67206-25	67207-25
26	67201-26	67205-26	67206-26	67207-26
27			67206-27	67207-27
28	67201-28	67205-28	67206-28	67207-28
29			67206-29	67207-29
30	67201-30	67205-30	67206-30	67207-30
32	67201-32	67205-32		
34	67201-34	67205-34		
36	67201-36	67205-36		
38		67205-38		
40		67205-40		

Metallkatheter  
 Metal Catheters  
 Sondas metálicas  
 Sonde metalliche

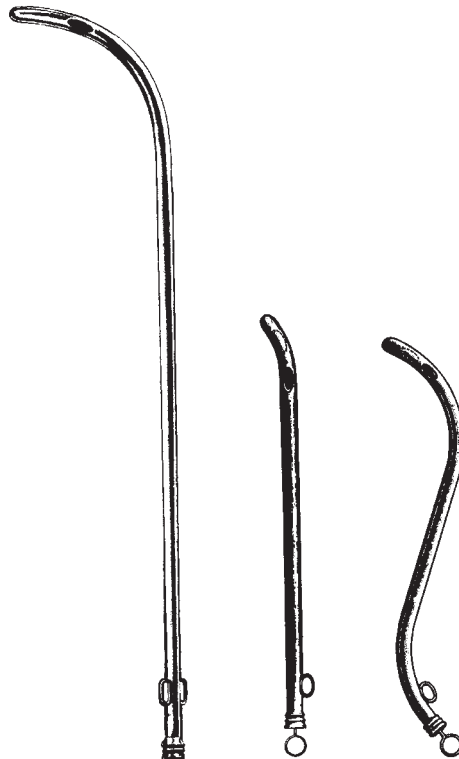

29 cm  
 11 1/2"

15 cm  
 6"

COXETER

Charr.  
 FG

6	67211-06	67213-06	
8	67211-08	67213-08	67219-08
10	67211-10	67213-10	67219-10
12	67211-12	67213-12	67219-12
14	67211-14	67213-14	67219-14
16	67211-16	67213-16	67219-16
18	67211-18	67213-18	67219-18
20	67211-20	67213-20	67219-20
22	67211-22	67213-22	67219-22
24	67211-24	67213-24	67219-24



Beschneidungsinstrument  
Circumcision Instrument  
Instrumentos para circuncisión  
Strumenti per circoncisione

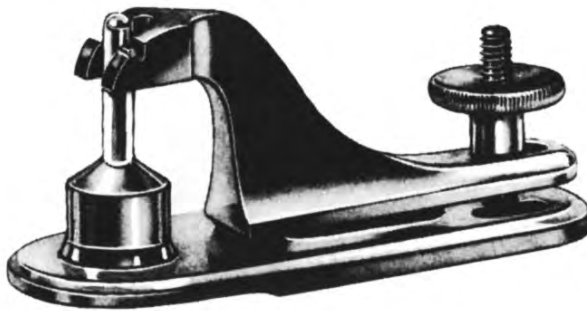

67240-08	8 mm Ø
67240-11	11 mm Ø
67240-13	13 mm Ø
67240-16	16 mm Ø
67240-21	21 mm Ø
67240-26	26 mm Ø
67240-32	32 mm Ø

67240-08 - 67240-32



MOGEN

67250-07	7,5 cm (3")	2,5 mm
67251-07	7,5 cm (3")	1,5 mm

für Kinder  
for children  
para niños  
per bambini

Mastdarm-Spekula  
Rectal Specula  
Espéculos rectales  
Specoli rettali



CZERNY  
69105-22  
22 cm, 8 3/4"



SIMS  
69110-15  
15 cm, 6"



BODENHAMMER  
69115-15  
15 cm, 6"

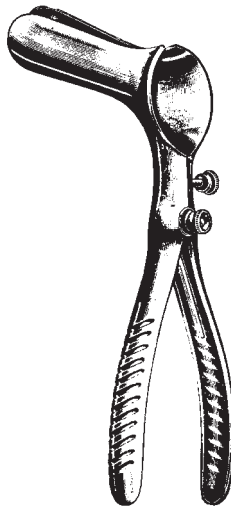

PRATT  
69121-00  
19 cm, 7 1/2"

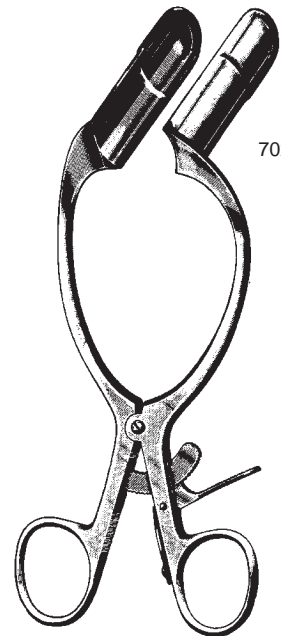

BARR  
69125-17  
17 cm, 6 3/4"

Mastdarm-Spekula  
 Rectal Specula  
 Espécules rectales  
 Specoli rettali



HILL-FERGUSON, 20 cm, 8"  
 69126-01 6,4x2,2 cm 2 1/2" x 7/8"  
 69126-02 7,6x3,0 cm 3" x 1 3/16"  
 69126-03 7,6x3,6 cm 3" x 1 7/16"



SAWYER, 25 cm, 9 3/4"  
 69127-01 6,4x2,2 cm 2 1/2" x 7/8"  
 69127-02 7,6x2,9 cm 3" x 1 1/8"  
 69127-03 8,9x3,8 cm 3 1/2" x 1 1/2"



MATHIEU  
 69130-19  
 19,5 cm, 7 3/4"



SCHULZE-BERGMANN  
 69142-06 - 69142-12

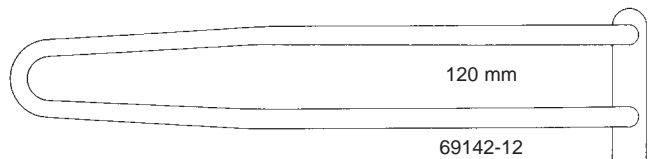
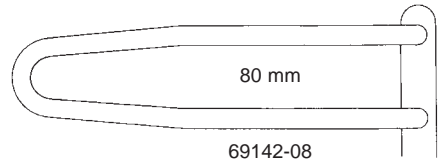
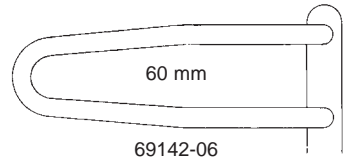

Analspreizer  
 Anal Retractors  
 Separadores rectales  
 Dilatatori per l'ano e il retto

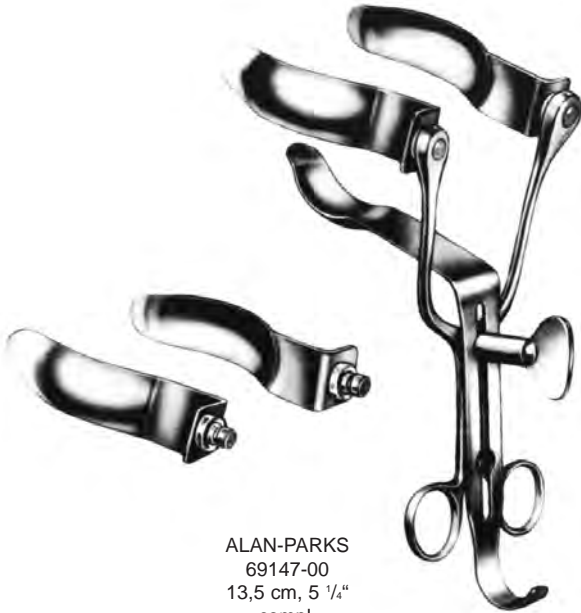

ALAN-PARKS  
 69147-00  
 13,5 cm, 5 1/4"  
 compl.

69148-00  
 Kaltlicht Zubehör für 69147-00  
 Cold Light Attachment for 69147-00  
 Adaptador para luz fría 69147-00  
 Adattatore luce fredda per 69147-00

- 69147-02 Mittelblatt allein  
 Center blade, only  
 Valva central, solo  
 Valva centrale, sola
- 69147-03 Blatt allein 75 mm, 3"  
 Blade only 75 mm, 3"  
 Valva sola 75 mm, 3"  
 Valva sola 75 mm, 3"
- 69147-04 Blatt allein 95 mm, 3 3/4"  
 Blade only 95 mm, 3 3/4"  
 Valva sola 95 mm, 3 3/4"  
 Valva sola 95 mm, 3 3/4"

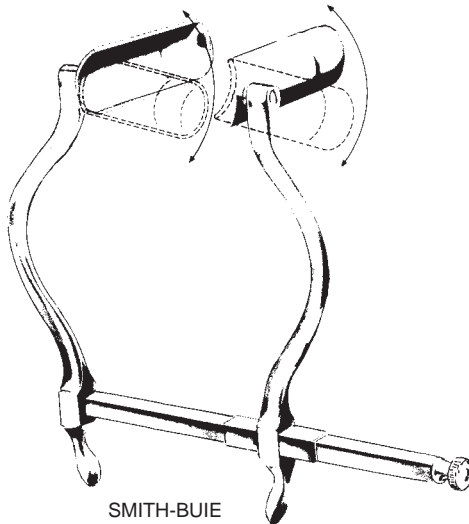

SMITH-BUIE  
 69150-15  
 15 cm, 6"  
 75x23 mm

Anuskope, Proktoskope  
 Anoscopes, Proctoscopes  
 Anoscopios, Proctoscopios  
 Anoscopi, Protoscopi

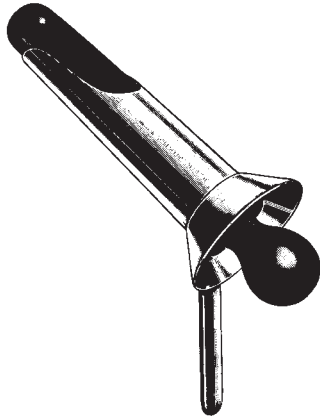

IVES-FANSLER  
 69210-22 22 mm Ø  
 L = 80 mm



Ø mm	HIRSCHMANN
16	69212-16
19	69212-19
22	69212-22
	L = 65 mm



mm	KELLY
ØxL	69220-05
22x 50	69220-10
22x100	69220-14
22x140	69220-20
22x200	

Anuskope, Proktoskope, Fistelsonde  
 Anoscopes, Proctoscopes, Fistula Probe  
 Anoscopios, Proctoscopios, Sondas para fistulas  
 Anoscopi, Proctoscopi, Sonde per fistole



Ø mm KELLY  
 21 69224-21  
 27 69224-27  
 L = 50 mm, 2"

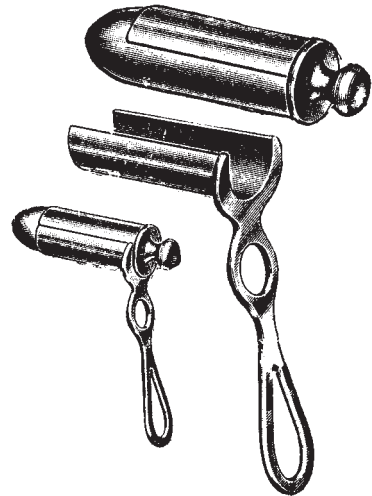

Ø mm CHELSEA-EATON  
 22 x 65 69225-22  
 30 x 65 69225-30



Fig. 1  
 69251-01

Fig. 2  
 69251-02

Fig. 3  
 69251-03

PRATT  
 21 cm, 8 1/4"  
 69251-01 - 69251-03

Proktoskope  
Proctoscopes  
Proctoscopios  
Protoscopi

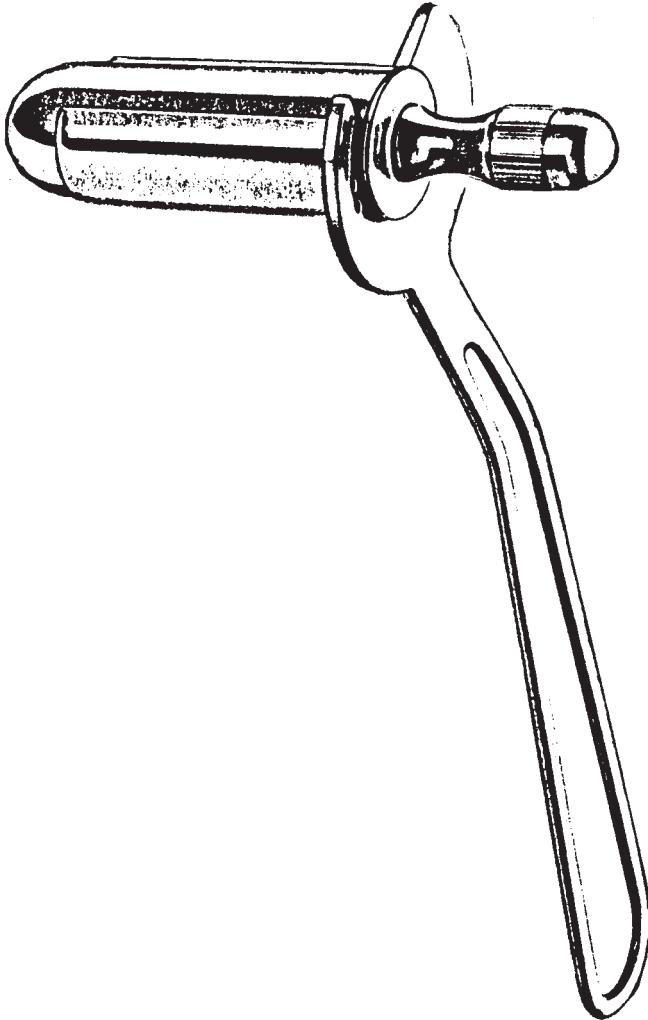

Ø	FANSLER, 24 cm, 9 1/2"
65 x 25 mm	69226-25
65 x 29 mm	69226-29
70 x 38 mm	69226-38

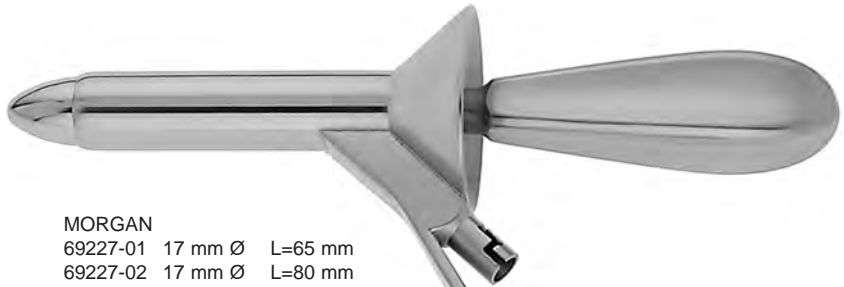

MORGAN

69227-01	17 mm Ø	L=65 mm
69227-02	17 mm Ø	L=80 mm
69227-03	20 mm Ø	L=65 mm
69227-04	20 mm Ø	L=80 mm
69227-05	24 mm Ø	L=65 mm
69227-06	24 mm Ø	L=80 mm

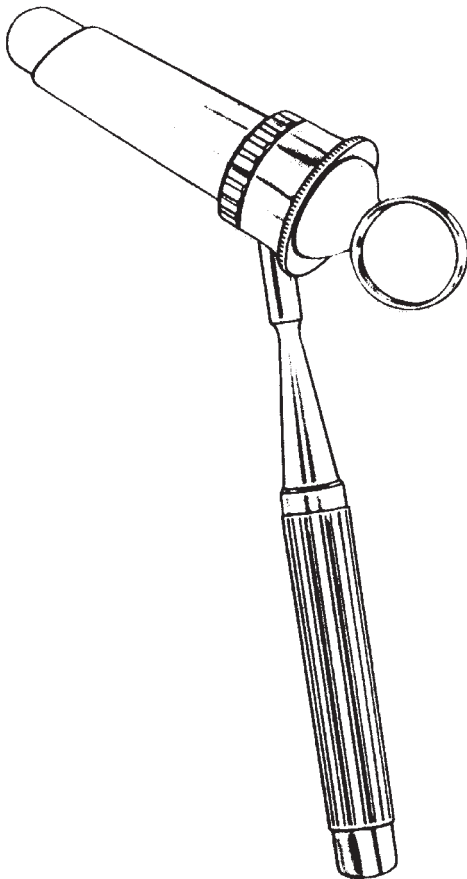

69228-01

Beleuchtungsstab für Morgan  
 Illumination attachment for Morgan  
 Mango con iluminacion para Morgan  
 Dispositivo Illuminativo per Morgan

BENSAUDE

69229-01	19 mm Ø	L=70 mm
69229-02	22 mm Ø	L=70 mm



Rektal Absaugrohr, Rektalschnürer, Mastdarmbiopsiezangen  
 Rectal aspiration cannula, Rectal snare, Rectal Biopsy Specimen Forceps  
 Cánula de aspiración rectal, Cierra-nudo rectal, Pinzas para biopsia rectal  
 Cannula d'aspirazione rettale, Serranodi, Pinze taglianti per biopsia rettale

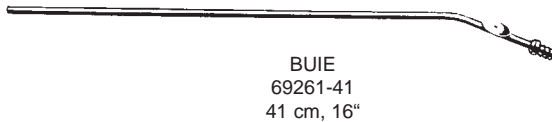

BUIE  
 69261-41  
 41 cm, 16"

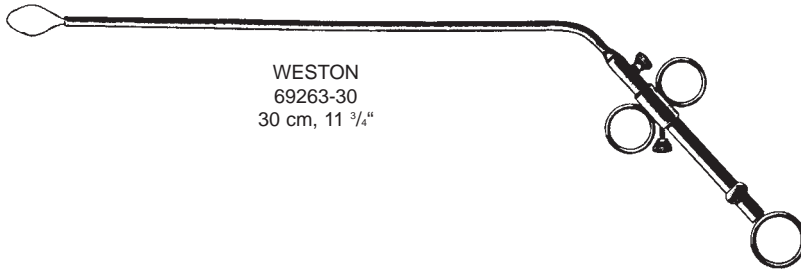

WESTON  
 69263-30  
 30 cm, 11 3/4"

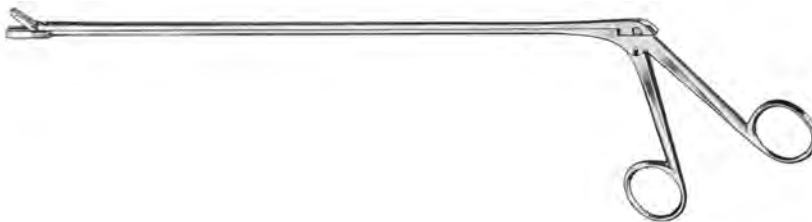

YEOMAN  
 69301-28 - 69304-42

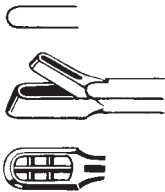

Fig. 1  
 69301-28 28 cm, 11"  
 69301-35 35 cm, 13 3/4"  
 69301-42 42 cm, 16 1/2"

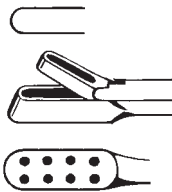

Fig. 2  
 69302-28 28 cm, 11"  
 69302-35 35 cm, 13 3/4"  
 69302-42 42 cm, 16 1/2"

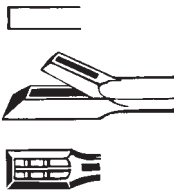

Fig. 3  
 69303-28 28 cm, 11"  
 69303-35 35 cm, 13 3/4"  
 69303-42 42 cm, 16 1/2"

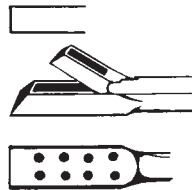
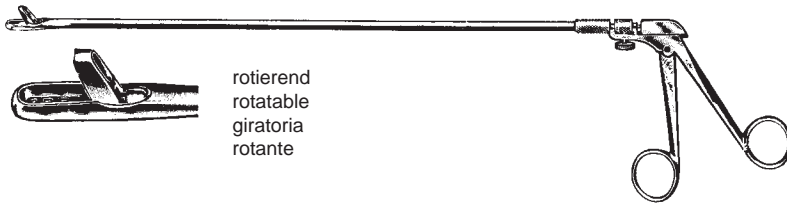

Fig. 4  
 69304-28 28 cm, 11"  
 69304-35 35 cm, 13 3/4"  
 69304-42 42 cm, 16 1/2"

Mastdarm-Biopsiezangen rotierend, Hämorrhoidalzange  
 Rectal Biopsy Specimen Forceps rotatable, Haemorrhoidal Forceps  
 Pinzas para biopsia rectal, giratoria, Pinzas-clamps hemorroidales  
 Pinze taglianti per biopsia rettale, rotante, Pinze per emorroidi



rotierend  
 rotatable  
 giratoria  
 rotante

YEOMANN

69311-23 23 cm, 9"  
 69311-33 33 cm, 13"  
 69311-40 40 cm, 15 3/4"

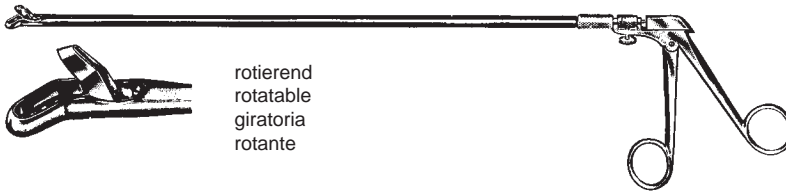

rotierend  
 rotatable  
 giratoria  
 rotante

TURREL

69321-23 23 cm, 9"  
 69321-33 33 cm, 13"  
 69321-40 40 cm, 15 3/4"

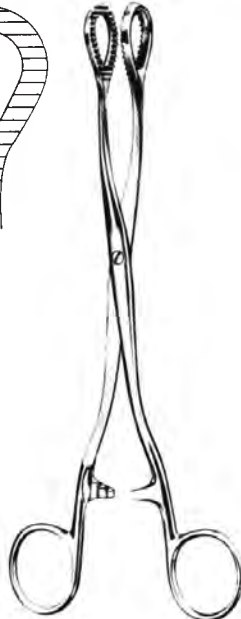
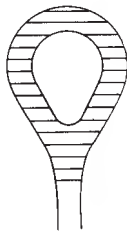

HEYWOOD-SMITH

69402-21 21 cm, 8 1/4"  
 69402-25 25 cm, 10"

Hämorrhoidal-Ligatoren, Hämorrhoidalzangen  
 Haemorrhoidal Ligators, Haemorrhoidal Forceps  
 Ligadores para hemorroides, Pinzas-clamps para hemorroides  
 Legatori emorroidali, Pinze per emorroidi

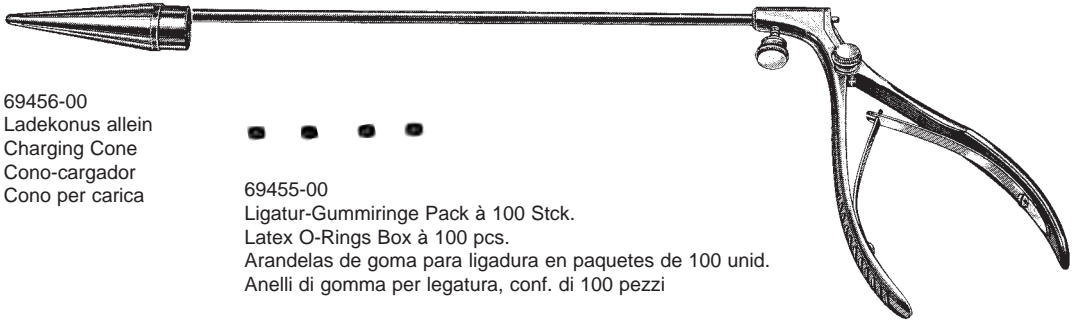

69456-00  
 Ladekonus allein  
 Charging Cone  
 Cono-cargador  
 Cono per carica



69455-00  
 Ligatur-Gummiringe Pack à 100 Stck.  
 Latex O-Rings Box à 100 pcs.  
 Arandelas de goma para ligadura en paquetes de 100 unid.  
 Anelli di gomma per legatura, conf. di 100 pezzi

MC GIVNEY  
 LI GATOR  
 69450-18  
 18 cm, 7"

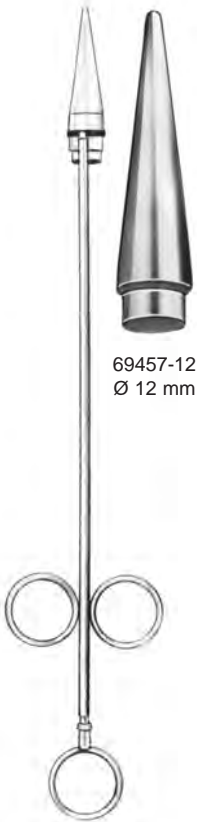

69457-12  
 Ø 12 mm

RUDD  
 69457-31  
 31,5 cm, 12 1/2"  
 kplt./cplt.

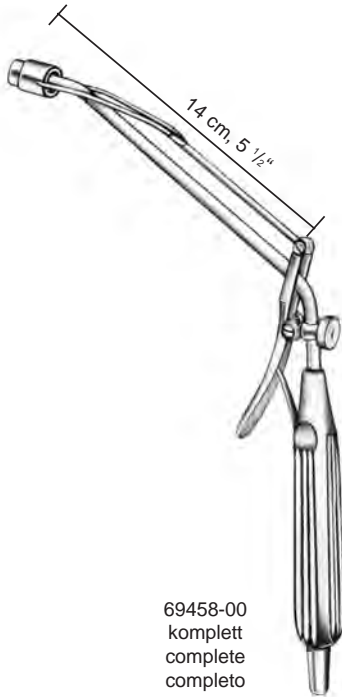

69458-00  
 komplett  
 complete  
 completo



Ø 10 mm  
 69458-10  
 Ladekonus  
 Charging cone  
 Cono-cargador  
 Cono per carica



Ø 10 mm  
 69458-11 11 mm  
 69458-16 16 mm  
 Saugkopf  
 Aspiration tip  
 Cabeza de aspiración  
 Testa d'aspirazione

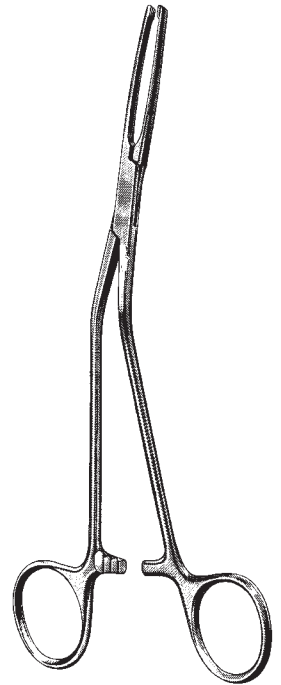

MC GIVNEY  
 69460-00  
 19 cm, 7 1/2"

Lateral-Scheidenspekula  
 Lateral Vaginal Retractor  
 Espécúlos vaginales  
 Specoli vaginali



71100-00

Lateralspreizer allein  
 Vaginal retractor lateral only  
 Espécúlo vaginal solo  
 Specolo vaginale laterale, solo

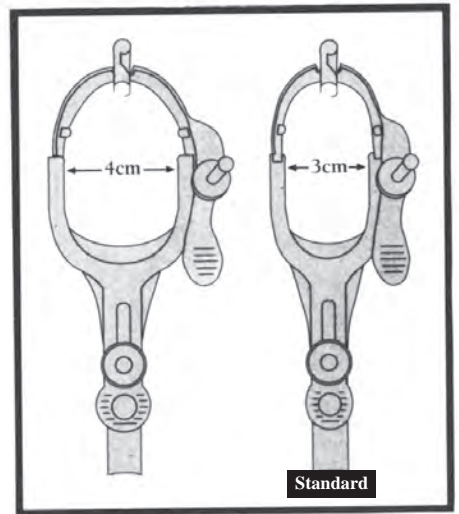

VU-MORE

Fig.	mm	
2	95x35	71115-02
3	115x35	71115-03

Scheidenspekula  
Vaginal Specula  
Espéculos vaginales  
Specoli vaginali

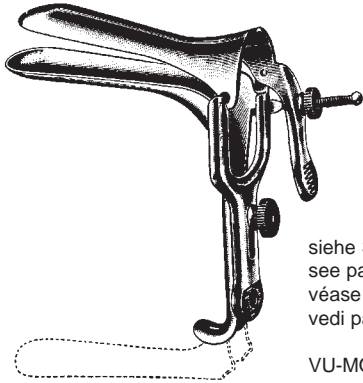

siehe Seite 569  
see page no. 569  
véase pagina no. 569  
vedi pagina nr. 569

VU-MORE

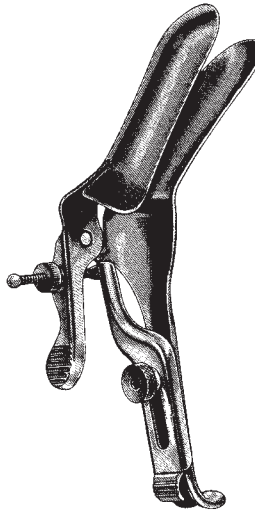

rechts offen  
open right-side  
abierto a la derecha  
aperta a destra

GRAVE  
71116-02

mittel, medium, mediano, medio  
101x35 mm

GRAVE

Fig.	mm	Standard
1	75x20	71110-01
2	95x35	71110-02
3	115x35	71110-03

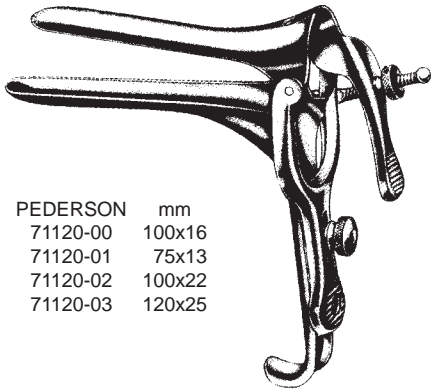

Fig.	PEDERSON	mm
	71120-00	100x16
1	71120-01	75x13
2	71120-02	100x22
3	71120-03	120x25

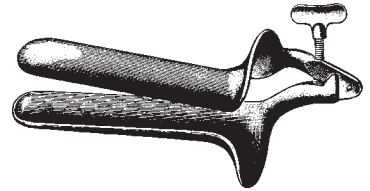
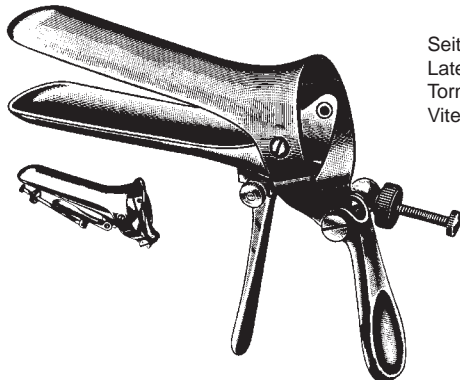

Fig.	COLLIN	mm
1	71130-01	85x30
2	71130-02	100x35
3	71130-03	110x40



Seitliche Schraube  
Lateral Screw  
Tornillo lateral  
Vite laterale

CUSCO

Fig.	mm	Standard
1	75x32	71140-01
2	85x35	71140-02
3	100x35	71140-03
4	75x17	71142-04

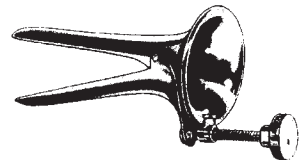

COLLIN  
71132-00  
65x10 mm

für Jungfrauen  
for virgin  
para vírgenes  
per vergini

Scheidenspekula  
 Vaginal Specula  
 Espécules vaginales  
 Specoli vaginali

Mittelschraube  
 Central Screw  
 Tornillo central  
 Vite centrale

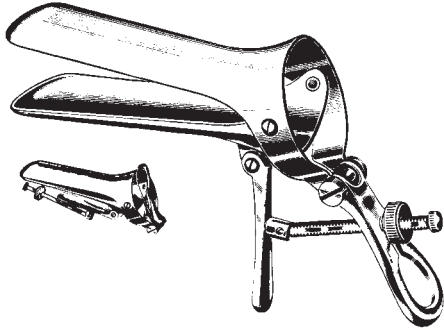

Fig.	CUSCO	mm
1	71150-01	75x32
2	71150-02	85x35
3	71150-03	100x37

Schweizer Modell  
 Swiss Pattern  
 Modelo suizo  
 Modello svizzero

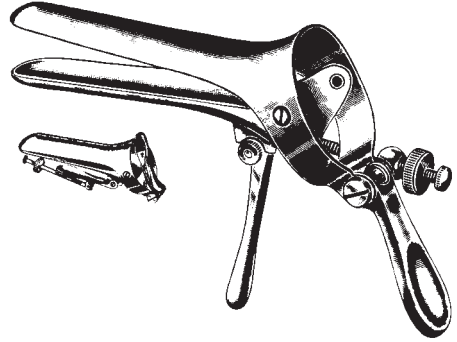
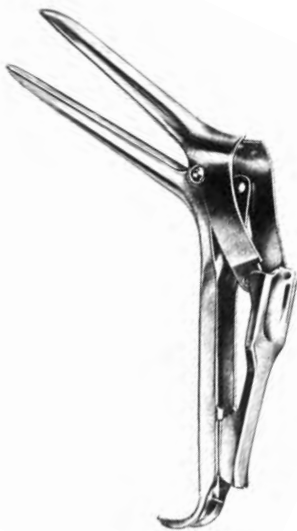

Fig.	CUSCO	mm
1	71160-01	90x23-25
2	71160-02	100x25-27
3	71160-03	110x27-30



	SEMM	mm
71161-17	100 x 17 - 20	mm
71161-25	100 x 25 - 30	mm

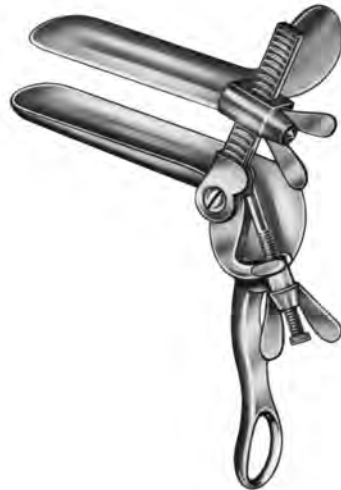

Fig.	TRÉLAT	mm
1	71170-01	85x33
2	71170-02	95x35
3	71170-03	115x43

Scheidenspekula  
 Vaginal Specula  
 Espéculos vaginales  
 Specoli vaginali

Satz bestehend aus je 1 Spekula und 1 Halter  
 Set consisting of 1 specula and 1 retractor  
 Juego de 1 espéculo y 1 valva  
 Serie da 1 specolo e 1 valva

Spekula  
 Speculum  
 Espéculo  
 Specolo

Halter  
 Retractor  
 Valva  
 Valve



Fig. KRISTELLER  
 1 71210-01  
 2 71210-02  
 3 71210-03

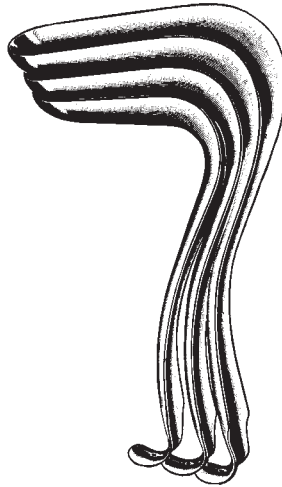

Fig. KRISTELLER mm  
 1 71211-01 70x27  
 2 71211-02 80x30  
 3 71211-03 90x36



Fig. KRISTELLER mm  
 1 71212-01 75x23  
 2 71212-02 85x26  
 3 71212-03 100x32



Fig. KRISTELLER  
 00 71240-00  
 0 71240-10  
 1 71240-01  
 2 71240-02  
 3 71240-03

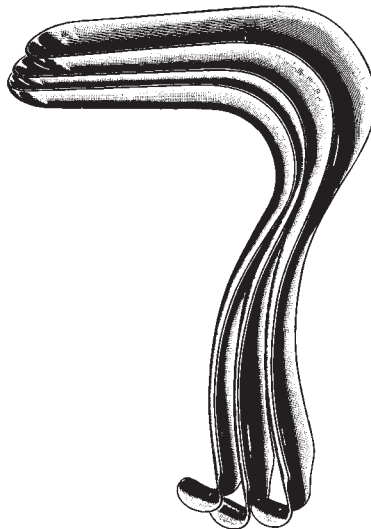

Fig. KRISTELLER mm  
 00 71241-00 110x18  
 0 71241-10 110x21  
 1 71241-01 110x27  
 2 71241-02 110x30  
 3 71241-03 110x36

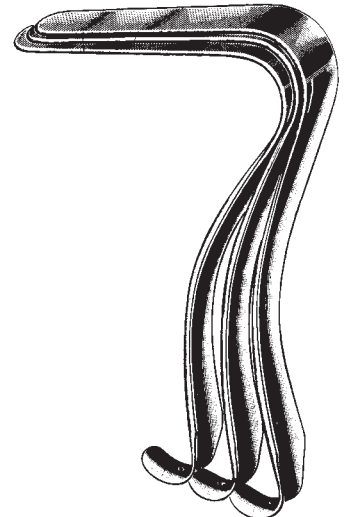

Fig. KRISTELLER mm  
 00 71242-00 115x14  
 0 71242-10 115x17  
 1 71242-01 115x23  
 2 71242-02 115x26  
 3 71242-03 115x32

Scheidenspekula  
Vaginal Specula  
Espéculos vaginales  
Specoli vaginali



KALLMORGEN  
71260-01 - 71262-02

Fig.	Satz Set Juego Serie	Spekula Speculum Espéculo Specolo	Halter Retractor Valva	mm	Valve	mm
1	71260-01	71261-01	70x40	71262-01	70x33	
2	71260-02	71261-02	90x40	71262-02	90x33	

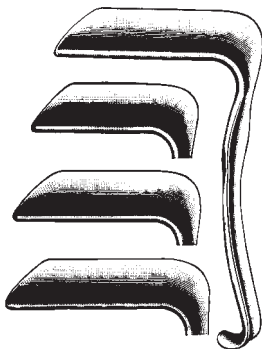

JACKSON

Fig.	mm	mm
1	71271-01	75x38
2	71271-02	90x38
3	71271-03	100x38



SIMS

Fig.	mm	mm
1	71281-01	63x32
2	71281-02	76x32
3	71281-03	89x38

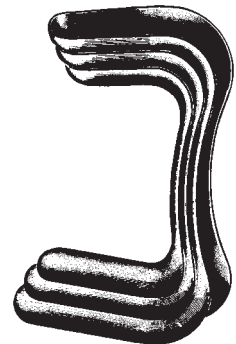

SIMS

Fig.	mm	mm
1	71291-01	60x25+30
2	71291-02	70x30+35
3	71291-03	80x35+40

Set 71291-00 (Fig. 1,2,3)



Scheidenspekula  
 Vaginal Specula  
 Espéculos vaginales  
 Specoli vaginali



DELEE  
 71300-01  
 23,5 cm, 9 1/4"

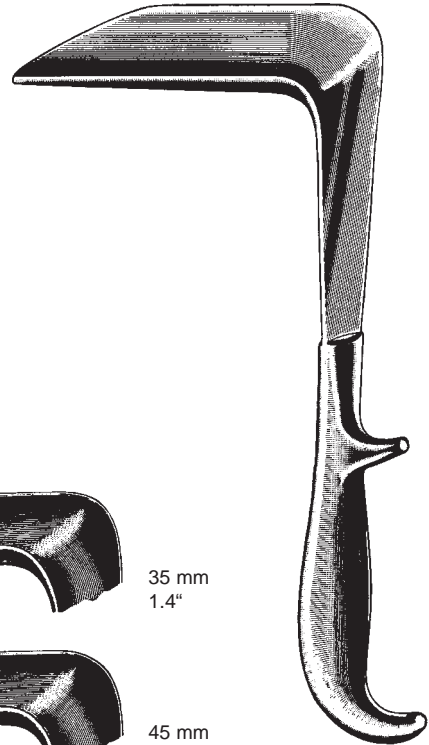

DOYEN  
 24 cm, 9 1/2"

leicht hohl  
 slightly concave  
 ligeramente concavos  
 leggermente concavi

Fig.		mm
1	71301-01	55x35
2	71301-02	85x35
3	71301-03	115x35



35 mm  
 1.4"

Fig.		mm
1	71303-01	55x45
2	71303-02	85x45
3	71303-03	115x45
4	71303-04	160x45
5	71303-05	180x45



45 mm  
 1.8"

Fig.		mm
1	71305-01	55x60
2	71305-02	85x60
3	71305-03	115x60
4	71305-04	160x60
5	71305-05	180x60



60 mm  
 2.4"

Scheidenspekula  
 Vaginal Specula  
 Espéculos vaginales  
 Specoli vaginali

71306-01  
 80 x 30 mm

71306-02  
 85 x 35 mm

71306-03  
 90 x 40 mm



71306-01 - 71306-03

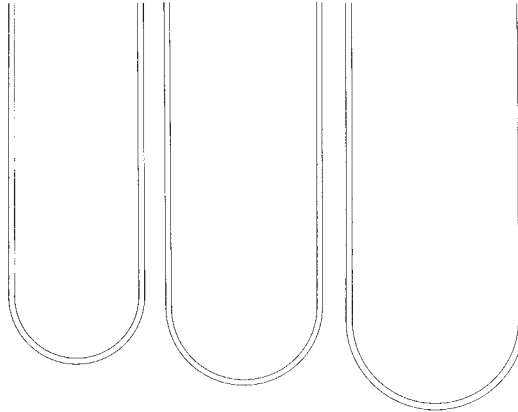

71306-04  
 Gewicht 400 gr  
 weight 400 grs  
 peso 400 grs  
 peso 400 grs

71306-05  
 Gewicht 800 gr  
 weight 800 grs  
 peso 800 grs  
 peso 800 grs

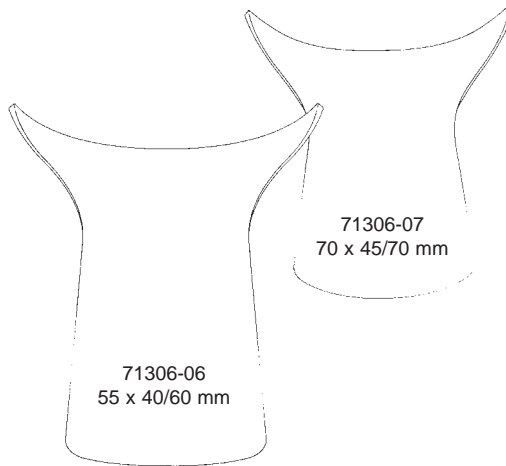

71306-06  
 55 x 40/60 mm

71306-07  
 70 x 45/70 mm

SCHERBAK  
 71306-00  
 Set komplett  
 complete set  
 juego completo  
 set completo



71306-08  
 Griff, handle,  
 mango, manico

Scheidenspekula  
 Vaginal Specula  
 Espécúlos vaginales  
 Specoli vaginali



71308-00

komplett bestehend aus:  
 1 Rahmen mit 2 beweglichen Seitenvalven  
 3 austauschbare Mittelvalven Fig. 1-3

1 frame with 2 mobile lateral blades  
 3 interchangeable blades Fig. 1-3

1 Marco con 2 separadores móviles laterales  
 3 separadores centrales intercambiables fig. 1-3

1 telaio regolabile con 2 valve laterali mobili  
 3 valve intercambiabili fig. 1-3

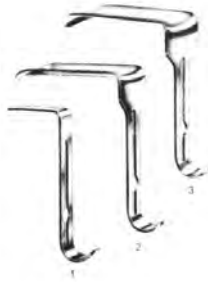

O'SULLIVAN-O'CONNOR  
 71308-00

Fig. 1 = 45 x 17 mm 71308-01  
 Fig. 2 = 90 x 37 mm 71308-02  
 Fig. 3 = 90 x 45 mm 71308-03

71308-04  
 Rahmen allein  
 Frame only  
 Marco solo  
 Telaio solo

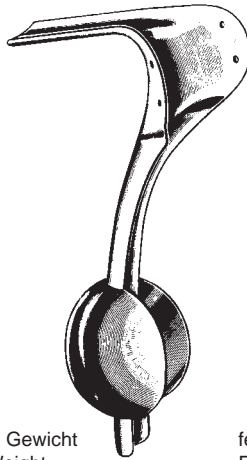

abnehmbares Gewicht  
 Detachable Weight  
 Peso desmontable  
 Peso smontabile

festes Gewicht  
 Fixed Weight  
 Peso fijo  
 Peso fisso

71307-00  
 1,4 kg  
 75 x 38 mm

AUVARD  
 24 cm, 9 1/2"

71309-00  
 1,4 kg  
 105 x 38 mm

Scheidenspekula, Endospekula  
 Vaginal Specula, Endospecula  
 Espéculos vaginales, Endo-espéculos  
 Specoli vaginali, Endospecoli



mm	BREISKY	
100x20	71310-20	28 cm, 11"
100x25	71310-25	28 cm, 11"
100x30	71310-30	28 cm, 11"
100x35	71310-35	28 cm, 11"
100x40	71310-40	28 cm, 11"
130x20	71313-20	33 cm, 13"
130x25	71313-25	33 cm, 13"
130x30	71313-30	33 cm, 13"
130x35	71313-35	33 cm, 13"
130x40	71313-40	33 cm, 13"
155x40	71315-40	35 cm, 13 3/4"



mm	LANDAU	
100x28	71319-28	29 cm, 11 1/2"
100x38	71319-38	29 cm, 11 1/2"

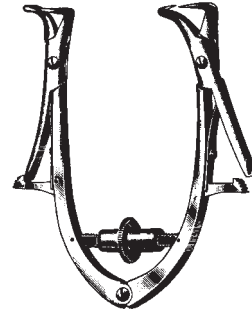

FRIEDMANN	
71351-15	15 cm, 6"

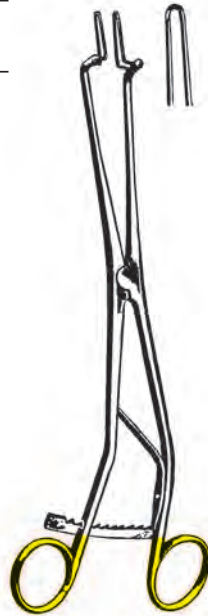

KOGAN		
71360-24	3 mm	24 cm, 9 1/2"
71361-24	4 mm	24 cm, 9 1/2"
71362-24	5 mm	24 cm, 9 1/2"



KOGAN		
71363-24	3 mm	24 cm, 9 1/2"
71364-24	4 mm	24 cm, 9 1/2"
71365-24	5 mm	24 cm, 9 1/2"

Uterus Dilatatore  
 Uterine Dilators  
 Dilataores uterinos  
 Dilatatori uterini

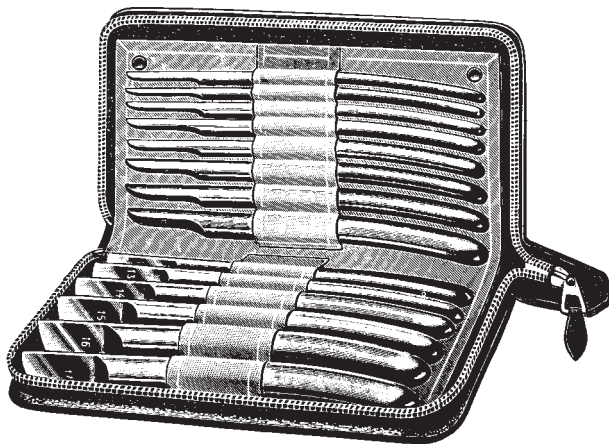

HEGAR  
 71405-14 4-17 mm  
 14 St./pces./pzas./pezzi

mm Ø	HEGAR		mm Ø
1	71410-01	71415-01	1,5
2	71410-02	71415-02	2,5
3	71410-03	71415-03	3,5
4	71410-04	71415-04	4,5
5	71410-05	71415-05	5,5
6	71410-06	71415-06	6,5
7	71410-07	71415-07	7,5
8	71410-08	71415-08	8,5
9	71410-09	71415-09	9,5
10	71410-10	71415-10	10,5
11	71410-11	71415-11	11,5
12	71410-12	71415-12	12,5
13	71410-13	71415-13	13,5
14	71410-14	71415-14	14,5
15	71410-15	71415-15	15,5
16	71410-16	71415-16	16,5
17	71410-17	71415-17	17,5
18	71410-18	71415-18	18,5
19	71410-19	71415-19	19,5
20	71410-20		
21	71410-21		
22	71410-22		
23	71410-23		
24	71410-24		
25	71410-25		
26	71410-26		
27	71410-27		
28	71410-28		
29	71410-29		
30	71410-30		

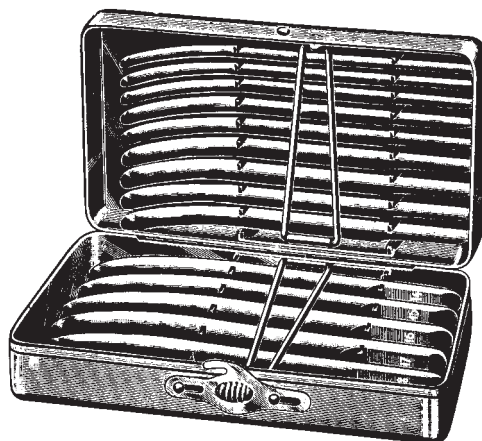

mm HEGAR  
 4-17 71406-14 14 St./pces./pzas./pezzi  
 1-26 71406-26 26 St./pces./pzas./pezzi

71404-14 Satz/Set/Juego/Set  
 71410-04 - 71410-17 = 14  
 71404-26 Satz/Set/Juego/Set  
 71410-01 - 71410-26 = 26

in Metalletui, in metal case,  
 en estuche de metal, in astuccio metallico

Uterus Dilatatore  
 Uterine Dilators  
 Dilatadores uterinos  
 Dilatatori uterini

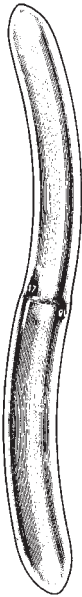

mm	HEGAR
1/ 2	71420-01
3/ 4	71420-03
5/ 6	71420-05
7/ 8	71420-07
9/10	71420-09
11/12	71420-11
13/14	71420-13
15/16	71420-15
17/18	71420-17
19/20	71420-19
21/22	71420-21
23/24	71420-23
25/26	71420-25

71424-08 Satz/Set/Juego/Set  
 71420-03 - 71420-17 = 8  
 3/4 - 17/18 mm

71424-13 Satz/Set/Juego/Set  
 71420-01 - 71420-25 = 13  
 1/2 - 25/26 mm

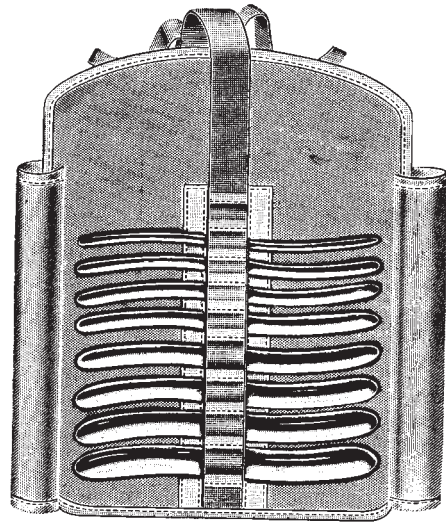

mm HEGAR  
 3/4 - 17/18 71425-08 8 St./pces./pzas./pezzi

in Stofftasche, in khaki roll,  
 en bolsa de tela, in borsa di tela

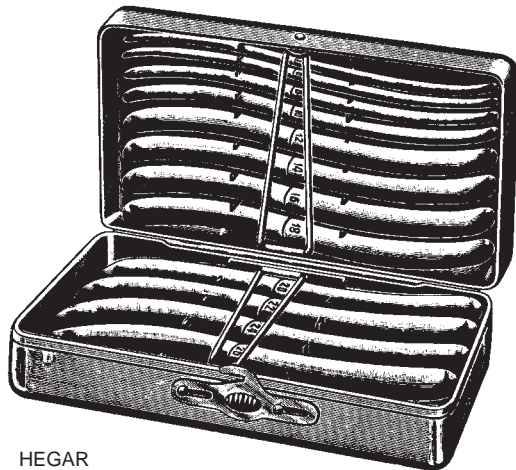

mm HEGAR  
 3-4 - 17/18 71426-08 8 St./pces./pzas./pezzi  
 1/2 - 25/26 71426-13 13 St./pces./pzas./pezzi

in Metalletui, in metal case,  
 en estuche de metal, in astuccio metallico

Uterus Dilatatore  
 Uterine Dilators  
 Dilatadores uterinos  
 Dilatatori uterini

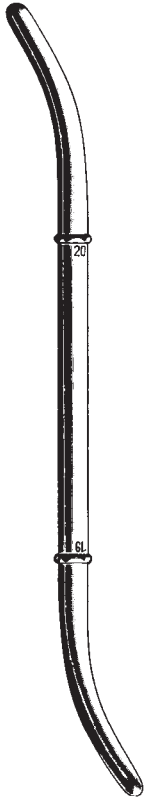

in Stofftasche  
 in khaki roll  
 en bolsa de tela  
 in borsa di tela

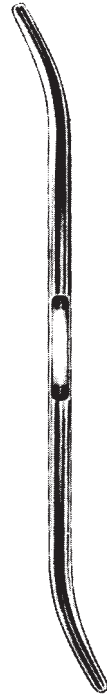
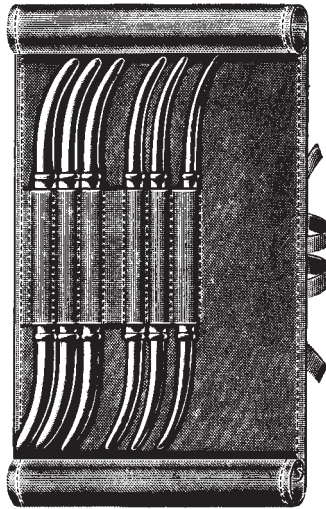

mm	HANK	Fig./U.S.
4,5/ 5	71430-10	9/10
5,5/ 6	71430-12	11/12
6,5/ 7	71430-14	13/14
7,5/ 8	71430-16	15/16
8,5/ 9	71430-18	17/18
9,5/10	71430-20	19/20

71435-06 Satz, Set, Juego, Serie = 6

HANK  
 71436-08  
 Satz, Set, Juego, Serie = 6

PRATT		
71438-13 - 71438-41		
71438-00		
Satz, Set, Juego, Set = 8	size	mm
71438-13	13-15	4,5/ 5,0
71438-17	17-19	5,6/ 6,3
71438-21	21-23	7,0/ 7,6
71438-25	25-27	8,3/ 9,0
71438-29	29-32	9,6/10,3
71438-33	33-35	11,0/11,6
71438-37	37-39	12,3/13,0
71438-41	41-43	13,6/14,3

Uterus Dilatatore  
Uterine Dilators  
Dilatadores uterinos  
Dilatatori uterini

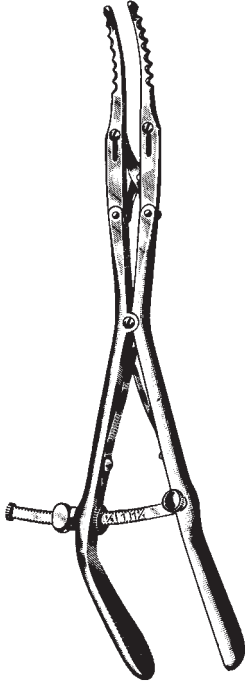

GOODELL  
71441-34  
34 cm, 13 1/2"

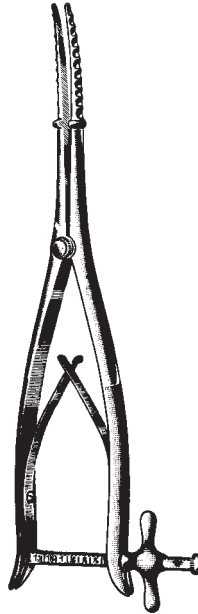

WYLIE  
71443-29  
29 cm, 11 1/2"

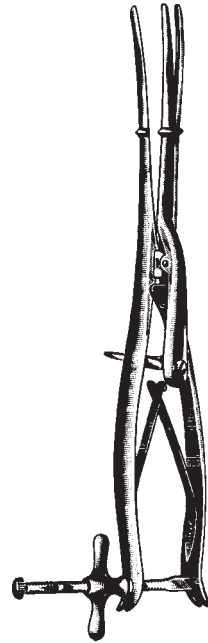

SIMS  
71445-29  
29 cm, 11 1/2"



Hakenzangen  
Tenaculum Forceps  
Pinzas para coger el cuello del útero  
Pinze per abbassare il collo dell'utero

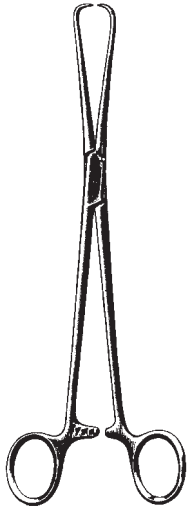

SCHRÖDER (POZZI)  
71502-25  
25 cm, 10"

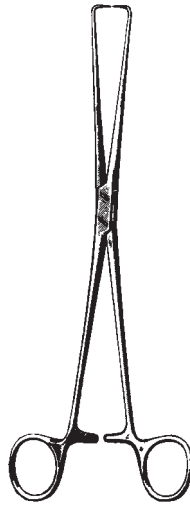

BRAUN  
71504-25  
25 cm, 10"



SKENE  
71505-24  
24 cm, 9 1/2"

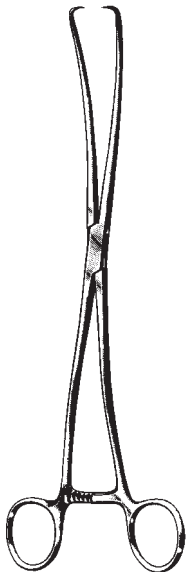

DUPLAY  
71507-28  
28 cm, 11"

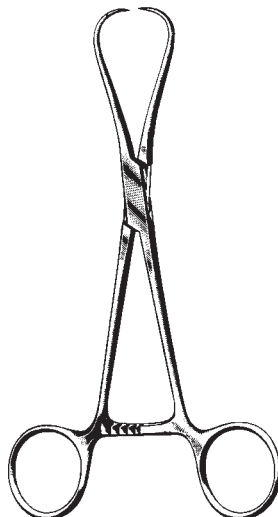

STAUDE-MOORE  
71508-17  
17 cm, 6 3/4"

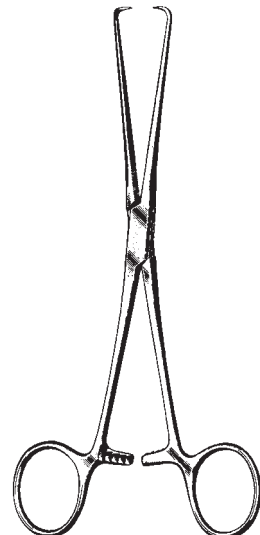

BARRETT  
71510-18  
18 cm, 7"

Hakenzangen  
 Tenaculum Forceps, Vulsellum Forceps  
 Pinzas para coger el cuello del útero  
 Pinze per abbassare il collo dell'utero

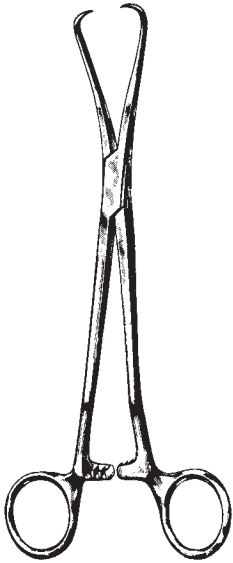

JARCHO  
 71512-20  
 20 cm, 8"

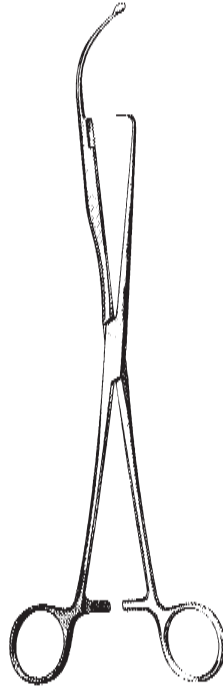

HULKA  
 71512-28  
 28 cm, 11"

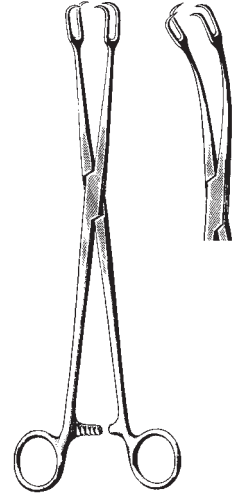

SCHRÖDER  
 71514-24 71515-24  
 24 cm, 9 1/2"

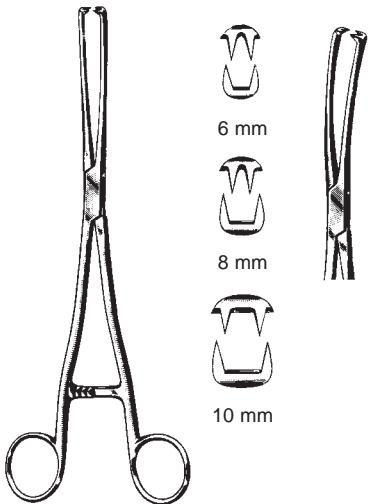

MUSEUX  
 71524-06 6 mm 71525-06  
 71524-08 8 mm 71525-08  
 71524-10 10 mm 71525-10  
 24 cm, 9 1/2"

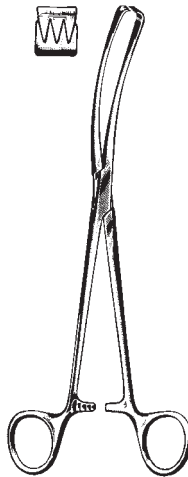

TEALE  
 71531-23  
 23 cm, 9"

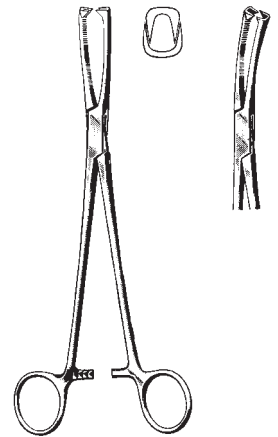

JACOBS  
 71532-21 71533-21  
 21 cm, 8 1/4"

Hakenzangen  
Tenaculum Forceps, Vulsellum Forceps  
Pinzas para coger el cuello del útero  
Pinze per abbassare il collo dell'utero

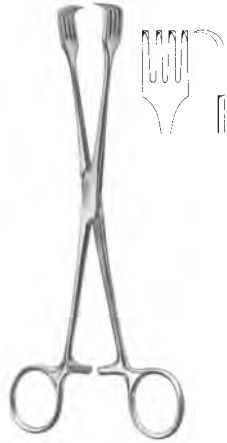

CZERNY  
71536-21  
20 cm, 8"



PRATT  
71536-28  
28 cm, 11"



SCHRÖDER  
71537-27  
27 cm, 10 1/2"

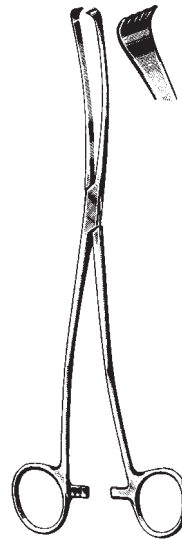

IOWA  
71539-26  
26 cm, 10 1/4"

Uterus Polypenzangen, Uterus-Faßzangen  
 Uterine Polypus Forceps, Uterine Elevating Forceps  
 Pinzas para pólipos uterinos, Pinzas para el útero  
 Pinze per polipi uterini, Pinze per afferrare l'utero

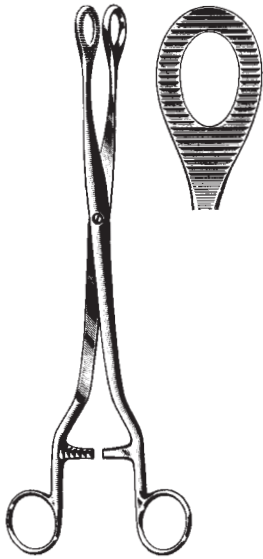

NOTO  
 71540-27  
 27 cm, 10 1/2"



DOYEN  
 71542-20  
 20 cm, 8"

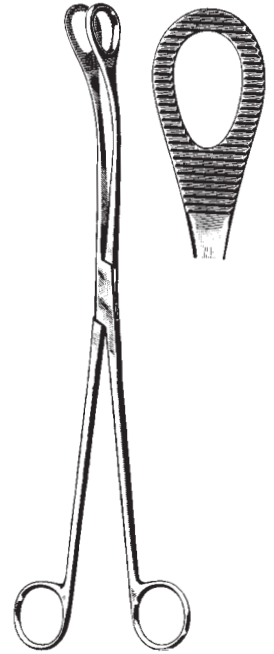

KELLY  
 71543-32  
 32 cm, 12 3/4"



DARTIGUES  
 71545-27  
 27 cm, 10 1/2"

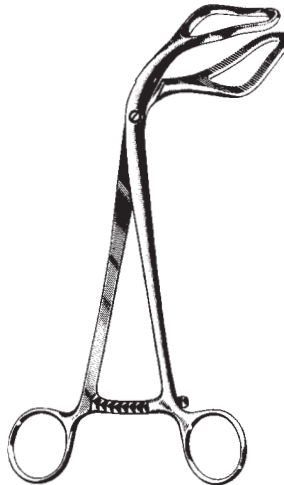

SOMER  
 71547-23  
 23 cm, 9"

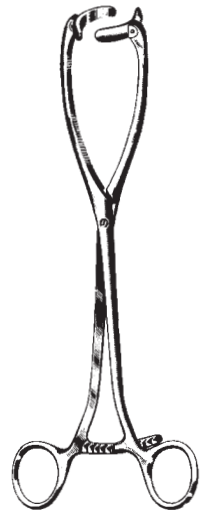

COLLIN  
 71549-25  
 25 cm, 10"

Amniotom, Uterus Depressoren, Uterus-Sonden  
 Amniotome, Uterine Depressors, Uterine Sounds  
 Amniótomo, Depresores uterinos, Histerómetros  
 Amniotomo, Depressori uterini, Isterometri



BEACHAM  
 71559-26  
 26 cm, 10 1/4"



BRAUN  
 71565-28  
 28 cm, 11"

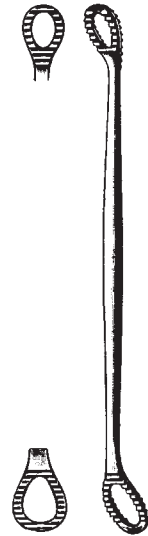

SIMS  
 71567-26  
 26 cm, 10 1/4"



fest  
 rigid  
 rigido  
 rigida  
 71580-32

SIMS  
 32 cm, 12 3/4"

biegsam  
 malleable  
 maleable  
 malleabile  
 71581-32



fest  
 rigid  
 rigido  
 rigida  
 71582-32

MARTIN  
 32 cm, 12 3/4"

biegsam  
 malleable  
 maleable  
 malleabile  
 71583-32



COLLIN  
 71584-28  
 28 cm, 11"



VALLEIX  
 71585-25  
 25 cm, 10"

Biopsie-Küretten  
 Uterine Biopsy Aspirating Curettes  
 Curetas aspiradoras p. la biopsia uterina  
 Curette per biopsia



RANDALL  
 71590-04  
 24 cm, 9 1/2"  
 Ø 4 mm



NOVAK  
 71592-01 1 mm  
 71592-02 2 mm  
 71592-03 3 mm  
 71592-04 4 mm



HEANY  
 71593-00  
 22,5 cm, 9"



71594-40



71596-40



KEVORKIAN  
 4,0 mm  
 30 cm, 11 3/4"  
 ohne Korb  
 without basket  
 sin cesta  
 senza cestello  
 71594-40

mit Korb  
 with basket  
 con cesta  
 con cestello  
 71596-40

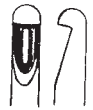

MOD. MUENCHEN  
 71598-27  
 27 cm, 10 1/2"

Biopsiezangen  
 Biopsy Forceps  
 Pinzas para biopsia  
 Pinze taglienti per biopsia

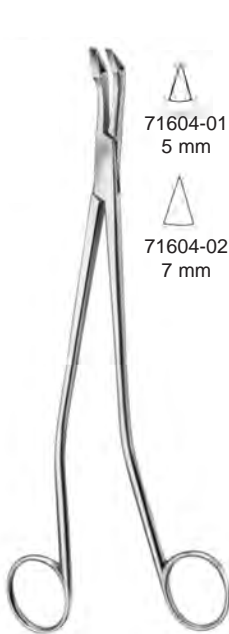

SCHUMACHER  
 24 cm, 9 1/2"



SCHUBERT  
 71604-21 21 cm, 8 1/4"  
 71604-28 28 cm, 11"

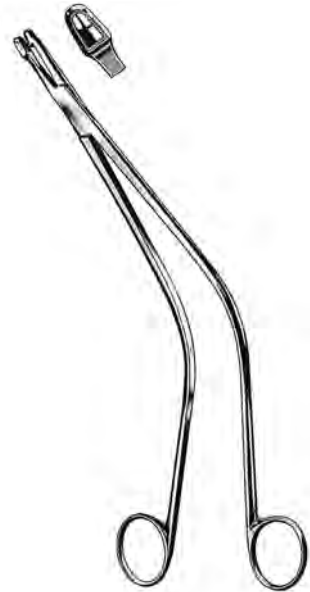

SCHUBERT  
 71605-26  
 26 cm, 10 1/4"



THOMAS-GAYLOR  
 71606-24  
 24 cm, 9 1/2"



van DOREN  
 71611-25  
 25 cm, 10"



FAURE  
 71612-21  
 21 cm, 8 1/4"

Uterus Biopsiezangen  
 Biopsy Specimen Forceps  
 Pinzas para biopsia  
 Pinze per biopsia

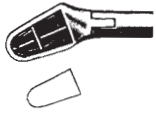

20 cm, 8"

ALEXANDER  
 71613-28  
 28 cm, 11"

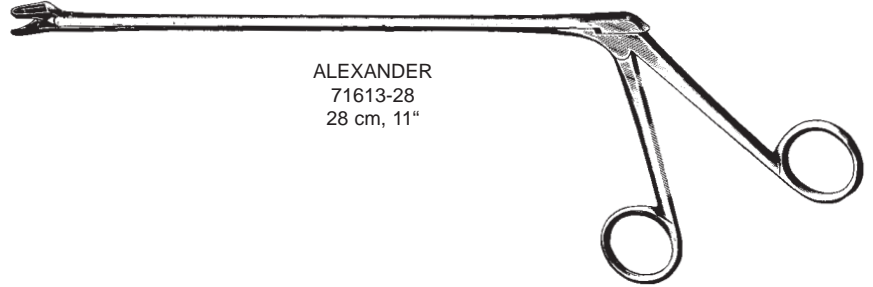

24 cm, 9 1/2"

SCHUMACHER  
 71615-01 - 71615-02  
 24 cm, 9 1/2"

71615-01  
 4 mm

71615-02  
 6 mm

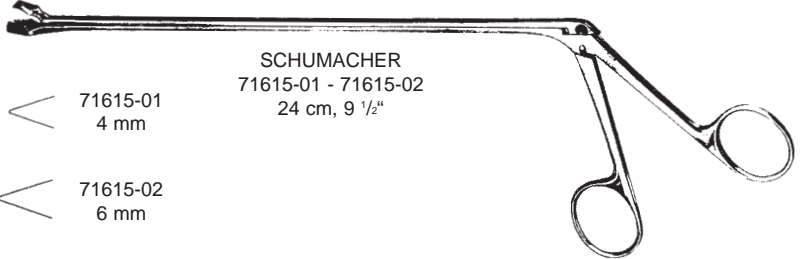

3x9,7 mm

24 cm, 9 1/2"

KEVORKIAN  
 71617-04  
 24,5 cm, 9 3/4"

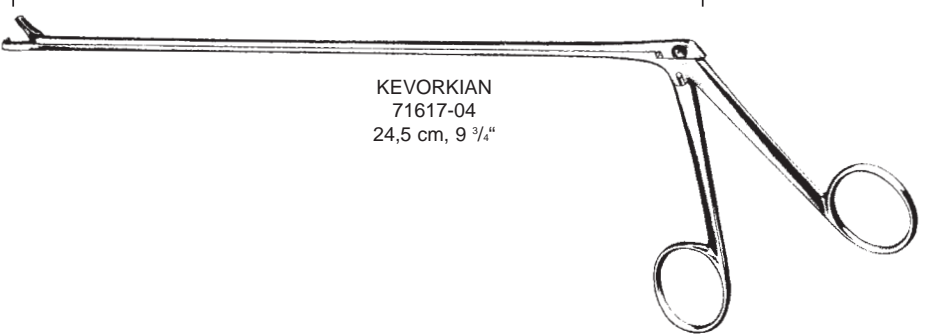

4x8 mm

23 cm, 9"

WITTNER  
 71618-23 71619-23  
 23 cm, 9"

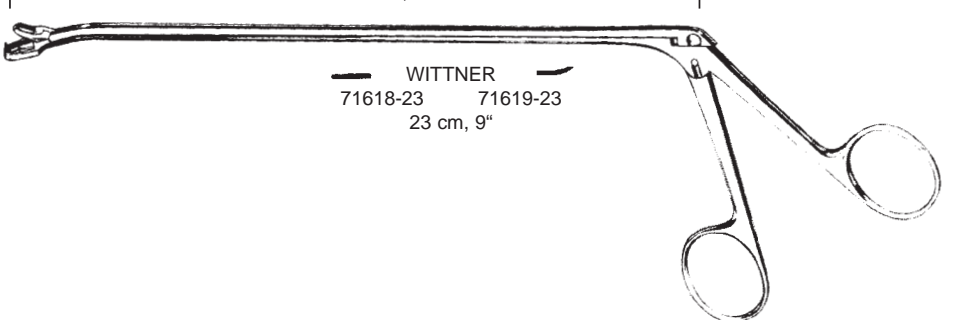



Uterus Biopsiezangen  
 Biopsy Specimen Forceps  
 Pinzas sacabocado p. biopsia  
 Pinze per biopsia

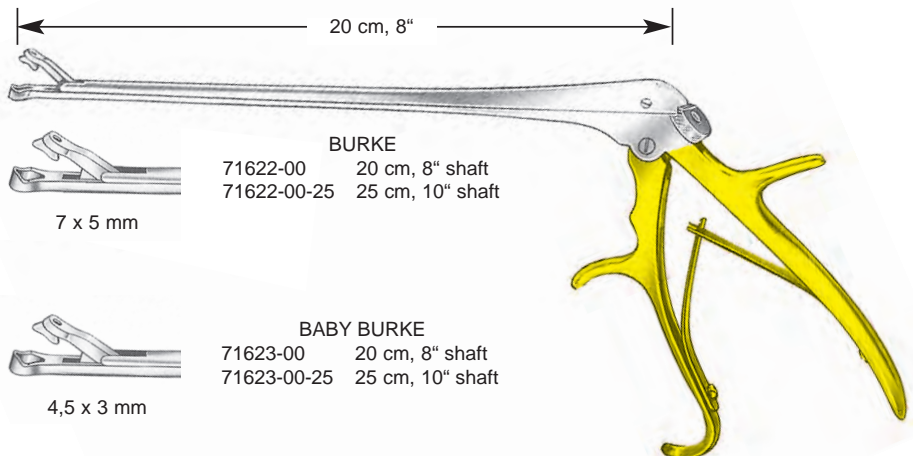
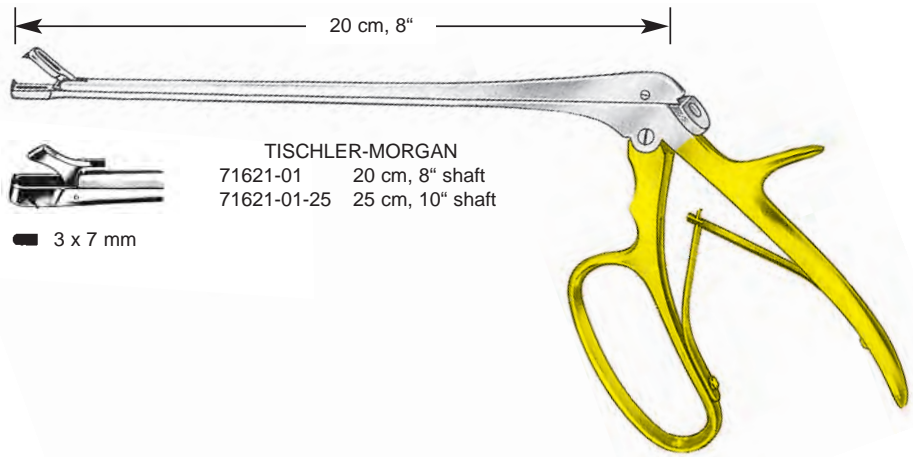
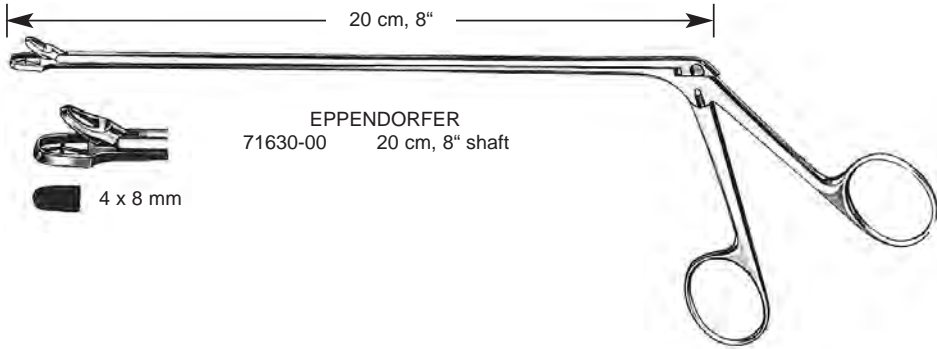

Uterus Biopsiezangen  
 Biopsy Specimen Forceps  
 Pinzas sacabocado p. biopsia  
 Pinze per biopsia

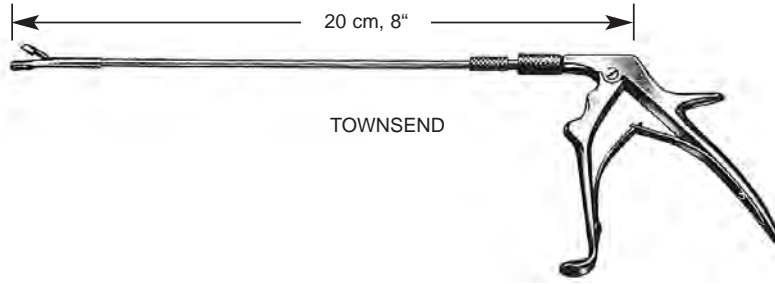

71624-10  
 Griff allein  
 Handle only  
 Mango solo  
 Manico solo



Fig. 1

TISCHLER-Morgan



Fig. 6

TISCHLER-UP



Fig. 3

oval ● 3,7x5 mm



Fig. 7

TISCHLER-DOWN



Fig. 4

KEVORKIAN



Fig. 8

MINI-TOWNSEND-UP



Fig. 5

mini



Fig. 9

MINI-TOWNSEND-DOWN

Fig.	Strumento completo	Asta operativa sola
1	71624-01	71624-11
3	71624-03	71624-13
4	71624-04	71624-14
5	71624-05	71624-15
6	71624-06	71624-16
7	71624-07	71624-17
8	71624-08	71624-18
9	71624-09	71624-19

komplett  
 compl. instr.  
 Instrum. compl.

Aufsatz allein  
 Tip only  
 Punta sola

Uterus Biopsiezangen  
Biopsy Specimen Forceps  
Pinzas sacabocado p. biopsia  
Pinze per biopsia



2,3 x 4,2 mm

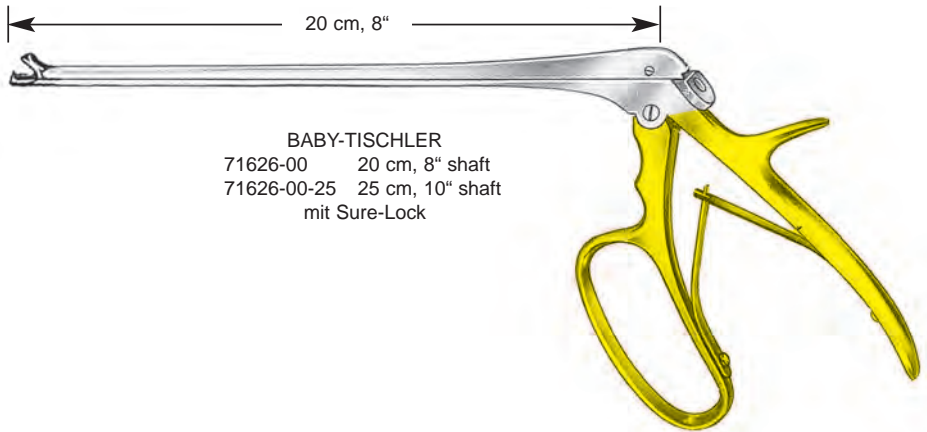

BABY-TISCHLER  
71626-00 20 cm, 8" shaft  
71626-00-25 25 cm, 10" shaft  
mit Sure-Lock



3 x 9,5 mm



TISCHLER-KEVORKIAN  
71627-00

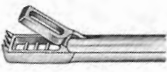

3 x 8 mm

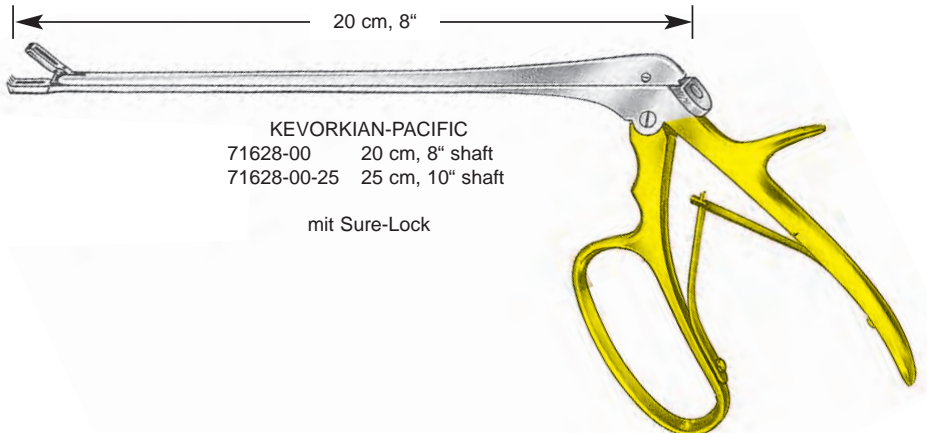

KEVORKIAN-PACIFIC  
71628-00 20 cm, 8" shaft  
71628-00-25 25 cm, 10" shaft  
mit Sure-Lock

Uterus Biopsiezangen  
Biopsy Specimen Forceps  
Pinzas sacabocado p. biopsia  
Pinze per biopsia

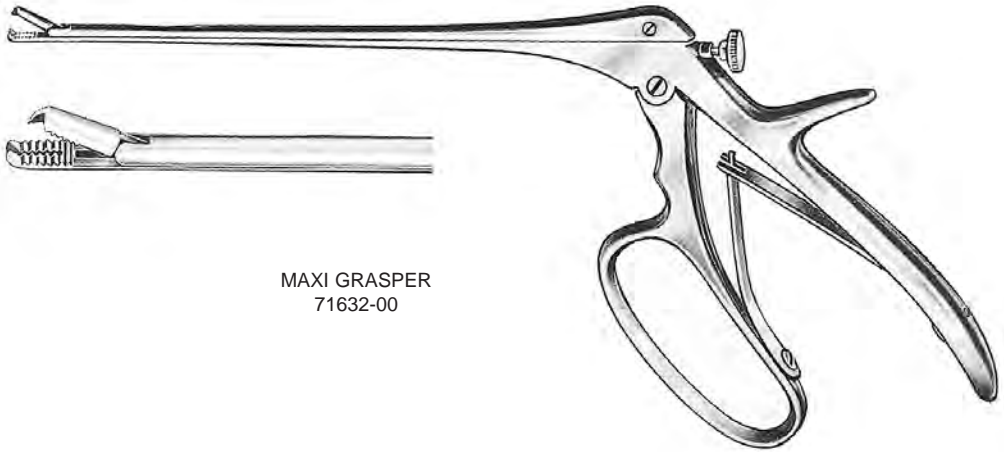

MAXI GRASPER  
71632-00

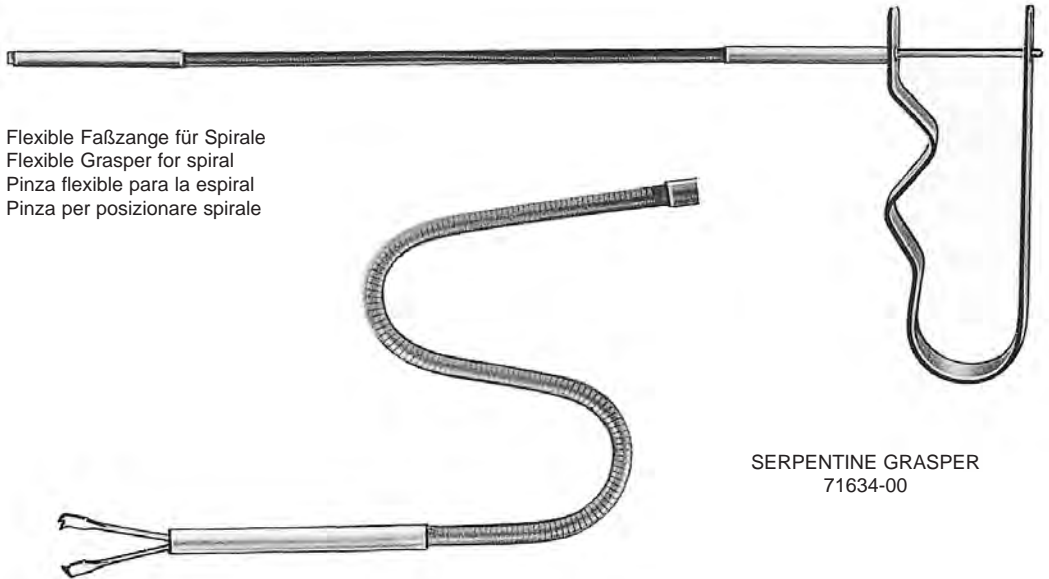

Flexible Faßzange für Spirale  
Flexible Grasper for spiral  
Pinza flexible para la espiral  
Pinza per posizionare spirale

SERPENTINE GRASPER  
71634-00



I.U.D.  
Extractor Hook  
71635-26  
26 cm, 10 1/4"

Myomheber, Myommesser, Fistelhäkchen, Meßinstrumente, Uteruslöffel  
 Myoma Screw, Myoma Knife, Fistula Hook, Measuring Instruments, Uterine Curettes  
 Tirabuzón para fibromas, Bisturi para fibromas, Ganchos para fistulas, Instrumental para medir, Curetas uterinas  
 Tiramiomi, Bisturi per fibromi, Uncini per fistole, Strumenti per misure, Curette uterine

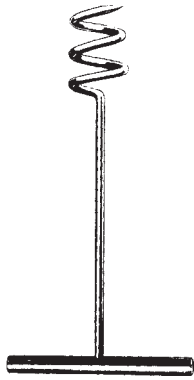

DOYEN  
 71641-17  
 17 cm, 6 3/4"

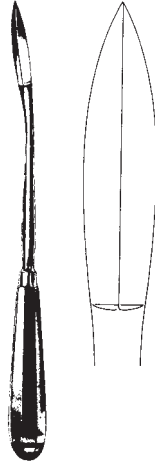

SEGOND  
 71643-27  
 27 cm, 10 1/2"

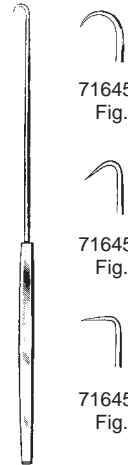

EMMET  
 71645-01 - 71645-03  
 22 cm, 8 3/4"

71645-01  
 Fig. 1

71645-02  
 Fig. 2

71645-03  
 Fig. 3

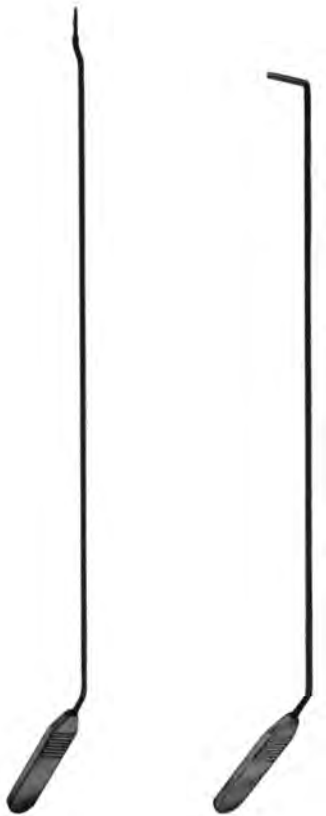

71646-01

71646-02

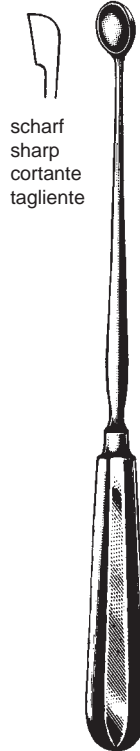

scharf  
 sharp  
 cortante  
 tagliente

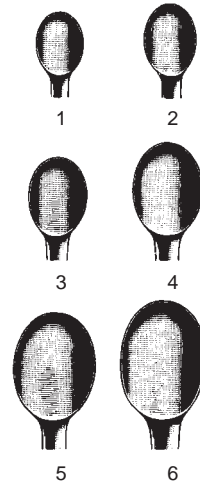

Fig. SIMON  
 1 71702-01 6,8 mm  
 2 71702-02 8,5 mm  
 3 71702-03 10,0 mm  
 4 71702-04 11,5 mm  
 5 71702-05 13,0 mm  
 6 71702-06 14,5 mm  
 25 cm, 10"

Uterus-Küretten  
Uterine Curettes  
Curetas uterinas  
Curette uterine



SCHRÖDER  
31 cm, 12 1/4"



71703-01  
6,8 mm



71703-02  
8,5 mm



71703-03  
10 mm



71703-04  
11,5 mm



71703-05  
13 mm



71703-06  
14,5 mm

scharf/stumpf  
sharp/blunt  
cortante/roma  
tagliante/smussa

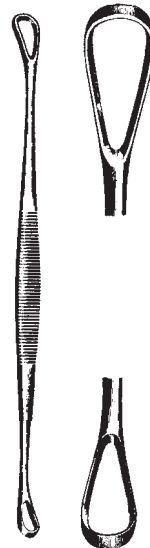

BLAKE  
71704-27  
27 cm, 10 1/2"

Salpingograph  
 Salpingograph  
 Salpingógrafo  
 Salpingografo

**71650-00**

Schultze Salpingograph  
 bestehend aus:

- 71650-01 1 Tubenkatheter
- 71650-02 1 Zwischenstück
- 71650-03 1 Manometer
- 71650-04 1 Kegel, klein
- 71650-05 1 Kegel, mittel
- 71650-06 1 Kegel, groß
- 71650-07 1 Recordspritze mit  
Luer-Lock-Ansatz 10cc

Salpingógrafo compuesto de:

- 71650-01 1 cateter de tubo
- 71650-02 1 pieza de conexion
- 71650-03 1 manometro
- 71650-04 1 cono pequeño
- 71650-05 1 cono mediano
- 71650-06 1 cono grande
- 71650-07 1 jeringa con  
conexion Luer-Lock 10cc

Salpingografo composto da:

- 71650-01 1 Catetere per tubo
- 71650-02 1 Raccordo
- 71650-03 1 Manometro
- 71650-04 1 Cono, piccolo
- 71650-05 1 Cono, medio
- 71650-06 1 Cono, grande
- 71650-07 1 Siringa record con  
Raccordo Luer-Lock 10cc

**71660-00**

Schultze Salpingograph, jedoch ohne  
 Manometer

Schultze Salpingograph without  
 manometer

Schultze Salpingografo sin manometro

Schultze Salpingografo senza  
 manometro

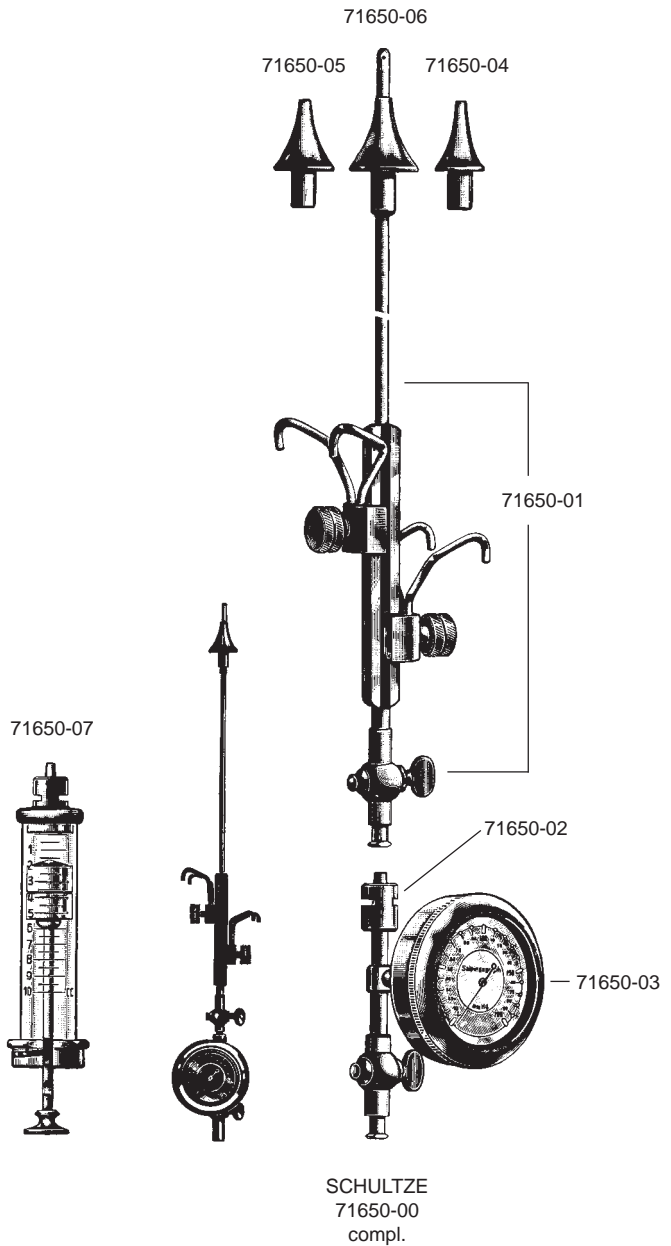

im Etui  
 in case  
 en estuche  
 in astuccio

Uterus-Küretten  
 Uterine Curettes  
 Curetas uterinas  
 Curette Uterine



SIMS

71710-05 - 71717-14  
 28 cm, 11"

	scharf sharp cort. tagl.	Fig.	mm	stumpf blunt roma smussa
fest	71710-05	00	5,0	71715-05
rig.	71710-06	0	6,0	71715-06
	71710-07	1	7,5	71715-07
	71710-08	2	8,5	71715-08
	71710-09	3	10,0	71715-09
	71710-11	4	11,5	71715-11
	71710-12	5	13,5	71715-12
	71710-14	6	14,5	71715-14

flexibel	71712-05	00	5,0	71717-05
flexible	71712-06	0	6,0	71717-06
fless.	71712-07	1	7,5	71717-07
	71712-08	2	8,5	71717-08
	71712-09	3	10,0	71717-09
	71712-11	4	11,5	71717-11
	71712-12	5	13,5	71717-12
	71712-14	6	14,5	71717-14



RECAMIER

71720-05 - 71727-20  
 31 cm, 12 1/4"

	scharf sharp cort. tagl.	Fig.	mm	stumpf blunt roma smussa
fest	71720-05	00	5	71725-05
rig.	71720-06	0	6	71725-06
	71720-07	1	7	71725-07
	71720-08	2	8	71725-08
	71720-09	3	9	71725-09
	71720-11	4	11	71725-11
	71720-12	5	12	71725-12
	71720-14	6	14	71725-14
	71720-15	7	15	71725-15
	71720-16	8	16	71725-16
	71720-19	9	19	71725-19
	71720-20	10	20	71725-20

flexibel	71722-05	00	5	71727-05
flexible	71722-06	0	6	71727-06
fless.	71722-07	1	7	71727-07
	71722-08	2	8	71727-08
	71722-09	3	9	71727-09
	71722-11	4	11	71727-11
	71722-12	5	12	71727-12
	71722-14	6	14	71727-14
	71722-15	7	15	71727-15
	71722-16	8	16	71727-16
	71722-19	9	19	71727-19
	71722-20	10	20	71727-20



BUMM

71730-30 - 71737-40  
 28 cm, 11"

	scharf sharp cort. tagl.	Fig.	mm	stumpf blunt roma smussa
fest	71730-30	14		71735-30
rig.	71730-35	15		71735-35
	71730-40	16		71735-40

flexibel	71732-30	14		71737-30
flexible	71732-35	15		71737-35
fless.	71732-40	16		71737-40



Uterus-Küretten  
 Uterine Curettes  
 Curetas uterinas  
 Curette uterine

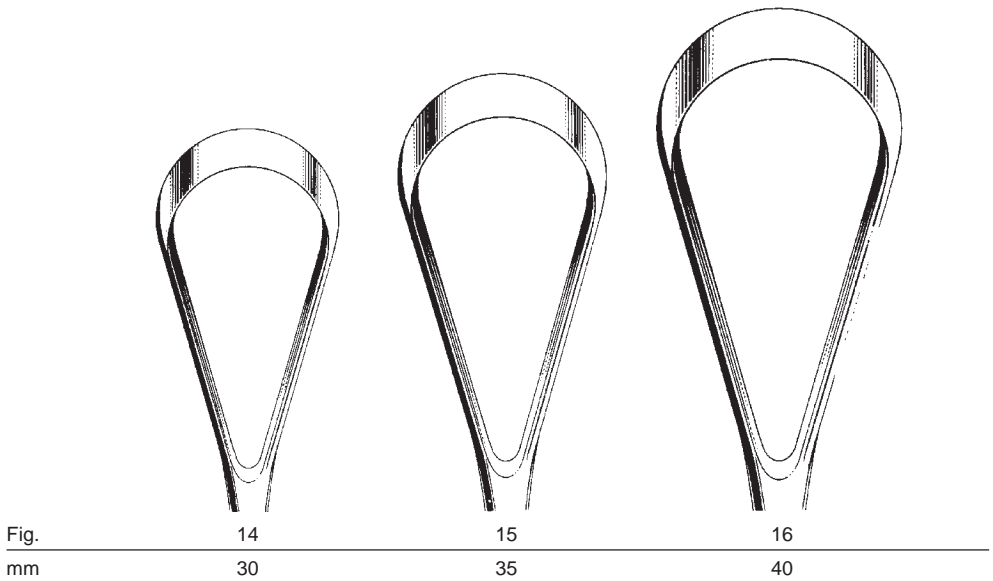
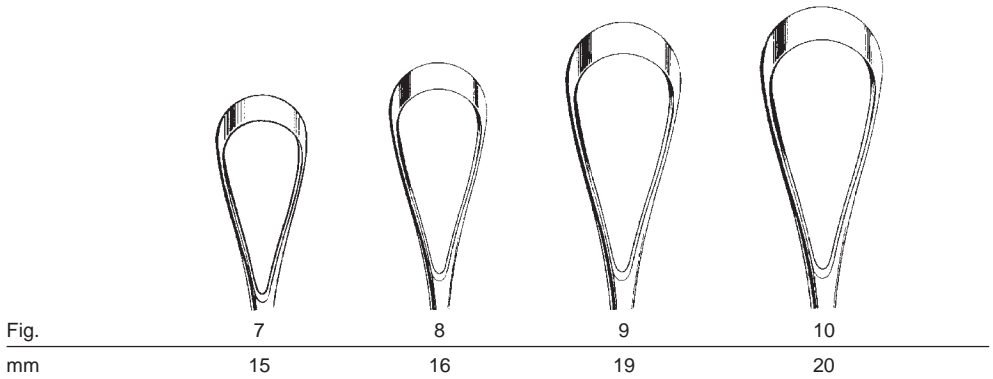
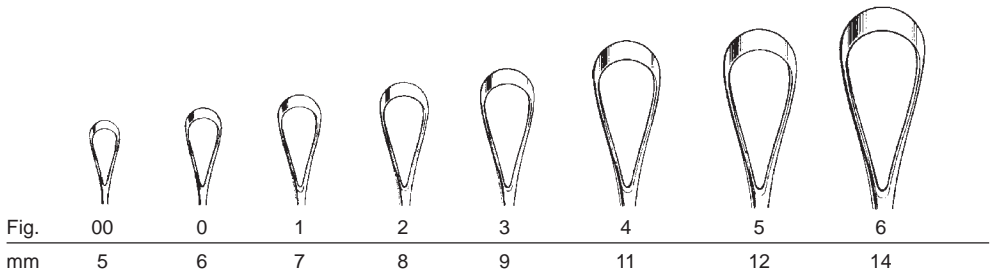

SIMS  
 RECAMIER  
 BUMM  
 71710-05 - 71735-28

Uterus-Küretten  
 Uterine Curettes  
 Curetas uterinas  
 Curette uterine



THOMAS  
 28 cm, 11"

stumpf  
 blunt  
 roma  
 smussa

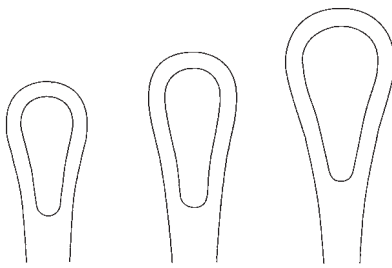

Fig.0  
 6 mm  
 71736-00

Fig.1  
 7 mm  
 71736-07

Fig.2  
 8 mm  
 71736-08

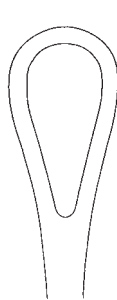

Fig.3  
 9 mm  
 71736-09



Fig. 4  
 10 mm  
 71736-10

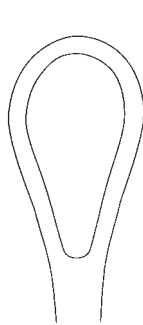

Fig. 5  
 11 mm  
 71736-11

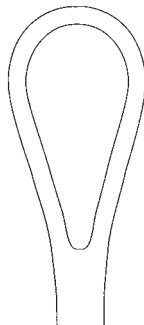
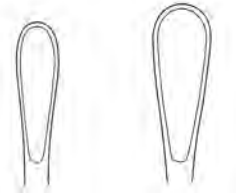

Fig. 6  
 12 mm  
 71736-12



GOURDET  
 28 cm, 11"



6 mm  
 71737-06

8 mm  
 71737-08



10 mm  
 71737-10



12 mm  
 71737-12



14 mm  
 71737-14

Biopsie- und Absaugküretten, Schlauch-Verbindungsstück  
 Specimen and Aspirating Curettes, Hose connecting piece  
 Curetas para biopsia y aspiración, Pieza conexión para tubos  
 Curette di aspirazione per biopsia, Raccordo di connessione per tubi

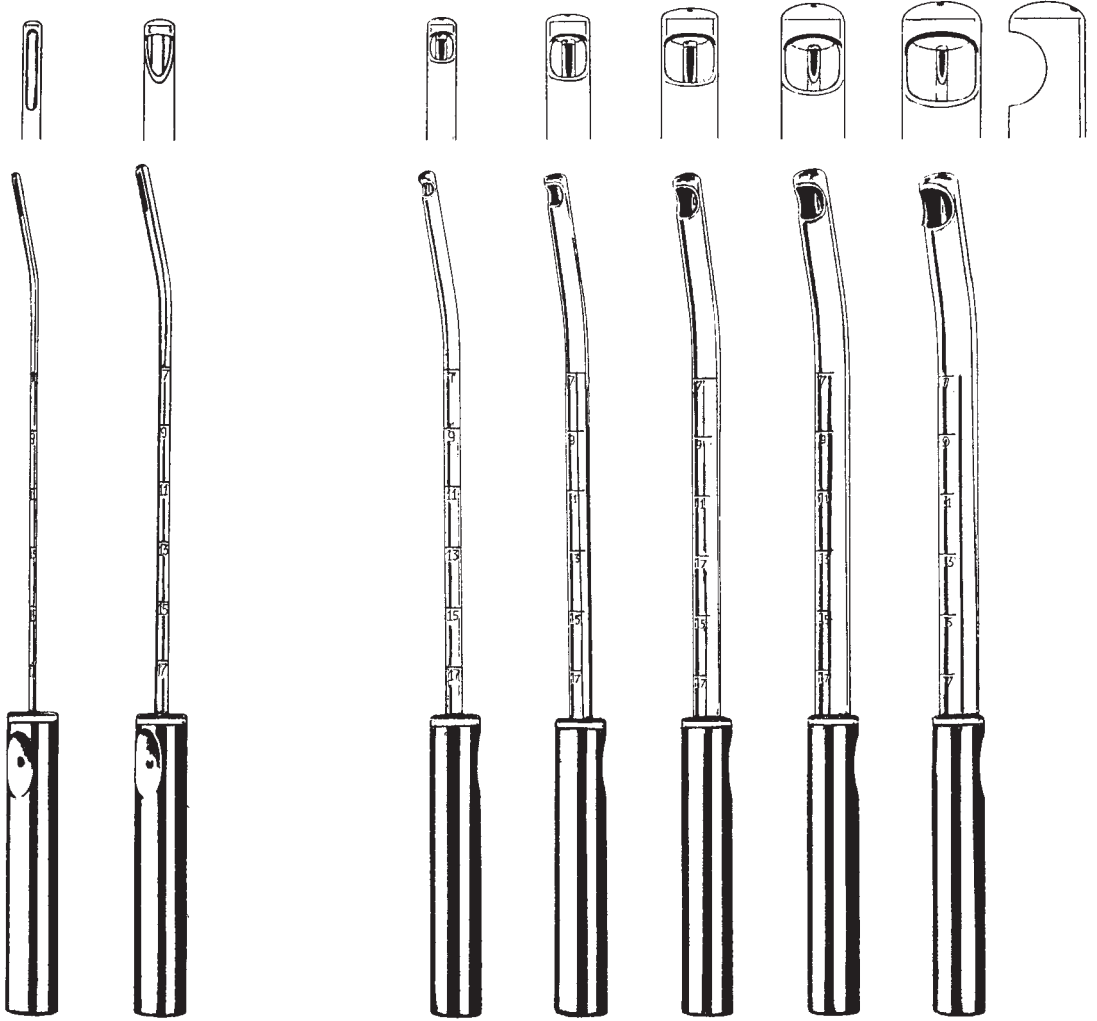

71803-03  
3 mm Ø

71803-04  
4,5 mm Ø

71803-06  
6 mm Ø

71803-08  
8 mm Ø

71803-10  
10 mm Ø

71803-12  
12 mm Ø

71803-14  
14 mm Ø



71803-15

Amnioskope  
Amnioscope  
Amnioscopio  
Amnioscopio



71810-12 12 x 24 mm Ø 20 cm (8") lang  
71810-16 16 x 24 mm Ø 20 cm (8") lang  
71810-20 20 x 24 mm Ø 20 cm (8") lang



71810-50  
Kaltlichtklammer  
Cold Light clamp  
Adaptador de iluminacion  
Adattore di illuminazione

Geburtszangen  
 Obstetrical Forceps  
 Forceps obstétricos  
 Forcipi

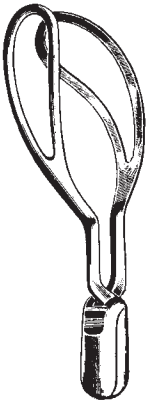

WRIGLEY  
 73101-23  
 23 cm, 9"

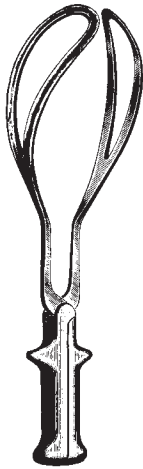

SIMPSON  
 73102-30  
 30 cm, 11 3/4"

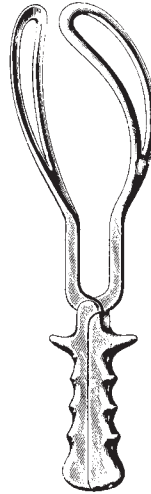

SIMPSON-BRAUN  
 73105-33 33 cm, 13"  
 73105-36 36 cm, 14"

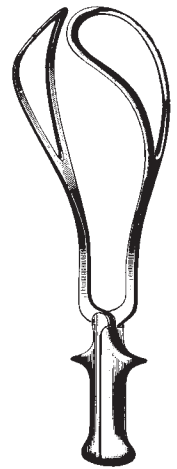

De LEE  
 73107-30  
 30 cm, 11 3/4"



De LEE  
 73108-36 36 cm, 14"  
 73108-39 39 cm, 15 1/2"

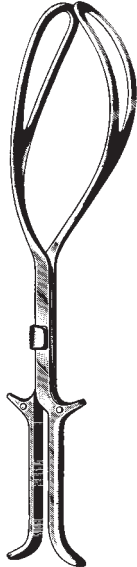

KIELLAND  
 73110-41  
 41 cm, 16"



ELLIOT  
 73115-32 32 cm, 12 3/4"  
 73115-38 38 cm, 15"

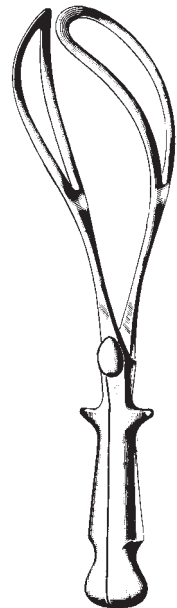

NAEGELE  
 73119-36 36 cm, 14"  
 73119-40 40 cm, 15 3/4"

Geburtszangen  
 Obstetrical Forceps  
 Forceps obstétricos  
 Forcipi

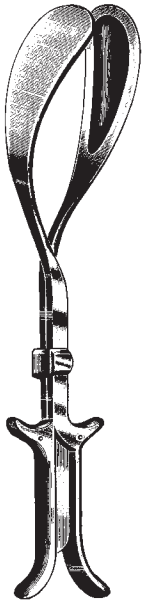

LUIKART  
 73125-40  
 40 cm, 15 3/4"

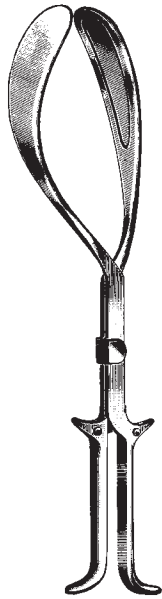

KIELLAND-LUIKART  
 73127-40  
 40 cm, 15 3/4"

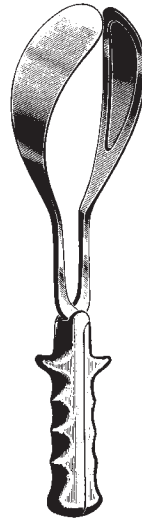

SIMPSON-LUIKART  
 73135-36  
 36 cm, 14"

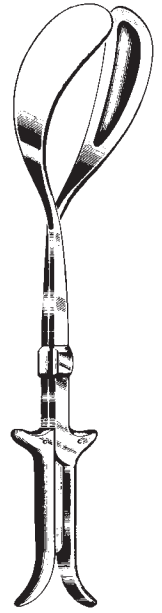

McLEAN-TUCKER-LUIKART  
 73139-40  
 40 cm, 15 3/4"



McLEAN-TUCKER  
 73141-39  
 39 cm, 15 1/2"



McLEAN-LUIKART  
 73143-39  
 39 cm, 15 1/2"

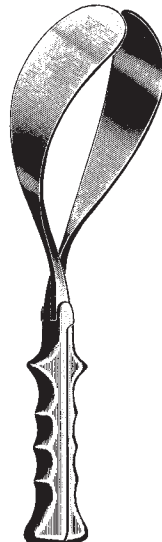

McLEAN  
 73145-36  
 36 cm, 14"

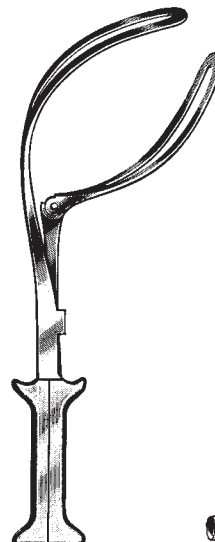

BARTON  
 73147-36  
 36 cm, 14"

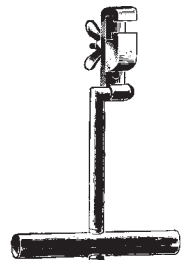

BARTON  
 73148-17  
 17 cm, 6 3/4"

Geburtszangen, Zughebel  
 Obstetrical Forceps, Traction handles  
 Forceps obstétricos, Dispositivos de tracción  
 Forcipi, Leve per trazione

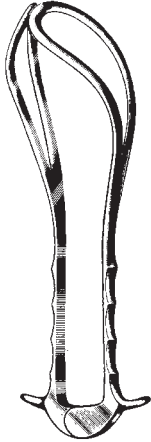

BOERMA  
 73151-29  
 29 cm, 11 1/2"

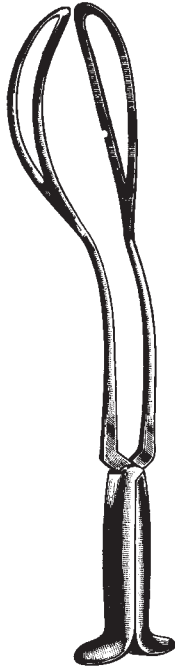

PIPER  
 73155-44  
 44 cm, 17 1/4"

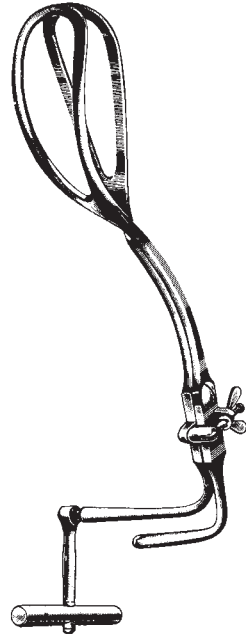

PIPER  
 73157-40  
 40 cm, 15 3/4"

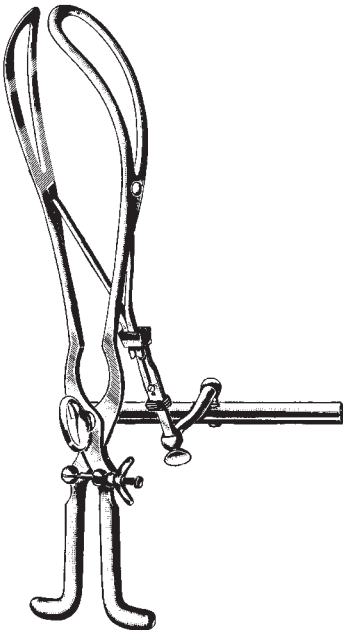

TARNIER  
 73162-40  
 40 cm, 15 3/4"

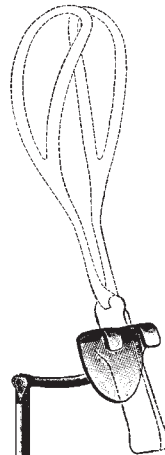

BILL  
 73170-00  
 21 cm, 8 1/4"

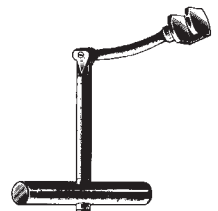

LUIKART-BILL  
 73171-21  
 21 cm, 8 1/4"

Haken, Kopfschwartzangen, Uterus-Klemmzange, Nabelschnurklemmen, Beckenzirkel  
 Scalp flap forceps, Uterine haemostatic forceps, Umbilical cord clamps, Pelvimeters  
 Pinzas para cuero cabelludo, Pinzas-clamps uterinas para hemóstasis, Clamp umbilical, Pelvímetros  
 Pinza per il cuoio capelluto, Pinza uterina, Pinza ombelicale, Pelvimetri



SMELLIE  
 73181-33  
 33 cm, 13"

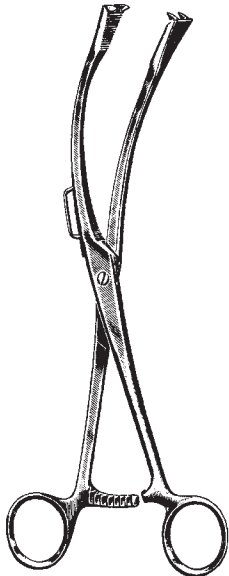

GAUSS  
 73183-27  
 27 cm, 10 1/2"

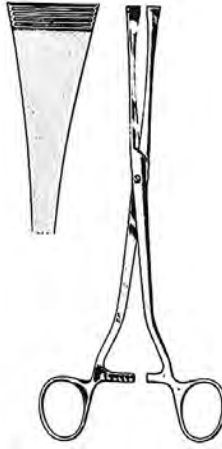

GREEN-ARMYTAGE  
 73184-21  
 21 cm, 8 1/4"

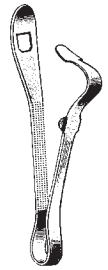

COLLIN  
 73187-09  
 9 cm, 3 1/2"

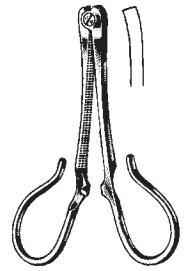

KANE  
 73189-09  
 8,5 cm, 3 1/4"

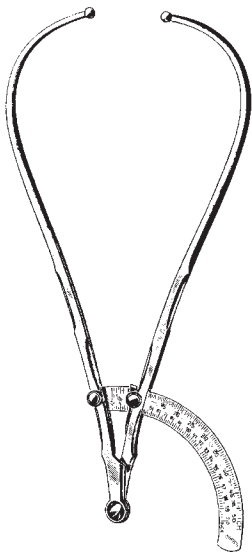

MARTIN  
 73191-34  
 34 cm, 13 1/2"

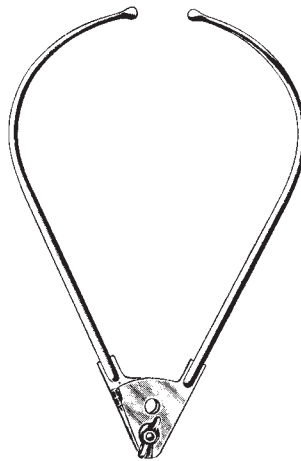

COLLIER  
 73193-30  
 30 cm, 11 3/4"

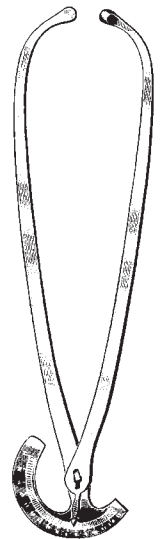

COLLIN  
 73195-35  
 35 cm, 14"



Abortuszangen, Abortuslöffel  
 Ovum Forceps, Abortion Scoops  
 Pinzas para aborto, Cucharillas para aborto  
 Ostetricia, Curette per aborto



SAENGER  
 73242-27 73243-27  
 27 cm, 10 1/2"

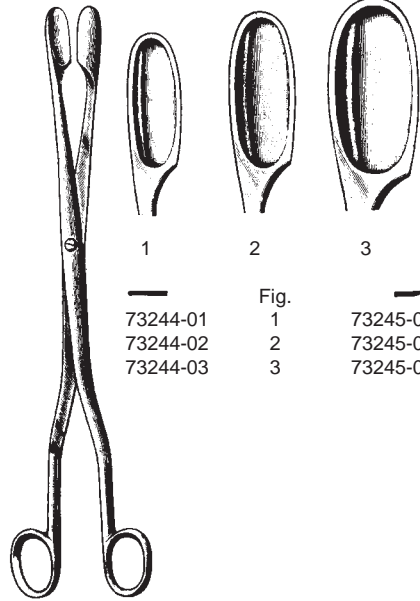

WINTER  
 73244-01 - 73245-03  
 28 cm, 11"

	1	2	3
Fig.	1	2	3
	73244-01	73245-01	73245-01
	73244-02	73245-02	73245-02
	73244-03	73245-03	73245-03

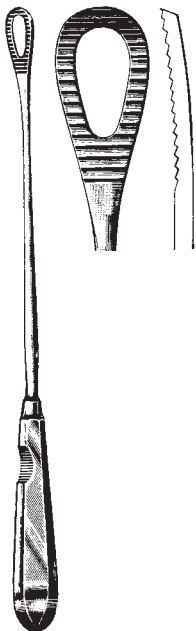

PESTALOZZA  
 73252-30  
 30 cm, 11 3/4"

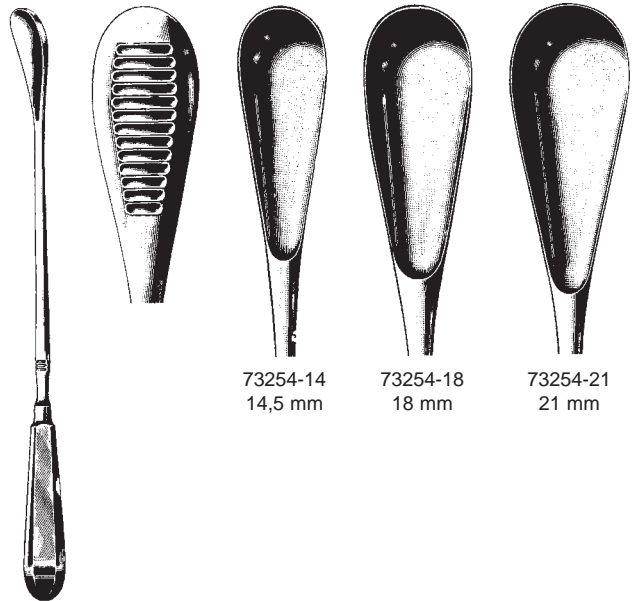

CUZZI  
 73254-14 - 73254-21  
 30 cm, 11 3/4"

73254-14	73254-18	73254-21
14,5 mm	18 mm	21 mm

Abortuslöffel, Geburtslöffel, Kranioklast, Basiotrip, Perforatorie, Dekapitationshaken  
 Abortion Scoops, Elevating Spoon, Cranioclast, Basiotribe, Perforators, Decapitating hook  
 Cucharillas para aborto, Separador obstetrico, Craneoclasto, Basiotribo, Perforacráneos, Gancho para decapitación  
 Curette per aborto, Cucchiaio Ostetrico, cranioclasto, Basiotribo, spezzacrani, Uncino per decapitazione



stumpf  
blunt  
roma  
smussa



WALLICH  
73256-42  
42 cm, 16 1/2"



SELLHEIM  
73259-28  
28 cm, 11"

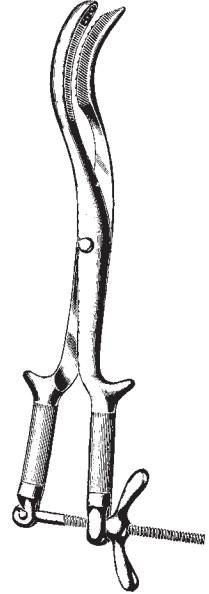

BRAUN  
73302-42  
42 cm, 16 1/2"



TARNIER  
73304-46  
46 cm, 18"

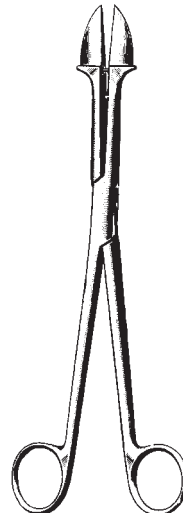
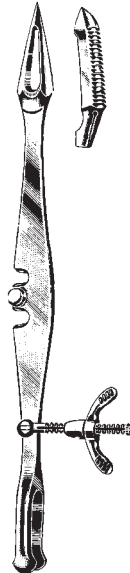

SMELLIE  
73306-25  
25 cm, 10"

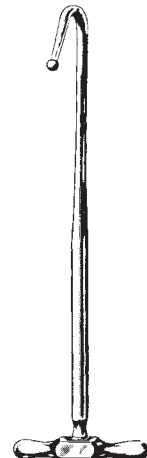

BRAUN  
73309-30  
30 cm, 11 3/4"

Hauthäkchen, Komedonenquetscher, Lupusküretten, Hautküretten, Haut-Trephinen  
 Skin hooks, Comedone extractors, Lupus curettes, Skin curettes, Cutaneous punches  
 Ganchos cutáneos, Sacca comedones, Curetas para lupus, Curetas cutáneas, Trépanos cutáneos  
 Uncinci cutanei, Schiaccia comedoni, Curette per lupus, Curette cutanee, Trefine cutanee



**KILNER**  
 75103-15  
 15 cm, 6"



**SCHAMBERG**  
 75111-10  
 10 cm, 4"



**UNNA**  
 75113-14  
 14 cm, 5 1/2"

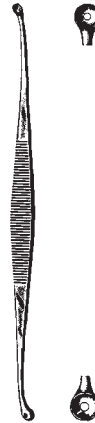

**UNNA**  
 75115-14  
 14 cm, 5 1/2"



**WALTON**  
 75118-14  
 14 cm, 5 1/2"



**SAALFELD**  
 75121-10  
 10 cm, 4"

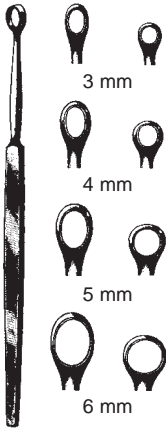

14 cm, 5 1/2"

FOX		FOX	
75128-01	1 mm	75129-01	1 mm
75128-02	2 mm	75129-02	2 mm
75128-03	3 mm	75129-03	3 mm
75128-04	4 mm	75129-04	4 mm
75128-05	5 mm	75129-05	5 mm
75128-06	6 mm	75129-06	6 mm

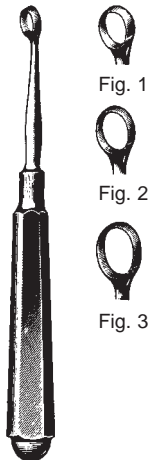

**PIFFARD**  
 14,5 cm, 5 3/4"  
 75130-01 Fig. 1  
 75130-02 Fig. 2  
 75130-03 Fig. 3

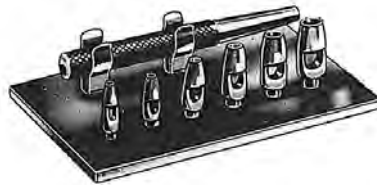

**75138-00**  
 Satz komplett mit 6 Aufsätzen  
 Set complete with 6 tips  
 Juego con 6 puntas  
 Serie completa con 6 trefini

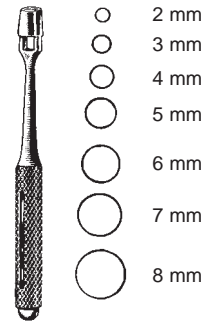

**KEYES**  
 10 cm, 4"  
 75140-02 2 mm  
 75140-03 3 mm  
 75140-04 4 mm  
 75140-05 5 mm  
 75140-06 6 mm  
 75140-07 7 mm  
 75140-08 8 mm

Nagelzangen, -Scheren  
Nail Nippers, Scissors  
Alicates corta-uñas  
Tronchesini forbici per unghie



75301-10

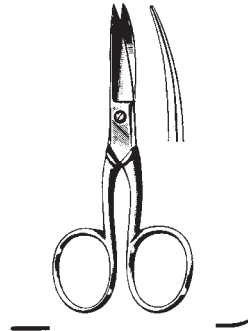

75304-10 10 cm, 4" 75305-10



75331-14  
14 cm, 5 1/2"  
stainless



TURNBULL  
75341-11 11,5 cm, 4 1/2"  
75341-13 13,5 cm, 5 1/4"  
stainless

Nagelhautzangen, Hautscheren, Nagelfeilen  
Cuticle Nippers, Cuticle Scissors, Nail Files  
Pinzas y Tjeras cuticulares, Limas para uñas  
Tronchesine per unghie e pelle, Limette per le unghie



75373-10  
10,5 cm, 4"

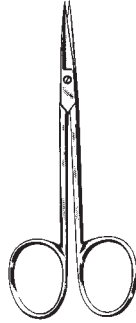

75378-10  
10 cm, 4"

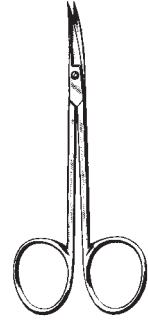

75379-10  
10 cm, 4"



75382-16



75386-10 10 cm, 4"  
75386-12 12 cm, 4 3/4"

Bürstenspender, Handwaschbürsten  
Brush Dispensor, Nail brushes  
Dispensador de cepillos, Cepillo para uñas  
Distributore di spazzole, Spazzole per unghie

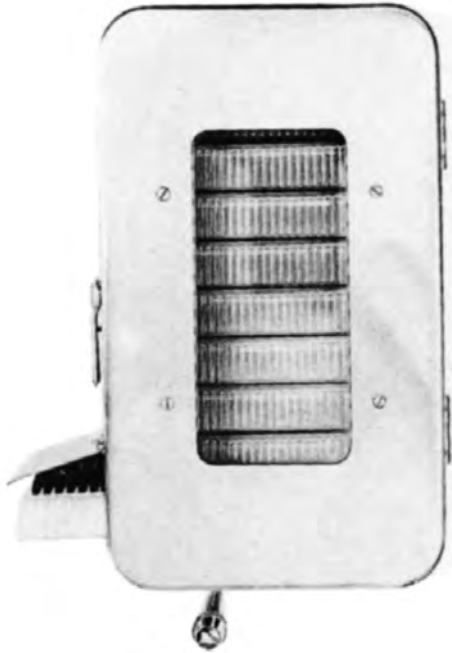

75396-01  
Bürstenspender für 10 Bürsten  
Brush dispenser for 10 brushes  
Distribuidor de cepillos para 10 cepillos  
Distributore per spazzolini da 10

75396-02  
Bürstenspender für 20 Bürsten  
Brush dispenser for 20 brushes  
Distribuidor de cepillos para 20 cepillos  
Distributore per spazzolini da 20

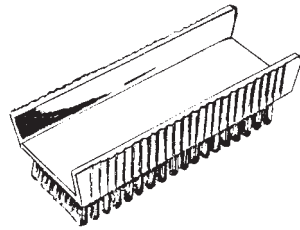

75397-00

Pack. à 10 St.  
Box of 10 pcs  
caja de 10 pzas.  
confezione da 10 pezzi



PROBE AND PACKER  
75450-00  
14,5 cm, 5 3/4"



SPATULA AND PACKER  
75440-00  
14,5 cm, 5 3/4"



mit Loch, with hole,  
con agujero, con foro

75430-12 = 1,5 mm + 2 mm  
75430-13 = 1,5 mm + 2,5 mm  
14,5 cm, 5 3/4"



14,5 cm, 5 3/4"  
ohne Loch, without hole,  
sin agujero, senza foro

75400-01 = 1 mm  
75400-02 = 1,5 mm  
75400-03 = 2 mm  
75400-04 = 2,5 mm

mit Loch, with hole,  
con agujero, con foro

75410-01 = 1 mm  
75410-02 = 1,5 mm  
75410-03 = 2 mm  
75410-04 = 2,5 mm

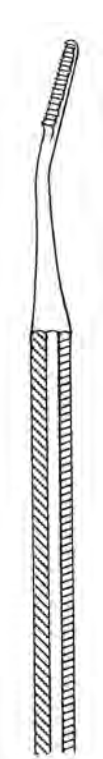

75420-15  
15 cm, 6"

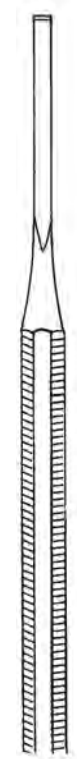

75430-01  
12,5 cm, 5"

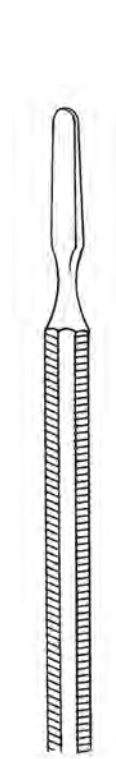

75440-11  
11,5 cm, 4 1/2"



Nagelzangen  
 Nail Nippers  
 Alicates corta-uñas  
 Tronchesini per unghie

stainless steel



75450-13  
 concave

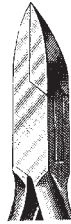

75460-13  
 gerade  
 straight  
 recto  
 retta



75450-13 - 75460-13  
 13 cm, 5 1/8"

stainless steel



75470-11  
 10 cm  
 4"



75475-11  
 11,5 cm  
 4 1/2"

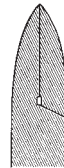

75480-13  
 12,5 cm  
 5"

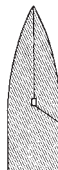

fine  
 75485-13  
 12,5 cm  
 5"

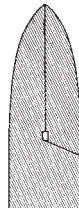

75490-15  
 15 cm  
 6"

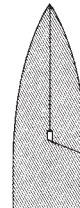

fine  
 75500-15  
 15 cm  
 6"

Nagelzangen  
 Nail Nippers  
 Alicates corta-uñas  
 Tronchesini per unghie

stainless steel

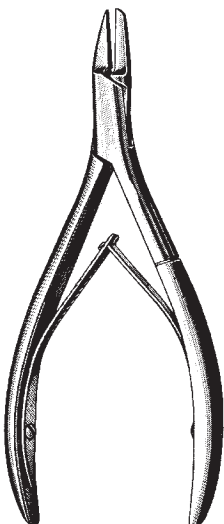

ANVIL  
 75550-13  
 13 cm, 5 1/8"

stainless steel

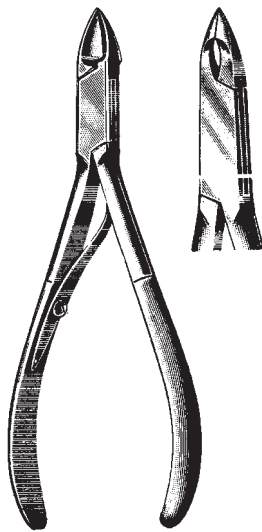

75600-10  
 10 cm, 4"

stainless steel



75618-15  
 15,2 cm, 6"

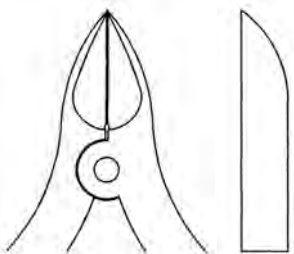

gerade  
 straight

stainless steel

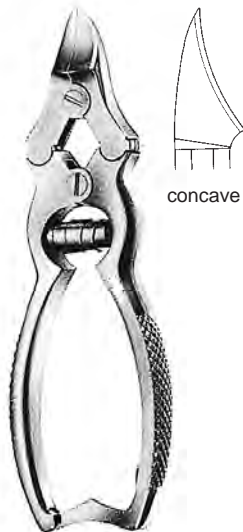

75620-15  
 15,5 cm, 6"

concave

Nagelzangen, Nagelscheren  
Nail Nippers, Nail scissors  
Alicates corta-uñas, Tijeras para uñas  
Tronchesini per unghie, Forbici per unghie



75630-12  
12 cm, 4 3/4"



75640-15  
15 cm, 6"

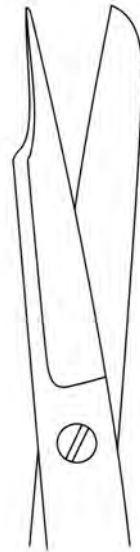

Nagelspaltscheren  
Nail splitting scissors  
Tijeras para hender uñas  
Forbici per staccare unghie

Nadel-Sterilisierkästen, Kappenzangen  
 Needle Sterilizing cases, Sterilizing Forceps  
 Estuches para esterilizar agujas, Combinacion tapa-pinza  
 Scatole per sterilizzare aghi, Pinza coperchio

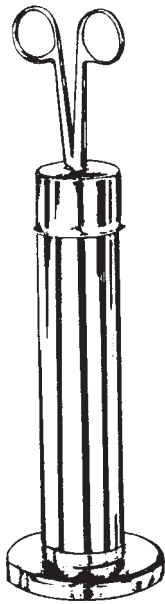

89111-25 25 cm, 10"  
 89111-32 32 cm, 12<sup>3</sup>/<sub>4</sub>"



89112-65  
 65 x 15 mm



89113-65



89114-00  
 150 x 95 x 13 mm



89115-50 50 x 25 x 4,5 mm  
 89115-65 65 x 42 x 8,0 mm  
 89115-75 75 x 25 x 4,5 mm



89116-50 50 x 25 x 4,5 mm  
 89116-65 65 x 42 x 8,0 mm  
 89116-75 75 x 25 x 4,5 mm

Sterilisierkästen  
Sterilizing Cases  
Cajas para esterilización  
Scatole per sterilizzazione



89117-20 200 x 100 x 25 mm  
89117-23 230 x 130 x 25 mm  
89117-27 275 x 230 x 25 mm

Sterilisier-Behälter mit Silikonmatte  
Micro instrument tray with silicone mat  
Caja para instrumental micro-quirurgico con alfombrilla de silicona  
Scatola per sterilizzazione con stuoia in silicone

89118-20  
89118-23  
89118-27

Silikonmatte  
Silicone mat  
Alfombrilla de silicona  
Stuoia in silicone

Instrumentenkästen  
Instrument Boxes  
Cajas para instrumentos  
Scatole per strumenti



Abmessungen in mm	ohne Knopfdeckel
Sizes in mm	lid without knob
tamaños en mm	tapa sin botón
misura in mm	coperchio senza bottone

l x b x h mm

165x 85x35

89122-16

200x100x50

89122-21

260x150x50

89122-26

310x200x50

89122-30

Sterilisierkästen  
 Sterilizing Cases  
 Cajas para esterilización  
 Scatole per sterilizzazione

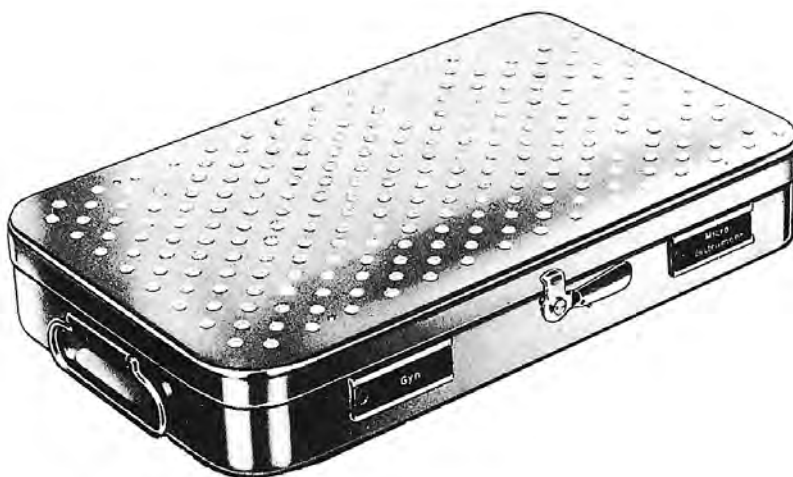

Abmessungen in mm (l x b x h)  
 Sizes in mm (l x b x h)  
 tamaños en mm (l x f x a)  
 misura in mm (l x l x a)

Behälter  
 Containers  
 Recipientes  
 Recipienti

Satz Spezialfilter (5 Paar)  
 Set of spezial filters (5 pairs)  
 Juego de filtros especiales (5 pares)  
 Set die 5 paia di filtri speciali

230 x 130 x 50  
 260 x 150 x 50  
 275 x 235 x 50  
 300 x 200 x 50  
 325 x 275 x 50  
 420 x 175 x 50

89124-23  
 89124-26  
 89124-27  
 89124-30  
 89124-32  
 89124-42

89126-23  
 89126-26  
 89126-27  
 89126-30  
 89126-32  
 89126-42

230 x 130 x 75  
 260 x 150 x 75  
 300 x 200 x 75  
 325 x 275 x 75  
 420 x 175 x 75

89125-23  
 89125-26  
 89125-30  
 89125-32  
 89125-42

89127-23  
 89127-26  
 89127-30  
 89127-32  
 89127-42

Schalen  
Trays  
Bandejas  
Bacinelle

18/10  
Stainless Steel  
Acero inoxidable  
Acciaio inossidabile

matt  
satin finish  
pulidas mate  
opaco



Abmessungen in mm sizes in mm Tamaños en mm misura in mm Ø x h	Inhalt capacity capacidad capacità l	
40x19	0,05	89127-04
61x30	0,07	89127-06
80x40	0,14	89127-08
116x50	0,35	89127-11
128x55	0,45	89127-12
147x65	0,70	89127-14
167x75	1,10	89127-16
187x85	1,60	89127-18



Abmessungen in mm sizes in mm Tamaños en mm misura in mm Ø x h	Inhalt capacity capacidad capacità l	
110x28	0,15	89129-11



	mm x mm	l
89133-16	165 x 60	0,75
89133-17	175 x 70	1,00
89133-22	220 x 80	2,00
89133-24	240 x 110	3,00
89133-25	255 x 115	4,00
89133-31	310 x 120	6,00
89133-34	345 x 125	8,50
89133-38	380 x 130	11,00



89139-17	170 x 100 x 35 mm	0,50 l
89139-25	250 x 140 x 40 mm	1,25 l
89139-27	275 x 150 x 45 mm	2,25 l



Meßbecher, Dose, Standgefäß, Mehrzweckschalen  
 Graduated Measures, Box, Jars, Universal Trays  
 Copas graduadas, Recipientes, Tarros, Bandejas para instrumentos  
 Bicchieri graduati, Recipienti, Recipienti cilindrici, Bacinelle per strumenti

18/10  
 Stainless Steel  
 Acero inoxidable  
 Acciajo inossidabile

matt  
 satin finish  
 pulidas mate  
 opaco



l	
0,25	89140-02
0,5	89140-05
1,0	89140-10
2,0	89140-20



89141-10  
 100 x 20 mm



	mmxmm
89142-01	30x 90
89142-02	50x100
89142-03	50x130
89142-04	50x175
89142-05	75x100
89142-06	75x130
89142-07	75x175



89147-21 - 89147-42

	l x b x h
89147-21	210x160x10 mm
89147-24	240x180x10 mm
89147-30	310x150x10 mm
89147-31	310x210x10 mm
89147-35	350x240x10 mm
89147-40	400x270x20 mm
89147-42	420x280x10 mm



89145-23 - 89145-40

	l x b x h
89145-23	230x155x30 mm
89145-30	300x175x30 mm
89145-31	300x175x40 mm
89145-35	350x240x36 mm



89146-20 20 cc  
 110 x 20 mm



89147-10 100 cc  
 89147-25 250 cc



89148-25 25 cc  
 89148-50 50 cc



89148-31  
 ø 310 mm



89148-32



89148-35  
 350 x 290 x 90 mm



89149-13 110 x 13 mm  
 89149-20 95 x 20 mm



89150-30  
 90 x 80 mm

Verbandstofftrommel, Sterilisiersiebschalen  
 Sterilizing Drums, Sterilization Trays  
 Tambores p. esterilización, Cestas de esterilización  
 Tamburi p. sterilizzazione, Cestelli per sterilizzazione



SCHIMMELBUSCH

	Ø
	mmxmm
89152-08	125x 80
89152-10	125x100
89152-12	125x125
89155-08	150x 80
89155-10	150x100
89155-13	150x130
89155-15	150x150
89155-19	150x190
89159-14	190x145
89159-16	190x165
89159-19	190x190
89159-24	190x240
89164-14	240x145
89164-16	240x165
89164-19	240x190
89164-24	240x240
89164-29	240x290
89164-34	240x340
89164-39	240x390
89169-14	290x145
89169-16	290x165
89169-19	290x190
89169-24	290x240
89169-29	290x290
89169-34	290x340
89169-39	290x390
89174-14	340x145
89174-16	340x165
89174-19	340x190
89174-24	340x240
89174-29	340x290
89174-34	340x340
89174-39	340x390
89179-14	390x145
89179-16	390x165
89179-19	390x190
89179-24	390x240
89179-29	390x290
89179-34	390x340
89179-39	390x390
89179-49	390x490
89179-59	390x590

18/10  
 Stainless Steel  
 Acero inoxidable  
 Acciaio inossidabile  
 Acciaio inossidabile

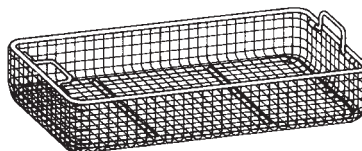

R390.03	255x245x 30 mm
R390.05	255x245x 50 mm
R390.07	255x245x 70 mm
R390.10	255x245x100 mm
R190.03	485x255x 30 mm
R190.05	485x255x 50 mm
R190.07	485x255x 70 mm
R190.10	485x255x100 mm
R191.03	540x255x 30 mm
R191.05	540x255x 50 mm
R191.07	540x255x 70 mm
R191.10	540x255x100 mm

Siebschalen, Endoskopiekorb  
Trays  
Bandejas  
Cestelli

Aus perforiertem Blech  
From Perforated Sheet Metal  
De chapa de acero perforada  
In acciaio perforato

18/10  
Stainless Steel  
Acero inoxidable  
Acciaio inossidabile



	cmxcmxcm
89250-10	24x24x 5
89250-20	24x24x 8
89250-30	24x24x10
89250-40	48x26x 5
89250-50	52x26x 8
89250-60	52x26x10

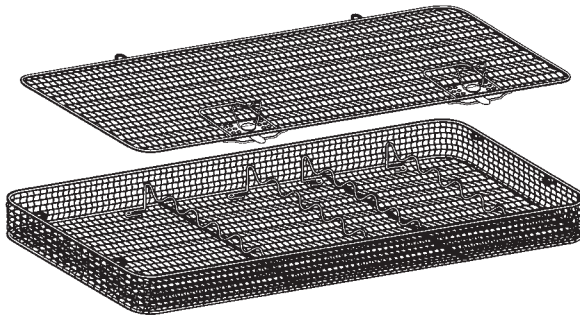

für Lichtleiterkabel  
for cold light cables  
para cables de luz fría  
per cavi a fibre/optiche  
89255-60 420x250x60 mm

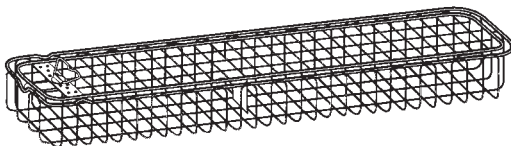

für 1 Endoskop, for 1 endoscope,  
para 1 endoscopio, per 1 endoscopio  
89256-29 290x80x52 mm  
89256-46 460x80x52 mm  
89256-67 670x80x52 mm

für 2 Endoskope, for 2 endoscopes,  
para 2 endoscopios, per 2 endoscopi rigidi  
89257-46 460x80x52 mm

Schlauchklemmen, Messgerät, Sterilisierklammern  
 Tubing Clamp, Decimal spring caliper, Safety pins  
 Pinzas para tubos, calibrador decimal, Cadres de estérilizacion  
 Morsetti serratubi, compasso, pinze per sterilizzazione

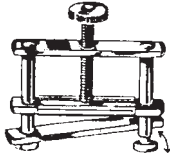

HOFFMANN  
 89260-13 13 mm  
 89260-17 17 mm  
 89260-20 20 mm  
 89260-25 25 mm  
 89260-30 30 mm  
 89260-40 40 mm

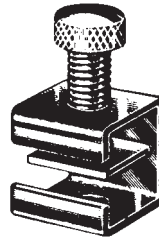

SIMPLEX  
 89265-12

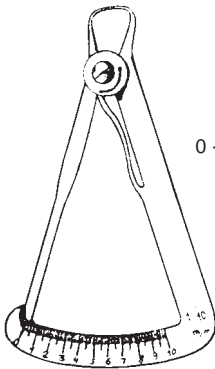

0 - 10 mm

IWANSON  
 89270-15



BUNT  
 29150-12  
 12 cm, 4 3/4"

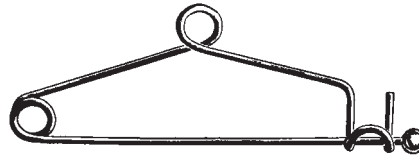

MAYO  
 29152-14  
 14 cm, 5 1/2"

Reinigungspistole  
Water Jet Pistol  
Pistola-lavatora  
Pistola lavatrice



89500-00  
komplett mit 9 Aufsätzen  
complete with 9 tips  
con 9 toberas  
completa con 9 raccordi

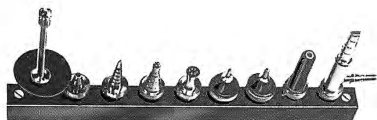

89500-12  
Pistole allein  
Pistol only  
Pistola sola  
Pistola sola

89500-06  
Reinigungsaufsatz für Kanülen mit Recordkonus  
Cleansing Tip for hypodermic needles with Record Cone  
Tobera para agujas de inyección con cono Record  
Raccordo di lavaggio per aghi ipodermici con cono Record



89500-07  
Reinigungsaufsatz für Kanülen mit Luerkonus  
Cleansing Tip for hypodermic needles with Luer Cone  
Tobera para agujas de inyección con cono Luer  
Raccordo di lavaggio per aghi ipodermici con cono Luer



89500-08  
Reinigungsaufsatz für Meß- und Vollpipetten  
Cleansing Tip for Meas. and Volumetric Pipettes  
Tobera para pipetas de medida y volumétricas  
Raccordo di lavaggio per pipette comuni e graduate



89500-09  
Reinigungsaufsatz für feine Pipetten  
Cleansing Tip for fine pipettes  
Tobera para pipetas finas  
Raccordo di lavaggio per pipette fine

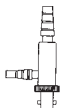

89500-01  
Reinigungsaufsatz für Flaschen  
Cleansing Tip for bottles  
Tobera para botellas  
Raccordo di lavaggio per bottiglie



89500-02  
Reinigungsaufsatz für Recordspritzen-Konen  
Cleansing Tip for Cones of Record Syringes  
Tobera para conos de jeringas Record  
Raccordo per coni di siringhe Record



89500-10  
Reinigungsaufsatz 31 cm (12 1/4") gerade  
Cleansing Tip 31 cm (12 1/4") straight  
Tobera 31 cm (12 1/4") recta  
Raccordo 31 cm (12 1/4") rette



89500-03  
Reinigungsaufsatz für Katheter  
Cleansing Tip for Catheters  
Tobera para catéteres  
Raccordo di lavaggio per cateteri



89500-04  
Reinigungsaufsatz für Drainageschläuche  
Cleansing Tip for Drainage Tubings  
Tobera para tubos de drenaje  
Raccordo di lavaggio per tubi di drenaggio

89500-11  
Reinigungsaufsatz 30 cm (11 3/4") aufgebogen  
Cleansing Tip 30 cm (11 3/4") curved  
Tobera 30 cm (11 3/4") curva  
Raccordo di lavaggio 30 cm (11 3/4") curvo



89500-05  
Reinigungsaufsatz für Hohlgefäße (Brause)  
Cleansing Tip for Receptacles (Shower)  
Tobera para recipientes (ducha)  
Raccordo di lavaggio per recipienti (doccia)

89501-03  
Überwurfmutter zum Anschluß an Gewindehähne  
Couplings for connection to water tap  
Tuercas-hembras para conexión al grifo de agua  
Dadi premistoppa per connessione ai rubinetti filettati

Hochfrequenz-Chirurgie  
 High Frequency Surgery  
 Electrocirugía  
 Electrochirurgia

Mindestbestellmenge 10  
 Minimum order quantity 10  
 Cantidad minima 10  
 Minimo di quantitativo 10



91010-01  
 Fig. 1



91010-02  
 Fig. 2 45°



91010-03  
 Fig. 3 120°



91010-11  
 Fig. 11  
 Ø 3 mm



91010-12  
 Fig. 12  
 Ø 5 mm



91010-13  
 Fig. 13  
 Ø 8 mm



91010-14  
 Fig. 14



91010-15  
 Fig. 15 45°  
 7,0x1,5 mm



91010-16  
 Fig. 16 45°  
 7 mm



91010-17  
 Fig. 17  
 6,0x1,3 mm



91010-18  
 Fig. 18 30°  
 7,0x1,7 mm



91010-21  
 Fig. 21  
 7,0x1,7 mm



91010-31  
 Fig. 31 45°  
 Ø 0,6 mm



91010-33  
 Fig. 33 45°  
 Ø 1,7 mm



91010-34  
 Fig. 34 45°  
 Ø 3,0 mm



91010-35  
 Fig. 35



91010-36  
 Fig. 36 90°

Schaft  
 shaft  
 vástago  
 asta  
 Ø 2,4 mm

Mindestbestellmenge 10  
 Minimum order quantity 10  
 Cantidad mínima 10  
 Minimo di quantitativo 10

Hochfrequenz-Chirurgie  
 High Frequency Surgery  
 Electrocirugía  
 Electrochirurgia



91011-51  
 Fig. 51 45°  
 Ø 3 mm



91011-52  
 Fig. 52 45°  
 7,0x1,7 mm



91011-53  
 Fig. 53 45°



91011-54  
 Fig. 54



91011-55  
 Fig. 55



91011-56  
 Fig. 56 45°  
 Ø 5 mm



91011-61  
 Fig. 61 45°



91011-62  
 Fig. 62 90°

Schaft  
 shaft  
 vástago  
 ast  
 Ø 2,4 mm

Serie STANDARD



91020-01



91020-02

Schaft  
 shaft  
 vástago  
 asta  
 Ø 4 mm



91020-03



91020-04



Ø mm  
 5 91022-05  
 10 91022-10  
 20 91022-20



Ø mm  
 10 91024-10  
 15 91024-15  
 20 91024-20



Ø mm  
 2 91030-02  
 4 91030-04  
 6 91030-06

Schaft  
 shaft  
 vástago  
 asta  
 Ø 4 mm



Bipolare Koagulation  
 Bipolar Coagulation  
 Coagulación bipolar  
 Coagulazione bipolare



91102-11  
 11 cm, 4 <sup>3</sup>/<sub>8</sub>"



91104-11  
 11 cm, 4 <sup>3</sup>/<sub>8</sub>"



91109-11  
 11 cm, 4 <sup>3</sup>/<sub>8</sub>"  
 45°



91113-11  
 11 cm, 4 <sup>3</sup>/<sub>8</sub>"  
 45°



91115-11  
 11 cm, 4 <sup>3</sup>/<sub>8</sub>"  
 45°



91122-16  
 16,5 cm, 6 <sup>1</sup>/<sub>2</sub>"



91123-16  
 16,5 cm, 6 <sup>1</sup>/<sub>2</sub>"



91124-16  
 16,5 cm, 6 <sup>1</sup>/<sub>2</sub>"  
 1 mm



91125-16  
 16,5 cm, 6 <sup>1</sup>/<sub>2</sub>"



91127-16  
 16,5 cm, 6 <sup>1</sup>/<sub>2</sub>"  
 1 mm

Bipolare Koagulation  
Bipolar Coagulation  
Coagulación bipolar  
Coagulazione bipolare



91142-16  
16,5 cm, 6 1/2"



91144-16  
16,5 cm, 6 1/2"



91146-16  
16,5 cm, 6 1/2"  
1 mm



91152-19  
19,5 cm, 7 3/4"



91154-19  
19,5 cm, 7 3/4"  
1 mm



91157-19  
19,5 cm, 7 3/4"  
1 mm



91159-19  
19,5 cm, 7 3/4"  
2 mm

Bipolare Koagulation  
 Bipolar Coagulation  
 Coagulación bipolar  
 Coagulazione bipolare



91162-19  
 19,5 cm, 7 3/4"



91164-19  
 19,5 cm, 7 3/4"  
 1 mm



91166-19  
 19,5 cm, 7 3/4"  
 2 mm



91167-19  
 19,5 cm, 7 3/4"  
 1 mm



91169-19  
 19,5 cm, 7 3/4"  
 1 mm



91172-03 - 91172-12  
 22,5 cm, 8.9"



91172-03  
 0,3 mm



91172-07  
 0,7 mm



91172-12  
 1,2 mm

Bipolare Koagulation  
 Bipolar Coagulation  
 Coagulación bipolar  
 Coagulazione bipolare

Verbindungskabel  
 Connection Cords  
 Cables de conexión  
 Cavi da connessione



		ERBE SELECT	AESCALAP	USA Mod.	MARTIN
3 m	118"	91190-30	91191-30	91192-30	91193-30
5 m	197"	91190-50		91192-50	91193-50

für Elektro-Chirurgie-Einheiten  
 for Electrosurgery Equipment  
 para Electrobisturías  
 per Elettrobisturi

Instrumentenöl  
Instrument oil  
Oleo para instrumentos  
Olio per strumenti

INSTRU CARE ist ein Instrumentenpflegeöl auf der Basis von hochreinen medizinischen Weißölen zum Erhalt der Funktionsfähigkeit und Werterhaltung von chirurgischen Instrumenten. Die Anwendung erfolgt nach der Reinigung bzw. vor dem Sterilisationsvorgang.

INSTRU CARE is an instrument oil for care and protection of surgical instruments and guarantees the function and protects the value of instruments. It will be used after cleansing and before sterilization process.

INSTRU CARE olio para instrumentos

INSTRU CARE è un olio estremamente puro per la lubrificazione e la pulizia dello strumentario chirurgico. Privo di silicone, appropriato per la sterilizzazione a vapore e ad aria calda. Fisiologicamente inerte con utilizzo prima della sterilizzazione.

Kunststoff-Flasche / plastic bottle / bottiglia / botella  
100ml 98000-01

Sprühdose / aerosol / spray / spray  
400ml 98000-02



03112-00.....	5	05151-01.....	27	05310-03.....	37	07224-00.....	43	09120-11.....	51
03112-01.....	5	05151-02.....	27	05310-04.....	37	07225-00.....	43	09120-13.....	51
03112-02.....	5	05160-01.....	28	05311-01.....	37	07290-09.....	45	09120-14.....	51
03113-00.....	6	05160-02.....	28	05311-02.....	37	07291-11.....	45	09120-15.....	51
03113-01.....	6	05160-03.....	28	05311-03.....	37	07294-13.....	45	09120-16.....	51
03113-02.....	6	05160-04.....	28	05311-04.....	37	07296-00.....	45	09120-18.....	51
03114-00.....	7	05170-24.....	28	05320-01.....	37	07402-01.....	46	09120-20.....	51
03114-01.....	7	05190-17.....	28	05320-02.....	37	07402-02.....	46	09121-11.....	51
03114-02.....	7	05190-20.....	28	05320-03.....	37	07402-03.....	46	09121-13.....	51
03120-00.....	8	05190-25.....	28	05320-04.....	37	07402-04.....	46	09121-14.....	51
03122-00.....	9	05203-00.....	31	05321-01.....	37	07402-05.....	46	09121-15.....	51
03126-00.....	10	05204-00.....	31	05321-02.....	37	07402-06.....	46	09121-16.....	51
03132-00.....	11	05210-00.....	29	05321-03.....	37	07402-07.....	46	09121-18.....	51
03132-01.....	11	05210-01.....	29	05321-04.....	37	07402-08.....	46	09121-20.....	51
03132-02.....	11	05210-02.....	29	07103-00.....	38	07402-09.....	46	09124-14.....	51
03133-00.....	12	05210-03.....	29	07103-01.....	38	07402-10.....	46	09125-14.....	51
03133-01.....	12	05210-04.....	29	07103-02.....	38	07403-01.....	47	09128-14.....	52
03133-02.....	12	05211-00.....	29	07104-00.....	39	07403-02.....	47	09130-14.....	52
03161-00.....	13	05211-01.....	29	07104-02.....	39	07410-05.....	47	09131-14.....	52
03161-01.....	14	05211-02.....	29	07105-02.....	39	07412-05.....	47	09140-14.....	52
03161-02.....	15	05211-03.....	29	07106-01.....	39/1	07420-08.....	48	09141-14.....	52
03161-03C.....	16	05211-04.....	29	07106-02.....	39/1	07421-09.....	48	09150-14.....	52
03161-03T.....	16	05220-00.....	29	07107-00.....	39/2	07422-19.....	48	09151-14.....	52
03167-03.....	20	05220-01.....	29	07107-01.....	39/2	07423-16.....	48	09160-14.....	52
03171-00.....	17	05220-02.....	29	07107-03.....	39/2	07423-20.....	48	09160-17.....	52
03171-01.....	17	05220-03.....	29	07107-04.....	39/2	07423-24.....	48	09160-23.....	52
03171-02.....	17	05220-04.....	29	07108-00.....	40	07424-11.....	48	09161-14.....	52
03180-90.....	21	05221-00.....	29	07109-03.....	40	07424-14.....	48	09161-17.....	52
03180-92.....	21	05221-01.....	29	07109-10.....	41	07424-17.....	48	09161-23.....	52
03180-93.....	21	05221-02.....	29	07109-13.....	41	07425-11.....	48	09164-14.....	52
03180-94.....	21	05221-03.....	29	07109-15.....	41	07490-00.....	49	09164-17.....	52
03195-00.....	22	05221-04.....	29	07110-00.....	42	07490-01.....	49	09164-23.....	52
03195-01.....	22	05223-00.....	31	07111-00.....	42	07490-02.....	49	09165-14.....	52
03195-04.....	22	05224-00.....	31	07112-00.....	42	07495-31.....	50	09165-17.....	52
03195-06.....	22	05230-00.....	30	07113-00.....	42	07496-00.....	49	09165-23.....	52
03195-07.....	22	05230-01.....	30	07115-00.....	42	07496-31.....	50	09170-15.....	52
03195-08.....	22	05230-02.....	30	07116-00.....	42	07498-00.....	50	09170-17.....	52
03195-09.....	22	05230-03.....	30	07118-00.....	42	07499-00.....	50	09170-21.....	52
03195-10.....	22	05230-04.....	30	07119-00.....	42	07499-01.....	50	09171-15.....	52
03246-00.....	23	05233-18.....	32	07120-00.....	42	09102-11.....	51	09171-17.....	52
03246-01.....	23	05234-28.....	32	07121-00.....	42	09102-13.....	51	09171-21.....	52
03246-02.....	23	05234-37.....	32	07122-00.....	42	09102-14.....	51	09174-15.....	52
03248-00.....	23	05238-01.....	32	07123-00.....	42	09102-15.....	51	09174-17.....	52
03260-15.....	23	05238-02.....	33	07124-00.....	42	09102-16.....	51	09174-21.....	52
03262-18.....	23	05238-03.....	33	07125-00.....	42	09102-18.....	51	09175-15.....	52
03288-17.....	24	05239-01.....	29, 30	07130-00.....	42	09102-20.....	51	09175-17.....	52
03288-20.....	24	05239-02.....	29, 30	07161-00.....	41	09103-11.....	51	09175-21.....	52
03292-22.....	24	05239-03.....	29, 30	07162-00.....	41	09103-13.....	51	09180-17.....	52
03294-24.....	24	05240-30.....	34	07165-00.....	41	09103-14.....	51	09181-17.....	52
03304-20.....	24	05241-11.....	34	07167-00.....	41	09103-15.....	51	09190-16.....	53
03306-17.....	24	05241-22.....	34	07200-17.....	44	09103-16.....	51	09191-16.....	53
03308-18.....	24	05300-01.....	36	07200-20.....	44	09103-18.....	51	09194-16.....	53
03310-01.....	25	05300-02.....	36	07201-13.....	44	09103-20.....	51	09195-16.....	53
03310-02.....	25	05300-03.....	36	07201-16.....	44	09104-14.....	51	09202-10.....	53
03312-01.....	25	05300-04.....	36	07201-19.....	44	09105-14.....	51	09203-10.....	53
03314-01.....	25	05300-05.....	36	07201-22.....	44	09110-11.....	51	09204-22.....	53
03320-19.....	25	05300-06.....	36	07202-12.....	44	09110-13.....	51	09206-10.....	53
03340-10.....	25	05301-01.....	35	07203-16.....	44	09110-14.....	51	09207-10.....	53
03340-15.....	25	05301-02.....	35	07203-19.....	44	09110-15.....	51	09280-12.....	53/1
03340-20.....	25	05301-03.....	35	07203-22.....	44	09110-16.....	51	09280-15.....	53/1
03340-30.....	25	05301-04.....	35	07204-11.....	44	09110-18.....	51	09280-18.....	53/1
03340-50.....	25	05301-05.....	35	07205-09.....	44	09110-20.....	51	09280-20.....	53/1
03350-15.....	25	05301-06.....	35	07210-00.....	43	09111-11.....	51	09280-23.....	53/1
03360-21.....	26	05301-07.....	35	07211-00.....	43	09111-13.....	51	09280-25.....	53/1
03361-10.....	26	05302-01.....	36	07212-00.....	43	09111-14.....	51	09280-28.....	53/1
05130-05.....	27	05302-02.....	36	07213-00.....	43	09111-15.....	51	09280-30.....	53/1
05130-10.....	27	05302-03.....	36	07215-00.....	43	09111-16.....	51	09281-12.....	53/1
05140-05.....	27	05303-01.....	36	07218-00.....	43	09111-18.....	51	09281-15.....	53/1
05140-08.....	27	05304-01.....	36	07219-00.....	43	09111-20.....	51	09281-18.....	53/1
05150-21.....	27	05310-01.....	37	07220-00.....	43	09114-14.....	51	09281-20.....	53/1
05150-27.....	27	05310-02.....	37	07222-00.....	43	09115-14.....	51	09281-23.....	53/1

09281-25.....	53/1	09346-11.....	54	09497-15.....	61	09831-12.....	67	10012-19.....	73
09281-28.....	53/1	09347-09.....	58	09501-22.....	63	09835-12.....	67	10013-19.....	73
09281-30.....	53/1	09348-01.....	55	09501-23.....	63	09850-10.....	68	10014-19.....	73
09282-15.....	53/1	09348-02.....	55	09505-22.....	63	09851-10.....	68	10015-19.....	73
09282-18.....	53/1	09348-03.....	55	09505-23.....	63	09852-10.....	68	10016-17.....	73
09282-20.....	53/1	09348-04.....	55	09510-20.....	62	09853-10.....	68	10017-17.....	73
09282-23.....	53/1	09348-05.....	55	09510-23.....	62	09854-11.....	69	10018-20.....	73
09282-25.....	53/1	09348-06.....	55	09511-20.....	62	09859-16.....	69	10019-20.....	73
09282-28.....	53/1	09349-09.....	58	09511-23.....	62	09860-16.....	69	10020-17.....	73
09283-15.....	53/1	09349-12.....	55	09512-20.....	62	09861-16.....	69	10021-17.....	73
09283-18.....	53/1	09350-09.....	57	09512-23.....	62	09898-20.....	69/1	10022-20.....	73
09283-20.....	53/1	09350-10.....	56	09513-20.....	62	09901-09.....	69/1	10023-20.....	73
09283-23.....	53/1	09351-09.....	57	09513-23.....	62	09901-11.....	69/1	10024-17.....	73
09283-25.....	53/1	09352-09.....	57	09514-20.....	62	09901-14.....	69/1	10025-17.....	73
09283-28.....	53/1	09353-09.....	57	09514-23.....	62	09901-18.....	69/1	10026-20.....	73
09284-12.....	53/1	09354-10.....	57	09515-20.....	62	09901-20.....	69/1	10027-20.....	73
09284-15.....	53/1	09355-10.....	57	09515-23.....	62	09905-14.....	69	10028-14.....	73
09284-18.....	53/1	09356-10.....	57	09516-23.....	62	09905-18.....	69	10029-14.....	73
09284-20.....	53/1	09357-10.....	57	09517-23.....	62	09906-18.....	69/1	10030-18.....	73
09284-23.....	53/1	09358-11.....	56	09523-24.....	62	09906-20.....	69/1	10031-18.....	73
09284-25.....	53/1	09360-11.....	58	09525-22.....	63	09911-23.....	69/1	10032-23.....	73
09284-28.....	53/1	09361-11.....	58	09530-17.....	63	09913-20.....	69/2	10033-23.....	73
09285-12.....	53/1	09362-11.....	58	09531-17.....	63	09913-22.....	69/2	10034-14.....	73
09285-15.....	53/1	09363-11.....	58	09536-27.....	63	09915-23.....	69/2	10035-14.....	73
09285-18.....	53/1	09370-11.....	58	09537-27.....	63	09921-16.....	69/2	10036-18.....	73
09285-20.....	53/1	09371-11.....	58	09540-16.....	61	09921-19.....	69/2	10037-18.....	73
09285-23.....	53/1	09374-11.....	58	09541-16.....	61	09930-14.....	70	10038-23.....	73
09285-25.....	53/1	09375-11.....	58	09542-16.....	61	09931-14.....	70	10039-23.....	73
09285-28.....	53/1	09381-11.....	58	09543-16.....	61	09933-23.....	70	10040-18.....	74
09285-30.....	53/1	09401-18.....	58	09548-18.....	64	09935-23.....	70	10041-18.....	74
09286-15.....	53/1	09403-15.....	58	09550-10.....	64	09937-23.....	70	10042-18.....	74
09286-18.....	53/1	09405-16.....	59	09551-16.....	64	09939-23.....	70	10044-14.....	74
09286-20.....	53/1	09406-16.....	59	09553-16.....	64	09941-20.....	70	10045-14.....	74
09286-23.....	53/1	09425-17.....	59	09560-14.....	64	09950-15.....	70	10046-14.....	74
09286-25.....	53/1	09427-17.....	59	09560-22.....	64	09950-18.....	70	10047-14.....	74
09286-28.....	53/1	09435-18.....	59	09580-11.....	65	09960-14.....	71	10048-14.....	74
09286-28.....	53/1	09437-19.....	59	09581-11.....	65	09961-14.....	71	10049-14.....	74
09287-15.....	53/1	09439-17.....	59	09582-15.....	65	09962-14.....	71	10102-11.....	75
09287-18.....	53/1	09468-15.....	59	09583-15.....	65	09962-17.....	71	10104-11.....	75
09287-20.....	53/1	09470-11.....	59	09601-22.....	65	09962-23.....	71	10110-12.....	75
09287-23.....	53/1	09473-21.....	59	09610-18.....	65	09963-14.....	71	10111-12.....	75
09287-25.....	53/1	09475-00.....	60	09611-18.....	65	09963-17.....	71	10113-11.....	75
09287-28.....	53/1	09475-25.....	60	09613-20.....	65/1	09963-23.....	71	10115-11.....	75
09289-28.....	53/2	09475-45.....	60	09614-19.....	65/1	09964-15.....	71	10117-11.....	75
09290-25.....	53/2	09475-60.....	60	09617-13.....	65/1	09964-17.....	71	10119-10.....	75
09291-18.....	54	09475-90.....	60	09619-17.....	65/1	09965-15.....	71	10120-16.....	76
09291-20.....	54	09476-00.....	60	09641-30.....	65/2	09965-17.....	71	10120-18.....	76
09291-23.....	54	09476-25.....	60	09643-19.....	65/2	09966-11.....	71	10120-22.....	76
09295-18.....	54	09476-45.....	60	09643-25.....	65/2	09967-11.....	71	10121-16.....	76
09295-20.....	54	09476-60.....	60	09651-24.....	65/2	09970-14.....	71	10121-18.....	76
09295-23.....	54	09476-90.....	60	09661-23.....	65/2	09970-18.....	71	10121-22.....	76
09302-14.....	54	09477-01.....	60	09770-18.....	66	09970-20.....	71	10122-16.....	76
09303-14.....	54	09478-25.....	60	09772-21.....	66	09970-23.....	71	10122-18.....	76
09304-14.....	54	09478-45.....	60	09774-21.....	66	09971-14.....	71	10122-22.....	76
09305-14.....	54	09478-60.....	60	09775-13.....	66	09971-18.....	71	10123-16.....	76
09310-12.....	54	09479-25.....	60	09777-13.....	66	09971-20.....	71	10123-18.....	76
09310-15.....	54	09479-45.....	60	09802-09.....	66	09971-23.....	71	10123-22.....	76
09312-12.....	54	09479-60.....	60	09802-11.....	66	09980-11.....	72	10124-16.....	76
09314-12.....	54	09480-25.....	61	09803-09.....	66	09981-11.....	72	10124-18.....	76
09320-15.....	54	09480-40.....	61	09803-13.....	66	09982-12.....	72	10124-22.....	76
09321-15.....	54	09480-60.....	61	09804-14.....	66	09983-12.....	72	10125-16.....	76
09321-18.....	54	09481-25.....	61	09809-15.....	66	09984-11.....	72	10125-18.....	76
09325-15.....	54	09481-40.....	61	09820-13.....	67	09985-11.....	72	10125-22.....	76
09340-09.....	54	09481-60.....	61	09821-13.....	67	09986-11.....	72	10126-00.....	77
09340-10.....	54	09490-16.....	61	09823-12.....	67	09990-14.....	72	10126-25.....	77
09340-11.....	54	09490-23.....	61	09824-12.....	67	09990-18.....	72	10126-45.....	77
09341-09.....	54	09491-16.....	61	09825-12.....	67	09993-15.....	72	10126-60.....	77
09341-10.....	54	09491-23.....	61	09826-12.....	67	09993-18.....	72	10126-90.....	77
09341-11.....	54	09492-16.....	61	09827-12.....	67	09995-12.....	72	10127-00.....	77
09344-11.....	54	09492-23.....	61	09828-12.....	67	10010-19.....	73	10127-25.....	77
09345-11.....	54	09496-15.....	61	09829-12.....	67	10011-19.....	73	10127-45.....	77

10127-60.....77	11120-20.....81/1	11231-20.....84	11403-04.....90	12340-20.....99
10127-90.....77	11120-25.....81/1	11232-15.....83	11404-04.....90	12340-24.....99
10128-09.....78	11120-30.....81/1	11233-20.....84	11405-05.....90	13001-08.....101
10128-15.....78	11122-12.....81/1	11234-20.....84	11407-07.....90	13001-10.....101
10129-15.....78	11122-13.....81/1	11235-20.....84	11802-09.....91	13001-12.....101
10130-15.....78	11122-14.....81/1	11236-15.....84	11802-10.....91	13002-08.....101
10131-14.....78	11122-15.....81/1	11236-20.....84	11802-11.....91	13002-10.....101
10131-16.....78	11122-18.....81/1	11237-20.....84	11810-07.....91	13002-12.....101
10132-18.....78	11122-21.....81/1	11240-14.....84	11810-09.....91	13005-10.....101
10133-10.....79	11122-25.....81/1	11242-14.....84	11810-11.....91	13005-14.....101
10135-10.....79	11124-15.....81/1	11246-18.....85	11812-10.....91	13005-20.....101
10137-01.....78	11126-18.....81	11248-18.....85	11813-10.....91	13006-10.....101
10137-02.....78	11126-21.....81	11250-14.....85	11815-12.....91	13006-14.....101
10140-08.....79	11126-25.....81	11252-20.....85	11816-10.....91	13006-20.....101
10141-08.....79	11130-11.....81/1	11256-15.....85	11817-10.....91	13010-30.....102
10142-08.....79	11130-13.....81/1	11256-20.....85	11821-11.....92	13010-35.....102
10143-08.....79	11130-14.....81/1	11256-25.....85	11822-13.....92	13010-40.....102
10151-11.....79	11130-16.....81/1	11257-15.....85	11823-13.....92	13010-50.....102
10153-11.....79	11130-18.....81/1	11258-15.....85	11824-14.....92	13011-30.....102
10155-11.....79	11130-20.....81/1	11259-15.....85	11825-14.....92	13011-35.....102
10202-18.....80	11132-16.....81/1	11260-12.....86	11828-15.....92	13011-40.....102
10203-18.....80	11132-18.....81/1	11260-15.....86	11829-15.....92	13011-50.....102
10313-14.....80	11132-20.....81/1	11261-15.....86	11900-01.....93	13012-30.....102
10313-16.....80	11132-25.....81/1	11270-12.....86	11901-05.....93	13012-35.....102
10320-09.....80	11132-30.....81/1	11270-15.....86	11910-01.....93	13012-40.....102
10330-19.....80	11140-11.....81/1	11271-15.....86	12102-12.....94	13012-50.....102
10331-19.....80	11140-13.....81/1	11271-18.....86	12103-12.....94	13013-30.....102
10333-19.....80	11140-14.....81/1	11272-15.....86	12104-15.....94	13013-35.....102
11102-10.....81	11140-16.....81/1	11273-15.....86	12105-15.....94	13013-40.....102
11102-11.....81	11140-18.....81/1	11274-06.....86	12108-18.....94	13013-50.....102
11102-13.....81	11140-20.....81/1	11274-08.....86	12109-18.....94	13014-30.....102
11102-14.....81	11140-25.....81/1	11274-10.....86	12110-15.....95	13014-35.....102
11102-16.....81	11150-13.....81/1	11302-17.....86	12110-20.....95	13014-40.....102
11102-18.....81	11150-14.....81/1	11302-23.....86	12110-24.....95	13014-50.....102
11102-20.....81	11150-16.....81/1	11303-17.....86	12110-30.....95	13015-30.....102
11102-25.....81	11160-13.....81/1	11304-17.....86	12200-16.....96	13015-35.....102
11102-30.....81	11160-14.....81/1	11305-17.....87	12201-16.....96	13015-40.....102
11103-14.....81	11160-16.....81/1	11310-17.....87	12291-22.....97	13015-50.....102
11104-12.....81	11170-12.....81/2	11311-17.....87	12293-22.....97	13090-40.....100
11104-13.....81	11170-15.....81/2	11312-17.....87	12295-22.....97	13090-45.....100
11104-14.....81	11174-12.....81/2	11312-18.....87	12297-22.....97	13090-50.....100
11104-15.....81	11174-15.....81/2	11313-17.....87	12302-16.....98	13091-40.....100
11104-18.....81	11176-12.....81/2	11314-01.....87	12302-20.....98	13091-45.....100
11104-21.....81	11176-15.....81/2	11314-02.....87	12302-24.....98	13091-50.....100
11104-25.....81	11177-12.....81/2	11315-01.....87	12304-16.....98	13092-07.....103
11106-13.....81	11178-12.....81/2	11315-02.....87	12304-20.....98	13092-08.....103
11106-15.....81	11179-12.....81/2	11316-14.....88	12304-24.....98	13092-10.....103
11110-11.....81	11180-12.....82	11316-16.....88	12304-30.....98	13092-12.....103
11110-13.....81	11180-15.....82	11316-20.....88	12306-16.....98	13093-07.....103
11110-14.....81	11181-12.....82	11317-00.....88	12306-20.....98	13093-08.....103
11110-16.....81	11181-15.....82	11317-12.....88	12306-24.....98	13093-10.....103
11110-18.....81	11186-12.....82	11317-23.....88	12306-30.....98	13093-12.....103
11110-20.....81	11186-15.....82	11318-18.....88	12308-16.....98	13096-06.....103
11110-25.....81	11187-12.....82	11318-20.....88	12308-20.....98	13096-07.....103
11110-30.....81	11187-18.....83	11318-25.....88	12308-24.....98	13096-09.....103
11112-18.....81	11187-20.....83	11319-12.....88	12308-30.....98	13096-11.....103
11112-21.....81	11187-25.....83	11319-14.....88	12309-16.....98	13097-06.....103
11112-25.....81	11187-30.....83	11320-18.....88	12309-20.....98	13097-07.....103
11114-14.....81	11188-12.....82	11320-23.....88	12309-24.....98	13097-09.....103
11114-16.....81	11188-15.....82	11322-15.....89	12309-30.....98	13097-11.....103
11114-20.....81	11189-12.....82	11322-18.....89	12310-16.....98	13098-06.....100
11114-25.....81	11189-15.....83	11322-23.....89	12310-20.....98	13099-07.....100
11116-18.....81	11189-20.....83	11324-23.....89	12310-24.....98	13102-04.....104
11116-21.....81	11189-25.....83	11325-15.....89	12310-30.....98	13102-05.....104
11116-25.....81	11190-10.....83	11325-23.....89	12320-15.....99	13103-04.....104
11120-10.....81/1	11220-17.....83	11325-25.....89	12320-20.....99	13103-05.....104
11120-11.....81/1	11221-17.....83	11326-23.....89	12320-24.....99	13110-50.....104
11120-13.....81/1	11222-17.....83	11328-15.....89	12330-16.....99	13110-55.....104
11120-14.....81/1	11223-17.....83	11328-20.....89	12330-20.....99	13110-65.....104
11120-16.....81/1	11224-17.....83	11401-01.....90	12330-24.....99	13110-70.....104
11120-18.....81/1	11225-17.....83	11403-03.....90	12340-16.....99	13110-75.....104



13110-90.....104	13311-13.....108	13384-20.....112	13451-24.....118	13597-10.....127
13111-50.....104	13311-14.....108	13384-26.....112	13453-18.....118	13597-20.....127
13111-55.....104	13311-16.....108	13385-20.....112	13453-24.....118	13597-30.....127
13111-65.....104	13311-18.....108	13385-26.....112	13455-01.....118	13597-40.....127
13111-70.....104	13311-20.....108	13386-20.....112	13455-02.....118	13598-24.....126
13111-75.....104	13311-22.....108	13386-26.....112	13456-01.....119	13599-24.....126
13111-90.....104	13311-24.....108	13387-20.....112	13456-02.....119	13600-20.....127
13115-00.....104	13311-26.....108	13387-26.....112	13456-03.....119	13601-20.....127
13210-10.....104	13311-30.....108	13390-20.....112	13457-28.....119	13605-26.....128
13211-10.....104	13312-14.....108	13391-20.....112	13459-18.....119	13702-14.....129
13212-10.....104	13312-16.....108	13393-20.....112	13459-28.....119	13704-16.....129
13213-10.....104	13313-14.....108	13394-20.....112	13471-14.....119/1	13704-18.....129
13214-10.....104	13313-16.....108	13395-20.....112	13471-16.....119/1	13710-15.....129
13215-10.....104	13320-13.....108	13410-18.....112	13471-18.....119/1	13710-18.....129
13220-12.....105	13320-14.....108	13411-18.....112	13471-23.....119/1	13710-20.....129
13220-14.....105	13320-16.....108	13412-18.....113	13473-23.....119/1	13712-15.....129
13220-18.....105	13320-18.....108	13413-18.....113	13474-19.....119/1	13712-18.....129
13220-21.....105	13320-20.....108	13414-20.....113	13474-24.....119/1	13712-20.....129
13221-12.....105	13320-22.....108	13415-14.....113	13474-26.....119/1	13720-18.....130
13221-14.....105	13320-24.....108	13415-18.....113	13475-14.....119/1	15101-09.....132
13221-18.....105	13320-26.....108	13416-18.....113	13475-18.....119/1	15103-07.....132
13221-21.....105	13320-30.....108	13420-14.....114	13477-15.....119/2	15103-09.....132
13222-12.....105	13321-13.....108	13421-01.....114	13477-19.....119/2	15105-09.....132
13223-12.....105	13321-14.....108	13421-02.....114	13479-22.....119/2	15107-10.....132
13224-12.....105	13321-16.....108	13421-03.....114	13479-25.....119/2	15107-13.....132
13225-12.....105	13321-18.....108	13421-04.....114	13479-28.....119/2	15108-14.....132
13226-12.....105	13321-20.....108	13421-05.....114	13480-15.....119/2	15111-09.....132
13227-12.....105	13321-22.....108	13421-06.....114	13480-18.....119/2	15111-11.....132
13230-12.....105	13321-24.....108	13421-07.....114	13481-15.....119/2	15111-13.....132
13230-14.....105	13321-26.....108	13422-00.....114	13481-18.....119/2	15111-15.....132
13230-18.....105	13321-30.....108	13422-01.....114	13491-19.....119/2	15115-11.....132
13230-21.....105	13322-14.....108	13422-02.....114	13493-23.....120	15117-13.....132
13231-12.....105	13322-16.....108	13422-03.....114	13495-18.....120	15121-11.....133
13231-14.....105	13323-14.....108	13422-06.....114	13497-20.....120	15121-13.....133
13231-18.....105	13323-16.....108	13425-02.....114	13499-16.....120	15123-11.....133
13231-21.....105	13330-13.....109	13425-03.....114	13501-23.....120	15123-13.....133
13232-12.....105	13330-15.....109	13425-04.....114	13503-21.....121	15125-14.....133
13233-12.....105	13330-18.....109	13425-05.....114	13505-21.....121	15140-16.....133
13240-14.....106	13330-20.....109	13425-06.....114	13507-22.....121	15150-19.....133
13241-14.....106	13331-13.....109	13428-21.....115	13507-23.....121	15161-18.....133
13242-16.....106	13331-15.....109	13431-13.....115	13513-23.....122	15164-15.....133
13243-16.....106	13331-18.....109	13431-16.....115	13515-23.....122	15164-20.....133
13244-14.....106	13331-20.....109	13431-18.....115	13517-23.....122	17110-20.....134
13245-14.....106	13340-16.....109	13431-20.....115	13519-20.....122	17110-25.....134
13250-14.....107	13340-20.....109	13431-23.....115	13519-22.....122	17111-20.....134
13250-18.....107	13341-16.....109	13431-25.....115	13519-24.....122	17111-25.....134
13251-14.....107	13341-20.....109	13431-28.....115	13520-23.....122	17112-20.....134
13251-18.....107	13345-12.....109	13432-19.....116	13520-24.....122	17112-25.....134
13254-14.....107	13345-14.....109	13433-19.....116	13523-23.....123	17113-20.....134
13255-14.....107	13350-16.....109	13434-28.....116	13551-14.....123	17113-25.....134
13256-14.....106	13350-20.....109	13435-28.....116	13551-18.....123	17120-28.....134
13257-14.....106	13351-16.....109	13438-01.....116	13551-20.....123	17121-28.....134
13258-16.....106	13351-20.....109	13438-02.....116	13554-21.....123	17131-21.....134
13259-16.....106	13356-15.....109	13438-03.....116	13555-21.....123	17133-17.....135
13260-14.....107	13358-15.....109	13438-04.....116	13556-24.....123	17160-22.....135
13261-14.....107	13358-20.....109	13441-01.....117	13561-20.....123	17160-25.....135
13262-16.....107	13360-15.....110	13441-02.....117	13563-20.....123	17161-22.....135
13263-16.....107	13364-14.....110	13441-03.....117	13570-23.....124	17161-25.....135
13264-16.....107	13366-19.....110	13441-04.....117	13571-25.....124	17170-18.....136
13265-16.....107	13368-14.....110	13442-21.....117	13573-22.....124	17170-20.....136
13270-14.....106	13368-16.....110	13442-26.....117	13574-24.....125	17170-25.....136
13271-14.....106	13370-13.....110	13443-21.....117	13575-24.....125	17171-18.....136
13310-13.....108	13372-13.....110	13443-26.....117	13579-21.....125	17171-20.....136
13310-14.....108	13374-14.....110	13444-21.....117	13580-60.....126	17171-25.....136
13310-16.....108	13376-16.....110	13444-26.....117	13580-80.....126	17172-18.....136
13310-18.....108	13377-25.....111	13445-21.....117	13591-20.....126	17172-25.....136
13310-20.....108	13377-26.....111	13445-26.....117	13593-20.....126	17173-18.....136
13310-22.....108	13380-15.....111	13447-20.....117	13595-10.....127	17173-25.....136
13310-24.....108	13381-15.....111	13448-22.....117	13595-20.....127	17174-25.....136
13310-26.....108	13382-15.....111	13449-22.....117	13595-30.....127	17175-25.....136
13310-30.....108	13383-15.....111	13450-24.....118	13595-40.....127	17180-18.....136

17180-25.....	136	19171-40.....	143	19229-02.....	150	19299-01.....	156	19372-22.....	163
17207-13.....	137	19171-50.....	143	19229-03.....	150	19300-02.....	156	19374-45.....	163
17210-13.....	137	19171-60.....	143	19230-10.....	151	19300-03.....	156	19374-55.....	163
17210-16.....	137	19171-70.....	143	19230-12.....	151	19300-04.....	156	19374-65.....	163
17210-18.....	137	19172-30.....	143/1	19230-14.....	151	19300-06.....	156	19378-25.....	163
17220-25.....	137	19173-20.....	143/1	19230-16.....	151	19301-02.....	156	19380-35.....	163
17226-25.....	137	19173-30.....	143/1	19230-18.....	151	19301-03.....	156	19380-50.....	163
17227-25.....	137	19173-40.....	143/1	19231-11.....	151	19301-04.....	156	19381-50.....	163
17229-25.....	137	19174-17.....	143/1	19231-13.....	151	19301-06.....	156	19382-50.....	163
17230-26.....	138	19174-25.....	143/1	19231-15.....	151	19302-01.....	157	19385-38.....	164
17231-26.....	138	19174-37.....	143/1	19232-08.....	151	19302-02.....	157	19385-57.....	164
17233-26.....	138	19174-40.....	143/1	19232-10.....	151	19302-03.....	157	19388-40.....	164
19102-12.....	139	19175-28.....	143/1	19232-12.....	151	19302-04.....	157	19388-50.....	164
19102-15.....	139	19176-25.....	143/2	19232-14.....	151	19302-05.....	157	19388-65.....	164
19104-15.....	139	19177-27.....	143/2	19232-16.....	151	19302-06.....	157	19400-01.....	165
19110-13.....	139	19178-28.....	143/2	19232-18.....	151	19304-19.....	157	19400-02.....	165
19110-18.....	139	19179-28.....	144	19233-08.....	152	19306-20.....	157	19400-03.....	165
19120-00.....	139	19180-19.....	145	19233-11.....	152	19307-01.....	157	19480-22.....	164
19120-14.....	139	19181-22.....	145	19233-15.....	152	19307-02.....	157	19480-27.....	164
19120-15.....	139	19181-25.....	145	19233-17.....	152	19310-01.....	158	19482-45.....	164
19120-17.....	139	19183-25.....	145	19233-20.....	152	19310-02.....	158	19482-73.....	164
19122-13.....	140	19185-25.....	145	19233-23.....	152	19310-03.....	158	19482-82.....	164
19123-11.....	140	19187-25.....	145	19234-20.....	153	19310-04.....	158	19484-01.....	164
19124-15.....	140	19187-38.....	146	19235-21.....	153	19310-05.....	158	19484-02.....	164
19125-14.....	140	19187-50.....	146	19236-01.....	153	19312-01.....	158	19490-22.....	166
19126-13.....	140	19187-75.....	146	19236-02.....	153	19312-02.....	158	19490-43.....	166
19127-11.....	140	19189-25.....	146	19236-08.....	152	19312-03.....	158	19490-65.....	166
19131-21.....	141	19189-38.....	146	19236-10.....	152	19312-04.....	158	19492-25.....	164
19132-15.....	141	19189-50.....	146	19236-12.....	152	19312-05.....	158	19493-80.....	167
19134-20.....	141	19189-75.....	146	19236-14.....	152	19314-07.....	159	19494-00.....	167
19135-19.....	141	19190-64.....	147	19236-16.....	152	19314-10.....	159	19494-12.....	167
19137-16.....	141	19191-25.....	147	19236-18.....	152	19314-12.....	159	19494-13.....	167
19140-00.....	142	19191-40.....	147	19240-10.....	153	19314-14.....	159	19494-14.....	167
19140-01.....	142	19191-62.....	147	19240-20.....	153	19314-15.....	159	19494-16.....	167
19140-02.....	142	19192-23.....	147	19250-16.....	153	19314-16.....	159	19494-18.....	167
19150-01.....	142	19195-01.....	148	19250-24.....	153	19314-20.....	159	19494-45.....	166
19150-02.....	142	19195-02.....	148	19270-02.....	153	19315-06.....	159	19494-60.....	166
19150-03.....	142	19195-03.....	148	19270-03.....	153	19315-21.....	159	19494-75.....	166
19150-04.....	142	19210-12.....	149	19270-04.....	153	19317-21.....	159	19495-60.....	167
19152-25.....	142	19211-12.....	149	19270-06.....	153	19318-40.....	159	19495-80.....	167
19152-31.....	142	19212-01.....	149	19271-02.....	153	19318-57.....	159	19496-00.....	167
19152-38.....	142	19212-02.....	149	19271-03.....	153	19318-78.....	159	19496-12.....	167
19152-51.....	142	19214-13.....	149	19271-04.....	153	19330-40.....	158	19496-14.....	167
19152-64.....	142	19214-18.....	149	19271-06.....	153	19330-55.....	158	19496-50.....	166
19158-51.....	142	19215-01.....	149	19280-01.....	154	19332-19.....	160	19496-90.....	166
19158-64.....	142	19215-02.....	149	19280-02.....	154	19332-21.....	160	19497-14.....	167
19158-76.....	142	19215-03.....	149	19280-03.....	154	19340-10.....	160	19498-01.....	167
19158-82.....	142	19215-13.....	149	19280-04.....	154	19340-15.....	160	19498-02.....	167
19159-50.....	142	19215-18.....	149	19280-06.....	154	19340-20.....	160	19498-03.....	167
19159-64.....	142	19216-01.....	149	19281-01.....	154	19344-14.....	160	19610-07.....	168
19159-70.....	142	19216-02.....	149	19281-02.....	154	19344-20.....	160	19611-07.....	168
19159-90.....	142	19216-05.....	149	19281-03.....	154	19344-26.....	160	19620-07.....	168
19160-17.....	143	19216-07.....	149	19281-04.....	154	19345-01.....	160	19620-10.....	168
19161-17.....	143	19216-10.....	149	19281-06.....	154	19345-02.....	160	19621-07.....	168
19168-06.....	143	19217-03.....	149	19282-02.....	154	19345-03.....	160	19621-10.....	168
19168-08.....	143	19217-05.....	149	19282-03.....	154	19348-22.....	160	19630-10.....	168
19168-10.....	143	19217-07.....	149	19282-04.....	154	19350-35.....	161	19631-10.....	168
19168-12.....	143	19220-01.....	150	19282-06.....	154	19350-60.....	161	19634-10.....	168
19168-17.....	143	19220-02.....	150	19296-01.....	155	19350-70.....	161	19635-10.....	168
19168-20.....	143	19220-03.....	150	19296-02.....	155	19360-04.....	162	19636-14.....	168
19168-25.....	143	19220-04.....	150	19296-03.....	155	19364-40.....	162	19637-14.....	168
19169-25.....	143	19221-01.....	150	19296-04.....	155	19364-50.....	162	19640-14.....	169
19170-20.....	143	19221-02.....	150	19296-06.....	155	19364-60.....	162	19641-14.....	169
19170-25.....	143	19221-03.....	150	19296-08.....	155	19364-70.....	162	19650-10.....	169
19170-32.....	143	19221-04.....	150	19297-01.....	155	19366-08.....	162	19651-10.....	169
19170-40.....	143	19226-02.....	150	19297-02.....	155	19367-08.....	162	19654-13.....	169
19170-45.....	143	19226-03.....	150	19297-03.....	155	19370-40.....	163	19655-13.....	169
19170-50.....	143	19226-04.....	150	19297-04.....	155	19370-50.....	163	19670-14.....	169
19170-65.....	143	19227-02.....	150	19297-06.....	155	19370-60.....	163	19670-16.....	169
19170-76.....	143	19227-03.....	150	19297-08.....	155	19370-75.....	163	19670-20.....	169
19171-30.....	143	19227-04.....	150	19298-01.....	156	19370-85.....	163	19670-24.....	169

19671-14.....	169	19724-55.....	179	19798-01.....	188	19960-01.....	197	21154-04.....	202
19671-16.....	169	19724-60.....	179	19798-02.....	188	19960-02.....	197	21154-05.....	202
19671-20.....	169	19725-40.....	179	19798-03.....	188	19960-03.....	197	21154-06.....	202
19671-24.....	169	19725-45.....	179	19798-04.....	188	19960-04.....	197	21160-04.....	202
19672-11.....	171	19725-50.....	179	19799-01.....	189	19960-05.....	197	21160-06.....	202
19673-11.....	171	19725-55.....	179	19799-02.....	189	19960-06.....	197	21160-07.....	202
19674-15.....	171	19725-60.....	179	19799-03.....	189	19970-01.....	198	21160-08.....	202
19675-00.....	170	19744-00.....	180	19799-04.....	189	19980-01.....	197	21160-10.....	202
19675-13.....	171	19744-17.....	180	19799-05.....	189	19980-02.....	197	21160-12.....	202
19676-00.....	170	19745-40.....	180	19799-06.....	189	19980-03.....	197	21160-14.....	202
19677-13.....	171	19745-45.....	180	19800-01.....	189/1	19980-04.....	197	21162-12.....	203
19677-19.....	170	19745-50.....	180	19800-02.....	189/1	19980-05.....	197	21190-14.....	203
19677-25.....	170	19745-55.....	180	19800-03.....	189/1	19980-06.....	197	21270-12.....	203
19677-32.....	170	19745-60.....	180	19800-04.....	189/1	19980-08.....	198	21270-14.....	203
19678-05.....	170	19745-65.....	180	19802-09.....	189/1	19990-18.....	198	21270-16.....	203
19678-06.....	170	19745-70.....	180	19802-11.....	189/1	19995-22.....	198	21270-18.....	203
19678-16.....	171	19747-45.....	180	19802-14.....	189/1	19995-38.....	198	21270-23.....	203
19679-20.....	172	19747-50.....	180	19802-16.....	189/1	19998-03.....	198	21272-12.....	203
19679-22.....	172	19747-55.....	180	19802-18.....	189/1	19998-05.....	198	21272-14.....	203
19680-19.....	172	19747-60.....	180	19803-14.....	189/1	21102-11.....	199	21272-16.....	203
19681-19.....	172	19747-65.....	180	19804-18.....	189/2	21102-13.....	199	21272-18.....	203
19681-21.....	172	19748-01.....	180	19805-18.....	189/2	21102-14.....	199	21272-23.....	203
19682-26.....	173	19748-02.....	180	19806-18.....	189/2	21102-16.....	199	21290-12.....	203
19683-26.....	173	19748-03.....	180	19810-22.....	190	21102-18.....	199	21290-14.....	203
19684-14.....	173	19748-04.....	180	19812-60.....	190	21102-20.....	199	21290-16.....	203
19684-16.....	173	19754-00.....	181	19813-00.....	191	21102-25.....	199	21290-18.....	203
19684-20.....	173	19758-85.....	181	19816-00.....	191	21104-11.....	199	21292-12.....	203
19684-26.....	173	19759-00.....	181	19820-01.....	195	21104-13.....	199	21292-14.....	203
19685-14.....	173	19760-14.....	181	19820-02.....	193, 195	21104-14.....	199	21292-16.....	203
19685-16.....	173	19762-16.....	181	19820-03.....	193, 195	21104-16.....	199	21292-18.....	203
19685-20.....	173	19764-18.....	182	19820-10.....	193, 195	21104-18.....	199	21310-15.....	203
19685-26.....	173	19764-20.....	182	19820-20.....	193, 194	21104-20.....	199	21320-12.....	203
19686-32.....	174	19764-25.....	182	19820-90.....	192, 193	21104-25.....	199	21320-18.....	203
19687-01.....	175	19765-01.....	183	19820-91.....	192, 193	21106-11.....	199	21331-25.....	203
19687-02.....	175	19765-02.....	183	19820-99.....	193	21106-13.....	199	21340-45.....	203
19688-01.....	175	19765-03.....	183	19821-01.....	193	21106-14.....	199	23104-00.....	204
19688-02.....	175	19765-04.....	183	19821-02.....	193	21106-16.....	199	23110-30.....	204
19689-01.....	175/1	19766-90.....	182	19821-03.....	193	21106-18.....	199	23110-35.....	204
19689-02.....	175/1	19767-01.....	184	19821-04.....	193, 195	21106-20.....	199	23110-40.....	204
19690-31.....	176	19767-02.....	184	19822-01.....	193	21106-25.....	199	23110-45.....	204
19692-32.....	176	19767-18.....	184	19822-02.....	193	21108-14.....	199	23110-50.....	204
19694-01.....	177	19770-01.....	186	19822-21.....	194	21109-18.....	199	23110-55.....	204
19694-02.....	177	19770-02.....	186	19822-22.....	194	21110-13.....	199	23110-60.....	204
19694-03.....	177	19770-03.....	186	19822-22L.....	194	21110-14.....	199	23123-30.....	204
19696-18.....	178	19770-04.....	186	19822-23.....	193	21110-16.....	199	23123-40.....	204
19698-18.....	178	19770-05.....	186	19822-24.....	193	21110-18.....	199	23123-50.....	204
19710-00.....	178	19771-00.....	185	19822-25.....	193, 194	21110-20.....	199	23125-11.....	204
19710-01.....	178	19771-01.....	185	19822-26.....	193, 194	21111-14.....	199	23128-19.....	204
19710-40.....	178	19771-02.....	185	19824-06.....	193, 194	21112-14.....	199	23140-02.....	204
19710-45.....	178	19771-03.....	185	19825-06.....	193, 194	21115-10.....	199	23150-10.....	205
19710-50.....	178	19772-00.....	185	19826-06.....	193, 194	21120-16.....	199	23150-12.....	205
19710-55.....	178	19772-03.....	185	19831-25.....	193, 194	21121-14.....	199	23150-14.....	205
19710-60.....	178	19780-01.....	186	19833-33.....	193, 194	21121-18.....	199	23150-16.....	205
19711-00.....	178	19781-55.....	185	19834-01.....	193, 194	21122-13.....	199	23150-18.....	205
19711-01.....	178	19781-65.....	185	19902-10.....	267	21122-18.....	199	23150-20.....	205
19711-40.....	178	19782-00.....	185	19903-00.....	267	21125-01.....	200	23170-25.....	205
19711-45.....	178	19783-00.....	187	19910-00.....	196	21125-02.....	200	23170-30.....	205
19711-50.....	178	19783-01.....	187	19911-00.....	196	21125-03.....	200	23170-33.....	205
19711-55.....	178	19783-24.....	185	19912-50.....	196	21125-04.....	200	23170-35.....	205
19711-60.....	178	19784-30.....	187/1	19912-70.....	196	21150-00.....	201	23180-27.....	205
19712-00.....	178	19784-40.....	187/1	19913-50.....	196	21150-02.....	201	23180-40.....	205
19713-00.....	178	19784-50.....	187/1	19913-70.....	196	21150-03.....	201	23181-40.....	205
19720-00.....	179	19784-60.....	187/1	19914-41.....	196	21150-06.....	201	23195-08.....	207
19720-15.....	179	19784-78.....	187/1	19914-67.....	196	21150-09.....	201	23195-10.....	207
19721-00.....	179	19784-80.....	187/1	19915-48.....	196	21150-12.....	201	23195-12.....	207
19721-15.....	179	19784-98.....	187/1	19915-64.....	196	21150-15.....	201	23195-14.....	207
19724-00.....	179	19784-99.....	187/1	19916-64.....	196	21150-80.....	201	23195-16.....	207
19724-11.....	179	19790-01.....	187	19916-80.....	196	21150-90.....	201	23195-18.....	207
19724-40.....	179	19790-02.....	187	19917-64.....	196	21154-01.....	202	23197-08.....	207
19724-45.....	179	19795-01.....	188	19918-64.....	196	21154-02.....	202	23197-10.....	207
19724-50.....	179	19795-02.....	188	19918-88.....	196	21154-03.....	202	23197-12.....	207

23197-14.....	207	25184-24.....	209	25436-13.....	212	27120-24.....	218	27423-02.....	222
23197-16.....	207	25184-26.....	209	25438-13.....	212	27120-27.....	218	27423-03.....	222
23197-18.....	207	25184-30.....	209	25438-15.....	213	27121-21.....	218	27423-04.....	222
23198-08.....	207	25190-16.....	209	25446-25.....	213	27121-24.....	218	27423-05.....	222
23198-10.....	207	25190-18.....	209	25447-25.....	213	27121-27.....	218	27423-06.....	222
23198-12.....	207	25190-20.....	209	25450-14.....	213	27130-13.....	219	27423-07.....	222
23198-14.....	207	25194-16.....	209	25450-17.....	213	27131-13.....	219	27423-08.....	222
23198-16.....	207	25194-18.....	209	25450-20.....	213	27133-24.....	219	27423-09.....	222
23198-18.....	207	25194-20.....	209	25450-24.....	213	27134-32.....	219	27433-01.....	222
23210-00.....	206	25196-13.....	209	25452-14.....	213	27135-24.....	219	27433-02.....	222
23250-20.....	206	25196-18.....	209	25452-17.....	213	27139-19.....	219	27433-03.....	222
23250-40.....	206	25214-16.....	210	25452-20.....	213	27201-15.....	220	27433-04.....	222
23302-01.....	206	25214-18.....	210	25452-24.....	213	27201-19.....	220	27433-05.....	222
23302-02.....	206	25214-20.....	210	25460-18.....	213	27201-21.....	220	27433-06.....	222
23302-03.....	206	25214-23.....	210	25460-20.....	213	27202-15.....	220	27433-07.....	222
23302-04.....	206	25214-26.....	210	25460-23.....	213	27202-19.....	220	27433-08.....	222
23302-05.....	206	25214-31.....	210	25465-20.....	213	27202-21.....	220	27433-09.....	222
23302-06.....	206	25224-13.....	210	25465-25.....	213	27203-15.....	220	27433-10.....	222
23302-07.....	206	25224-15.....	210	25466-17.....	213	27203-19.....	220	27433-11.....	222
23302-08.....	206	25224-18.....	210	25466-20.....	213	27203-21.....	220	27433-12.....	222
23310-14.....	206	25224-20.....	210	25467-17.....	213	27204-15.....	220	27433-13.....	222
23310-18.....	206	25224-23.....	210	25467-20.....	213	27204-19.....	220	27433-14.....	222
23330-14.....	206	25224-26.....	210	25610-11.....	214	27204-21.....	220	27433-15.....	222
23330-20.....	206	25225-13.....	210	25612-13.....	214	27240-00.....	220	27433-16.....	222
23350-20.....	206	25225-15.....	210	25612-15.....	214	27240-01.....	220	27434-01.....	222
23350-30.....	206	25225-18.....	210	25614-12.....	214	27240-02.....	220	27434-02.....	222
23351-20.....	206	25225-20.....	210	25615-12.....	214	27240-03.....	220	27434-03.....	222
23351-30.....	206	25225-23.....	210	25620-16.....	214	27271-19.....	221	27434-04.....	222
23352-15.....	206	25225-26.....	210	25621-16.....	214	27273-19.....	221	27434-05.....	222
23352-20.....	206	25230-18.....	210	25624-16.....	214	27275-30.....	221	27434-06.....	222
25110-12.....	208	25230-20.....	210	25625-16.....	214	27277-25.....	221	27434-07.....	222
25114-12.....	208	25230-23.....	210	25627-14.....	214	27285-20.....	221	27434-08.....	222
25120-12.....	208	25241-21.....	210	25628-14.....	214	27288-22.....	221	27434-09.....	222
25122-12.....	208	25241-26.....	210	25650-10.....	216	27289-22.....	221	27434-10.....	222
25128-13.....	208	25245-21.....	210	25651-10.....	216	27291-18.....	221	27434-11.....	222
25129-13.....	208	25245-26.....	210	25656-10.....	216	27291-27.....	221	27434-12.....	222
25130-13.....	208	25250-27.....	210	25657-10.....	216	27297-23.....	221	27434-13.....	222
25134-13.....	208	25254-27.....	210	25660-13.....	217	27298-23.....	221	27434-14.....	222
25136-11.....	208	25260-27.....	210	25661-13.....	217	27403-01.....	222	27434-15.....	222
25137-11.....	208	25264-27.....	210	25667-18.....	215	27403-02.....	222	27434-16.....	222
25140-13.....	208	25285-20.....	211	25667-21.....	215	27403-03.....	222	27441-01.....	223
25144-13.....	208	25285-24.....	211	25668-18.....	215	27403-04.....	222	27441-02.....	223
25146-13.....	208	25285-26.....	211	25668-21.....	215	27403-05.....	222	27441-03.....	223
25148-13.....	208	25290-18.....	211	25670-14.....	215	27403-06.....	222	27441-04.....	223
25150-12.....	208	25292-18.....	211	25671-14.....	215	27403-07.....	222	27441-05.....	223
25150-14.....	208	25293-27.....	211	25672-14.....	215	27403-08.....	222	27441-06.....	223
25150-15.....	208	25311-20.....	211	25673-14.....	215	27403-09.....	222	27441-07.....	223
25150-16.....	209	25311-27.....	211	25676-14.....	215	27403-10.....	222	27441-08.....	223
25160-15.....	209	25315-20.....	211	25677-14.....	215	27403-11.....	222	27441-09.....	223
25160-18.....	209	25315-27.....	211	25678-09.....	215	27403-12.....	222	27441-10.....	223
25160-20.....	209	25324-18.....	211	25678-14.....	216	27403-13.....	222	27441-11.....	223
25160-23.....	209	25324-26.....	211	25679-09.....	215	27403-14.....	222	27441-12.....	223
25164-15.....	209	25330-21.....	212	25679-14.....	216	27403-15.....	222	27443-01.....	223
25164-18.....	209	25330-23.....	212	25680-13.....	215	27403-16.....	222	27443-02.....	223
25164-20.....	209	25334-23.....	212	25684-13.....	215	27413-01.....	222	27443-03.....	223
25164-23.....	209	25405-12.....	212	25700-18.....	217	27413-02.....	222	27443-04.....	223
25170-15.....	209	25406-12.....	212	25701-18.....	217	27413-03.....	222	27443-05.....	223
25174-15.....	209	25407-12.....	212	25720-14.....	217	27413-04.....	222	27443-10.....	223
25180-12.....	209	25408-12.....	212	25721-14.....	217	27413-05.....	222	27443-20.....	223
25180-14.....	209	25410-14.....	212	25722-14.....	217	27413-06.....	222	27443-30.....	223
25180-16.....	209	25410-17.....	212	25723-14.....	217	27413-07.....	222	27450-01.....	223
25180-18.....	209	25414-14.....	212	25730-18.....	217	27413-08.....	222	27450-02.....	223
25180-20.....	209	25414-17.....	212	25731-18.....	217	27413-09.....	222	27450-03.....	223
25180-24.....	209	25414-18.....	212	27109-20.....	218	27413-10.....	222	27450-04.....	223
25180-26.....	209	25415-14.....	212	27110-21.....	218	27413-11.....	222	27450-05.....	223
25180-30.....	209	25415-17.....	212	27110-24.....	218	27413-12.....	222	27450-06.....	223
25184-12.....	209	25415-20.....	212	27110-27.....	218	27413-13.....	222	27452-01.....	223
25184-14.....	209	25430-16.....	212	27111-21.....	218	27413-14.....	222	27452-02.....	223
25184-16.....	209	25434-11.....	212	27111-24.....	218	27413-15.....	222	27452-03.....	223
25184-18.....	209	25434-13.....	212	27111-27.....	218	27413-16.....	222	27452-04.....	223
25184-20.....	209	25434-16.....	212	27120-21.....	218	27423-01.....	222	27452-05.....	223

27452-06.....223	31210-50.....230	33245-23.....240	33412-24.....247	33477-03.....253
27465-10.....223	31210-65.....230, 231/2	33247-23.....240	33413-14.....247	33477-04.....253
27465-20.....223	31211-50.....230	33251-26.....240	33414-21.....247	33477-05.....253
27467-01.....223	31211-65.....230	33253-26.....240	33415-23.....248	33477-06.....253
27467-02.....223	31212-02.....230, 231-3	33257-23.....240	33415-25.....248	33478-98.....253
27467-03.....223	31250-00.....231	33258-23.....240	33415-28.....248	33478-99.....253
27467-04.....223	31350-28.....232	33259-23.....240	33416-17.....248	33479-00.....253
27467-05.....223	31360-30.....232	33260-24.....240	33417-18.....248	33479-01.....253
27475-10.....223	31362-28.....232	33261-22.....240	33420-20.....249	33479-02.....253
27475-20.....223	31366-23.....232	33274-14.....241	33421-20.....249	33479-03.....253
27477-01.....223	31370-20.....233	33274-17.....241	33423-23.....249	33479-04.....253
27477-02.....223	31380-18.....233	33274-19.....241	33424-10.....249	33479-05.....253
27477-03.....223	31390-18.....233	33274-22.....241	33441-13.....249	33479-06.....253
27477-04.....223	31395-18.....233	33275-14.....241	33441-18.....249	33480-97.....254
27477-05.....223	31397-24.....233	33275-17.....241	33441-20.....249	33480-98.....254
27485-10.....223	33100-01.....234	33275-19.....241	33442-19.....250	33481-00.....254
27485-20.....223	33100-02.....234	33275-22.....241	33443-18.....250	33481-01.....254
27487-01.....223	33101-12.....234	33280-15.....241	33444-15.....250	33481-02.....254
27487-02.....223	33101-14.....234	33281-15.....241	33450-01.....250	33481-03.....254
27487-03.....223	33102-01.....234	33282-19.....241	33450-02.....250	33481-04.....254
27487-04.....223	33102-02.....234	33283-17.....241	33467-97.....251	33481-05.....254
27487-05.....223	33103-14.....235	33284-15.....241	33467-98.....251	33481-06.....254
27610-12.....224	33105-17.....235	33286-18.....241	33468-00.....251	33482-01.....253
27612-12.....224	33107-16.....235	33289-18.....241	33468-01.....251	33482-02.....253
27614-12.....224	33109-16.....235	33290-23.....242	33468-02.....251	33482-03.....253
27616-12.....224	33115-15.....236	33290-27.....242	33468-03.....251	33482-97.....254
27620-18.....224	33117-15.....236	33291-23.....242	33468-04.....251	33482-98.....254
27630-12.....224	33119-15.....236	33291-27.....242	33469-96.....251	33483-00.....254
27640-13.....224	33131-15.....236	33292-26.....242	33469-97.....251	33483-01.....254
27642-14.....224	33133-15.....236	33293-27.....242	33469-98.....251	33483-02.....254
27660-07.....224	33136-17.....236	33295-24.....242	33470-00.....251	33483-03.....254
27660-11.....224	33137-17.....236	33360-21.....243	33470-01.....251	33483-04.....254
27660-12.....224	33142-20.....236	33362-21.....243	33470-02.....251	33483-05.....254
27660-14.....224	33143-20.....236	33365-19.....243	33470-03.....251	33483-06.....254
27660-16.....224	33147-20.....237	33366-19.....243	33470-04.....251	33484-97.....254
27660-18.....224	33148-18.....237	33366-23.....243	33470-05.....251	33484-98.....254
27660-20.....224	33150-16.....237	33366-26.....243	33470-06.....251	33485-00.....254
27660-22.....224	33151-16.....237	33368-26.....243	33471-96.....251	33485-01.....254
27670-00.....225	33152-17.....237	33370-22.....244	33471-97.....251	33485-02.....254
27680-00.....226	33153-17.....237	33370-27.....244	33471-98.....251	33485-03.....254
29102-16.....227	33154-18.....237	33370-30.....244	33472-00.....251	33485-04.....254
29102-20.....227	33155-18.....237	33372-22.....244	33472-01.....251	33485-05.....254
29102-24.....227	33156-18.....237	33372-26.....244	33472-02.....251	33485-06.....254
29110-27.....227	33157-02.....237	33372-33.....244	33472-03.....251	33485-21.....255
29120-20.....227	33157-03.....237	33378-15.....244	33472-04.....251	33485-99.....255
29120-28.....227	33157-04.....238	33378-17.....244	33472-05.....251	33486-00.....255
29121-20.....227	33157-05.....238	33378-21.....244	33472-06.....251	33486-01.....255
29121-28.....227	33157-06.....238	33380-15.....244	33473-01.....252	33486-02.....255
29130-23.....227	33158-03.....238	33380-17.....244	33473-02.....252	33486-99.....255
29140-20.....227	33158-04.....238	33380-21.....244	33473-03.....252	33487-00.....255
29140-30.....227	33158-05.....238	33382-33.....244	33473-04.....252	33487-01.....255
29145-55.....227	33159-03.....238	33382-45.....244	33473-05.....252	33487-02.....255
29150-12.....227, 624	33159-04.....238	33384-33.....244	33473-06.....252	33487-99.....255
29152-14.....227, 624	33159-05.....238	33384-45.....244	33474-96.....251	33488-00.....255
31101-24.....229	33201-18.....238	33391-15.....245	33474-97.....251	33488-01.....255
31103-23.....229	33202-18.....238	33391-19.....245	33474-98.....251	33488-02.....255
31103-26.....229	33205-18.....238	33391-24.....245	33475-00.....251	33489-00.....255
31103-37.....229	33211-15.....238	33391-26.....245	33475-01.....251	33489-01.....255
31120-19.....229	33213-15.....238	33391-28.....245	33475-02.....251	33489-02.....255
31130-14.....229	33216-18.....239	33395-17.....245	33475-03.....251	33489-03.....255
31201-11.....231/1	33217-18.....239	33395-25.....245	33475-04.....251	33490-10.....256
31201-22.....231/1	33219-23.....239	33395-26.....245	33475-05.....251	33490-20.....256
31201-39.....231/1, 231/3	33220-20.....239	33395-27.....245	33475-06.....251	33490-30.....256
31201-58.....231/1, 231/3	33230-22.....239	33402-17.....246	33476-01.....253	33490-40.....256
31202-16.....231/1, 231/3	33230-26.....239	33404-20.....246	33476-02.....253	33490-50.....256
31203-50.....231/2	33231-22.....239	33405-20.....246	33476-03.....253	33491-01.....256
31204-01.....231/2	33231-26.....239	33406-20.....246	33476-98.....253	33491-02.....256
31205-08.....231/2	33235-23.....239	33407-19.....246	33476-99.....253	33491-03.....256
31205-20.....231/2	33237-23.....239	33409-13.....246	33477-00.....253	33491-04.....256
31210-21.....230	33241-30.....240	33410-19.....246	33477-01.....253	33491-05.....256
31210-22.....230	33243-30.....240	33412-16.....247	33477-02.....253	33491-06.....256

33491-07.....	256	33620-07.....	259	33644-19.....	261	33660-15.....	263	33675-19.....	265
33491-08.....	256	33620-08.....	259	33644-25.....	261	33660-20.....	263	33675-25.....	265
33492-13.....	257	33622-02.....	259	33644-32.....	261	33660-25.....	263	33675-32.....	265
33492-16.....	257	33622-03.....	259	33645-06.....	261	33660-30.....	263	33676-01.....	266
33492-20.....	257	33622-04.....	259	33645-09.....	261	33661-07.....	263	33676-02.....	266
33494-13.....	257	33622-05.....	259	33645-13.....	261	33661-10.....	263	33676-05.....	266
33494-14.....	257	33622-06.....	259	33645-16.....	261	33661-15.....	263	33676-10.....	266
33494-17.....	257	33622-07.....	259	33645-19.....	261	33661-20.....	263	33676-16.....	266
33495-16.....	257	33622-08.....	259	33645-25.....	261	33661-25.....	263	33676-25.....	266
33496-00.....	257	33623-02.....	259	33645-32.....	261	33661-30.....	263	33677-05.....	266
33496-01.....	257	33623-03.....	259	33647-06.....	261	33664-04.....	263	33677-10.....	266
33496-12.....	257	33623-04.....	259	33647-09.....	261	33664-06.....	263	33677-16.....	266
33497-00.....	257	33623-05.....	259	33647-14.....	261	33664-08.....	263	33677-25.....	266
33498-00.....	257	33623-06.....	259	33647-16.....	261	33664-10.....	263	33678-24.....	267
33498-01.....	257	33623-07.....	259	33647-19.....	261	33664-12.....	263	33679-13.....	267
33498-12.....	257	33623-08.....	259	33647-25.....	261	33665-04.....	263	33680-22.....	267
33500-01.....	256	33625-02.....	259	33647-32.....	261	33665-06.....	263	33682-01.....	268
33500-02.....	256	33625-03.....	259	33649-09.....	261	33665-08.....	263	33682-02.....	268
33500-03.....	256	33625-04.....	259	33649-14.....	261	33665-10.....	263	33682-22.....	267
33509-03.....	258	33625-05.....	259	33649-16.....	261	33665-12.....	263	33683-01.....	268
33509-05.....	258	33625-06.....	259	33649-19.....	261	33665-24.....	264	33683-02.....	268
33509-08.....	258	33625-07.....	259	33649-25.....	261	33665-26.....	264	33683-03.....	268
33510-12.....	258	33625-08.....	259	33649-32.....	261	33665-55.....	264	33683-04.....	268
33510-14.....	258	33626-25.....	260	33650-04.....	261	33665-90.....	264	33683-05.....	268
33510-16.....	258	33626-35.....	260	33650-06.....	261	33666-22.....	264	33683-06.....	268
33600-02.....	259	33627-04.....	260	33650-08.....	261	33668-03.....	265	33684-00.....	269
33600-03.....	259	33627-06.....	260	33650-10.....	261	33668-05.....	265	33686-25.....	270
33600-04.....	259	33628-03.....	260	33650-13.....	261	33668-06.....	265	33687-75.....	270
33600-05.....	259	33628-05.....	260	33650-16.....	261	33668-08.....	265	33688-45.....	270
33600-06.....	259	33630-06.....	260	33650-18.....	261	33668-09.....	265	33689-90.....	270
33600-08.....	259	33630-08.....	260	33650-20.....	261	33668-13.....	265	33690-22.....	270
33600-09.....	259	33630-10.....	260	33650-25.....	261	33668-16.....	265	33691-34.....	271
33600-10.....	259	33630-12.....	260	33650-30.....	261	33668-19.....	265	33692-26.....	271
33602-04.....	259	33630-15.....	260	33650-38.....	261	33669-05.....	264	33693-32.....	271
33602-06.....	259	33630-20.....	260	33650-44.....	261	33669-10.....	264	33693-33.....	271
33602-08.....	259	33630-25.....	260	33650-50.....	261	33669-15.....	264	33693-34.....	271
33602-10.....	259	33630-30.....	260	33651-04.....	261	33670-05.....	264	33694-01.....	270
33602-12.....	259	33631-10.....	260	33651-06.....	261	33670-06.....	265	33694-03.....	270
33602-14.....	259	33631-12.....	260	33651-08.....	261	33670-09.....	265	33695-40.....	271
33602-16.....	259	33631-15.....	260	33651-10.....	261	33670-10.....	264	33696-75.....	271
33604-04.....	259	33631-20.....	260	33651-13.....	261	33670-13.....	265	33698-98.....	271
33604-06.....	259	33631-25.....	260	33651-16.....	261	33670-15.....	264	33699-00.....	270
33604-08.....	259	33631-30.....	260	33651-18.....	261	33670-16.....	265	33699-17.....	271
33604-10.....	259	33632-06.....	260	33651-20.....	261	33670-19.....	265	33700-01.....	272
33604-12.....	259	33632-08.....	260	33651-25.....	261	33670-25.....	265	33700-01-01.....	272
33604-14.....	259	33632-10.....	260	33651-30.....	261	33670-32.....	265	33700-02.....	272
33604-16.....	259	33632-12.....	260	33651-38.....	261	33671-06.....	265	33700-03.....	272
33605-04.....	259	33632-15.....	260	33651-44.....	261	33671-09.....	265	33700-04.....	272
33605-06.....	259	33632-20.....	260	33651-50.....	261	33671-13.....	265	33700-05.....	273
33605-08.....	259	33632-25.....	260	33652-02.....	262	33671-16.....	265	33700-06.....	273
33605-10.....	259	33632-30.....	260	33652-03.....	262	33671-19.....	265	33700-07.....	273
33605-12.....	259	33633-06.....	260	33652-04.....	262	33671-25.....	265	33700-08.....	273
33605-14.....	259	33633-08.....	260	33652-06.....	262	33671-32.....	265	33702-15.....	274
33605-16.....	259	33633-10.....	260	33652-08.....	262	33672-06.....	265	33703-15.....	274
33610-04.....	259	33633-12.....	260	33652-10.....	262	33672-09.....	265	33704-01.....	274
33610-06.....	259	33633-15.....	260	33652-12.....	262	33672-13.....	265	33704-02.....	274
33610-08.....	259	33633-20.....	260	33652-15.....	262	33672-16.....	265	33705-05.....	274
33610-10.....	259	33633-25.....	260	33654-02.....	262	33672-19.....	265	33705-10.....	274
33610-12.....	259	33633-30.....	260	33654-03.....	262	33672-25.....	265	33705-15.....	274
33610-14.....	259	33634-06.....	260	33654-04.....	262	33672-32.....	265	33705-20.....	274
33611-04.....	259	33634-08.....	260	33654-06.....	262	33673-06.....	265	33705-25.....	274
33611-06.....	259	33634-10.....	260	33654-08.....	262	33673-09.....	265	33706-18.....	274
33611-08.....	259	33634-12.....	260	33654-10.....	262	33673-13.....	265	33707-17.....	275
33611-10.....	259	33634-15.....	260	33654-12.....	262	33673-16.....	265	33708-19.....	275
33611-12.....	259	33634-20.....	260	33654-15.....	262	33673-19.....	265	33709-21.....	275
33611-14.....	259	33634-25.....	260	33656-28.....	262	33673-25.....	265	33710-19.....	275
33620-02.....	259	33634-30.....	260	33657-28.....	262	33673-32.....	265	33711-16.....	276
33620-03.....	259	33644-06.....	261	33658-28.....	262	33675-06.....	265	33711-18.....	275
33620-04.....	259	33644-09.....	261	33659-28.....	262	33675-09.....	265	33711-20.....	275
33620-05.....	259	33644-13.....	261	33660-07.....	263	33675-13.....	265	33711-21.....	275
33620-06.....	259	33644-16.....	261	33660-10.....	263	33675-16.....	265	33712-16.....	276

33713-16.....	276	33803-05.....	284	34101-01.....	295	34320-10.....	302	34402-22.....	306
33713-17.....	276	33803-07.....	284	34101-02.....	295	34320-15.....	302	34402-23.....	306
33714-15.....	276	33803-43.....	285	34101-03.....	295	34320-20.....	302	34402-24.....	306
33715-20.....	276	33804-15.....	285	34101-04.....	295	34320-25.....	302	34402-25.....	306
33716-18.....	276	33805-22.....	285	34101-05.....	295	34320-27.....	302	34402-28.....	306
33717-19-01.....	277	33805-33.....	285	34101-06.....	295	34320-30.....	302	34402-30.....	306
33717-19-02.....	277	33807-24.....	285	34101-07.....	295	34320-32.....	302	34403-08.....	306
33718-16.....	277	33809-22.....	285	34105-01.....	296	34320-35.....	302	34403-10.....	306
33719-17.....	277	33810-24.....	286	34110-00.....	296	34320-40.....	302	34403-11.....	306
33720-19.....	277	33811-06.....	286	34112-00.....	296	34320-45.....	302	34403-12.....	306
33720-21.....	277	33811-08.....	286	34112-01.....	296	34320-50.....	302	34403-13.....	306
33721-17.....	278	33812-16.....	286/1	34112-02.....	296	34320-60.....	302	34403-14.....	306
33723-17.....	278	33813-12.....	286/1	34114-39.....	296	34320-70.....	302	34403-15.....	306
33725-17.....	278	33814-44.....	286/2	34116-30.....	296	34321-10.....	302	34403-16.....	306
33727-17.....	278	33814-65.....	286/2	34118-31.....	296	34321-15.....	302	34403-17.....	306
33728-24.....	278	33823-26.....	288	34120-23.....	296	34321-20.....	302	34403-18.....	306
33729-01.....	278	33825-26.....	288	34161-13.....	297	34321-25.....	302	34403-19.....	306
33729-02.....	278	33826-00.....	289	34162-13.....	297	34321-27.....	302	34403-20.....	306
33729-03.....	278	33826-01.....	289	34172-00.....	297	34321-30.....	302	34403-22.....	306
33729-04.....	278	33826-02.....	289	34172-01.....	297	34321-32.....	302	34403-23.....	306
33729-05.....	278	33826-03.....	289	34175-00.....	297	34321-35.....	302	34403-24.....	306
33729-06.....	278	33827-17.....	289	34175-01.....	297	34321-40.....	302	34403-25.....	306
33729-07.....	278	33828-21.....	290	34210-20.....	298	34321-45.....	302	34403-28.....	306
33729-24.....	278	33829-25.....	290	34212-25.....	298	34321-50.....	302	34403-30.....	306
33731-22.....	279	33830-23.....	290	34212-30.....	298	34321-60.....	302	34404-08.....	306
33733-22.....	279	33831-16.....	291	34212-35.....	298	34321-65.....	302	34404-09.....	306
33740-19.....	280	33832-01.....	291	34212-40.....	298	34321-70.....	302	34404-10.....	306
33741-18.....	280	33832-02.....	291	34214-05.....	298	34321-80.....	302	34404-11.....	306
33742-18.....	280	33832-03.....	291	34214-08.....	298	34321-90.....	302	34404-12.....	306
33743-18.....	280	33832-04.....	291	34214-10.....	298	34322-00.....	302	34404-13.....	306
33745-19.....	280	33832-05.....	291	34214-12.....	298	34322-11.....	302	34404-14.....	306
33746-19.....	280	33833-16.....	291	34214-16.....	298	34322-15.....	302	34404-15.....	306
33747-18.....	280	33910-17.....	292	34216-10.....	298	34322-20.....	302	34404-16.....	306
33748-20.....	280	33911-17.....	292	34216-15.....	298	34322-25.....	302	34404-17.....	306
33749-10.....	280	33913-17.....	292	34216-20.....	298	34322-27.....	302	34404-18.....	306
33749-13.....	280	33921-22.....	292	34220-24.....	298	34322-32.....	302	34404-19.....	306
33749-19.....	280	33923-22.....	292	34222-25.....	298	34322-35.....	302	34404-20.....	306
33754-17.....	282	33950-01.....	292	34222-30.....	298	34322-45.....	302	34404-22.....	306
33755-17.....	282	33950-02.....	292	34222-35.....	298	34392-14.....	304	34404-23.....	306
33756-17.....	282	33950-03.....	292	34230-28.....	298	34393-18.....	304	34404-24.....	306
33757-17.....	282	33950-04.....	292	34231-15.....	298	34393-21.....	304	34404-25.....	306
33758-01.....	281	33950-05.....	292	34232-00.....	298	34394-14.....	304	34404-28.....	306
33758-02.....	281	33960-15.....	292	34240-27.....	299	34401-08.....	306	34404-30.....	306
33758-04.....	280	33960-25.....	292	34241-00.....	299	34401-10.....	306	34405-08.....	306
33758-06.....	280	33960-45.....	292	34242-09.....	299	34401-11.....	306	34405-09.....	306
33758-08.....	280	33960-55.....	292	34242-14.....	299	34401-12.....	306	34405-10.....	306
33759-06.....	282	33961-15.....	292	34242-16.....	299	34401-13.....	306	34405-11.....	306
33759-12.....	282	33962-16.....	292	34242-22.....	299	34401-14.....	306	34405-12.....	306
33759-19.....	282	33963-12.....	293	34243-02.....	299	34401-15.....	306	34405-13.....	306
33759-25.....	282	33964-15.....	293	34244-10.....	299	34401-16.....	306	34405-14.....	306
33760-01.....	282	33964-19.....	293	34244-14.....	299	34401-17.....	306	34405-15.....	306
33760-02.....	282	33964-24.....	293	34244-16.....	299	34401-18.....	306	34405-16.....	306
33760-03.....	282	33965-15.....	293	34244-17.....	299	34401-20.....	306	34405-17.....	306
33761-21.....	282	33965-19.....	293	34246-00.....	299	34401-22.....	306	34405-18.....	306
33763-01.....	282	33965-24.....	293	34248-00.....	299	34401-23.....	306	34405-19.....	306
33763-02.....	282	33966-11.....	293	34250-00.....	299	34401-24.....	306	34405-20.....	306
33763-03.....	282	33966-15.....	293	34252-00.....	299	34401-25.....	306	34405-22.....	306
33763-04.....	282	33967-15.....	293	34270-00.....	299	34401-28.....	306	34405-23.....	306
33765-17.....	283	33967-20.....	294	34270-01.....	299	34401-30.....	306	34405-24.....	306
33767-19.....	283	33968-30.....	294	34280-00.....	300	34402-08.....	306	34405-25.....	306
33769-30.....	283	33968-60.....	294	34290-00.....	300	34402-10.....	306	34405-28.....	306
33771-71.....	283	33969-18.....	294	34295-00.....	300	34402-11.....	306	34405-30.....	306
33771-73.....	283	33969-23.....	294	34296-00.....	300	34402-12.....	306	34406-08.....	306
33801-08.....	284	33970-01.....	294	34296-05.....	300	34402-13.....	306	34406-09.....	306
33801-12.....	284	33970-02.....	294	34296-10.....	300	34402-14.....	306	34406-10.....	306
33801-18.....	284	33970-03.....	294	34296-15.....	300	34402-15.....	306	34406-11.....	306
33801-43.....	284	33971-24.....	294	34296-20.....	300	34402-16.....	306	34406-12.....	306
33801-70.....	284	33972-22.....	294	34296-25.....	301	34402-17.....	306	34406-13.....	306
33802-01.....	284	33973-27.....	294	34296-30.....	301	34402-18.....	306	34406-14.....	306
33802-02.....	284	33975-30.....	294	34296-35.....	301	34402-19.....	306	34406-15.....	306
33802-14.....	284	33977-28.....	294	34296-40.....	301	34402-20.....	306	34406-16.....	306





34432-14.....308	34438-12.....308	34444-24.....309	34480-03.....311	34555-18.....319
34432-16.....308	34438-14.....308	34444-25.....309	34492-01.....311	34555-20.....319
34432-18.....308	34438-16.....308	34444-28.....309	34492-02.....311	34556-18.....319
34432-20.....308	34438-18.....308	34444-30.....309	34492-03.....311	34558-32.....320
34432-22.....308	34438-20.....308	34444-32.....309	34502-16.....312	34559-47.....320
34432-23.....308	34438-24.....308	34444-35.....309	34502-21.....312	34560-57.....320
34432-24.....308	34438-25.....308	34445-12.....309	34514-18.....312	34570-01.....321
34432-26.....308	34438-28.....308	34445-14.....309	34514-27.....312	34570-02.....321
34432-28.....308	34438-30.....308	34445-16.....309	34515-01.....313	34573-35.....321
34432-30.....308	34438-32.....308	34445-18.....309	34515-02.....313	34583-60.....321
34433-08.....308	34438-35.....308	34445-20.....309	34515-09.....312	34584-60.....321
34433-10.....308	34439-12.....308	34445-24.....309	34515-10.....312	34585-60.....321
34433-12.....308	34439-14.....308	34445-25.....309	34515-11.....312	34588-01.....321
34433-14.....308	34439-16.....308	34445-28.....309	34515-12.....312	34588-02.....321
34433-16.....308	34439-18.....308	34445-30.....309	34515-13.....312	34588-03.....321
34433-18.....308	34439-20.....308	34445-32.....309	34515-15.....312	34590-00.....322
34433-20.....308	34439-24.....308	34445-35.....309	34515-20.....312	34590-01.....322
34433-22.....308	34439-25.....308	34446-12.....309	34518-01.....312	34590-02.....322
34433-23.....308	34439-28.....308	34446-14.....309	34518-02.....312	34596-29.....322
34433-24.....308	34439-30.....308	34446-16.....309	34518-03.....312	34596-37.....322
34433-26.....308	34439-32.....308	34446-18.....309	34519-01.....313	34596-42.....322
34433-28.....308	34439-35.....308	34446-20.....309	34519-02.....313	34596-49.....322
34433-30.....308	34440-12.....308	34446-24.....309	34520-02.....314	34597-06.....322
34434-08.....308	34440-14.....308	34446-25.....309	34520-03.....314	34597-07.....322
34434-10.....308	34440-16.....308	34446-28.....309	34520-04.....314	34597-08.....322
34434-12.....308	34440-18.....308	34446-30.....309	34520-05.....314	34597-09.....322
34434-14.....308	34440-20.....308	34446-32.....309	34520-06.....314	34597-10.....322
34434-16.....308	34440-24.....308	34446-35.....309	34520-07.....314	34597-11.....322
34434-18.....308	34440-25.....308	34447-12.....309	34520-08.....314	34597-12.....322
34434-20.....308	34440-28.....308	34447-14.....309	34520-09.....314	34597-13.....322
34434-22.....308	34440-30.....308	34447-16.....309	34520-10.....314	34597-14.....322
34434-23.....308	34440-32.....308	34447-18.....309	34520-12.....314	34597-15.....322
34434-24.....308	34440-35.....308	34447-20.....309	34520-15.....314	34597-16.....322
34434-26.....308	34441-12.....308	34447-24.....309	34528-01.....315	34597-17.....322
34434-28.....308	34441-14.....308	34447-25.....309	34528-02.....315	34597-18.....322
34434-30.....308	34441-16.....308	34447-28.....309	34528-03.....315	34597-19.....322
34435-08.....308	34441-18.....308	34447-30.....309	34530-28.....315	34597-20.....322
34435-10.....308	34441-20.....308	34447-32.....309	34531-21.....315	34612-00.....322
34435-12.....308	34441-24.....308	34447-35.....309	34533-17.....316	34613-00.....322
34435-14.....308	34441-25.....308	34450-08.....310	34534-15.....316	34615-00.....322
34435-16.....308	34441-28.....308	34450-10.....310	34534-18.....316	34617-00.....322
34435-18.....308	34441-30.....308	34450-12.....310	34535-16.....316	34620-25.....323
34435-20.....308	34441-32.....308	34450-14.....310	34536-14.....316	34624-01.....323
34435-22.....308	34441-35.....308	34450-15.....310	34537-19.....316	34624-02.....323
34435-23.....308	34442-12.....309	34450-18.....310	34538-01.....316	34624-03.....323
34435-24.....308	34442-14.....309	34450-20.....310	34538-02.....316	34624-04.....323
34435-26.....308	34442-16.....309	34450-22.....310	34538-03.....316	34628-01.....323
34435-28.....308	34442-18.....309	34450-25.....310	34539-01.....316	34628-02.....323
34435-30.....308	34442-20.....309	34450-30.....310	34539-02.....316	34628-15.....323
34436-12.....308	34442-24.....309	34460-08.....310	34539-03.....316	34628-25.....323
34436-14.....308	34442-25.....309	34460-10.....310	34540-01.....317	34628-35.....323
34436-16.....308	34442-28.....309	34460-12.....310	34540-02.....317	34629-01.....323
34436-18.....308	34442-30.....309	34460-14.....310	34540-16.....317	34632-25.....324
34436-20.....308	34442-32.....309	34460-15.....310	34540-18.....317	34634-25.....324
34436-24.....308	34442-35.....309	34460-16.....310	34541-23.....317	34634-35.....324
34436-25.....308	34443-12.....309	34460-20.....310	34542-15.....317	34637-23.....325
34436-28.....308	34443-14.....309	34460-22.....310	34543-23.....317	34639-22.....325
34436-30.....308	34443-16.....309	34460-25.....310	34544-18.....317	34640-18.....325
34436-32.....308	34443-18.....309	34460-30.....310	34545-22.....318	41011-15.....326
34436-35.....308	34443-20.....309	34470-08.....310	34546-16.....318	41011-19.....326
34437-12.....308	34443-24.....309	34470-10.....310	34546-18.....318	41015-23.....326
34437-14.....308	34443-25.....309	34470-12.....310	34548-18.....318	41015-26.....326
34437-16.....308	34443-28.....309	34470-14.....310	34549-14.....318	41017-23.....326
34437-18.....308	34443-30.....309	34470-15.....310	34550-13.....318	41017-26.....326
34437-20.....308	34443-32.....309	34470-16.....310	34550-18.....318	41019-14.....326
34437-24.....308	34443-35.....309	34470-20.....310	34551-17.....318	41020-00.....326
34437-25.....308	34444-12.....309	34470-22.....310	34552-16.....319	41025-01.....327
34437-28.....308	34444-14.....309	34470-25.....310	34554-15.....319	41025-02.....327
34437-30.....308	34444-16.....309	34470-30.....310	34554-18.....319	41026-35.....327
34437-32.....308	34444-18.....309	34480-01.....311	34554-20.....319	41026-50.....327
34437-35.....308	34444-20.....309	34480-02.....311	34555-15.....319	41027-00.....327

41028-00.....327	41244-19.....336	41306-07.....337/1	41512-03.....344	41604-58T.....349
41051-20.....328	41245-19.....336	41306-09.....337/1	41512-04.....344	41604-62.....349
41052-20.....328	41250-11.....336	41306-12.....337/1	41512-05.....344	41604-62T.....349
41053-20.....328	41250-15.....336	41307-00.....338	41513-01.....344	41604-79.....349
41054-20.....328	41250-18.....336	41307-03.....338	41513-02.....344	41604-79T.....349
41056-18.....328	41253-07.....336	41307-04.....338	41513-03.....344	41604-87.....349
41058-18.....328	41253-11.....336	41307-05.....338	41513-04.....344	41604-87T.....349
41061-16.....329	41253-15.....336	41307-06.....338	41513-05.....344	41605-10.....350
41064-16.....329	41253-18.....336	41401-16.....339	41514-01.....344	41605-10T.....350
41068-20.....329	41254-06.....337	41405-17.....339	41514-02.....344	41605-12.....350
41069-20.....329	41254-10.....337	41405-27.....339	41514-03.....344	41605-12T.....350
41070-29.....329	41254-13.....337	41406-01.....339	41514-04.....344	41605-13.....350
41074-23.....329/1	41254-16.....337	41406-02.....339	41514-05.....344	41605-13T.....350
41075-24.....329/1	41254-19.....337	41420-01.....340	41515-01.....344	41606-62.....350
41076-03.....329/1	41254-25.....337	41420-02.....340	41515-02.....344	41606-62T.....350
41076-04.....329/1	41254-32.....337	41420-03.....340	41515-03.....344	41606-65.....350
41076-05.....329/1	41254-38.....337	41421-01.....340	41515-04.....344	41606-65T.....350
41076-07.....329/1	41290-21.....337	41421-02.....340	41515-05.....344	41606-78.....350
41078-23.....329/2	41294-40.....337	41421-03.....340	41520-03.....344/1	41606-78T.....350
41079-21.....329/2	41295-06.....337	41422-01.....340	41520-05.....344/1	41606-84.....350
41080-19.....330	41295-07.....337	41422-02.....340	41522-03.....344/1	41606-84T.....350
41081-19.....330	41295-08.....337	41422-03.....340	41522-05.....344/1	41607-56.....350
41083-19.....330	41295-09.....337	41430-01.....340	41524-03.....344/1	41607-56T.....350
41085-20.....330	41295-10.....337	41430-02.....340	41524-05.....344/1	41607-57.....350
41090-33.....330	41295-11.....337	41430-03.....340	41526-03.....344/1	41607-57T.....350
41091-31.....330	41295-12.....337	41431-01.....340	41526-05.....344/1	41607-58.....350
41091-41.....330	41297-06.....337	41431-02.....340	41527-03.....344/1	41607-58T.....350
41092-30.....332	41297-07.....337	41431-03.....340	41527-05.....344/1	41607-59.....350
41092-40.....332	41297-08.....337	41432-01.....340	41529-03.....344/1	41607-59T.....350
41092-50.....332	41297-09.....337	41432-02.....340	41529-05.....344/1	41607-60.....350
41092-60.....332	41297-10.....337	41432-03.....340	41540-02.....344/2	41607-60T.....350
41092-70.....332	41297-11.....337	41440-01.....340	41540-03.....344/2	41607-72.....350
41094-00.....332	41297-12.....337	41440-02.....340	41540-04.....344/2	41607-72T.....350
41096-21.....332	41298-12.....337	41440-03.....340	41540-05.....344/2	41607-73.....350
41097-22.....331	41299-03.....336	41441-01.....340	41542-02.....344/2	41607-73T.....350
41141-25.....332	41299-05.....336	41441-02.....340	41542-03.....344/2	41607-82.....350
41143-21.....332	41299-07.....336	41441-03.....340	41542-04.....344/2	41607-82T.....350
41145-21.....332	41300-02.....337/1	41442-01.....340	41542-05.....344/2	41608-57.....350
41146-18.....332	41300-03.....337/1	41442-02.....340	41600-62.....349	41608-57T.....350
41146-24.....332	41300-04.....337/1	41442-03.....340	41600-62T.....349	41608-80.....350
41147-21.....332	41300-05.....337/1	41443-26.....341	41600-70.....349	41608-80T.....350
41149-22.....332	41301-15.....337/1	41445-25.....341	41600-70T.....349	41609-70.....350
41151-24.....332	41301-20.....337/1	41447-27.....341	41600-78.....349	41609-70T.....350
41155-20.....333	41301-25.....337/1	41448-02.....342	41600-78T.....349	41610-61.....351
41156-18.....333	41301-35.....337/1	41448-03.....342	41600-92.....349	41610-61T.....351
41158-01.....333	41302-01.....337/1	41448-04.....342	41600-92T.....349	41610-68.....351
41158-02.....333	41302-02.....337/1	41449-01.....342	41601-10.....349	41610-68T.....351
41158-03.....333	41303-09.....337/2	41449-02.....342	41601-10T.....349	41610-70.....351
41161-01.....333	41303-12.....337/2	41449-03.....342	41601-11.....349	41610-70T.....351
41161-02.....333	41303-15.....337/2	41451-01.....343	41601-11T.....349	41611-74.....351
41161-03.....333	41303-18.....337/2	41451-02.....343	41601-13.....349	41611-74T.....351
41161-04.....333	41303-25.....337/2	41451-03.....343	41601-13T.....349	41611-87.....351
41161-05.....333	41303-30.....337/2	41452-01.....343	41602-60.....349	41611-87T.....351
41210-23.....334	41303-45.....337/2	41452-02.....343	41602-60T.....349	41611-92.....351
41211-23.....334	41304-06.....338	41452-03.....343	41602-68.....349	41611-92T.....351
41213-23.....334	41304-08.....338	41453-01.....343	41602-68T.....349	41612-07.....351
41221-00.....334	41304-10.....338	41453-02.....343	41602-75.....349	41612-07T.....351
41222-00.....334	41305-05.....338	41453-03.....343	41602-75T.....349	41612-09.....351
41223-00.....334	41305-06.....338	41458-20.....343	41602-87.....349	41612-11.....351
41224-00.....334	41305-07.....338	41510-01.....344	41602-87T.....349	41612-11T.....351
41230-19.....335	41305-08.....338	41510-02.....344	41603-55.....349	41612-12.....351
41231-19.....335	41305-09.....338	41510-03.....344	41603-61.....349	41612-12T.....351
41232-19.....335	41305-10.....338	41510-04.....344	41603-61T.....349	41612-62.....351
41233-19.....335	41305-12.....338	41510-05.....344	41603-65.....349	41612-62T.....351
41234-19.....335	41305-14.....338	41511-01.....344	41603-65T.....349	41613-74.....352
41236-19.....335	41305-15.....338	41511-02.....344	41603-74.....349	41613-74T.....352
41237-19.....335	41305-18.....338	41511-03.....344	41603-74T.....349	41613-84.....352
41238-19.....335	41305-20.....338	41511-04.....344	41604-54.....349	41613-84T.....352
41239-19.....335	41305-25.....338	41511-05.....344	41604-54T.....349	41613-96.....352
41242-19.....336	41305-30.....338	41512-01.....344	41604-58.....349	41613-96T.....352
41243-19.....336	41306-05.....337/1	41512-02.....344		

41614-58.....	352	41627-33T.....	355	41647-11.....	358	41826-26...368/2 - 368/4		43228-12.....	373
41614-58T.....	352	41627-40.....	355	41648-07.....	358	41830-30...368 - 368/4		43231-12.....	373
41614-65.....	352	41627-40T.....	355	41648-09.....	358	41832-32...368/4		43233-13.....	373
41614-65T.....	352	41628-33.....	355	41648-11.....	358	41842-42...368 - 368/1		43240-01.....	373
41614-72.....	352	41628-33T.....	355	41649-07.....	359	41842-44...368/1		43240-02.....	373
41614-72T.....	352	41628-40.....	355	41649-09.....	359	41842-46...368/1		43240-03.....	373
41615-49.....	352	41628-40T.....	355	41649-11.....	359	41843-50...368 - 368/1		43240-04.....	373
41615-49T.....	352	41628-46.....	355	41650-07.....	359	41850-41...368 - 368/1		43245-12.....	373
41615-50.....	352	41628-46T.....	355	41650-09.....	359	41860-14.....	369	43251-12.....	373
41615-50T.....	352	41629-32.....	355	41650-11.....	359	41860-17.....	369	43253-12.....	373
41615-51.....	352	41629-32T.....	355	41651-07.....	359	41860-20.....	369	43256-12.....	373
41615-51T.....	352	41629-38.....	355	41651-09.....	359	41870-08.....	369	43258-12.....	373
41616-79.....	353	41629-38T.....	355	41651-11.....	359	41870-11.....	369	43262-12.....	373
41616-79T.....	353	41630-36.....	355	41652-07.....	359	41870-14.....	369	43271-11.....	373
41616-91.....	353	41630-36T.....	355	41652-09.....	359	41870-17.....	369	43273-13.....	373
41616-91T.....	353	41630-38.....	355	41652-11.....	359	41880-01...368 - 369		43304-12.....	374
41617-10.....	353	41630-38T.....	355	41653-18.....	360	41880-02...368 - 369		43305-12.....	374
41617-10T.....	353	41631-36.....	355	41654-18.....	360	41880-03.....	369	43308-12.....	374
41617-65.....	353	41631-36T.....	355	41655-18.....	360	43101-03.....	370	43309-12.....	374
41617-65T.....	353	41631-40.....	355	41656-18.....	360	43101-04.....	370	43310-13.....	374
41617-72.....	353	41631-40T.....	355	41657-17.....	360	43104-07.....	370	43311-13.....	374
41617-72T.....	353	41631-44.....	355	41657-21.....	360	43105-06.....	370	43314-13.....	374
41617-78.....	353	41631-44T.....	355	41657-23.....	360	43106-05.....	370	43321-12.....	374
41617-78T.....	353	41632-36.....	355	41658-17.....	360	43107-08.....	370	43325-13.....	374
41618-55.....	353	41632-36T.....	355	41658-21.....	360	43109-07.....	370	43327-12.....	374
41618-55T.....	353	41633-35.....	355	41658-23.....	360	43109-09.....	370	43330-13.....	374
41618-56.....	353	41633-35T.....	355	41659-17.....	360	43110-08.....	370	43331-11.....	374
41618-56T.....	353	41633-40.....	355	41659-21.....	360	43111-07.....	370	43332-12.....	374
41618-57.....	353	41633-40T.....	355	41659-23.....	360	43113-07.....	370	43334-12.....	374
41618-57T.....	353	41634-35.....	355	41660-17.....	360	43115-05.....	370	43336-12.....	374
41618-79.....	353	41634-35T.....	355	41660-21.....	360	43121-07.....	370	43340-13.....	374
41618-79T.....	353	41634-60.....	355	41660-23.....	360	43123-07.....	370	43342-12.....	374
41618-88.....	353	41634-60T.....	355	41661-40.....	361	43125-05.....	370	43351-01.....	375
41618-88T.....	353	41634-70.....	355	41661-50.....	361	43125-07.....	370	43351-02.....	375
41619-00.....	353	41634-70T.....	355	41662-50.....	361	43127-08.....	370	43351-03.....	375
41619-00T.....	353	41635-57.....	355	41663-01.....	361	43128-08.....	370	43353-13.....	375
41620-58.....	354	41635-57T.....	355	41663-02.....	361	43129-07.....	371	43355-13.....	375
41620-58T.....	354	41636-45.....	355	41664-10.....	362	43130-07.....	371	43357-13.....	375
41620-59.....	354	41636-45T.....	355	41664-14.....	362	43132-08.....	371	43363-01.....	375
41620-59T.....	354	41637-33.....	356	41665-10.....	362	43133-08.....	371	43363-02.....	375
41620-60.....	354	41637-33T.....	356	41665-14.....	362	43135-07.....	371	43370-12.....	375
41620-60T.....	354	41637-40.....	356	41666-00.....	362	43139-07.....	371	43372-13.....	375
41620-61.....	354	41637-40T.....	356	41667-30.....	363	43140-08.....	371	43373-13.....	375
41620-61T.....	354	41638-38.....	356	41667-50.....	363	43141-08.....	371	43376-13.....	375
41620-62.....	354	41638-38T.....	356	41668-50.....	363	43150-11.....	371	43377-13.....	375
41620-62T.....	354	41638-46.....	356	41669-50.....	363	43170-00.....	371	43380-13.....	375
41620-63.....	354	41638-46T.....	356	41670-50.....	363	43170-01.....	371	43381-13.....	375
41620-63T.....	354	41639-44.....	356	41672-01.....	364	43170-02.....	371	43383-13.....	375
41620-70.....	354	41639-44T.....	356	41672-02.....	364	43170-03.....	371	43386-13.....	375
41620-70T.....	354	41640-40.....	356	41672-03.....	364	43172-13.....	371	43387-02.....	376
41620-78.....	354	41640-40T.....	356	41672-04.....	364	43180-01.....	372	43388-02.....	376
41620-78T.....	354	41641-07.....	357	41674-50.....	365	43180-02.....	372	43389-02.....	376
41620-88.....	354	41641-09.....	357	41674-80.....	365	43180-03.....	372	43390-05.....	376
41620-88T.....	354	41641-11.....	357	41675-50.....	365	43181-01.....	372	43391-13.....	376
41621-58.....	354	41642-07.....	357	41675-80.....	365	43181-02.....	372	43402-05.....	377
41621-58T.....	354	41642-09.....	357	41676-50.....	365	43181-03.....	372	43402-10.....	377
41621-62.....	354	41642-11.....	357	41676-80.....	365	43183-13.....	372	43402-15.....	377
41621-62T.....	354	41643-07.....	357	41677-50.....	365	43185-13.....	372	43402-18.....	377
41622-58.....	354	41643-09.....	357	41677-80.....	365	43187-13.....	372	43402-20.....	377
41622-58T.....	354	41643-11.....	357	41678-50.....	365	43202-01.....	372	43402-25.....	377
41622-62.....	354	41644-07.....	357	41678-80.....	365	43202-02.....	372	43402-35.....	377
41622-62T.....	354	41644-09.....	357	41679-25.....	366	43202-03.....	372	43402-40.....	377
41623-56.....	354	41644-11.....	357	41680-00.....	366	43210-01.....	372	43402-45.....	377
41623-56T.....	354	41645-07.....	358	41801-01.....	368/2	43210-02.....	372	43404-10.....	377
41624-56.....	354	41645-09.....	358	41802-00.....	368	43210-03.....	372	43404-20.....	377
41624-56T.....	354	41645-11.....	358	41802-02.....	368/2	43213-12.....	372	43404-24.....	377
41625-56.....	354	41646-07.....	358	41803-01.....	368/2	43214-04.....	372	43404-30.....	377
41625-56T.....	354	41646-09.....	358	41807-00.....	368/3	43214-08.....	372	43404-35.....	377
41626-56.....	354	41646-11.....	358	41810-10.....	368 - 368/3	43218-12.....	373	43407-13.....	377
41626-56T.....	354	41647-07.....	358	41821-21...368/3 - 368/4		43221-11.....	373	43410-01.....	377
41627-33.....	355	41647-09.....	358	41822-22...368/2 - 368/4		43226-12.....	373	43410-02.....	377

43412-01.....	377	43830-10.....	383	44150-01.....	392	45014-45.....	399	45097-02.....	406
43412-02.....	377	43831-10.....	383	44150-03.....	392	45014-55.....	399	45097-03.....	406
43414-02.....	378	43833-10.....	383	44150-05.....	392	45014-65.....	399	45097-10.....	406
43420-01.....	378	43840-10.....	383	44150-10.....	392	45014-75.....	399	45097-15.....	406
43420-02.....	378	43841-10.....	383	44150-15.....	392	45015-00.....	399	45098-01.....	407
43420-03.....	378	43843-10.....	383	44151-05.....	392	45015-45.....	399	45098-02.....	407
43424-13.....	378	43850-08.....	383	44151-10.....	392	45015-55.....	399	45098-05.....	407
43441-01.....	378	43851-08.....	383	44151-15.....	392	45015-65.....	399	45098-10.....	407
43441-02.....	378	43852-08.....	383	44164-10.....	392	45015-75.....	399	45098-20.....	407
43443-13.....	378	43853-08.....	383	44166-07.....	392	45018-00.....	399	45098-50.....	407
43445-13.....	378	43855-07.....	384	44181-10.....	392	45018-50.....	399	45099-01.....	407
43447-13.....	378	43857-07.....	384	44190-08.....	392	45018-60.....	399	45099-02.....	407
43449-01.....	378	43861-07.....	384	44202-08.....	392	45018-70.....	399	45099-05.....	407
43449-02.....	378	43863-07.....	384	44210-10.....	392	45018-80.....	399	45099-10.....	407
43461-13.....	378	43865-07.....	384	44220-10.....	392	45020-01.....	400	45099-20.....	407
43462-13.....	378	43869-07.....	384	44240-09.....	393	45020-02.....	400	45099-50.....	407
43467-13.....	378	43881-07.....	384	44242-09.....	393	45020-03.....	400	45109-00.....	407
43482-20.....	378	43883-07.....	384	44246-09.....	393	45020-04.....	400	45110-00.....	407
43485-13.....	378	43885-07.....	384	44254-09.....	393	45030-04.....	401	45110-01.....	407
43487-14.....	378	43887-07.....	384	44256-09.....	393	45030-06.....	401	45110-02.....	407
43501-06.....	379	43891-09.....	385	44258-09.....	393	45030-07.....	401	45110-03.....	407
43501-10.....	379	43902-09.....	385	44265-10.....	393	45030-08.....	401	45110-04.....	407
43501-12.....	379	43903-09.....	385	44267-10.....	393	45030-10.....	401	45110-05.....	407
43511-13.....	379	43907-10.....	385	44274-11.....	393	45036-03.....	402	45111-00.....	407
43513-14.....	379	43909-10.....	385	44300-00.....	394	45036-06.....	402	45112-00.....	407
43515-14.....	379	43914-10.....	385	44301-00.....	394	45036-07.....	402	45112-01.....	407
43517-09.....	379	43916-10.....	385	44310-00.....	394	45036-08.....	402	45112-02.....	407
43521-12.....	379	43920-11.....	385	44311-00.....	394	45036-09.....	401	45112-03.....	407
43523-12.....	379	43924-11.....	386	44320-00.....	394	45036-10.....	401	45112-04.....	407
43524-10.....	379	43926-11.....	386	44330-00.....	394	45060-01.....	403	45112-05.....	407
43525-05.....	379	43940-05.....	386	44340-00.....	394	45060-02.....	403	45114-00.....	407
43525-07.....	379	43940-08.....	386	44350-00.....	394	45060-03.....	403	45115-00.....	407
43525-10.....	379	43942-05.....	386	44370-00.....	394/1	45060-04.....	403	45115-01.....	407
43526-12.....	379	43942-08.....	386	44371-00.....	394/1	45060-05.....	403	45115-02.....	407
43542-12.....	380	43944-07.....	387	44372-00.....	394/1	45061-00.....	403	45115-03.....	407
43544-12.....	380	43946-07.....	387	44373-00.....	394/1	45070-01.....	403	45115-04.....	407
43546-13.....	380	43948-10.....	387	44374-00.....	394/1	45070-02.....	403	45115-05.....	407
43548-13.....	380	43950-10.....	387	44380-00.....	394/2	45070-03.....	403	45116-00.....	407
43583-07.....	380	43952-10.....	387	44390-00.....	394/2	45070-04.....	403	45117-00.....	407
43589-13.....	380	43953-10.....	387	44404-00.....	394/2	45070-05.....	403	45117-01.....	407
43593-09.....	380	43955-10.....	387	44406-00.....	394/2	45070-06.....	403	45117-02.....	407
43602-01.....	381	43956-10.....	387	44408-00.....	395	45071-00.....	403	45117-03.....	407
43602-02.....	381	44015-20.....	389	44420-09.....	395	45072-01.....	404	45117-04.....	407
43602-03.....	381	44015-27.....	389	44422-09.....	395	45073-01.....	404	45117-05.....	407
43605-12.....	381	44017-08.....	389	44424-08.....	395	45073-02.....	404	45133-01.....	408
43605-34.....	381	44046-11.....	389	44425-10.....	395	45073-03.....	404	45133-02.....	408
43605-56.....	381	44050-11.....	389	44426-09.....	395	45073-04.....	404	45133-03.....	408
43608-12.....	381	44052-11.....	389	44428-09.....	395	45073-05.....	404	45133-04.....	408
43609-14.....	381	44054-09.....	389	45009-00.....	399	45073-06.....	404	45133-05.....	408
43610-01.....	381	44066-09.....	390	45009-02.....	399	45074-01.....	404	45150-18.....	408
43610-02.....	381	44067-09.....	390	45009-03.....	399	45075-00.....	404	45151-16.....	408
43613-00.....	381	44068-09.....	390	45009-04.....	399	45076-01.....	404	45152-01.....	408
43614-00.....	381	44069-09.....	390	45010-00.....	399	45080-00.....	405	45152-02.....	408
43614-01.....	381	44074-10.....	390	45010-20.....	399	45090-00.....	405	45153-16.....	408
43614-12.....	381	44076-05.....	390	45010-30.....	399	45090-02.....	405	45160-15.....	408
43614-23.....	381	44076-10.....	390	45010-45.....	399	45090-03.....	405	45162-18.....	408
43614-34.....	381	44078-05.....	390	45010-55.....	399	45090-04.....	405	45164-17.....	408
43614-45.....	381	44078-10.....	390	45010-65.....	399	45090-05.....	405	45165-17.....	408
43614-56.....	381	44101-07.....	390	45010-75.....	399	45090-06.....	405	45171-12.....	409
43614-67.....	381	44103-09.....	391	45011-00.....	399	45090-08.....	405	45180-01.....	409
43614-78.....	381	44106-10.....	391	45011-03.....	399	45091-00.....	406	45180-02.....	409
43802-07.....	382	44109-10.....	391	45011-04.....	399	45091-01.....	406	45180-03.....	409
43803-07.....	382	44111-10.....	391	45011-05.....	399	45091-02.....	406	45181-13.....	409
43804-07.....	382	44114-10.....	391	45011-07.....	399	45091-03.....	406	45184-16.....	409
43805-07.....	382	44115-10.....	391	45011-08.....	399	45091-04.....	406	45185-15.....	409
43810-10.....	382	44117-10.....	391	45012-00.....	399	45091-15.....	406	45190-01.....	409
43811-10.....	382	44119-10.....	391	45012-40.....	399	45091-17.....	406	45190-02.....	409
43813-10.....	382	44121-10.....	391	45012-55.....	399	45091-22.....	406	45192-01.....	409
43820-10.....	382	44125-06.....	391	45012-65.....	399	45096-50.....	406	45192-02.....	409
43821-10.....	382	44127-06.....	391	45012-75.....	399	45096-75.....	406	45192-03.....	409
43823-10.....	382	44129-07.....	391	45014-00.....	399	45097-01.....	406	45192-04.....	409

45192-05.....	409	45390-35.....	415	45743-10.....	419	47191-01.....	425	47332-30.....	433
45192-06.....	409	45390-50.....	415	45745-03.....	419	47191-02.....	425	47332-40.....	433
45193-01.....	409	45391-35.....	415	45745-06.....	419	47191-03.....	425	47338-20.....	433
45193-02.....	409	45392-35.....	415	45745-10.....	419	47191-04.....	425	47338-25.....	433
45193-03.....	409	45393-50.....	415	45747-03.....	419	47192-16.....	426	47338-30.....	433
45194-01.....	410	45394-50.....	415	45747-06.....	419	47195-01.....	426	47339-20.....	433
45194-02.....	410	45400-01.....	416	45747-10.....	419	47195-02.....	426	47339-25.....	433
45194-03.....	410	45400-02.....	416	45751-16.....	420	47197-01.....	426	47339-30.....	433
45194-04.....	410	45400-03.....	416	45753-16.....	420	47197-02.....	426	47340-15.....	433
45201-11.....	410	45401-25.....	416	45755-16.....	420	47223-01.....	426	47340-18.....	433
45201-13.....	410	45402-10.....	416	45757-16.....	420	47223-02.....	426	47340-20.....	433
45203-11.....	410	45403-13.....	416	45760-01.....	420	47223-03.....	426	47342-25.....	433
45204-14.....	410	45404-13.....	416	45760-02.....	420	47223-04.....	426	47342-30.....	433
45206-16.....	410	45410-01.....	417	45762-01.....	420	47223-05.....	426	47342-40.....	433
45208-14.....	410	45411-01.....	417	45762-02.....	420	47224-01.....	426	47343-00.....	433/1
45220-16.....	411	45412-01.....	417	45766-35.....	420	47224-02.....	426	47343-15.....	433/1
45222-17.....	411	45413-01.....	417	45766-40.....	420	47224-03.....	426	47343-17.....	433/1
45225-02.....	411	45414-01.....	417	45766-45.....	420	47224-04.....	426	47343-20.....	433/1
45243-14.....	411	45701-01.....	418	45766-50.....	420	47224-05.....	426	47343-25.....	433/1
45245-12.....	411	45701-02.....	418	45802-16.....	420	47235-05.....	427	47343-30.....	433/1
45246-12.....	411	45703-15.....	418	45803-16.....	420	47235-07.....	427	47344-15.....	433/1
45246-14.....	411	45704-15.....	418	45805-16.....	420	47235-09.....	427	47344-17.....	433/1
45251-10.....	412	45705-15.....	418	45807-20.....	420	47235-11.....	427	47344-20.....	433/1
45253-11.....	412	45706-35.....	418	47050-01.....	421	47237-01.....	427	47344-25.....	433/1
45255-08.....	412	45709-10.....	418	47050-02.....	421	47237-02.....	427	47344-30.....	433/1
45257-08.....	412	45709-14.....	418	47050-03.....	421	47237-03.....	427	47345-15.....	433/1
45261-08.....	412	45709-16.....	418	47050-04.....	421	47239-01.....	427	47347-20.....	433/1
45261-14.....	412	45709-20.....	418	47050-05.....	421	47239-02.....	427	47350-26.....	433/2
45261-16.....	412	45709-26.....	418	47050-06.....	421	47240-19.....	427	47351-26.....	433/2
45263-08.....	412	45709-28.....	418	47050-07.....	421	47242-00.....	427	47352-24.....	433/2
45263-14.....	412	45709-30.....	418	47060-01.....	421	47242-01.....	427	47355-03.....	433/2
45265-08.....	412	45710-15.....	419	47060-02.....	421	47251-21.....	428	47370-16.....	434
45267-20.....	412	45711-15.....	419	47060-03.....	421	47255-01.....	428	47371-16.....	434
45267-25.....	412	45713-15.....	419	47102-01.....	421	47255-02.....	428	47372-16.....	434
45267-30.....	412	45715-17.....	419	47102-02.....	421	47256-20.....	428	47373-16.....	434
45269-30.....	412	45720-03.....	419	47102-03.....	421	47303-03.....	428	47374-16.....	434
45271-08.....	412	45720-06.....	419	47103-01.....	422	47303-04.....	428	47375-16.....	434
45273-08.....	412	45720-10.....	419	47103-02.....	422	47303-05.....	428	47375-19.....	434
45275-08.....	412	45722-03.....	419	47103-03.....	422	47303-06.....	428	47376-16.....	435
45310-40.....	413	45722-06.....	419	47112-01.....	421	47304-01.....	429	47379-16.....	435
45312-55.....	413	45722-10.....	419	47112-02.....	421	47304-02.....	429	47380-15.....	435
45313-55.....	413	45722-12.....	419	47112-03.....	421	47304-03.....	429	47382-15.....	435
45315-55.....	413	45722-15.....	419	47113-03.....	421	47304-04.....	429	47384-15.....	435
45317-55.....	413	45722-20.....	419	47116-13.....	423	47305-01.....	429	47385-15.....	435
45320-70.....	413	45722-25.....	419	47118-13.....	423	47305-02.....	429	47386-01.....	435
45321-70.....	413	45724-03.....	419	47120-35.....	423	47305-03.....	429	47386-02.....	435
45322-70.....	413	45724-06.....	419	47120-50.....	423	47311-10.....	430	47387-01.....	435
45350-40.....	413	45724-10.....	419	47120-75.....	423	47311-25.....	430	47387-02.....	435
45350-70.....	413	45724-12.....	419	47120-90.....	423	47311-30.....	430	47390-03.....	436
45352-40.....	413	45724-15.....	419	47124-35.....	423	47315-00.....	430	47390-04.....	436
45353-60.....	413	45724-20.....	419	47124-50.....	423	47316-00.....	430	47390-05.....	436
45355-60.....	413	45724-25.....	419	47124-75.....	423	47316-16.....	431	47392-03.....	436
45357-40.....	413	45725-05.....	419	47124-90.....	423	47317-00.....	430	47392-04.....	436
45359-40.....	413	45725-10.....	419	47139-12.....	423	47317-11.....	431	47392-05.....	436
45360-35.....	413	45730-03.....	419	47139-14.....	423	47317-65.....	431	47410-04.....	437
45362-45.....	414	45730-06.....	419	47139-16.....	423	47317-70.....	431	47410-05.....	437
45363-45.....	414	45730-10.....	419	47139-18.....	423	47317-90.....	431	47410-16.....	437
45365-45.....	414	45732-03.....	419	47151-15.....	424	47318-11.....	431	47411-16.....	437
45367-50.....	414	45732-06.....	419	47151-18.....	424	47318-65.....	431	47413-19.....	437
45369-50.....	414	45732-10.....	419	47154-20.....	424	47318-70.....	431	47415-18.....	437
45370-50.....	414	45733-05.....	419	47155-20.....	424	47318-90.....	431	47417-19.....	437
45371-40.....	414	45733-10.....	419	47158-20.....	424	47319-35.....	432	47419-19.....	437
45373-30.....	414	45735-05.....	419	47159-20.....	424	47319-45.....	432	47420-01.....	438
45375-60.....	414	45735-10.....	419	47161-16.....	424	47323-19.....	430	47420-02.....	438
45377-60.....	414	45736-15.....	419	47161-20.....	424	47325-19.....	430	47420-03.....	438
45381-30.....	414	45737-15.....	419	47167-18.....	425	47331-20.....	433	47420-04.....	438
45383-30.....	414	45741-03.....	419	47169-18.....	425	47331-25.....	433	47420-20.....	438
45385-01.....	414	45741-06.....	419	47171-14.....	425	47331-30.....	433	47421-21.....	438
45385-02.....	414	45741-10.....	419	47173-14.....	425	47331-40.....	433	47421-23.....	439
45387-01.....	414	45743-03.....	419	47181-18.....	425	47332-20.....	433	47422-22.....	439
45387-02.....	414	45743-06.....	419	47185-18.....	425	47332-25.....	433	47423-22.....	439

47424-16.....	439	47522-09.....	445	49107-19.....	451	49360-10.....	459	51111-23.....	465
47425-19.....	439	47523-01.....	446	49108-15.....	451	49400-01.....	459	51131-22.....	465
47426-22.....	439	47523-02.....	446	49109-19.....	451	49501-22.....	459	51133-23.....	465
47428-21.....	439	47526-16.....	446	49110-19.....	452	49501-23.....	459	51134-21.....	465
47430-22.....	439	47527-16.....	446	49111-15.....	452	49501-24.....	459	51135-01.....	465
47450-04.....	439	47529-16.....	446	49115-01.....	452	49503-22.....	459	51135-02.....	465
47451-04.....	439	47532-19.....	446	49115-02.....	452	49503-23.....	459	51139-25.....	465
47454-04.....	440	47533-19.....	446	49117-11.....	452	49503-24.....	459	51143-24.....	466
47454-07.....	440	47534-19.....	446	49119-14.....	453	49605-07.....	460	51151-19.....	465
47454-09.....	440	47535-01.....	446	49230-11.....	453	49605-10.....	460	51165-22.....	466
47454-12.....	440	47535-02.....	446	49231-12.....	453	49605-11.....	460	51167-22.....	466
47455-06.....	440	47540-16.....	447	49231-14.....	453	49605-12.....	460	51168-23.....	466
47458-04.....	440	47541-14.....	447	49231-16.....	453	49605-14.....	460	51169-23.....	466
47458-07.....	440	47542-12.....	447	49235-19.....	453	49605-16.....	460	51170-24.....	466
47458-09.....	440	47551-16.....	447	49250-16.....	453	49610-12.....	460	51171-22.....	466
47458-12.....	440	47551-16L.....	447	49250-18.....	453	49610-13.....	460	51172-19.....	466
47460-04.....	440	47552-16.....	447	49255-16.....	453	49610-16.....	460	51173-21.....	466
47460-07.....	440	47553-15.....	447/1	49255-99.....	453	49613-10.....	461	51174-21.....	466
47460-12.....	440	47554-01.....	447/1	49265-12.....	454	49615-12.....	461	51177-23.....	466
47461-00.....	440	47554-02.....	447/1	49265-14.....	454	49620-15.....	461	51178-21.....	466
47463-10.....	440	47554-03.....	447/1	49267-12.....	454	49623-16.....	461	51179-17.....	466
47463-12.....	440	47555-08.....	447/1	49270-16.....	454	49627-01.....	461	51181-19.....	467
47463-14.....	440	47556-16.....	447/1	49270-19.....	454	49630-02.....	461	51183-19.....	467
47470-04.....	441	47557-17.....	447/1	49272-13.....	454	49635-18.....	462	51185-19.....	467
47470-05.....	441	47558-15.....	448	49274-09.....	454	49640-05.....	462	51187-19.....	467
47470-06.....	441	47559-20.....	448	49274-11.....	454	49640-07.....	462	51191-19.....	467
47470-07.....	441	47560-18.....	448	49274-13.....	454	49640-09.....	462	51193-19.....	467
47471-02.....	441	47562-18.....	448	49274-15.....	454	49650-06.....	462	51202-19.....	467
47471-03.....	441	47563-22.....	448	49287-02.....	455	49650-07.....	462	51203-19.....	467
47471-04.....	441	47564-16.....	448	49287-03.....	455	49650-09.....	462	51205-18.....	467
47471-05.....	441	47565-10.....	448	49287-04.....	455	49650-11.....	462	51205-23.....	467
47471-06.....	441	47566-12.....	448	49287-05.....	455	49660-18.....	463	51207-21.....	467
47471-07.....	441	47571-23.....	449	49288-02.....	455	49665-24.....	463	51209-20.....	467
47471-08.....	441	47572-23.....	449	49288-03.....	455	49670-19.....	463	51210-20.....	468
47471-10.....	441	47573-23.....	449	49288-04.....	455	49670-23.....	463	51211-21.....	468
47471-12.....	441	47575-23.....	449	49288-05.....	455	49671-01.....	463/1	51213-21.....	468
47472-10.....	441	47601-21.....	449	49310-00.....	455	49671-01CL.....	463/1	51219-22.....	468
47472-12.....	441	47607-01.....	449	49310-01.....	455	49671-02.....	463/1	51250-28.....	468
47472-14.....	441	47607-02.....	449	49310-02.....	455	49671-02CL.....	463/1	51252-28.....	468
47472-16.....	441	47607-03.....	449	49310-03.....	455	49673-01.....	463/2	51256-28.....	468
47473-01.....	442	47607-04.....	449	49310-04.....	455	49673-02.....	463/2	51257-40.....	468
47473-02.....	442	47607-05.....	449	49310-05.....	455	49673-03.....	463/2	51257-50.....	468
47473-03.....	442	47607-06.....	449	49310-10.....	455	49673-04.....	463/2	51259-03.....	468
47474-01.....	442	47620-00.....	450	49310-12.....	455	49675-18.....	463/3	51259-04.....	468
47474-02.....	442	47620-01.....	450	49315-00.....	456	49680-10.....	463/3	51259-05.....	468
47474-03.....	442	47620-02.....	450	49315-01.....	456	49680-20.....	463/3	51260-00.....	469
47481-05.....	442/1	47620-03.....	450	49315-02.....	456	49685-21.....	463/3	51270-00.....	470
47482-05.....	442/1	47620-04.....	450	49315-03.....	456	49691-15.....	463/3	51270-01.....	470
47484-04.....	442/1	47620-05.....	450	49315-10.....	456	49692-15.....	463/3	51270-02.....	470
47484-06.....	442/1	47620-06.....	450	49317-00.....	456	49694-25.....	463/4	51270-03.....	470
47484-08.....	442/1	47630-00.....	450	49317-01.....	456	49694-25CL.....	463/4	51270-04.....	470
47486-16.....	442/1	47630-01.....	450	49317-02.....	456	49695-01.....	463/5	51290-02.....	470
47487-16.....	442/1	47630-02.....	450	49317-03.....	456	49695-02.....	463/5	51290-05.....	470
47489-16.....	442/1	47630-03.....	450	49317-10.....	456	49696-18.....	463/6	51290-10.....	470
47502-16.....	443	47630-04.....	450	49320-00.....	457	49700-01.....	464	51290-20.....	470
47504-18.....	443	47636-01.....	450	49320-01.....	457	49700-02.....	464	51291-00.....	470
47507-17.....	443	47636-02.....	450	49320-02.....	457	49705-08.....	464/1	51292-00.....	470
47507-19.....	443	47636-03.....	450	49320-03.....	457	49705-12.....	464/1	51293-00.....	470
47511-21.....	443	47636-04.....	450	49320-10.....	457	49705-16.....	464/1	51293-45.....	470
47513-21.....	443	47641-01.....	450	49320-20.....	457	49705-20.....	464/1	51293-90.....	470
47514-16.....	443	47641-02.....	450	49340-00.....	457	49710-04.....	464/2	53101-22.....	471
47516-16.....	443	47641-03.....	450	49342-01.....	458	49710-06.....	464/2	53102-20.....	471
47518-21.....	444	47642-01.....	450	49342-02.....	458	49710-08.....	464/2	53103-22.....	471
47520-21.....	444	47642-02.....	450	49342-03.....	458	49711-04.....	464/2	53111-18.....	471
47521-01.....	444	47642-03.....	450	49342-04.....	458	49711-06.....	464/2	53115-01.....	471
47521-02.....	444	49102-16.....	451	49342-05.....	458	49713-06.....	464/2	53115-02.....	471
47521-03.....	444	49103-17.....	451	49345-01.....	458	49713-08.....	464/2	53115-03.....	471
47522-01.....	445	49104-15.....	451	49345-02.....	458	51103-18.....	465	53115-04.....	471
47522-04.....	445	49105-16.....	451	49345-03.....	458	51103-20.....	465	53121-24.....	471
47522-05.....	445	49106-01.....	451	49345-04.....	458	51103-22.....	465	53130-00.....	472
47522-07.....	445	49106-02.....	451	49345-05.....	458	51109-24.....	465	53131-20.....	472

53132-20.....	472	53272-18.....	473	57107-22.....	480	61008-19.....	493	61050-03.....	510
53132-30.....	472	53272-20.....	473	57111-21.....	480	61008-23.....	493	61050-04.....	510
53132-40.....	472	53272-22.....	473	57123-35.....	480	61009-16.....	494	61050-05.....	510
53132-50.....	472	53272-24.....	473	57125-35.....	480	61011-19.....	494	61050-07.....	510
53132-60.....	472	53272-26.....	473	57126-34.....	481	61011-20.....	494	61062-16.....	512
53150-00.....	472	53272-28.....	473	57131-26.....	481	61013-18.....	494	61063-16.....	512
53152-00.....	472	53272-30.....	473	57137-27.....	481	61013-19.....	494	61138-14.....	513
53154-00.....	472	53274-12.....	473	57138-21.....	481	61013-20.....	494	61138-16.....	513
53155-00.....	472	53276-10.....	473	57141-36.....	481	61014-15.....	495	61138-18.....	513
53157-00.....	472	53280-01.....	474	57146-28.....	481	61014-18.....	495	61138-20.....	513
53158-02.....	472	53280-02.....	474	57147-28.....	481	61015-15.....	495	61139-14.....	513
53158-03.....	472	53280-03.....	474	57210-16.....	482	61015-18.....	495	61139-16.....	513
53160-02.....	472	53280-04.....	474	57210-20.....	482	61016-20.....	495	61139-18.....	513
53160-03.....	472	53280-05.....	474	57210-25.....	482	61017-26.....	496	61139-20.....	513
53162-00.....	472	53280-06.....	474	57214-75.....	482	61017-27.....	496	61140-17.....	514
53164-01.....	472	53280-07.....	474	57230-13.....	482	61017-31.....	496	61141-16.....	514
53164-02.....	472	53280-08.....	474	57230-17.....	482	61017-33.....	496	61143-15.....	514
53166-00.....	472	53280-09.....	474	57230-18.....	482	61018-28.....	497	61145-15.....	514
53170-00.....	472	53280-10.....	474	57234-75.....	482	61019-30.....	498	61147-17.....	514
53175-00.....	472	53280-11.....	474	57236-20.....	483	61020-27.....	498	61149-17.....	515
53177-01.....	472	53290-01.....	475	57236-25.....	483	61021-24.....	499	61151-17.....	515
53177-02.....	472	53290-02.....	475	57236-30.....	483	61022-24.....	499	61153-16.....	515
53230-01.....	473	53290-03.....	475	57242-20.....	483	61023-25.....	500	61153-17.....	515
53230-02.....	473	53290-04.....	475	57242-25.....	483	61023-26.....	500	61156-16.....	515
53230-03.....	473	53290-05.....	475	57242-30.....	483	61024-01.....	501	61156-17.....	515
53230-04.....	473	53290-06.....	475	57244-13.....	483	61024-02.....	501	61156-18.....	515
53230-05.....	473	53290-07.....	475	57245-13.....	484	61025-20.....	502	61157-17.....	516
53230-06.....	473	53290-08.....	475	57246-16.....	484	61025-24.....	502	61158-10.....	516
53230-07.....	473	55111-13.....	476	57246-21.....	484	61025-25.....	502	61158-11.....	516
53230-08.....	473	55111-14.....	476	57247-95.....	485	61025-26.....	502	61158-12.....	517
53240-01.....	473	55113-14.....	476	57248-14.....	485	61025-27.....	502	61159-12.....	517
53240-02.....	473	55115-07.....	476	57249-01.....	485	61026-01.....	503	61159-13.....	517
53240-03.....	473	55116-15.....	476	57249-02.....	485	61026-02.....	503	61161-14.....	517
53240-04.....	473	55117-17.....	476	57251-15.....	486	61026-03.....	503	61161-18.....	517
53240-05.....	473	55118-16.....	477	57252-19.....	486	61026-04.....	503	61161-19.....	517
53240-06.....	473	55119-16.....	477	57260-02.....	487	61027-23.....	504	61172-15.....	518
53240-07.....	473	55120-15.....	477	57260-03.....	487	61027-25.....	504	61173-16.....	518
53240-08.....	473	55122-16.....	477	57260-04.....	487	61029-25.....	504	61174-17.....	518
53250-01.....	473	55124-16.....	477	57260-06.....	487	61030-21.....	505	61175-17.....	518
53250-02.....	473	55151-05.....	477	57260-09.....	487	61030-22.....	505	61176-17.....	518
53250-03.....	473	55151-07.....	477	57264-16.....	487	61031-17.....	505	61177-17.....	518
53250-04.....	473	55151-09.....	477	57266-13.....	488	61032-18.....	506	61178-16.....	519
53250-05.....	473	55200-00.....	478	57270-00.....	489	61032-20.....	506	61179-18.....	519
53250-06.....	473	55220-04.....	479	57270-65.....	489	61032-23.....	506	61180-17.....	519
53250-07.....	473	55220-05.....	479	57270-75.....	489	61032-25.....	506	61187-16.....	519
53250-08.....	473	55220-06.....	479	57270-80.....	489	61033-23.....	506	61187-17.....	519
53260-01.....	473	55220-07.....	479	57283-14.....	489	61033-24.....	506	61188-20.....	520
53260-02.....	473	55220-08.....	479	57284-16.....	489	61033-25.....	506	61189-21.....	520
53260-03.....	473	55220-09.....	479	57286-16.....	489	61034-21.....	507	61190-17.....	520
53260-04.....	473	55220-10.....	479	57288-30.....	489	61034-23.....	507	61191-16.....	520
53260-05.....	473	55220-11.....	479	57289-32.....	489	61034-27.....	507	61192-17.....	520
53260-06.....	473	55220-12.....	479	57290-20.....	490	61034-31.....	507	61259-15.....	521
53260-07.....	473	55220-13.....	479	57291-20.....	490	61035-21.....	507	61261-16.....	521
53260-08.....	473	55240-04.....	479	57301-30.....	490	61035-23.....	507	61263-16.....	521
53270-08.....	473	55240-05.....	479	57307-24.....	490	61035-27.....	507	61266-01.....	522
53270-10.....	473	55240-06.....	479	57309-22.....	490	61035-31.....	507	61266-02.....	522
53270-12.....	473	55240-07.....	479	57311-22.....	490	61036-18.....	508	61266-03.....	522
53270-14.....	473	55240-08.....	479	57313-22.....	490	61036-19.....	508	61266-04.....	522
53270-16.....	473	55240-09.....	479	57321-23.....	491	61036-23.....	508	61266-05.....	522
53270-18.....	473	55240-10.....	479	57323-23.....	491	61036-27.....	508	61372-01.....	523
53270-20.....	473	55240-11.....	479	57325-15.....	491	61037-20.....	508	61372-02.....	523
53270-22.....	473	55240-12.....	479	57327-26.....	491	61037-21.....	508	61372-03.....	523
53270-24.....	473	55240-13.....	479	57329-26.....	491	61037-25.....	508	61372-04.....	523
53270-26.....	473	55501-15.....	479	61000-21.....	492	61037-29.....	508	61372-05.....	523
53270-28.....	473	55503-15.....	479	61000-22.....	492	61038-12.....	509	61372-06.....	523
53270-30.....	473	55511-21.....	479	61001-21.....	492	61039-12.....	509	61372-07.....	523
53272-08.....	473	55520-15.....	479	61001-22.....	492	61040-21.....	510	61372-08.....	523
53272-10.....	473	55520-20.....	479	61003-21.....	492	61045-18.....	511	61372-09.....	523
53272-12.....	473	55523-17.....	479	61003-22.....	492	61046-19.....	511	61373-01.....	523
53272-14.....	473	57102-23.....	480	61005-22.....	493	61050-01.....	510	61373-02.....	523
53272-16.....	473	57105-22.....	480	61007-22.....	493	61050-02.....	510	61373-03.....	523

61373-04.....	523	61506-00.....	528	63173-06.....	533	65217-18.....	540	67147-27.....	552
61373-05.....	523	61700-01.....	528	63173-07.....	533	65217-21.....	540	67149-27.....	552
61373-06.....	523	61700-33.....	528	63173-08.....	533	65217-23.....	540	67150-00.....	552
61373-07.....	523	61710-01.....	528	63174-00.....	268	65220-13.....	540	67155-00.....	552
61373-08.....	523	61710-33.....	528	63175-27.....	534	65220-22.....	540	67160-00.....	552
61373-09.....	523	61810-05.....	529	63178-01.....	534	65220-25.....	540	67163-00.....	553
61374-01.....	523	61810-10.....	529	63178-03.....	534	65220-28.....	540	67165-00.....	553
61374-02.....	523	61810-15.....	529	63180-17.....	534	65221-13.....	540	67169-00.....	553
61374-03.....	523	61810-20.....	529	63180-21.....	534	65221-22.....	540	67169-01.....	553
61374-04.....	523	61810-25.....	529	63180-24.....	534	65221-25.....	540	67172-20.....	553/1
61374-05.....	523	61810-30.....	529	63180-27.....	534	65221-28.....	540	67172-28.....	553/1
61374-06.....	523	61810-35.....	529	63210-32.....	534	65226-22.....	540	67175-08.....	553/1
61374-07.....	523	61810-40.....	529	63231-01.....	535	65226-25.....	540	67177-11.....	553/1
61374-08.....	523	61810-45.....	529	63231-02.....	535	65226-28.....	540	67178-12.....	553/2
61374-09.....	523	61810-50.....	529	63231-03.....	535	65227-22.....	540	67178-14.....	553/2
61460-15.....	524	61810-70.....	529	63231-04.....	535	65227-25.....	540	67179-14.....	553/2
61460-19.....	524	61810-90.....	529	63231-05.....	535	65227-28.....	540	67184-39.....	554
61461-15.....	524	61820-05.....	529	63231-06.....	535	65230-21.....	541	67185-35.....	554
61461-19.....	524	61820-10.....	529	63232-01.....	536	65230-23.....	541	67201-08.....	554
61461-28.....	525	61820-15.....	529	63232-02.....	536	65230-25.....	541	67201-10.....	554
61462-19.....	524	61820-20.....	529	65102-12.....	537	65231-21.....	541	67201-12.....	554
61462-28.....	525	61820-25.....	529	65102-14.....	537	65231-23.....	541	67201-14.....	554
61463-19.....	524	61820-30.....	529	65108-15.....	537	65231-25.....	541	67201-16.....	554
61463-28.....	525	61820-35.....	529	65110-15.....	537	65236-25.....	541	67201-18.....	554
61464-15.....	524	61820-40.....	529	65120-15.....	537	65237-25.....	541	67201-20.....	554
61464-19.....	524	61820-45.....	529	65120-19.....	537	65238-33.....	541	67201-22.....	554
61464-28.....	525	61820-50.....	529	65120-22.....	537	65239-33.....	541	67201-24.....	554
61465-15.....	524	61820-70.....	529	65120-24.....	537	65241-23.....	542	67201-26.....	554
61465-19.....	524	61820-90.....	529	65124-16.....	537	65242-30.....	542	67201-28.....	554
61465-28.....	525	61910-01.....	530	65124-20.....	537	65255-19.....	543	67201-30.....	554
61466-15.....	524	61910-02.....	530	65124-22.....	537	65256-19.....	543	67201-32.....	554
61466-19.....	524	61910-03.....	530	65124-25.....	537	65259-24.....	543	67201-34.....	554
61466-28.....	525	61910-04.....	530	65124-30.....	537	65260-24.....	543	67201-36.....	554
61467-15.....	524	61920-14.....	530	65130-15.....	537	65261-15.....	544	67205-08.....	554
61467-19.....	524	61920-23.....	530	65132-16.....	538	65262-12.....	544	67205-10.....	554
61467-28.....	525	61930-18.....	530	65132-20.....	538	65263-15.....	544	67205-12.....	554
61468-19.....	524	61930-21.....	530	65140-15.....	538	65263-20.....	544	67205-14.....	554
61468-28.....	525	63101-23.....	531	65140-19.....	538	65265-26.....	545	67205-16.....	554
61469-19.....	524	63103-23.....	531	65145-15.....	538	65265-28.....	545	67205-18.....	554
61469-28.....	525	63106-20.....	531	65150-20.....	538	65270-15.....	545	67205-20.....	554
61470-15.....	524	63107-20.....	531	65154-18.....	538	65272-07.....	545	67205-22.....	554
61470-19.....	524	63110-20.....	531	65160-14.....	539	65272-10.....	545	67205-24.....	554
61471-15.....	524	63111-20.....	531	65160-16.....	539	65274-00.....	545	67205-26.....	554
61471-19.....	524	63117-22.....	531	65160-18.....	539	65280-05.....	546	67205-28.....	554
61471-28.....	525	63125-28.....	532	65160-20.....	539	65280-07.....	546	67205-30.....	554
61472-19.....	524	63130-13.....	532	65160-24.....	539	65280-10.....	546	67205-32.....	554
61472-28.....	525	63130-18.....	532	65164-16.....	539	65282-26.....	546	67205-34.....	554
61473-19.....	524	63130-21.....	532	65164-20.....	539	65284-08.....	546	67205-36.....	554
61473-28.....	525	63142-34.....	532	65168-16.....	539	65284-23.....	546	67205-38.....	554
61481-15.....	524	63150-00.....	532	65168-20.....	539	65290-30.....	547	67205-40.....	554
61481-19.....	524	63150-01.....	532	65170-18.....	539	65291-30.....	547	67206-08.....	554
61482-15.....	524	63150-02.....	532	65170-20.....	539	65310-15.....	548	67206-09.....	554
61482-19.....	524	63150-03.....	532	65172-20.....	539	65310-21.....	548	67206-10.....	554
61482-28.....	525	63150-04.....	532	65172-23.....	539	65310-29.....	548	67206-11.....	554
61483-19.....	524	63150-05.....	532	65174-20.....	539	65310-35.....	548	67206-12.....	554
61483-28.....	525	63150-06.....	532	65178-19.....	539	65320-00.....	549	67206-13.....	554
61484-19.....	524	63150-07.....	532	65178-23.....	539	67101-21.....	550	67206-14.....	554
61484-28.....	525	63150-08.....	532	65180-16.....	539	67103-22.....	550	67206-15.....	554
61488-16.....	526	63150-09.....	532	65210-18.....	540	67105-21.....	550	67206-16.....	554
61489-16.....	526	63150-10.....	532	65210-21.....	540	67105-22.....	550	67206-17.....	554
61490-15.....	526	63150-11.....	532	65210-23.....	540	67106-20.....	550	67206-18.....	554
61491-15.....	526	63150-12.....	532	65211-18.....	540	67110-23.....	550	67206-19.....	554
61492-16.....	526	63150-13.....	532	65211-21.....	540	67111-23.....	550	67206-20.....	554
61493-01.....	527	63170-21.....	533	65211-23.....	540	67122-23.....	551	67206-21.....	554
61493-02.....	527	63170-22.....	533	65216-13.....	540	67123-23.....	551	67206-22.....	554
61493-03.....	527	63170-23.....	533	65216-16.....	540	67125-24.....	551	67206-23.....	554
61495-01.....	527	63173-01.....	533	65216-18.....	540	67130-00.....	552	67206-24.....	554
61495-02.....	527	63173-02.....	533	65216-21.....	540	67130-01.....	552	67206-25.....	554
61495-03.....	527	63173-03.....	533	65216-23.....	540	67130-02.....	552	67206-26.....	554
61495-04.....	527	63173-04.....	533	65217-13.....	540	67130-03.....	552	67206-27.....	554
61500-00.....	528	63173-05.....	533	65217-16.....	540	67132-00.....	552	67206-28.....	554



67206-29.....554	69127-01.....560	69460-00.....568	71300-01.....574	71410-17.....578
67206-30.....554	69127-02.....560	71100-00.....569	71301-01.....574	71410-18.....578
67207-08.....554	69127-03.....560	71110-01.....570	71301-02.....574	71410-19.....578
67207-09.....554	69130-19.....560	71110-02.....570	71301-03.....574	71410-20.....578
67207-10.....554	69142-06.....560	71110-03.....570	71303-01.....574	71410-21.....578
67207-11.....554	69142-08.....560	71115-02.....569	71303-02.....574	71410-22.....578
67207-12.....554	69142-12.....560	71115-03.....569	71303-03.....574	71410-23.....578
67207-13.....554	69147-00.....561	71116-02.....570	71303-04.....574	71410-24.....578
67207-14.....554	69147-02.....561	71120-00.....570	71303-05.....574	71410-25.....578
67207-15.....554	69147-03.....561	71120-01.....570	71305-01.....574	71410-26.....578
67207-16.....554	69147-04.....561	71120-02.....570	71305-02.....574	71410-27.....578
67207-17.....554	69148-00.....561	71120-03.....570	71305-03.....574	71410-28.....578
67207-18.....554	69150-15.....561	71130-01.....570	71305-04.....574	71410-29.....578
67207-19.....554	69210-22.....562	71130-02.....570	71305-05.....574	71410-30.....578
67207-20.....554	69212-16.....562	71130-03.....570	71306-00.....575	71415-01.....578
67207-21.....554	69212-19.....562	71132-00.....570	71306-01.....575	71415-02.....578
67207-22.....554	69212-22.....562	71140-01.....570	71306-02.....575	71415-03.....578
67207-23.....554	69220-05.....562	71140-02.....570	71306-03.....575	71415-04.....578
67207-24.....554	69220-10.....562	71140-03.....570	71306-04.....575	71415-05.....578
67207-25.....554	69220-14.....562	71142-04.....570	71306-05.....575	71415-06.....578
67207-26.....554	69220-20.....562	71150-01.....571	71306-06.....575	71415-07.....578
67207-27.....554	69224-21.....563	71150-02.....571	71306-07.....575	71415-08.....578
67207-28.....554	69224-27.....563	71150-03.....571	71306-08.....575	71415-09.....578
67207-29.....554	69225-22.....563	71160-01.....571	71307-00.....576	71415-10.....578
67207-30.....554	69225-30.....563	71160-02.....571	71308-00.....576	71415-11.....578
67211-06.....555	69226-25.....564	71160-03.....571	71308-01.....576	71415-12.....578
67211-08.....555	69226-29.....564	71161-17.....571	71308-02.....576	71415-13.....578
67211-10.....555	69226-38.....564	71161-25.....571	71308-03.....576	71415-14.....578
67211-12.....555	69227-01.....565	71170-01.....571	71308-04.....576	71415-15.....578
67211-14.....555	69227-02.....565	71170-02.....571	71309-00.....576	71415-16.....578
67211-16.....555	69227-03.....565	71170-03.....571	71310-20.....577	71415-17.....578
67211-18.....555	69227-04.....565	71210-01.....572	71310-25.....577	71415-18.....578
67211-20.....555	69227-05.....565	71210-02.....572	71310-30.....577	71415-19.....578
67211-22.....555	69227-06.....565	71210-03.....572	71310-35.....577	71420-01.....579
67211-24.....555	69228-01.....565	71211-01.....572	71310-40.....577	71420-03.....579
67213-06.....555	69229-01.....565	71211-02.....572	71313-20.....577	71420-05.....579
67213-08.....555	69229-02.....565	71211-03.....572	71313-25.....577	71420-07.....579
67213-10.....555	69251-01.....563	71212-01.....572	71313-30.....577	71420-09.....579
67213-12.....555	69251-02.....563	71212-02.....572	71313-35.....577	71420-11.....579
67213-14.....555	69251-03.....563	71212-03.....572	71313-40.....577	71420-13.....579
67213-16.....555	69261-41.....566	71240-00.....572	71315-40.....577	71420-15.....579
67213-18.....555	69263-30.....566	71240-01.....572	71319-28.....577	71420-17.....579
67213-20.....555	69301-28.....566	71240-02.....572	71319-38.....577	71420-19.....579
67213-22.....555	69301-35.....566	71240-03.....572	71351-10.....577	71420-21.....579
67213-24.....555	69301-42.....566	71240-10.....572	71360-24.....577	71420-23.....579
67219-08.....555	69302-28.....566	71241-00.....572	71361-24.....577	71420-25.....579
67219-10.....555	69302-35.....566	71241-01.....572	71362-24.....577	71424-08.....579
67219-12.....555	69302-42.....566	71241-02.....572	71363-24.....577	71424-13.....579
67219-14.....555	69303-28.....566	71241-03.....572	71364-24.....577	71425-08.....579
67219-16.....555	69303-35.....566	71241-10.....572	71365-24.....577	71426-08.....579
67219-18.....555	69303-42.....566	71242-00.....572	71404-14.....578	71426-13.....579
67219-20.....555	69304-28.....566	71242-01.....572	71404-26.....578	71430-10.....580
67219-22.....555	69304-35.....566	71242-02.....572	71405-14.....578	71430-12.....580
67219-24.....555	69304-42.....566	71242-03.....572	71406-14.....578	71430-14.....580
67240-08.....556	69311-23.....567	71242-10.....572	71406-26.....578	71430-16.....580
67240-11.....556	69311-33.....567	71260-01.....573	71410-01.....578	71430-18.....580
67240-13.....556	69311-40.....567	71260-02.....573	71410-02.....578	71430-20.....580
67240-16.....556	69321-23.....567	71261-01.....573	71410-03.....578	71435-06.....580
67240-21.....556	69321-33.....567	71261-02.....573	71410-04.....578	71436-08.....580
67240-26.....556	69321-40.....567	71262-01.....573	71410-05.....578	71438-13.....580
67240-32.....556	69402-21.....567	71262-02.....573	71410-06.....578	71438-17.....580
67250-07.....556	69402-25.....567	71271-01.....573	71410-07.....578	71438-21.....580
67251-07.....556	69450-18.....568	71271-02.....573	71410-08.....578	71438-25.....580
69105-22.....559	69455-00.....568	71271-03.....573	71410-09.....578	71438-29.....580
69110-15.....559	69456-00.....568	71281-01.....573	71410-10.....578	71438-33.....580
69115-15.....559	69457-12.....568	71281-02.....573	71410-11.....578	71438-37.....580
69121-00.....559	69457-31.....568	71281-03.....573	71410-12.....578	71438-41.....580
69125-17.....559	69458-00.....568	71291-00.....573	71410-13.....578	71441-34.....581
69126-01.....560	69458-10.....568	71291-01.....573	71410-14.....578	71443-29.....581
69126-02.....560	69458-11.....568	71291-02.....573	71410-15.....578	71445-29.....581
69126-03.....560	69458-16.....568	71291-03.....573	71410-16.....578	71502-25.....582

71504-25.....582	71624-07.....591	71715-11.....597	71736-09.....599	73256-42.....607
71505-24.....582	71624-08.....591	71715-12.....597	71736-10.....599	73259-28.....607
71507-28.....582	71624-09.....591	71715-14.....597	71736-11.....599	73302-42.....607
71508-17.....582	71624-10.....591	71717-05.....597	71736-12.....599	73304-46.....607
71510-18.....582	71624-11.....591	71717-06.....597	71737-06.....599	73306-25.....607
71512-20.....583	71624-13.....591	71717-07.....597	71737-08.....599	73309-30.....607
71512-28.....583	71624-14.....591	71717-08.....597	71737-10.....599	75103-15.....608
71514-24.....583	71624-15.....591	71717-09.....597	71737-12.....599	75111-10.....608
71515-24.....583	71624-16.....591	71717-11.....597	71737-14.....599	75113-14.....608
71524-06.....583	71624-17.....591	71717-12.....597	71737-30.....597	75115-14.....608
71524-08.....583	71624-18.....591	71717-14.....597	71737-35.....597	75118-14.....608
71524-10.....583	71624-19.....591	71720-05.....597	71737-40.....597	75121-10.....608
71525-06.....583	71626-00.....592	71720-06.....597	71803-03.....600	75128-01.....608
71525-08.....583	71626-00-25.....592	71720-07.....597	71803-04.....600	75128-02.....608
71525-10.....583	71627-00.....592	71720-08.....597	71803-06.....600	75128-03.....608
71531-23.....583	71628-00.....592	71720-09.....597	71803-08.....600	75128-04.....608
71532-21.....583	71628-00-25.....592	71720-11.....597	71803-10.....600	75128-05.....608
71533-21.....583	71630-00.....590	71720-12.....597	71803-12.....600	75128-06.....608
71536-21.....584	71632-00.....593	71720-14.....597	71803-14.....600	75129-01.....608
71536-28.....584	71634-00.....593	71720-15.....597	71803-15.....600	75129-02.....608
71537-27.....584	71635-26.....593	71720-16.....597	71810-12.....601	75129-03.....608
71539-26.....584	71641-17.....594	71720-19.....597	71810-16.....601	75129-04.....608
71540-27.....585	71643-27.....594	71720-20.....597	71810-20.....601	75129-05.....608
71542-20.....585	71645-01.....594	71722-05.....597	71810-50.....601	75129-06.....608
71543-32.....585	71645-02.....594	71722-06.....597	73101-23.....602	75130-01.....608
71545-27.....585	71645-03.....594	71722-07.....597	73102-30.....602	75130-02.....608
71547-23.....585	71646-01.....594	71722-08.....597	73105-33.....602	75130-03.....608
71549-25.....585	71646-02.....594	71722-09.....597	73105-36.....602	75138-00.....608
71559-26.....586	71650-00.....596	71722-11.....597	73107-30.....602	75140-02.....608
71565-28.....586	71650-01.....596	71722-12.....597	73108-36.....602	75140-03.....608
71567-26.....586	71650-02.....596	71722-14.....597	73108-39.....602	75140-04.....608
71580-32.....586	71650-03.....596	71722-15.....597	73110-41.....602	75140-05.....608
71581-32.....586	71650-04.....596	71722-16.....597	73115-32.....602	75140-06.....608
71582-32.....586	71650-05.....596	71722-19.....597	73115-38.....602	75140-07.....608
71583-32.....586	71650-06.....596	71722-20.....597	73119-36.....602	75140-08.....608
71584-28.....586	71650-07.....596	71725-05.....597	73119-40.....602	75301-10.....609
71585-25.....586	71660-00.....596	71725-06.....597	73125-40.....603	75304-10.....609
71590-04.....587	71702-01.....594	71725-07.....597	73127-40.....603	75305-10.....609
71592-01.....587	71702-02.....594	71725-08.....597	73135-36.....603	75331-14.....609
71592-02.....587	71702-03.....594	71725-09.....597	73139-40.....603	75341-11.....609
71592-03.....587	71702-04.....594	71725-11.....597	73141-39.....603	75341-13.....609
71592-04.....587	71702-05.....594	71725-12.....597	73143-39.....603	75373-10.....610
71593-00.....587	71702-06.....594	71725-14.....597	73145-36.....603	75378-10.....610
71594-40.....587	71703-01.....595	71725-15.....597	73147-36.....603	75379-10.....610
71596-40.....587	71703-02.....595	71725-16.....597	73148-17.....603	75382-16.....610
71598-27.....587	71703-03.....595	71725-19.....597	73151-29.....604	75386-10.....610
71604-01.....588	71703-04.....595	71725-20.....597	73155-44.....604	75386-12.....610
71604-02.....588	71703-05.....595	71727-05.....597	73157-40.....604	75396-01.....611
71604-21.....588	71703-06.....595	71727-06.....597	73162-40.....604	75396-02.....611
71604-28.....588	71704-27.....595	71727-07.....597	73170-00.....604	75397-00.....611
71605-26.....588	71710-05.....597	71727-08.....597	73171-21.....604	75400-01.....612
71606-24.....588	71710-06.....597	71727-09.....597	73181-33.....605	75400-02.....612
71611-25.....588	71710-07.....597	71727-11.....597	73183-27.....605	75400-03.....612
71612-21.....588	71710-08.....597	71727-12.....597	73184-21.....605	75400-04.....612
71613-28.....589	71710-09.....597	71727-14.....597	73187-09.....605	75410-01.....612
71615-01.....589	71710-11.....597	71727-15.....597	73189-09.....605	75410-02.....612
71615-02.....589	71710-12.....597	71727-16.....597	73191-34.....605	75410-03.....612
71617-04.....589	71710-14.....597	71727-19.....597	73193-30.....605	75410-04.....612
71618-23.....589	71712-05.....597	71727-20.....597	73195-35.....605	75420-15.....612/1
71619-23.....589	71712-06.....597	71730-30.....597	73242-27.....606	75430-01.....612/1
71621-01.....590	71712-07.....597	71730-35.....597	73243-27.....606	75430-12.....612
71621-01-25.....590	71712-08.....597	71730-40.....597	73244-01.....606	75430-13.....612
71622-00.....590	71712-09.....597	71732-30.....597	73244-02.....606	75440-00.....612
71622-00-25.....590	71712-11.....597	71732-35.....597	73244-03.....606	75440-11.....612/1
71623-00.....590	71712-12.....597	71732-40.....597	73245-01.....606	75450-00.....612
71623-00-25.....590	71712-14.....597	71735-30.....597	73245-02.....606	75450-13.....612/2
71624-01.....591	71715-05.....597	71735-35.....597	73245-03.....606	75460-13.....612/2
71624-03.....591	71715-06.....597	71735-40.....597	73252-30.....606	75470-11.....612/2
71624-04.....591	71715-07.....597	71736-00.....599	73254-14.....606	75475-11.....612/2
71624-05.....591	71715-08.....597	71736-07.....599	73254-18.....606	75480-13.....612/2
71624-06.....591	71715-09.....597	71736-08.....599	73254-21.....606	75485-13.....612/2

75490-15.....	612/2	89140-02.....	620	89179-29.....	622	91011-55.....	629
75500-15.....	612/2	89140-05.....	620	89179-34.....	622	91011-56.....	629
75550-13.....	613	89140-10.....	620	89179-39.....	622	91011-61.....	629
75600-10.....	613	89140-20.....	620	89179-49.....	622	91011-62.....	629
75618-15.....	613	89141-10.....	620	89179-59.....	622	91020-01.....	629
75620-15.....	613	89142-01.....	620	R390.03.....	622	91020-02.....	629
75630-12.....	614	89142-02.....	620	R390.05.....	622	91020-03.....	629
75640-15.....	614	89142-03.....	620	R390.07.....	622	91020-04.....	629
89111-25.....	615	89142-04.....	620	R390.10.....	622	91022-05.....	629
89111-32.....	615	89142-05.....	620	R190.03.....	622	91022-10.....	629
89112-65.....	615	89142-06.....	620	R190.05.....	622	91022-20.....	629
89113-65.....	615	89142-07.....	620	R190.07.....	622	91024-10.....	629
89114-00.....	615	89145-23.....	620	R190.10.....	622	91024-15.....	629
89115-50.....	615	89145-30.....	620	R191.03.....	622	91024-20.....	629
89115-65.....	615	89145-31.....	620	R191.05.....	622	91030-02.....	629
89115-75.....	615	89145-35.....	620	R191.07.....	622	91030-04.....	629
89116-50.....	615	89146-20.....	268/621	R191.10.....	622	91030-06.....	629
89116-65.....	615	89147-10.....	621	89250-10.....	623	91102-11.....	630
89116-75.....	615	89147-21.....	620	89250-20.....	623	91104-11.....	630
89117-20.....	616	89147-24.....	620	89250-30.....	623	91109-11.....	630
89117-23.....	616	89147-25.....	621	89250-40.....	623	91113-11.....	630
89117-27.....	616	89147-30.....	620	89250-50.....	623	91115-11.....	630
89118-20.....	616	89147-31.....	620	89250-60.....	623	91122-16.....	630
89118-23.....	616	89147-35.....	620	89255-60.....	623	91123-16.....	630
89118-27.....	616	89147-40.....	620	89256-29.....	623	91124-16.....	630
89122-16.....	617	89147-42.....	620	89256-46.....	623	91125-16.....	630
89122-21.....	617	89148-25.....	621	89256-67.....	623	91127-16.....	630
89122-26.....	617	89148-31.....	621	89257-46.....	623	91142-16.....	631
89122-30.....	617	89148-32.....	621	89260-13.....	624	91144-16.....	631
89124-23.....	618	89148-35.....	621	89260-17.....	624	91146-16.....	631
89124-26.....	618	89148-50.....	621	89260-20.....	624	91152-19.....	631
89124-27.....	618	89149-13.....	621	89260-25.....	624	91154-19.....	631
89124-30.....	618	89149-20.....	621	89260-30.....	624	91157-19.....	631
89124-32.....	618	89150-30.....	621	89260-40.....	624	91159-19.....	631
89124-42.....	618	89152-08.....	622	89265-12.....	624	91162-19.....	632
89125-23.....	618	89152-10.....	622	89270-15.....	624	91164-19.....	632
89125-26.....	618	89152-12.....	622	89500-00.....	626	91166-19.....	632
89125-30.....	618	89155-08.....	622	89500-01.....	626	91167-19.....	632
89125-32.....	618	89155-10.....	622	89500-02.....	626	91169-19.....	632
89125-42.....	618	89155-13.....	622	89500-03.....	626	91172-03.....	632
89126-23.....	618	89155-15.....	622	89500-04.....	626	91172-07.....	632
89126-26.....	618	89155-19.....	622	89500-05.....	626	91172-12.....	632
89126-27.....	618	89159-14.....	622	89500-06.....	626	91190-30.....	633
89126-30.....	618	89159-16.....	622	89500-07.....	626	91190-50.....	633
89126-32.....	618	89159-19.....	622	89500-08.....	626	91191-30.....	633
89126-42.....	618	89159-24.....	622	89500-09.....	626	91192-30.....	633
89127-04.....	619	89164-14.....	622	89500-10.....	626	91192-50.....	633
89127-06.....	619	89164-16.....	622	89500-11.....	626	91193-30.....	633
89127-08.....	619	89164-19.....	622	89500-12.....	626	91193-50.....	633
89127-11.....	619	89164-24.....	622	89501-03.....	626	98000-01.....	634
89127-12.....	619	89164-29.....	622	91010-01.....	628	98000-02.....	634
89127-14.....	619	89164-34.....	622	91010-02.....	628		
89127-16.....	619	89164-39.....	622	91010-03.....	628		
89127-18.....	619	89169-14.....	622	91010-11.....	628		
89127-23.....	618	89169-16.....	622	91010-12.....	628		
89127-26.....	618	89169-19.....	622	91010-13.....	628		
89127-30.....	618	89169-24.....	622	91010-14.....	628		
89127-32.....	618	89169-29.....	622	91010-15.....	628		
89127-42.....	618	89169-34.....	622	91010-16.....	628		
89129-11.....	619	89169-39.....	622	91010-17.....	628		
89133-16.....	619	89174-14.....	622	91010-18.....	628		
89133-17.....	619	89174-16.....	622	91010-21.....	628		
89133-22.....	619	89174-19.....	622	91010-31.....	628		
89133-24.....	619	89174-24.....	622	91010-33.....	628		
89133-25.....	619	89174-29.....	622	91010-34.....	628		
89133-31.....	619	89174-34.....	622	91010-35.....	628		
89133-34.....	619	89174-39.....	622	91010-36.....	628		
89133-38.....	619	89179-14.....	622	91011-51.....	629		
89139-17.....	619	89179-16.....	622	91011-52.....	629		
89139-25.....	619	89179-19.....	622	91011-53.....	629		
89139-27.....	619	89179-24.....	622	91011-54.....	629		

Anlegezange, OLIVECRONA-TOENNIS .....	326	anatomische Pinzette, POTTS-SMITH .....	81	Arterienklemme, MAYO-GUYON .....	122
Abfalzange, SAUERBRUCH .....	227	anatomische Pinzette, SEMKEN .....	86	Arterienklemme, MEEKER .....	119
Abortuskürette, PESTALOZZA .....	606	anatomische Pinzette, TAYLOR .....	87	Arterienklemme, Micro-HARTMANN .....	104
Abortuslöffel, CUZZI .....	606	anatomische Pinzette, TC .....	81	Arterienklemme, MIXTER .....	119/1
Abortuslöffel, WALLICH .....	607	anatomische Pinzette, STILLE .....	81	Arterienklemme, MIXTER-BABY .....	119/1
Abortuszange, SAENGER .....	606	ANDERSON-ADSON, Wundspreizer .....	172	Arterienklemme, MOYNIHAN .....	120
Abortuszange, WINTER .....	606	ANDERSON, Wundhaken .....	198	Arterienklemme, O'SHAUGNESSY .....	119/2
ABRAHAM, Tonsillenfaßzange .....	468	ANDREW, Zungendrucker .....	452	Arterienklemme, OVERHOLT .....	114
ABRAHAM, Tonsillennmesser .....	466	ANDREW-PYNCHON, Saugrohr .....	28	Arterienklemme, PEAN .....	108, 110
Absaugküretten .....	600	Anesthophon .....	23	Arterienklemme, PENNINGTON .....	109
Absaugrohr, BUIE .....	566	Aneurysmaklemme, DeBAKEY-BAHNSON .....	506	Arterienklemme, PROVIDENCE-HOSPITAL .....	106
ADLERKREUTZ, Gefäßpinzette .....	84	Anlegepinzette, MEHDORN .....	362	Arterienklemme, ROBERTS .....	117
ADSON, anatomische Pinzette .....	81/2	Anlegezange .....	357 - 360	Arterienklemme, ROCHESTER-CARMALT .....	109
ADSON, Arterienklemme .....	112	Anlegezange, JOHNS-HOPKINS .....	104	Arterienklemme, ROCHESTER-OCHSNER .....	108
ADSON-BABY, Arterienklemme .....	113	Anlegezange, McKENZIE .....	326	Arterienklemme, ROCHESTER-PEAN .....	108
ADSON-BABY, Wundspreizer .....	173	Anlegezange, SMITHWICK .....	326	Arterienklemme, RUMEL .....	117
ADSON, chirurgische Pinzette .....	81/2	Anlegezange, SWEET .....	326	Arterienklemme, SAROT .....	118
ADSON, Durahaken .....	329	ANTRUM, Kürette .....	435	Arterienklemme, SPENCER-WELLS .....	109
ADSON, Halteklemme .....	298	Antrumkürette, COAKLEY .....	449	Arterienklemme, STILLE .....	122
ADSON, Hohlmeißelzange .....	236	Antrumraspel, WIENER .....	443	Arterienklemme, TOENNIS .....	117
ADSON, Hypophysepinzette .....	334	Antrumraspel, GALLAHER .....	446	Arterienklemme, WIKSTROEM .....	117
ADSON-Micro, anatomische Pinzette .....	81/2	Anuskop, HIRSCHMANN .....	562	Arterienklemme, ZENKER .....	118
ADSON-Micro, chirurgische Pinzette .....	82	Anuskop, IVES-FANSLER .....	562	Arterienklemme, OVERHOLT-BABY .....	114
ADSON, Nadelhalter .....	211	Anuskop, KELLY .....	562, 563	Arterienklemme, OVERHOLT-GEISSENDOERFER .....	114
ADSON, Raspator .....	282	ANVIL, Nagelspaltzange .....	613	Arterienklemme, OVERHOLT-MIXTER .....	115
ADSON, Saugrohr .....	337	Aorta-Aneurysmaklemme, DeBAKEY .....	496 - 498	ASCH, Septumrichtzange .....	449
ADSON, Wundspreizer .....	172 - 174	Aortadilatator, COOLEY .....	528	Atrauma-Arterienklemme, DeBAKEY-MOSQUITO .....	509
ADSON-BROWN, chirurgische Pinzette .....	82	Aortadilatator, TUBBS .....	528	Atrauma-Arterienklemme, DeBAKEY-PEAN .....	513
AEBLI, Ophthalmologie-Schere .....	58	Aortaklemme, DIETRICH .....	510	Atrauma-Arterienklemme, DeBAKEY-RANKIN .....	512
AESCULAP, Verbindungskabel .....	633	Aortaklemme, MORRIS-DeBAKEY .....	506	Atrauma-Bulldogklemme, DeBAKEY .....	103
Ahle, OBWEGESER .....	463, 463/3	Aortaklemme, DeBAKEY .....	499, 500	Atrauma-Bulldogklemme, GLOVER .....	103
AIR-INJECTION, Augenkantüle .....	394	Aortaklemme, WEBER .....	501	Atrauma-Darmfaßzange .....	539
ALAN-PARKS, Mastdarm-Spekula .....	561	Approximator, BIEMER .....	366	Atraumaklemmen .....	492 - 523, 526, 527
ALDERDYCE, Elevator .....	282	Approximator, BIEMER-MÜLLER .....	363	Atrauma-Neonatalklemme .....	523
ALEXANDER, Biopsiezange .....	589	Approximator, MÜLLER .....	364	Atrauma-Pinzette, DeBAKEY .....	98
ALEXANDER, Flachmeißel .....	259	ARCHER, Splitterzange .....	92	Atrauma-Pinzette, DeBAKEY TC .....	99
ALEXANDER, Hohlmeißel .....	259	ARLT, Starschlinge .....	378	Atrauma-Gefäßklemme, BECK .....	516
ALEXANDER, Raspator .....	276	Armsystem .....	188, 189	AUFRANC-COBRA, Knochenhebel .....	289
ALEXANDER, Uterus-Biopsiezange .....	589	ARRUGA, Extraktionshaken .....	375	AUFRANC-COBRA, Wundhaken .....	289
ALLEN, Blinddarmklemme .....	544	ARRUGA, Kapselpinzette .....	391	Aufreiber, KUENTSCHER .....	321
ALLIS, Darmfaßzange .....	537	ARRUGA, Lidsperrer .....	370	AUFRICHT, Nasenhaken .....	447
ALLIS-ADAIR, Darmfaßzange .....	537	ARRUGA, Nadelhalter .....	214	AUFRICHT, Nasenraspel .....	443
ALLIS-BABY, Darmfaßzange .....	537	ARRUGA, Wundlöffel .....	378	Aufsatz allein f. Uterus-Biopsiezangen .....	591
ALLISON, Lungenspatel .....	489	Arterienklemme, BIRKETT .....	116	Aufsatz f. Reinigungspistole .....	626
ALM, Wundhaken .....	168	Arterienklemme, MIXTER .....	116	Aufsatz, BARACANI .....	472
ALU, Stimmgabeln .....	403	Arterienklemme, ADSON .....	112	Aufsatz, BRUENINGS .....	472
ALVIS, Fremdkörperkürette .....	374	Arterienklemme, ADSON-BABY .....	113	Aufsatz, CORDES .....	472
Amnioskop .....	601	Arterienklemme, BAINBRIDGE .....	119/2	Aufsatz, FRAENKEL .....	472
Amniotom, BEACHAM .....	586	Arterienklemme, BENGOLEA .....	112	Aufsatz, KRAUSE .....	472
Amputationsmesser, CATLIN .....	44	Arterienklemme, CRAFOORD .....	118	Aufsatz, LANGE .....	472
Amputationsmesser, LANGENBECK .....	44	Arterienklemme, CRAFOORD-SELLORS .....	119	Aufsatz, SCHEINMANN .....	472
Amputationsmesser, LISTON .....	44	Arterienklemme, CRILE .....	107	Aufsatz, SCHUMACHER .....	472
Amputationsmesser, REDA .....	44	Arterienklemme, CRILE-RANKIN .....	107	Aufsatz, SEIFERT .....	472
Amputationssäge, BIER .....	296	Arterienklemme, DANDY .....	109	Aufsätze f. SLUDER-BALLENGER .....	470
Amputationssäge, CHARRIERE .....	296	Arterienklemme, DESJARDINS .....	121	Augenkantüle, AIR-INJECTION .....	394
Amputationssäge, SATTERLEE .....	296	Arterienklemme, FUCHSIG .....	113	Augenkantüle, JENSEN .....	394
Analspreizer, SMITH-BUIE .....	561	Arterienklemme, GEMINI .....	115	Augenkantüle, LACRIMAL .....	394
Anastomosenklemme, BECK .....	516, 520	Arterienklemme, GRAY .....	121	Augenkantüle, McINTYRE .....	394
Anastomosenklemme, COOLEY-DERRA .....	519	Arterienklemme, GUYON .....	122	Augenkantüle, SHEETS .....	394/2
Anastomosenklemme, DE MARTEL-WOLFSON .....	546	Arterienklemme, HALSTED-MOSQUITO .....	105	Augenkantülen .....	394
Anastomosenklemme, DeBAKEY .....	505	Arterienklemme, HARTMANN .....	104	Augenmagnet, REDA .....	395
Anastomosenklemme, LAMBERT-KAY .....	505	Arterienklemme, HEISS .....	112	Augenschere, BARRAQUER .....	75
Anastomosenklemme, DERRA .....	515	Arterienklemme, JACOBSON .....	105	Augenschere, NOYES .....	75
Anastomosenklemme, POTTS .....	493	Arterienklemme, JOHNS-HOPKINS .....	120	Augenschere, VANNAS .....	79
anatomische Pinzette, BROPHY .....	84	Arterienklemme, KANTROWITZ .....	119/1	Augenschere, WECKER .....	75
anatomische Pinzette .....	81	Arterienklemme, KELLY .....	106	Augenschere, WESTCOTT .....	75
anatomische Pinzette, ADSON .....	81/2	Arterienklemme, KELLY-RANKIN .....	106	Aurikelklemme, HARKEN .....	503
anatomische Pinzette, ADSON-Micro .....	81/2	Arterienklemme, KOCHER .....	108	Autopsiesäge .....	231/1
anatomische Pinzette, BONNEY .....	88	Arterienklemme, LAHEY .....	119/2	AUVARD, Scheidenspekula .....	576
anatomische Pinzette, CUSHING .....	83	Arterienklemme, LAWRENCE .....	119	AXENFELD, Chalazionskürette .....	377
anatomische Pinzette, GERALD .....	86, 87	Arterienklemme, LERICHE .....	111	AYER, Chalazionspinzette .....	393
anatomische Pinzette, McINDOE .....	85	Arterienklemme, LOVELACE .....	109		
anatomische Pinzette, USA .....	81	Arterienklemme, LOWER .....	120		

B			
BABCOCK, Darmaßzange.....	539	Bauchdeckenhalter, DE BAKEY.....	189/1
BABINSKI, Perkussionshammer.....	24	Bauchdeckenhalter, DOYEN.....	189/1
BABY-BURKE, Uterus-Biopsiezange.....	590	Bauchdeckenhalter, GELPI.....	189/1, 189/2
BABY-GOSSET, Bauchdeckenhalter.....	181	Bauchdeckenhalter, RIGBY.....	189/2
BABY-KÖCHER, Darmklemme.....	540	Bauchdeckenhalter, JACKSON-BURROWS.....	189/2
BABY-METZENBAUM, Supercutschere.....	71	Bauchspatel.....	143
BABY-OLSEN-HEGAR, Nadelhalter.....	212	Bauchspatel, KADER.....	143/1
BABY-WEBSTER, Nadelhalter.....	208	Bauchspatel, KÖRTE.....	143/1
BABY-YANKAUER, Saugrohr.....	27	Bauchspatel, KÜMMELE.....	143/2, 144
BABYPHON, Blutdruckmeßgerät.....	10	Bauchspatel, LERICHE.....	143/2
BABY-TISCHLER, Uterus-Biopsiezange.....	592	BAUINGARTNER, Nadelhalter.....	208
BACKHAUS, Tuchklemme.....	132	BEACHAM, Amniotom.....	586
BACKHAUS-CLIP, Tuchklemme.....	132	BECHERT, Linsenmanipulator.....	379
BAILLEY-BABY, Rippenkontraktor.....	489	BECK, Anastomosenklemme.....	516, 520
BAILLEY-GIBBON, Rippenkontraktor.....	489	Beckenzirkel, COLLIER.....	605
BAILEY, Rippenkontraktor.....	489	Beckenzirkel, COLLIN.....	605
BAINBRIDGE, Arterienklemme.....	119/2	Beckenzirkel, MARTIN.....	605
BAINBRIDGE, Mehrzweck-Gefäßklemme.....	495	BECKER, Cystotom.....	375
BAKES, Gallengangdilator.....	532	BECKMANN, Ringmesser.....	450
BALFOUR-BABY, Bauchdeckenhalter.....	182	BECKMANN, Wundspreizer.....	176
BALFOUR, Bauchdeckenhalter.....	182	BECKMANN-ADSON, Wundspreizer.....	175
BALFOUR, Haken.....	193	BECKMANN-EATON, Wundspreizer.....	176
BALFOUR, Valve f. Bauchdeckenhalter.....	183	BEEBEE, Kronenschere.....	68
BALFOUR-US, Bauchdeckenhalter.....	184	BEER, Cilienpinzette.....	395
BALL AND SOCKET, Tuchklemme.....	133	BEESON, Gipspreiszer.....	232
BALLENGER, Schwingmesser.....	436	Beinhautmesser.....	47
BALLENGER, Septumelelevator.....	439	Beleuchtungsstab f. MORGAN.....	565
BALLENGER, Tonsillenzange.....	467	BELLUCCI, Mikro-Ohrscherchen.....	413, 417
Bandsmaß.....	25	BENDER, Einschläger.....	322
Bandscheibenstanze, FERRIS-SMITH-KERRISON.....	344, 344/2	BENGOLEA, Arterienklemme.....	112
Bandscheibenstanze, COLCLOUGH.....	344/1	BENNETT, Knochenhebel.....	283
BANE-HARTMANN, Hohlmeißelzange.....	237	BENSAUDE, Proktoskop.....	565
BANGERTER, Zykliodialspsatel.....	379	BENSON, Pyloruspreiszer.....	544
BARACANI, Aufsatz.....	472	BERENS, Disziionsmesser.....	372
BARANY, Lärmtrommel.....	405	BERGMANN, Hammer.....	272
BARBARA, Hähchen.....	419	BERGMANN, Verbandschere.....	69/1
BARBARA, Nadel.....	419	BERKE, Muskelpinzette.....	389
BARKAN, Goniotomiemesser.....	373	BERLINER, Perkussionshammer.....	24
BARNHILL, Ringmeser.....	450	BERNHARD, Tuchklemme.....	133
BARON, Saugrohr.....	336	BERRY, Drahtzange.....	319
BARR, Mastdarmspekula.....	559	Beschaidungsgerät, MOGEN.....	556
BARRAQUER, Augenschere.....	75	BETHUNE, Rippenschere.....	481
BARRAQUER, Cilienpinzette.....	395	Biegehebel, LANE.....	325
BARRAQUER, Fixationspinzette.....	390	BIEMER, Approximator.....	366
BARRAQUER, Irispinzette.....	384	BIEMER, Gefäßclip.....	361
BARRAQUER Keratoplastik-Messer.....	373	BIEMER-MÜLLER, Approximator.....	363
BARRAQUER, Lidsperrerr.....	370	BIER, Amputationssäge.....	296
BARRAQUER, Nadelhalter.....	216, 217	BILL, Zughebel.....	604
BARRAQUER-KATZIN, Irispinzette.....	384	BILLEAU, Ohrschlinge.....	409
BARRAQUER-TROUTMAN, Nadelhalter.....	216	Biopsie- und Absaugkürette.....	600
BARRET, Hakenzange.....	582	Biopsiekaniüle, MENGHINI.....	206
BARTON, Geburtszange.....	603	Biopsiekürette, HEANY.....	587
BARTON, Zughebel.....	603	Biopsiekürette, KEVORKIAN.....	587
Batteriegriff f. Kaltlicht.....	33	Biopsiekürette, MOD. MÜNCHEN.....	587
Batteriegriff f. Warmlicht.....	32	Biopsiekürette, NOVAK.....	587
Bauch- u. Darmspatel, KÜMMELE.....	143/2	Biopsiekürette, RANDALL.....	587
Bauchdeckenhalter, BABY-GOSSET.....	181	Biopsieküretten.....	600
Bauchdeckenhalter, BALFOUR.....	182	Biopsienadel, FRANKLIN-SILVERMANN.....	206
Bauchdeckenhalter, BALFOUR-BABY.....	182	Biopsiezange, KEVORKIAN-PACIFIC.....	592
Bauchdeckenhalter, BALFOUR-US.....	184	Biopsiezange, TISCHLER-KEVORKIAN.....	592
Bauchdeckenhalter, CHARNELY.....	289	Biopsiezange, TISCHLER-MORGAN.....	590
Bauchdeckenhalter, COLLIN.....	190	Biopsiezange, ALEXANDER.....	589
Bauchdeckenhalter, COLLIN-LOKTITE.....	191	Biopsiezange, BABY-TISCHLER.....	592
Bauchdeckenhalter, DENIS-BROWNE.....	185	Biopsiezange, BURKE.....	590
Bauchdeckenhalter, FRAZIER.....	181	Biopsiezange, BURKE-BABY.....	590
Bauchdeckenhalter, GOSSET.....	181	Biopsiezange, EPPENDORFER.....	590
Bauchdeckenhalter, KIRSCHNER.....	185, 187, 187/1	Biopsiezange, FAURE.....	588
Bauchdeckenhalter O'SULLIVAN-O'CONNOR.....	181	Biopsiezange, KEVORKIAN.....	589, 591
Bauchdeckenhalter, RICARD.....	191	Biopsiezange, MAXI GRASPER.....	593
Bauchdeckenhalter, ROCHARD.....	186	Biopsiezange, MINI-TOWNSEND-DOWN.....	591
Bauchdeckenhalter, COLLIN.....	190	Biopsiezange, MINI-TOWNSEND-UP.....	591
		Biopsiezange, SCHUBERT.....	588
		Biopsiezange, SCHUMACHER.....	588, 589
		Biopsiezange, THOMAS-GAYLOR.....	588
		Biopsiezange, TISCHLER-DOWN.....	591
		Biopsiezange, TISCHLER-MORGAN.....	591
		Biopsiezange, TISCHLER-UP.....	591
		Biopsiezange, TOWNSEND.....	591
		Biopsiezange, VAN DOREN.....	588
		Biopsiezange, WITTNER.....	589
		Bipolare Koagulation.....	630-633
		Bipolarkabel.....	633
		Bipolarpinzette.....	630-632
		BIRCHER-GANSKE, Knochenhaltezange.....	246
		BIRKETT, Arterienklemme.....	116
		BISHOP-HARMAN, Irispinzette.....	386
		BISHOP-HARMON, Spül- und Saugkanüle.....	394/1
		BLAKE, Gallensteinzange.....	531
		BLAKE, Uteruskürette.....	595
		Blasenhalssperrerr, MILLIN.....	553
		Blasenspatel, KÖCHER.....	552
		Blasenspatel, LEGUEU.....	552
		Blasenwundspreizer, LEGUEU.....	553
		Blasenwundspreizer, MILLIN.....	552
		Blasenwundspreizer, THOMSON-WALKER.....	552
		Blasenwundspreizer, JUDD-MASSON.....	552
		Blattosteotom, OBWEGESER.....	464/1
		Bleihand.....	250
		Blinddarmklemme, ALLEN.....	544
		Blinddarmklemme, KLEINSCHMIDT.....	544
		BLOHMKE, Tonsillenzange.....	467
		BLOUNT, Knochenhebel.....	288
		BLOUNT, Meniskushaken.....	289
		BLUMENTHAL, Hohlmeißelzange.....	236
		Blutdruckmessgerät, BABYPHON.....	10
		Blutdruckmessgerät, DIPLOMAT.....	5
		Blutdruckmessgerät, EXACTA.....	8
		Blutdruckmessgerät, PRECISA.....	9
		Blutschöpfpöfifel.....	268
		Blutstillungsmeißel, PASSOW.....	260
		BODENHAMMER, Mastdarmspekula.....	559
		BOEHLER, Extensionsbügel.....	312
		BOERMA, Geburtszange.....	604
		BOETTCHER, Tonsillenschere.....	59
		BÖHLER, Hohlmeißelzange.....	238
		BÖHLER, Knochensplitterzange.....	241
		Bohrapparat, STILLE-SHERMAN.....	298
		Bohrdraht, KIRSCHNER.....	306, 307
		Bohrdrahtspender.....	305, 310
		Bohrdrahtstütze.....	299
		Bohrer, Mc KENZIE.....	299, 302
		Bohrer, CRUTCHFIELD.....	327
		Bohrer, ERRICO.....	299
		Bohrer, Mc KENZIE.....	299
		BOIES, Elevator.....	277
		Bozenschneider.....	320
		BONACCOLTO, Strabismuspinzette.....	385
		BONN, Irispinzette.....	387
		BONNEY, anatomische Pinzette.....	88
		BONNEY, chirurgische Pinzette.....	88
		BOSE, Trachealhaken.....	477
		BOSE, Trachealspreizer.....	476
		BOUCHERON, Ohrspekula.....	399
		BOWMAN, Disziionsmesser.....	372
		BOWMAN, Disziionsnadel.....	374
		BOWMAN, Lidsperrerr.....	370
		BOWMAN, Tränenkanalsonde.....	381
		Box, PETRI.....	620
		BOYNTON, Nadelhalter.....	214
		BOYS-ALLIS, Darmaßzange.....	538
		BOZEMANN, Nadelhalter.....	211
		BOZEMANN, Tamponzange.....	138
		BOZEMANN-DOUGLAS, Tamponzange.....	138
		BRAND, Sehnenfaßinstrument.....	293
		BRAND, Sehenschäler.....	294
		BRAUN, Dekapitationshaken.....	607

BRAUN, Hakenzange .....	582	CASPAR, Stössel.....	258	Circumcionsgerät .....	556
BRAUN, Kranioklast .....	607	CASPAR, Wundspreizer .....	179	CITELLI, Knochenstanze .....	430
BRAUN, Uterusdepressor .....	586	CATANEDA, Neonatal-Gefäßklemme .....	527	CLAR, Stirnlampe .....	22
BRAUN-STADLER, Episiotomie-Schere .....	64	CASTROVIEJO, Diszisionsmesser .....	372	CLARK, Lidsperrerr .....	370
BREAST, Wundhaken .....	198	CASTROVIEJO, Fixierpinzette .....	390	CLAUS, Tonsillennadel .....	466
BREISKY, Scheidenspekula .....	577	CASTROVIEJO, Hornhautschere .....	79	CLAUS-EICKEN, Tonsillennadel .....	466
Breiten-Messinstrument .....	594	CASTROVIEJO, Kapselpinzette .....	391	CLAYMAN, Hähchen .....	376
BRISTOW, Knochenhebel .....	290	CASTROVIEJO, Klingenbrecher .....	45	CLEVELAND, Hohlmeißelzange .....	235
BRODIE, Hohlsonde .....	199	CASTROVIEJO, Lidsperrerr .....	371	Clipanlegezange, ETHICON .....	524, 525
Bronchoskopiezange, CHEVALIER-JACKSON .....	473	CASTROVIEJO, Meßzirkel.....	380	Clipanlegezange, HORIZON .....	524, 525
Bronchusklemme .....	126	CASTROVIEJO, Nadelhalter.....	215, 216	Clipanlegezange, PILLING .....	524, 525
Bronchusklemme, FINOCCHIETTO .....	490	CASTROVIEJO, Nahtpinzette.....	392	Clipanlegezange, SLS Clips .....	524, 525
Bronchusklemme, HARRINGTON .....	490	CASTROVIEJO, Tränenkanal dilator .....	381	CLOWARD, Laminektomiezange .....	342
Bronchusklemme, LEES.....	504	CASTROVIEJO, Zyklo dialysespatel .....	379	CLOWARD, Wirbelkörper spreizer .....	339
Bronchusklemme, PRICE-THOMAS .....	490	CASTROVIEJO-Micro, Nadelhalter .....	215	CLOWARD, Wundsperrerr .....	178
Bronchusklemme, SEMB .....	491	CASTROVIEJO-STANDARD, Nadelhalter .....	216	COAKLEY, Antrumkürette.....	449
BROPHY, anatomische Pinzette .....	84	CATLIN, Amputationsmesser .....	44	COAKLEY, Kieferhöhentroker .....	204
BROPHY, chirurgische Pinzette .....	84	Cauter, WADSWORTH-TODD .....	378	Coarctationsklemme, DeBAKEY .....	507
BROWN, Gewebepinzette.....	83	CAWOOD-MINNESOTA, Wangenhalter .....	451	Coarctationsklemme, POTTS .....	492
BROWN, Nadelhalter.....	209	Chalazionskürette, AXENFELD.....	377	COBB, Hohlmeißel .....	262
BRUENINGS, Aufsatz .....	472	Chalazionskürette, HEBRA .....	377	COBB, Kürette.....	252
BRUENINGS, Ohrspekula .....	401	Chalazionskürette, MEYHOEFER .....	377	COBB, Raspator .....	280
BRUENINGS, Septumzange .....	425	Chalazionspinzette, AYER.....	393	COBB, scharfer Löffel .....	252
BRUENINGS, Tonsillennmesser .....	466	Chalazionspinzette, DESMARRES .....	393	COLCLOUGH, Bandscheibenstanze .....	344/1
BRUENINGS, Tonsillenschürer.....	468	Chalazionspinzette, LAMBERT .....	393	COLLER-ORILE, Arterienklemme .....	106
BRUENINGS, Verlängerungsrohr .....	472	CHANDLER, Elevator .....	282	COLLIER, Beckenzirkel .....	605
BRUENINGS, Zungenspatel .....	451	CHAPUT, Gewebefaßzange .....	110	COLLIER, Nadelhalter .....	208
BRUNETTI, Meißel.....	268	CHARNLEY, Bauchdeckenhalter .....	289	COLLIN, Bauchdeckenhalter.....	190
BRÜNING-LUCAS, Flachmeißel .....	260	CHARRIERE, Amputationssäge .....	296	COLLIN, Beckenzirkel .....	605
BRUNNER, Darmklemme .....	543	CHEATLE, Sterilisierzange .....	227	COLLIN, Darmfaßzange .....	539
BRUNNER, Führungshohlsonde .....	221	HELSEA-EATON, Proktoskop .....	563	COLLIN, Dynamometer .....	25
BRUNNER, Rippenschere .....	481	CHERON, Tupferzange.....	137	COLLIN, Gewebefaßzange .....	110
BRUNNER, Wundhaken .....	167	CHERRY, Laminektomiesperrerr .....	488	COLLIN, Hammer.....	270
BRUNS, scharfer Löffel .....	251	CHEVALIER-JACKSON, Bronchoskopiezange .....	473	COLLIN-LOKTITE, Bauchdeckenhalter .....	191
BRUNS, Verbandschere .....	70	CHEVALIER-JACKSON, Trachealkanüle .....	479	COLLIN, Nabelschnurklemme .....	605
Bruststütze, KLEINSASSER .....	36	CHILDE, Wundklammerzange .....	224	COLLIN, Scheidenspekula .....	570
Bruststütze, NEGUS.....	459	chirurgische Nadel, KEITH .....	223	COLLIN, Sonde .....	586
BRYANT, Tupferzange .....	137	chirurgische Nadel, KOENIG .....	223	COLLIN, Tupferzange .....	137
BUCHWALD, Zungenspatel .....	451	chirurgische Nadeln .....	222	COLLIN, Uterus-Faßzange .....	585
BUCK, Fremdkörperhebel .....	412	chirurgische Pinzette.....	81/1	COLLIN, Uterus-Sonde .....	586
BUCK, Ohrkürette .....	407	chirurgische Pinzette, GERALD .....	87	COLLIN, Wundhaken.....	139
BUCK, Perkussionshammer .....	24	chirurgische Pinzette, POTTS-SMITH .....	81	COLLIN, Wundklammerzange .....	224
BUCK-GRAMCKO, Knochenhebel .....	285	chirurgische Pinzette, WAUGH .....	83	COLLIN, Zungenzange .....	453
BUIE, Rektal-Absaugrohr .....	566	chirurgische Pinzette, ADSON .....	81/2, 82	COLLIN-DUVAL, Faßpinzette .....	85
Bulldogklemme, ATRAUMA .....	100	chirurgische Pinzette, ADSON-Micro .....	82	COLLIN-HARTMANN, Wundhaken .....	141
Bulldogklemme, DeBAKEY .....	103	chirurgische Pinzette, ADSON-BROWN .....	82	Columella-Pinzette, COTTLE .....	448
Bulldogklemme, GLOVER .....	103	chirurgische Pinzette, BONNEY .....	88	COLVER, Tonsillenfaßzange .....	467
Bulldogklemme, JOHNS-HOPKINS .....	104	chirurgische Pinzette, BROPHY .....	84	CONE, Schädelstanze .....	331
BÜLOW-GUNAR-HEY, Schlauchklemme.....	130	chirurgische Pinzette, CUSHING .....	83	CONNIN-AMSLER, Markierungsinstrument .....	380
BUMM, Uteruskürette .....	597, 598	chirurgische Pinzette, FERRIS-SMITH .....	85	CONVERSE, Nasenhaken .....	448
BUNELL, Handbohrapparat .....	299	chirurgische Pinzette, GILLIES .....	86	CONVERSE, Nasenmesser .....	435
BUNELL, Sehnenführer .....	294	chirurgische Pinzette, LANE .....	84	COOLEY, Aortadilatator .....	528
BUNELL, Sehenschäler .....	292	chirurgische Pinzette, USA .....	81/1	COOLEY, Katheterklemme .....	510
BUNGE, Exenterationslöffel .....	378	chirurgische Pinzette TC, OEHLER .....	81/1	COOLEY, Kinder-Gefäßklemmen .....	522
BUNT, Sterilisierklammer .....	227, 624	chirurgische Pinzette, SEMKEN .....	86	COOLEY, Mehrzweck-Gefäßklemme .....	520
BURCH, Fixiergabel .....	373	chirurgische Pinzette, STILLE .....	81/1	COOLEY, Rippensperrerr .....	485, 487
BURKE, Uterus-Biopsiezange .....	590	chirurgische Pinzette, TAYLOR .....	87	COOLEY, Wundhaken .....	148
Bürstenspender .....	611	chirurgische Schere, IRIS .....	54	COOLEY-DERRA, Anastomosenklemme .....	519
BUSCH, Schere .....	64	chirurgische Schere, JOSEPH .....	54	COOLEY-NEONATAL, Rippensperrerr .....	485
BUSHE, scharfer Löffel .....	256	chirurgische Schere, KILNER .....	54	COOLY, Saugrohr .....	28
C .....		chirurgische Schere, REYNOLDS .....	54	COOPER, Unterbindungsnadel .....	219
CANFIELD, Tonsillennmesser .....	466	chirurgische Schere, SANVENERO .....	54	CORDES, Aufsatz .....	472
CAPLAN, Nasenzange .....	428	chirurgische Schere, STANDARD .....	51	CORONAL-BROW, Wundhaken .....	198
Cardiovascular-Klemme .....	526	chirurgische Schere, FERGUSSON .....	66	CORWIN-HEGAR, Drahtzange .....	319
CARMALT, Splitterpinzette .....	91	chirurgische Schere, METZENBAUM S .....	54	CORYLLOS, Rippenschere .....	480
CAROLL, Sehnenfaßinstrument .....	293	chirurgische Schere, SYSTRUNK .....	66	CORYLLOS, Wundhaken .....	166
Carotis-Shuntklemme, JAVID .....	511	Cilienpinzette, BARRAQUER .....	395	COS, Mikro-Ohrzängchen .....	414
CARPENTER, Tonsillenelevator .....	465	Cilienpinzette, BEER .....	395	COTTLE, Columella-Pinzette.....	448
CARPENTER, Tonsillennmesser .....	465	Cilienpinzette, DOUGLAS .....	395	COTTLE, Bulldogschere .....	56
Cartilageschere, MARTIN .....	65/1	Cilienpinzette, GRADLE .....	395	COTTLE, Fixierpinzette .....	410
CASPAR, Laminektomiespreizer .....	179, 180	Cilienpinzette, LITTAUER .....	395	COTTLE, Hammer .....	273
CASPAR, Spreizer .....	197	Cilienpinzette, REDA .....	395	COTTLE, Hauthäkchen .....	447/1, 448
		CINELLI, Septummeißel .....	441	COTTLE, Knorpelquetscher .....	440

COTTLE, Nasenhaken.....	447, 447/1	Darmquetschklemme, PAYR-BABY.....	548	DESJARDINS, Gallensteinlöffel.....	534
COTTLE, Nasenmesser.....	435	Darmschere.....	66	DESJARDINS, Gallensteinsonde.....	532
COTTLE, Nasenschere.....	59	Darmspatel.....	143	DESJARDINS, Gallensteinzange.....	531
COTTLE, Nasenspekula.....	423	Darmspatel, HABERER.....	143/1	DESMARRES, Chalazionspinzette.....	393
COTTLE, Osteotom.....	440	Darmspatel, KADER.....	143/1	DESMARRES, Wundhaken.....	151
COTTLE, Schere.....	56	Darmspatel, KÖRTE.....	143/1	DEUTSCHMANN, Starmesser.....	371
COTTLE, Septumelevator.....	439	Darmspatel, KÜMMEL.....	143/2	DeVILBISS, Schädelzange.....	332
COTTLE, Septummeißel.....	440	Darmspatel, LERICHE.....	143/2	Diagnostik-Besteck ECO "C".....	16
COTTLE-JOSEPH, Septumelevator.....	439	Darmspatel, REVERDIN.....	143/1	Diagnostik-Besteck ECO "T".....	16
COTTLE-KAZANJIAN, Knochensplitterzange.....	241	Darmspatel, RIBBON.....	143	Diagnostik-Besteck, RI-MINI.....	17
COTTLE-NEIVERT, Hauthäkchen.....	448	DARTIGUES, Uterusfaßzange.....	585	Diagnostik-Besteck, UNI III.....	15
COXETER, Metallkatheter.....	555	DASTOOR, Strabismuspinzette.....	386	DIEFFENBACH, Gefäßklemme.....	104
CRAFOOD-SELLORS, Arterienklemme.....	119	DAUBENSPECK, scharfer Löffel.....	255	DIETER, Mikro-Ohrzangchen.....	414
CRAFOORD, Arterienklemme.....	118	DAVIDSON (SCAPULA), Wundhaken.....	166	DIETRICH, Aortaklemme.....	510
CRAFOORD, Lungenschere.....	65/2	DAVIEL, Starlöffel.....	377	DIETRICH, Gefäßschere.....	60
CREGO, Elevator.....	282	DAVIS, Duradisektor.....	332	DIETRICH, Mini-Bulldogklemme.....	101
CRILE, Arterienklemme.....	107	DAVIS, Fremdkörpernadel.....	374	Dilatationsbougie, DITTEL.....	554
CRILE, Nadelhalter.....	213	DAVIS, Sterilisierpinzette.....	227	Dilatationsbougie, GUYON.....	554
CRILE, Nervhaken.....	328	DAVIS-BOYLE, Mundsperrer.....	455	Dilatationsbougie, VAN BUREN.....	554
CRILE, Wundhaken.....	140	DAVIS-BOYLE, Sperrer.....	455	Dilatator, HANK.....	580
CRILE-MURRAY, Nadelhalter.....	209	DAVIS-BOYLE, Zugendrücker.....	455	Dilatator, HEGAR.....	578, 579
CRILE-RANKIN, Arterienklemme.....	107	DAVIS-MEYER, Mundsperrer.....	457	Dilatator, PRAAT.....	580
CRILE-WOOD, Nadelhalter.....	209	DAY, Häkchen.....	409	DINGMANN, Elevator.....	463/3
CRITCHETT, Lidsperrer.....	370	DeBAKEY, Aorta-Aneurysmaklemme.....	496 - 498	DINGMANN, Knochenhalte zange.....	246
CRUTCHFIELD, Bohrer.....	327	DeBAKEY, Aortaklemme.....	499, 500	DINGMANN, Mundsperrer.....	456
CRUTCHFIELD, Schädelhalter.....	327	DeBAKEY, Bauchdeckenhalter.....	189/1	DINGMANN, Raspator.....	463, 463/3
CULLER, Irisspatel.....	378	DeBAKEY, Gefäßdilator.....	529	DINGMANN, Sperrer.....	456
CUSCO, Scheidenspekula.....	570, 571	DeBAKEY, Gefäßklemme.....	494 - 496	DIPLOMAT, Blutdruckmeßgerät.....	5
Cushing (TAYLOR), Pinzette TC.....	87	DeBAKEY, Ligaturklemme.....	499, 500	Dissektor, FISCH.....	420
CUSHING, anatomische Pinzette.....	83	DeBAKEY, Mehrzweck-Gefäßklemme.....	495, 508, 514 - 517	Dissektor, GORNEY.....	277
CUSHING, chirurgische Pinzette.....	83	DeBAKEY, Nadelhalter.....	210	Dissektor, PENFIELD.....	333
CUSHING, Bohrer.....	299	DeBAKEY, Saugrohr.....	28	Disziionsmesser, BOWMAN.....	372
CUSHING, Hirmspatel.....	336, 369	DeBAKEY, Tangentialklemme.....	502	Disziionsmesser, BERENS.....	372
CUSHING, Laminektomie zange.....	340	DeBAKEY-SATINSKY, Tangentialklemme.....	502	Disziionsmesser, CASTROVIEJO.....	372
CUSHING, Nervenhaken.....	328	DE BOER, Rippensperrer.....	486	Disziionsmesser, GRAEFKE.....	372
CUSHING, Pinzette.....	87	DE LEE, Geburtszange.....	602	Disziionsmesser, WHEELER.....	373
CUSHING, Wundhaken.....	151, 152	DE MARTEL, Führungsinstrument.....	330	Disziionsmesser, ZIEGLER.....	373
CUZZI, Abortuslöffel.....	606	DE MARTEL-WOLFSON, Anastomosenklemme.....	546	Disziionsnadel.....	374
Cystotom, BECKER.....	375	DE MARTEL-WOLFSON, Darmklemme.....	546	Disziionsnadel, BOWMAN.....	374
Cystotom, GRAEFKE.....	375	DE MARTEL-WOLFSON, Klemmenhalterung.....	546	DITTEL, Dilatationsbougie.....	554
CZERNY, Hakenzange.....	584	DE MARTEL-WOLFSON, Klemmenschießzange.....	546	DIX, Fremdkörperfächmeißel.....	374
CZERNY, Mastdarm-Spekula.....	559	DEAN, Iri smesser.....	372	DIX, Fremdkörperinstrument.....	380
D.....		DEAN, Tonsillenschere.....	59	Doppelkürlette.....	612
DANDY, Arterienklemme.....	109	DEAVER, Präparierschere.....	52	Doppellöffel, VOLKMANN.....	257
DANDY, Nervenhaken.....	328	DEAVER, Wundhaken.....	145, 146	DOUGHTY, Zungenspatel.....	458
DARLING, Wundspreizer.....	178	DEAVER-GRIP, Wundhaken.....	146	DOUGLAS, Cilienpinzette.....	395
Darmfaßzange, DOYEN-BABY.....	540	DeBAKEY, Anastomosenklemme.....	505	DOUGLAS, Kieferhöhlentrokar.....	204
Darmfaßzange, LOCKWOOD-ALLIS.....	538	DeBAKEY, Atrauma-Bulldogklemme.....	103	DOUGLAS, Tonsillensmesser.....	466
Darmfaßzange, ALLIS.....	537	DeBAKEY, Atrauma-Pinzette.....	98	DOYEN, Bauchdeckenhalter.....	189/1
Darmfaßzange, ALLIS-ADAIR.....	537	DeBAKEY, Atrauma-Pinzette TC.....	99	DOYEN, Darmklemme.....	540
Darmfaßzange, ALLIS-BABY.....	537	DeBAKEY Atrauma-Pinzette TITAN.....	99	DOYEN, gynäkologische Schere.....	63
Darmfaßzange, ATRAUMA.....	539	DeBAKEY, Coarctationsklemme.....	507	DOYEN, Hohlsonde.....	199
Darmfaßzange, BABCOCK.....	539	DeBAKEY-BAHNSON, Aneurysmaklemme.....	506	DOYEN, Myomheber.....	594
Darmfaßzange, BOYS-ALLIS.....	538	DeBAKEY-DIETHRICH, Mini-Bulldogklemme.....	101	DOYEN, Raspator.....	278
Darmfaßzange, COLLIN.....	539	DeBAKEY-MOSQUITO, Atrauma-Arterienklemme.....	509	DOYEN, Scheidenspekula.....	574
Darmfaßzange, DUVAL.....	539	DeBAKEY-PEAN, Atrauma-Arterienklemme.....	513	DOYEN, Schere.....	63
Darmfaßzange, JUDD-ALLIS.....	538	DeBAKEY-RANKIN, Atrauma-Arterienklemme.....	512	DOYEN, Tuchklemme.....	133
Darmfaßzange, LITTLEWOOD.....	538	DEJERINE, Perkussionshammer.....	24	DOYEN, Uterus-Polypenzange.....	585
Darmfaßzange, THOMS-ALLIS.....	538	DEKAPITATIONSHAKEN, BRAUN.....	607	DOYEN, Wundhaken.....	163
Darmfaßzange, WILLIAMS.....	539	DELEE, Scheidenspekula.....	574	DOYEN-BABY, Darmklemme.....	540
Darmklemme, BABY-KOCHER.....	540	DEMEI, Drahtspanninstrument.....	315	DOYEN-JANSEN (MOLT), Mundsperrer.....	454
Darmklemme, BRUNNER.....	543	DEMEI, Drahtumführungsnadel.....	315	DOYEN-STILLE, Wundhaken.....	167
Darmklemme, DE MARTEL-WOLFSON.....	546	DENHART, Mundsperrer.....	454	Drahfäßzange.....	316, 318
Darmklemme, DOYEN.....	540	DENIS-BROWNE, Bauchdeckenhalter.....	185	Drahtgeflecht.....	311
Darmklemme, FEHLAND.....	542	DERF, Nadelhalter.....	208	Drahtkneifzange.....	317, 318, 320
Darmklemme, HAYES.....	545	DERMATOM, HUMBY.....	50	Drahtsäge, OLIVECRONA.....	332
Darmklemme, KOCHER.....	540	DERMATOM, SCHINK.....	49	Drahtschere, UNIVERSAL.....	67
Darmklemme, MAYO-ROBSON.....	541	DERMATOM, SILVER.....	50	Drahtspanninstrument, DEMEL.....	315
Darmklemme, RESANO.....	542	DERMATOM, WATSON.....	50	Drahtspanninstrument, LOUTE.....	315
Darmklemme, SCUDDER.....	541	DERRA, Anastomosenklemme.....	515	Drahtumführungsnadel, DEMEL.....	315
Darmklemme, STONE-WATT.....	545	D'ERRICO, Nervwurzelhaken.....	329/2	Drahtvalven f. Bauchdeckenhalter.....	184
Darmquetschklemme, PAYR.....	548	DESCHAMPS, Unterbindungsnadel.....	218	Drahtzange TC, BERRY.....	319
		DESJARDINS, Arterienklemme.....	121	Drahtzange TC, CORWIN-HEGAR.....	319

Drahtzange TC, MAYO-HABERISSER .....	319	ERRICO, Bohrer .....	299	Fertigschläger, KUENTSCHER .....	321
Dreibackenspannfutter Handgriff .....	300	Ersatzklinge .....	49	Fiberglas-Lichtträger, KLEINSASSER .....	36
DUBOIS, gynäkologische Schere .....	63	Ersatzklinge, steril .....	50	Finger-Goniometer .....	25
DUPLAY, Hakenzange .....	582	Ersatzlampchen .....	29, 30	Fingerringsäge, REDA .....	297
DUPLAY, Kornzange .....	134	Ersatzsägeblätter .....	230	Fingerringsäge, WALTON .....	297
DUPLEX, Stethoskop .....	23	ESMARCH, Gipsmesser .....	233	Fingersäge, LANGENBECK .....	296
DUPUY-WEISS, Tonsillennadel .....	466	ESMARCH, Staubinde .....	296	Fingerschützer, LANGENBECK .....	311
Dura-Dissektor, DAVIS .....	332	ESMARCH, Verbandschere .....	69/2	FINOCHIETTO, Bronchusklemme .....	490
Dura-Dissektor, FRAZIER .....	333	ETHICON, Clipanlagezange .....	524, 525	FINOCHIETTO, Nadelhalter .....	211
Dura-Dissektor, HOEN .....	333	EYES, Tonsillenschnürer .....	468	FINOCHIETTO, Rippensperrerr .....	482, 484
Dura-Dissektor, HORSLEY .....	333	EXACTA, Blutdruckmeßgerät .....	8	FINOCHIETTO-BABY, Rippensperrerr .....	482
Dura-Dissektor, MILLIGAN .....	332	Exenterationslöffel, BUNGE .....	378	FINOCHIETTO-BURFORD, Rippensperrerr .....	483
Dura-Dissektor, OLIVECRONA .....	332	Extensionsbügel, BOEHLER .....	312	FINSEN, Wundhaken .....	168
Dura-Dissektor, SACHS .....	332	Extensionsbügel, KIRSCHNER .....	312	FISCH, Dissektor .....	420
Dura-Dissektor, TOENNIS .....	332	Extensionsbügel, KIRSCHNER US .....	312	FISCH, feines Häkchen .....	335
Dura-Dissektor, WOODSON .....	333	Extraktionsmeißel, ROLLET .....	374	FISCHER, Irispinzette .....	384
Dura-Haken, JACOBSON .....	335	Extraktor .....	322	FISH, Sonde .....	199
Dura-Messer, KOOS .....	335	Extraktionshaken .....	322	FISHER, Tonsillennmesser .....	466
Dura-Haken .....	335	Extraktionshaken, ABRUGA .....	375	Fistelhäkchen, EMMETT .....	594
Dura-Haken, ADSON .....	329	Extraktionshaken, I.U.D. .....	593	Fistelsonde, LOCKHART-MUMMERY .....	200
DURANTE, Faßpinzette .....	88	Extraktor, KUENTSCHER .....	322	Fistelsonde, PRATT .....	563
Dura-Schere, SCHMIEDEN-TAYLOR .....	65/1	F .....		Fixationspinzette, BARRAQUER .....	390
DUVAL, Darmfaßzange .....	539	Face-Lift-Schere, FREEMAN .....	74	Fixationspinzette, ELSCHNIG .....	389
DUVAL, Faßpinzette .....	85	Face-Lift-Schere, GORNEY .....	73	Fixationspinzette, GRAEFE .....	389
Dynamometer, COLLIN .....	25	Face-Lift-Schere, KAYE .....	73	Fixationspinzette, GREEN .....	390
E .....		Face-Lift-Schere, REES .....	73	Fixationspinzette, LESTER .....	389
ECHLIN, Hohlmeißelzange .....	240	Face-Lift-Schere, REES .....	73	Fixiergabel, BURCH .....	373
ECO "C" Diagnostik-Besteck .....	16	Fadengabel, REDA .....	221	Fixierpinzette, CASTROVIEJO .....	390
ECO "T" Diagnostik-Besteck .....	16	Fadengabel f. Tracheotomie .....	475	Fixierpinzette, COTTLE .....	410
EICKEN (KILLIAN), Spülkanüle .....	433	Fadenpinzette, McPHERSON .....	392	Fixierpinzette, GRAEFE .....	83
Ein- u. Ausschlaginstrumente .....	321	Fadenpinzette, Mod. TUEBINGEN .....	392	Fixierpinzette, KIRBY-ARTHUR .....	385
Einmal-Skalpelle, steril .....	43	Fadenpinzette, PAUFIQUE .....	392	Fixiervorrichtung, LEYLA .....	368/4
Einschläger, BENDER .....	322	Fadenschere, HEATH .....	66	Fixiervorrichtung, ROCHARD .....	186
Elektrode, monopolar .....	629	Fadenschere, LITTAUER .....	66	Flachbohrer, CUSHING .....	299
Elektrodenball-Koagulation .....	629	Fadenschere, NORTHBENT .....	66	Flachmeißel .....	259, 264, 267
Elektroden-Drahtschlinge .....	629	Fadenschere, SPENCER .....	66	Flachmeißel, HOKÉ .....	265
Elektroden-Koagulation .....	629	FANSLER, Proktoskop .....	564	Flachmeißel, ALEXANDER .....	259
Elektroden-Lanzette .....	629	FARABEUF, Knochenhaltezeange .....	243	Flachmeißel, BRÜNNINGS-LUCAS .....	260
Elektroden-Nadel .....	629	FARABEUF, Raspator .....	274	Flachmeißel, HIBBS .....	265
Elektroden-Schlinge .....	628, 629	FARABEUF, Wundhaken .....	139	Flachmeißel, LEXER .....	263
Elevator, CHANDLER .....	282	FARABEUF-COLLIN, Raspator .....	274	Flachmeißel, PARTSCH .....	259
Elevator, ALDERDYCE .....	282	FARABEUF-LAMBOTTE, Knochenhaltezeange .....	243	Flachmeißel, STILLE .....	260
Elevator, BOIES .....	277	FARRELL, Watteträger .....	203	Flachzange .....	316, 317
Elevator, CREGO .....	282	Faßpinzette .....	305	flexible Faßzange, SERPENTINE-GRASPER .....	593
Elevator, DINGMANN .....	463/3	Faßpinzette, COLLIN-DUVAL .....	85	flexible Hirnspaltthalter, LEYLA .....	368/2
Elevator, FREER .....	434	Faßpinzette, DURANTE .....	88	flexibler Spannarm, LEYLA .....	368/3
Elevator, KEY .....	282	Faßpinzette, DUVAL .....	85	FOERSTER, Irispinzette .....	383
Elevator, LEMPERT .....	420	Faßpinzette, LERCHE .....	83	FOERSTER, Tupferzange .....	136
Elevator, McDONALD .....	283	Faßpinzette, RUSS. MODELL .....	85	FOMON, Hauthäkchen .....	447/1
Elevator, MURPHY-LANE .....	283	Faßzange .....	316	FOMON, Nasenhaken .....	447/1
Elevator, SAYRE .....	281	Faßzange, SERPENTINE-GRASPER .....	593	FOMON, Nasenraspel .....	444
Elevator, WATSON-CHEYNE .....	283	Faßzange, MARTEL .....	110	FOMON, Nasenschere .....	58
Elevatoren .....	280	Faßzange, PRATT .....	110	FOMON, Raspator .....	277
ELLIOT, Geburtszange .....	602	Faßzange, WILLET-MARTEL .....	110	FOMON, Rhinoplastschere .....	65/1
ELLIS, Fremdkörperhohlmeißel .....	374	FAULKNER, Kürette .....	449	FOMON, Septummeißel .....	441
ELSCHING, Fixationspinzette .....	389	FAURE, Biopsiezange .....	588	FOMON, Nasenraspel TC .....	445
ELSCHING, Hornhautmesser .....	373	FAURE, Peritoneumklemme .....	123	FOX, Lupuskürette .....	608
ELSCHING, Kapsel-pinzette .....	391	FAVALORO, Gefäßschere .....	61	FRAENKEL, Aufsatz .....	472
ELSCHING, Zyklodialysespatel .....	379	FEHLAND, Darmklemme .....	542	FRAENKEL, Kehlkopfpolypezange .....	471
EMMETT, Fistelhäkchen .....	594	FEILCHENFELD, Splitterpinzette .....	91	FRANCIS, Fremdkörpermadel .....	374
Enderterektomie-Stripper .....	202	FELDHEIM, Knochenhalteklammer .....	249	FRANKLIN-SILVERMANN, Biopsiekanüle .....	206
Endernagel, STEINMANN .....	307, 308	FERGUSSON, chirurgische Schere .....	66	FRAZIER, Bauchdeckenhalter .....	181
Endoskopiekorb .....	623	FERGUSSON, Saugrohr .....	337	FRAZIER, Dura-Dissektor .....	333
Endospekula, KOGAN .....	577	FERGUSSON, Gallensteinlöffel .....	533	FRAZIER, Hauthäkchen .....	149
ENGEL, Gipssäge .....	229	FERGUSSON, Hämorrhoidal-klemme .....	109	FRAZIER, Punktionskanüle .....	337
Enukleations-Löffel, WELLS .....	378	FERGUSSON, Knochenhaltezeange .....	243	FRAZIER/FERGUSSON, Saugrohr .....	337
Epiotomie-Schere, WALDMANN .....	64	FERGUSSON, Saugrohr .....	337	FREEMAN, Face-Lift-Schere .....	74
Epiotomie-Schere, BRAUN-STADLER .....	64	FERRIERA, Wundhaken .....	197	FREEMAN, Wundhaken .....	198
EPKER, Osteotome .....	464/2	FERRIS-SMITH, Laminektomiezeange .....	343	FREER, Elevatorium .....	434
EPPENDORFER, Uterus-Biopsiezange .....	590	FERRIS-SMITH, chirurgische Pinzette .....	85	FREER, Hauthäkchen .....	448
ERBE, Verbindungskabel .....	633	FERRIS-SMITH-KERRISON, Bandscheibenstanze .....	344, 344/2	FREER, Mukosamesser .....	434
ERBE/SELECT, Verbindungskabel .....	633	FERRIS-SMITH-KERRISON, zerlegbare Stanze .....	344/2	FREER, Nasenmesser .....	434
				FREER, Septumhohlmeißel .....	442/1



FREER, Septumellevator.....	437, 439	Geburtszange, SIMPSON.....	602	GOMMEL, mikro-chirurgische Pinzette.....	96
FREER, Septummeißel.....	439	Geburtszange, SIMPSON-BRAUN.....	602	GOMMEL, Mikro-Schere.....	80
FREER, Septummesser.....	434	Geburtszange, SIMPSON-LUIKART.....	603	Goniometer f. Finger.....	25
Fremdkörperflächmeißel, DIX.....	374	Geburtszange, TARNIER.....	604	Goniotomiemesser, SCHEIE.....	373
Fremdkörperhebel, BUCK.....	412	Geburtszange, WRIGLEY.....	602	Goniotomiemesser, BARKAN.....	373
Fremdkörperhebel, QUIRE.....	412	Geburtszangen.....	602 - 604	GOOD, Tonsillenschere.....	59
Fremdkörperhöhlmeißel, ELLIS.....	374	Gefäßclip, BIEMER.....	361	GOODELL, Uterus-Dilatator.....	581
Fremdkörperhöhlmeißel, WALTON.....	374	Gefäßclip, MEHDORN.....	362	GORNEY, Dissektor.....	277
Fremdkörperinstrument, DIX.....	380	Gefäßclip, MÜLLER.....	365	GORNEY, Face-Lift-Schere.....	78
Fremdkörperkürette, ALVIS.....	374	Gefäßclip, YASARGIL.....	345 - 356	GOSSET, Bauchdeckenhalter.....	173
Fremdkörpernadel.....	374	Gefäßdilator, DeBAKEY.....	529	GOURDET, Uteruslöffel.....	599
Fremdkörpernadel, DAVIS.....	374	Gefäßdissektor, ROBB.....	530	GRADLE, Cilienpinzette.....	395
Fremdkörpernadel, FRANCIS.....	374	Gefäßklemme, DeBAKEY.....	494 - 496	GRADLE, Ophthalmologie-Schere.....	57
Fremdkörpernadel, LA FORCE.....	374	Gefäßklemme, DIEFFENBACH.....	104	GRAEFE, Fixierpinzette.....	83
Fremdkörpernadel, LEVINSON.....	374	Gefäßklemme, LELAND-JONES.....	494	GRAEFE, Hauthäkchen.....	149
Fremdkörperzängchen, HARTMANN.....	412	Gefäßklemme, POTTS.....	492, 493	GRAEFE, Irispinzette.....	382
Fremdkörperzängchen, HARTMANN-HOFFMANN.....	412	Gefäßklemme, SATINSKY.....	491	GRAEFE, Schere.....	56
Fremdkörperzängchen, HARTMANN-WULLSTEIN.....	412	Gefäßklemmen, atrauma.....	492 - 523, 526, 527	GRAEFE, Schielhaken.....	375
Fremdkörperzängchen, STRUEMPEL.....	412	Gefäßpinzette, ADLERKREUTZ.....	84	GRAEFE, Starlöffel.....	377
Fremdkörperzange, MATHIEU.....	553/1	Gefäßpinzette, NELSON.....	89	GRAEFE, Starmesser.....	371
FRENZEL, Nystagmusbrille.....	20	Gefäßpinzette, WANGENSTEEN.....	89	GRAEFE, Cystostom.....	375
FRENZEL, Zungenspatel.....	451	Gefäßpinzette, STILLE-BARRAYA.....	88	GRAEFE, Diszionsmesser.....	372
FRIEDMAN, Hohlmeißelzange.....	234	Gefäßschere, DeBAKEY.....	61	GRAEFE, Fixationspinzette.....	389
FRIEDMAN-Mini, Hohlmeißelzange.....	234	Gefäßschere TC, DeBAKEY.....	60	GRAEFE, Schielhaken.....	375
FRIEDMANN, Spekula.....	577	Gefäßschere, DIETRICH.....	60	GRAEFE, Lidsperrer.....	370
FRITSCH, Wundhaken.....	163	Gefäßschere, FAVALORO.....	61	GRAHAM, Nervhaken.....	329
FRYKHOLM, Hohlmeißelzange.....	240	Gefäßschere, KELLY.....	61	GRAIG, Septumzange.....	426
FUCHS, Kapselpinzette.....	391	Gefäßschere, KLINKENBERG-LOTH.....	65/2	GRAVE, Scheidenspekula.....	570
FUCHSIG, Arterienklemme.....	113	Gefäßschere, POTTS-DE MARTEL.....	59	GRAY, Arterienklemme.....	121
Führungshohlsonde, KOENIG.....	221	Gefäßschere, POTTS-SMITH.....	61	GREEN, Fixationspinzette.....	390
Führungshohlsonde, KIRSCHNER.....	221	Gefäßschere, SATINSKY.....	65/2	GREEN, Hornhautdissektor.....	374
Führungshohlsonde, SCHMIEDEN-PAYR.....	221	Gefäß-Spülkanüle, SCHMID.....	338	GREEN, Muskelhäkchen.....	375
Führungshohlsonde, BRUNNER.....	221	GELPI, Bauchdeckenhalter.....	189/1, 189/2	GREEN, Wundhaken.....	160
Führungshohlsonde, PAYR.....	221	GELPI, Haken.....	193	GREEN-ARMYTAGE, Uteruszange.....	605
Führungshohlsonde, SCHMIEDEN.....	221	GEMINI, Arterienklemme.....	115	GREGORY, Profundaklemme.....	517
Führungshohlsonde, VIENNA.....	221	GERALD, anatomische Pinzette.....	86	GREVEN, Mikro-Ohrzängchen.....	414
Führungsinstrument, DE MARTEL.....	330	GERALD, chirurgische Pinzette.....	87	Griff allein f. Uterus-Biopsiezangen.....	591
Führungsnadel, REDON.....	207	GERSTER, Knochenhalteklammer.....	250	Griff f. Kehlkopfspiegel.....	473
Führungsspiß.....	321	GERZOG, Hammer.....	270	Griff f. SCHERBAK.....	575
G		Gewebefäßpinzette, BROWN.....	83	Griff f. Stabinstrumente, Tracheotomie.....	475
Galeahaken, YASARGIL.....	330	Gewebefäßpinzette, SINGLEY.....	88	Griff f. Meißel.....	266
GALLAHER, Antrumraspel.....	446	Gewebefäßzange, CHAPUT.....	110	Griff f. Osteotome.....	266
Gallenblasenschere, THOREK.....	65/2	Gewebefäßzange, COLLIN.....	110	Griff f. Skalpell.....	38 - 41
Gallengangdilator, BAKES.....	532	Gewebefäßzange, TUFFIER.....	110	Griffe f. Skalpell Mini.....	41
Gallensteiniöfel, MOOR.....	532	Gewicht f. AUVARD.....	576	GROSS, Ohrlöffel.....	409
Gallensteiniöfel, DESJARDINS.....	534	Gewicht f. SCHERBAK.....	575	GROSS-MAIER, Kornzange.....	134
Gallensteiniöfel, FERGUSON.....	533	GIERTZ-STILLE, Rippenschere.....	481	GRUBER, Ohrspekula.....	399
Gallensteiniöfel, LUER-KOERTE.....	533	GIGLI, Säge.....	332	GUILLEN, Saugraspatorium.....	433/1
Gallensteiniöfel, MAYO.....	534	GILL, Hornhautmesser.....	373	Gummibirme f. POLITZER.....	406
Gallensteinsonde, DESJARDINS.....	532	GILL, Irispinzette.....	384	Gummiringe-Ligatur f. MC GIVNEY.....	568
Gallensteinsonde, MOYNIHAN.....	532	GILL-ARRUGA, Kapselpinzette.....	390	GUTHRIE, Hauthäkchen.....	149
Gallensteinsonde, MAYO.....	534	GILL-HESS, Irispinzette.....	384	GUYON, Arterienklemme.....	122
Gallensteinzange, BLAKE.....	531	GILLIES, chirurgische Pinzette.....	86	GUYON, Dilatationsbougie.....	554
Gallensteinzange, DESJARDINS.....	531	GILLIES, Hauthäkchen.....	448	GUYON, Katheter-Einführungsinstrument.....	554
Gallensteinzange, MIXTER.....	531	GILLIES, Nadelhalter.....	212	GUYON, Nierenklemme.....	122
Gallesteinzange, MAYO-BLAKE.....	531	GIL-VERNET, Wundhaken.....	152	GUYTON-LUNGSGAARD, Sklerotom.....	373
GASS, Häkchen.....	376	Gipsabreißzange, WOLFF.....	233	Gynäkologie-Schere, DOYEN.....	63
GAUSS, Kopfschwarte.....	605	Gipsmesser, ESMARCH.....	233	Gynäkologie-Schere, DUBOIS.....	63
Geburtslöffel, SELLHEIM.....	607	Gipsmesser, HOPKINS.....	233	Gynäkologie-Schere, SIEBOLD.....	62
Geburtszange, BARTON.....	603	Gipsmesser, REINER.....	233	Gynäkologie-Schere, SIMS.....	62
Geburtszange, BOERMA.....	604	Gipsmesser, WIGMORE.....	229	H	
Geburtszange, DE LEE.....	602	Gipssäge, elektrisch.....	230	HABERER, Dammspatel.....	143/1
Geburtszange, ELLIOT.....	602	Gipssäge, ENGEL.....	229	Hämorrhoidal-Klemme, FERGUSON.....	109
Geburtszange, KIELLAND.....	602	Gippschere, STILLE.....	229	Hämorrhoidal-Ligatur, MC GIVNEY.....	568
Geburtszange, KIELLAND-LUIKART.....	603	Gipsspreizer, REDA.....	232	HAGLUND-STILLE, Gipsspreizer.....	232
Geburtszange, LUIKART.....	603	Gipsspreizer, BEESON.....	232	HAIGHT, Rippensperre.....	487
Geburtszange, McLEAN.....	603	Gipsspreizer, HAGLUND-STILLE.....	232	HAJEK, Hammer.....	273
Geburtszange, McLEAN-LUIKART.....	603	Gipsspreizer, HENNIG.....	232	HAJEK, Septummeißel.....	442/1
Geburtszange, McLEAN-TUCKER.....	603	GLOVER, Bulldogklemme.....	103	HAJEK, Septummeißel.....	439
Geburtszange, McLEAN-TUCKER-LUIKART.....	603	GLOVER, Mehrzweckklemme.....	515, 518, 519	HAJEK-KOFLER, Stanze.....	429, 431
Geburtszange, NAEGELE.....	602	GLUCK, Rippenschere.....	480	Häkchen, BARBARA.....	419
Geburtszange, PIPER.....	604	GOELET, Wundhaken.....	141	Häkchen, CLAYMAN.....	376
		GOLDMANN-FOX, Zahnfleischschere.....	67		

Häkchen, DAY .....	409	Handgriff Dreibackenspannfutter .....	300	HIBBS, Osteotome .....	265
Häkchen, FISCH .....	335	Handgriff f. Stabinstrumente f. Tracheotomie .....	475	HIBBS, Wundhaken .....	164
Häkchen, GASS .....	376	Handwaschbürste .....	611	HILL-FERGUSON, Rektal-Spekulum .....	560
Häkchen, KUGLEN .....	376	HANK, Dilator .....	580	Hirnmesser .....	48
Häkchen, LUCAE .....	409	HANK, Uterus-Dilatator .....	580	Hirnspatel, CUSHING .....	336, 369
Häkchen, McGEE .....	419	HARGIS, Raspator .....	463/2	Hirnspatel, HEIFETZ .....	369
Häkchen, SHAMBAUGH .....	419	HARGIS, Unterkieferhaken .....	463, 463/6	Hirnspatel, OLIVECRONA .....	336
Häkchen, SINSKEY .....	376	HARGIS, Wundhaken .....	463	Hirnspatelhalter, LEYLA .....	368/2
Häkchen f. Tracheotomie .....	475	HARKEN, Aurikelklemme .....	503	HIRSCHMANN, Anuskop .....	562
Häkchen, WAGENER .....	409	HARM, Sonde .....	381	HIRSCHMANN, Zykliodialsyespatel .....	379
Haken, BALFOUR .....	193	HARRINGTON, Bronchusklemme .....	490	Handgriff f. NABATOFF .....	201
Haken, GELPI .....	193	HARRINGTON, Haken .....	193	Hochfrequenz-Chirurgie .....	628, 629
Haken, HARRINGTON .....	193	HARRINGTON, Wundhaken .....	147	HOEN, Dura-Dissektor .....	333
Haken, KELLY .....	193	HARRINGTON-PEMBERTON, Wundhaken .....	147	HOESEL, Nadelhalter .....	213
Haken, KIRSCHNER .....	185, 187	HARTMANN, Nasenzange .....	427	HOFFER, Wundhaken .....	465
Haken, SCOVILLE .....	196	HARTMANN, Arterienklemme .....	104	HOFFMANN, Schlauchklemme .....	624
Haken, SMELLIE .....	605	HARTMANN, Ohrzängchen .....	411	Hohlmeißel .....	259, 264
Haken, TAYLOR .....	196	HARTMANN, Fremdkörperzängchen .....	412	Hohlmeißel, PARTSCH .....	259
Haken, TESSIER .....	463/3	HARTMANN, Nasenspekula .....	422	Hohlmeißel, ALEXANDER .....	259
Hakenzange, BARRET .....	582	HARTMANN, Ohrkatheter .....	408	Hohlmeißel, COBB .....	262
Hakenzange, BRAUN .....	582	HARTMANN, Ohrspekula .....	399	Hohlmeißel, HIBBS .....	265
Hakenzange, CZERNY .....	584	HARTMANN, Polypenzange .....	424	Hohlmeißel, KILLIAN .....	442/1
Hakenzange, DUPLAY .....	582	HARTMANN, Spülkanüle .....	433	Hohlmeißel, LEXER .....	263
Hakenzange, HULKA .....	583	HARTMANN, Stimmgabel .....	403	Hohlmeißel, LEXER-Mini .....	263
Hakenzange, IOWA .....	584	HARTMANN, Zungendrucker .....	452	Hohlmeißel, NOVOTEX .....	264
Hakenzange, JACOBS .....	583	HARTMANN-HALLE, Nasenspekula .....	421	Hohlmeißel, SMITH-PETERSEN .....	261
Hakenzange, JARCHO .....	583	HARTMANN-HOFFMANN, Fremdkörperzängchen .....	412	Hohlmeißel, WEST .....	442/1
Hakenzange, MUSEUX .....	583	HARTMANN-WULLSTEIN, Fremdkörperzängchen .....	412	Hohlmeißel, ZIELKE .....	264
Hakenzange, PRATT .....	584	HAUGH, Mikro-Ohrzängchen .....	414	Hohlmeißel, STILLE .....	260
Hakenzange, SCHRÖDER .....	583	Hauthäköchen, COTTLE .....	447/1	Hohlmeißelzange, FRIEDMAN .....	234
Hakenzange, SCHRÖDER .....	584	Hauthäköchen, COTTLE-NEIVERT .....	448	Hohlmeißelzange, ADSON .....	236
Hakenzange, SCHRÖDER (POZZI) .....	582	Hauthäköchen, FOMON .....	447/1	Hohlmeißelzange, BANE-HARTMANN .....	237
Hakenzange, SKENE .....	582	Hauthäköchen, FRAZIER .....	149	Hohlmeißelzange, BLUMENTHAL .....	236
Hakenzange, STAUDE-MOORE .....	582	Hauthäköchen, FREER .....	448	Hohlmeißelzange, BOEHLER .....	238
Hakenzange, TEALE .....	583	Hauthäköchen, GILLIES .....	448	Hohlmeißelzange, CLEVELAND .....	235
HALLE, scharfer Löffel .....	253	Hauthäköchen, GRAEFFE .....	149	Hohlmeißelzange, ECHLIN .....	240
HALLE, Septumellevator .....	437	Hauthäköchen, GUTHRIE .....	149	Hohlmeißelzange, FRIEDMAN-Micro .....	234
Halogenlampe .....	29	Hauthäköchen, JOSEPH .....	149	Hohlmeißelzange, FRIEDMAN-Mini .....	234
HALSEY, Nadelhalter .....	208	Hauthäköchen, KILNER .....	608	Hohlmeißelzange, FRYKHOLM .....	240
HALSTED-MOSQUITO, Arterienklemme .....	105	Hauthäköchen, KLEINERT-KUTZ .....	149	Hohlmeißelzange, JANSEN .....	237
Haltearm f. LEYLA .....	368/1	Hauthäköchen, REDA .....	150	Hohlmeißelzange, KLEINERT-KUTZ .....	237
Halteklemme, ADSON .....	298	Hautschere .....	610	Hohlmeißelzange, LEMPERT .....	237
Halter für Hirnspatel, LEYLA .....	368/4	Haut-Trephinen, KEYE .....	608	Hohlmeißelzange, LUER .....	236
Halter, KALLMORGEN .....	573	HAYES, Darmklemme .....	545	Hohlmeißelzange, MARQUARDT .....	239
Halter, KRISTELLER .....	572	HAYES, Rektum-Anastosenklemme .....	545	Hohlmeißelzange, MAYFIELD .....	238
Halterahmen .....	187	HEANEY, Hysterektomieklammer .....	126	Hohlmeißelzange, MEAD .....	235
Hammer .....	270, 271, 273	HEANEY, Nadelhalter .....	210	Hohlmeißelzange, OLIVECRONA .....	237
Hammer, BERGMANN .....	272	HEANY, Biopsiekurette .....	587	Hohlmeißelzange, RUSKIN .....	239
Hammer, COLLIN .....	270	HEANY, Wundhaken .....	164	Hohlmeißelzange, SAUERBRUCH .....	240
Hammer, COTTLE .....	273	HEANY-BALLENTINE, Hysterektomieklammer .....	127	Hohlmeißelzange, SCAGLIETTI .....	240
Hammer, GERZOG .....	270	HEATH, Fadenschere .....	66	Hohlmeißelzange, SEMB .....	240
Hammer, HAJEK .....	273	HEATH, Hammer .....	273	Hohlmeißelzange, SMITH-PETERSEN .....	238
Hammer, HEATH .....	273	HEBRA, Chalazionskurette .....	377	Hohlmeißelzange, STELLBRINK .....	234
Hammer, KIRK .....	270	HEGAR, Uterus-Dilatator .....	578, 579	Hohlmeißelzange, ZAUFLAK-JANSEN .....	238
Hammer, LUCAE .....	271	HEGENBARTH, Wundklammerpinzette .....	224	Hohlmeißelzange, LEKSELL (STILLE) .....	240
Hammer m. Ferrozellgriff .....	272	HEIFETZ, Hirnspatel .....	369	Hohlmeißelzange, STILLE-LUER .....	239
Hammer, MEAD .....	271	HEIMING, Nierensteinzange .....	536	Hohlmeißelzange, STILLE-RUSKIN .....	239
Hammer, OMBREDANNE .....	273	HEISS, Arterienklemme .....	112	Hohlsonde .....	199
Hammer, PARTSCH .....	271	HEISTER, Mundsperr .....	454	Hohlsonde, BRODIE .....	199
Hammer, QUISLING .....	271	HENKE, Tonsillenelevator .....	465	Hohlsonde, DOYEN .....	199
Hammer, WILLIGER .....	271	HENLEY, Wundspreizer .....	170	Hohlsonde, NELATON .....	199
Hämorrhoidal-Ligator .....	568	HENNING, Gipsspreizer .....	232	HOHMANN, Knochenhebel .....	284, 285
Hämorrhoidal-Ligator, RUDD .....	568	HEPP-SCHIEDEL, Mikro-Schere .....	78	HOHMANN-Mini, Knochenhebel .....	286
Hämorrhoidal-Zange, MC GIVNEY .....	568	HERRICK, Nierenstielklemme .....	123	HOKE, Flachmeißel .....	265
Hämorrhoidal-Zange, HEYWOOD-SMITH .....	568	HESS, Irispinzette .....	384	HOKE, Osteotome .....	265
Handbohrapparat, MOORE .....	298	HESS, Kapselpinzette .....	391	HOLINGER, OP-Laryngoskop .....	37
Handbohrapparat, BUNELL .....	299	HESS, Nervwurzelhaken .....	329/1	HOLLINGER, Lichtträger .....	37
Handbohrapparat, HUDSON .....	299	HEYMANN, Nasenschere .....	58	HOLSHER, Nervwurzelhaken .....	329/1
Handbohrapparat, KIRSCHNER .....	299	HEYMANN, Septumzange .....	425	HOLTH, Kapselstanze .....	380
Handbohrapparat, RALD .....	300	HEYMANN-KNIGHT, Polypenzange .....	425	HOLZBACH, Hysterektomieklammer .....	126
Handbohrapparat, REDA .....	300	HEYWOOD-SMITH, Hämorrhoidalzange .....	567	HOLZHEIMER, Wundhaken .....	168
Handbohrapparat, STILLE .....	298	HIBBS, Flachmeißel .....	265	HOPKINS, Gipsmesser .....	233
Handgriff .....	300	HIBBS, Hohlmeißel .....	265	HORGAN, Valve f. Bauchdeckenhalter .....	183

HORIZON, Clipanlagezange.....	524, 525	Irisspatel, WECKER.....	378	Kapsel­faßzange, MILLIN.....	550, 551
Hornhautdissektor, GREEN.....	374, 375	ISRAEL, Wundhaken.....	162	Kapsel­pinzette, ARRUGA.....	391
Hornhautdissektor, PATON.....	373	ITERSON, Trachealhaken.....	477	Kapsel­pinzette, CASTROVIEJO.....	391
Hornhautmesser, ELSCHNIG.....	373	IVES-FANSLER, Anuskop.....	562	Kapsel­pinzette, ELSCHNIG.....	391
Hornhautmesser, GILL.....	373	WANSON, Meßgerät.....	624	Kapsel­pinzette, FUCHS.....	391
Hornhautmesser, SATO.....	373			Kapsel­pinzette, GILL-ARRUGA.....	390
Hornhautmesser, TOOK.....	373	J.....		Kapsel­pinzette, HESS.....	391
Hornhautschaber, KUHN.....	373	JACKSON-BURROWS, Bauchdeckenhalter.....	189/2	Kapsel­pinzette, KALT.....	391
Hornhautschere, CASTROVIEJO.....	79	JACKSON, Kehlkopf­pinzette.....	471	Kapsel­pinzette, SCHWEIGGER.....	391
HORSLEY, Dura-Dissektor.....	333	JACKSON, Laryngoskop.....	37	Kapsel­pinzette, TERSON.....	391
HÖSEL, Wundhaken.....	167	JACKSON, Pinzette.....	471	Kapselschere, RESANO.....	53/2
HOUSE, Kurette.....	420	JACKSON, Scheidenspekula.....	573	Kapselstanze, HOLTH.....	380
HOUSE, Mikro-Meßsonde.....	420	JACKSON, Sehnen­faßzange.....	292	Katheter­ein­füh­rungs­in­stru­ment, GUYON.....	554
HOUSE, Saugrohr.....	337/2	JACKSON, Trachelhaken.....	476	Katheter­ein­füh­rungs­zange, MAGILL.....	28
HOWARTH, Septum­ele­va­tor.....	438	JACOBS, Hakenzange.....	583	Katheter­klemme, COOLEY.....	510
HUBER, Univer­sal­griff.....	472	JACOBSON, Arterien­klemme.....	105	KAYE, Face-Lift-Schere.....	73
HUDSON, Hand­bo­hr­ap­pa­rat.....	299	JACOBSON, Dura-Haken.....	335	Kegel f. SCHULTZE Salpingograph.....	596
HUDSON, T-Handgriff.....	300	JACOBSON, Knopfsonde.....	335	Kehldeckelhalter, REICHERT.....	471
HULKA, Hakenzange.....	583	JACOBSON, Nadelhalter.....	215	Kehlkopfkanüle.....	470
HUMBLY, Dermatom.....	50	JACOBSON, scharfer Löffel.....	257	Kehlkopf­pin­zette, JACKSON.....	471
HUNTER, Splitter­pin­zette.....	91	JAEGER, Lanzen­messer.....	372	Kehlkopf­poly­pen­zange, FRAENKEL.....	471
HURD, Tonsillen-Dissektor.....	465	JAEGER, Lidplatte.....	371	Kehlkopf­poly­pen­zange, JURASZ.....	471
Hypophysenkürette.....	334	JAMESON, Schielhaken.....	375	Kehlkopf­spie­gel.....	473
Hypophysenzange.....	341	JAMESON, Strabismus­pin­zette.....	385	Kehlkopf­spie­gel, MICHEL.....	423
Hypophysen­pin­zette, ADSON.....	334	JANSEN, Hohlmeißelzange.....	237	Kehlkopf­spie­gel-Griff.....	473
Hypophysen­pin­zet­ten.....	334	JANSEN, Nasen­pin­zette.....	424	Kehlkopf­spritze.....	470
Hysterektomieschere, WERTHEIM.....	63	JANSEN, scharfer Löffel.....	257	KEINSASSER, OP-Laryngoskop.....	35
Hysterektomie­klemme, HOLZBACH.....	126	JANSEN, Wundhaken.....	168	KEITH, Nadel.....	223
Hysterektomie­klemme, SEGOND-LANDAU.....	125	JANSEN-GRUENWALD, Nasen­pin­zette.....	424	KELLY, Anuskop.....	562, 563
Hysterektomie­klemme, HEANEY.....	126	JARCHO, Hakenzange.....	583	KELLY, Arterien­klemme.....	106
Hysterektomie­klemme, HEANY-BALLENTINE.....	127	JAVID, Carotis-Shunt­klemme.....	511	KELLY, Gefäßschere.....	61
Hysterektomie­klemme, ROGERS.....	127	JENNINGS, Mund­sperr­er.....	454	KELLY-GRIP, Wundhaken.....	142
Hysterektomie­klemme, WERTHEIM.....	124, 128	JENSEN, Augenkanüle.....	394	KELLY, Proktoskop.....	563, 564
Hysterektomie­klemme, SEGOND.....	125	JOBSON-HORNE, Watterträger.....	203	KELLY, Uterus-Polypenzange.....	585
I.....		JOHNS-HOPKINS, Anlegezange.....	104	KELLY, Wundhaken.....	164, 193
I.U.D., Extraktionshaken.....	593	JOHNS-HOPKINS, Arterien­klemme.....	120	KELLY-RANKIN, Arterien­klemme.....	106
Impuls­schlüssel.....	231/3	JOHNS-HOPKINS, Bulldogklemme.....	104	Keratoplastik-Messer, BARRAQUER.....	373
Impaktor.....	322	JOHNSON, Nadelhalter.....	211	Keratoplastik-Messer PAUFIQUE.....	373
INGE, Wirbelkörperspreizer.....	339	JONES, Tuchklemme.....	132	KERN, Knochen­halte­zange.....	244
Injektionskanüle.....	36	JONES-CLIP, Tuchklemme.....	132	KERRISON, Stanze.....	428
INSTRU-CARE, Instrumentenöl.....	634	JORGENSEN, Präparierschere.....	53	KEVORKIAN, Biopsiekürette.....	587
Instrumente f. Tracheotomie.....	475	JOSEF, Nasen­messer.....	434, 435	KEVORKIAN, Uterus-Biopsiezange.....	589, 591
Instrumentenbox.....	617	JOSEPH (LEWIS), Nasenraspel.....	443	KEVORKIAN-PACIFIC, Uterus-Biopsiezange.....	592
Instrumenten­kasten.....	617	JOSEPH, chirurgische Schere.....	54	KEY, Elevator.....	282
Instrumentenöl, INSTRU-CARE.....	634	JOSEPH, Haut­häk­chen.....	149	KEYES, Trepheine.....	608
Insuflationskanüle, VERESS.....	206	JOSEPH, Nasen­messer.....	434	Kieferhöhlenstanze, HAJEK-KOFLER.....	429, 431
Intraorale Retraktoren.....	463/1, 463/4	JOSEPH, Nasenraspel.....	443	Kieferhöhlenstanze, KERRISON.....	428
Inzisions­schere.....	52	JOSEPH, Nasensäge.....	446	Kieferhöhlen­trok­kar, COAKLEY.....	204
IOWA, Hakenzange.....	584	JOSEPH, Raspator.....	277	Kieferhöhlen­trok­kar, DOUGLAS.....	204
IOWA, Nadelführer.....	206	JOSEPH, Septum­ele­va­tor.....	437	Kieferhöhlen­trok­kar, LICHTWITZ.....	204
IRIS, Schere.....	54	JUDD-ALLIS, Darm­faß­zange.....	538	Kieferhöhlen­trok­kar, PIERCE.....	204
Irisschere, KNAPP.....	55	JUDD-MASSON, Blasen­wund­sprei­zer.....	552	KIELLAND, Geburtszange.....	602
Irisschere, LITTLER.....	55	JUERS, Mikro-Ohr­zän­gchen.....	414	KIELLAND-LUIKART, Geburtszange.....	603
IRIS, Supercut­schere.....	72	JURASZ, Kehlkopf­poly­pen­zange.....	471	KILLIAN, Hohlmeißel.....	442/1
Irishäkchen, O'CONNOR.....	375	JURASZ, Zange.....	471	KILLIAN, Nasenspekula.....	423
Irishäkchen, WIENER.....	375	K.....		KILLIAN, Septum­ele­va­tor.....	438, 439
Irismesser, DEAN.....	372	Kabel, bipolar.....	633	KILLIAN, Septum­schere.....	471
Irismesser, KNAPP.....	372	KABERSKE, Pulver­blä­ser.....	405	KILLIAN, Spülkanüle.....	433, 433/1
Irismesser, ZIEGLER.....	372	KADER, Bauch- u. Darm­spatel.....	143/1	KILLIAN-CLAUS, Septum­hohl­meißel.....	442/1
Iris­pin­zette, BARRAQUER.....	384	KALLMORGEN, Halter.....	573	KILNER, chirurgische Schere.....	54
Iris­pin­zette, BARRAQUER-KATZIN.....	384	KALLMORGEN, Speku­la.....	573	KILNER, Haut­häk­chen.....	608
Iris­pin­zette, BISHOP-HARMAN.....	386	KALLMORGEN, Speku­la.....	573	KILNER, Nadelhalter.....	212
Iris­pin­zette, BONN.....	387	KALT, Kapsel­pin­zette.....	391	KILNER, Nasenhaken.....	447/1
Iris­pin­zette, FISCHER.....	384	KALT, Nadelhalter.....	214	KILNER, Supercut­schere.....	72
Iris­pin­zette, FOERSTER.....	383	KALT-ARRUGA, Nadelhalter.....	214	KILNER-DOUGHTY, Mund­sperr­er.....	456
Iris­pin­zette, GILL.....	384	Kaltlicht­klammer für Amnioskope.....	601	Kinder-Atrauma-Gefäßklemme.....	526, 527
Iris­pin­zette, GILL-HESS.....	384	Kaltlicht­träger, HOLLINGER.....	37	Kinder-Aortaklemme, SUBRAMANIAN.....	521
Iris­pin­zette, GRAEFE.....	382	Kaltlicht­träger, JACKSON.....	37	Kinder-Aortaklemme, SUBRAMANIAN-MINITURE.....	521
Iris­pin­zette, HESS.....	384	KANE, Nabel­sch­nur­klemme.....	605	Kinder-Gefäßklemme, SUBRAMANIAN.....	521
Iris­pin­zette, TROUTMAN.....	384	KANTROWITZ, Arterien­klemme.....	119/1	Kinder-Gefäßklemme, SUBRAMANIAN-MINITURE.....	521
Iris­pin­zette, STEVENS.....	383	Kanüle f. Saug­griff ZÖLLNER u. WULLSTEIN.....	337/1	Kinder-Gefäßklemmen.....	527
Irisspatel, CULLER.....	378	Kappenzange, REDA.....	615	Kinder-Gefäßklemmen, atrauma.....	523
				Kinder-Gefäßklemmen, COOLEY.....	522

KIRBY-ARTHUR, Fixierpinzette .....	385	Knochenhebel, BLOUNT .....	288	Kugelgelenkkloben, LEYLA .....	368/1
KIRK, Hammer .....	270	Knochenhebel, BUCK-GRAMCKO .....	285	KUGLEN, Häkchen .....	376
KIRSCHNER, Bauchdeckenhalter .....	185, 187, 187/1	Knochenhebel, HOHMANN .....	284, 285	KUHN, Hornhautschaber .....	373
KIRSCHNER, Bohrdraht .....	306, 307	Knochenhebel, HOHMANN Mini .....	286	KÜMME, Bauch- u. Darmspatel .....	143/2
KIRSCHNER, Extensionsbügel .....	312	Knochenhebel, KÖNIG .....	284	KÜNTSCHER, Aufreiber .....	321
KIRSCHNER, Führungshohlsonde .....	221	Knochenhebel, SMILLIE .....	291	KÜNTSCHER, Extraktor .....	322
KIRSCHNER, Haken .....	185, 187	Knochenhebel, SMILLIE .....	291	KÜNTSCHER, Fertigschläger .....	321
KIRSCHNER, Handbohrapparat .....	299	Knochenhebel, SMILLIE .....	291	KÜNTSCHER, Vorbohrer .....	321
KIRSCHNER US, Extensionsbügel .....	312	Knochenhebel, SMILLIE .....	291	Kupplungskopf, LEYLA .....	368/1
KIRSCHNER, Zughaken .....	313	Knochenhebel, SMILLIE .....	291	Kürette .....	612
Klammeranlegezange, RANEY .....	327	Knochenraspel .....	294	Kürette, ANTRUM .....	435
Klammerhalter .....	326	Knochenraspel, PUTTI .....	294	Kürette, COBB .....	252
KLAPP, Wundhaken .....	150	Knochenraspel, PUTTI .....	294	Kürette, FAULKNER .....	449
KLEINERT-KUTZ, Hauthäkchen .....	149	Knochenraspel, PUTTI .....	294	Kürette, HOUSE .....	420
KLEINERT-KUTZ, Hohlmeißel .....	237	Knochenraspel, PUTTI .....	294		
KLEINERT-KUTZ, Sehnenfaßinstrument .....	294	Knochenraspel, PUTTI .....	294	L	
KLEINSASSER, Bruststütze .....	36	Knochenraspel, PUTTI .....	294	LA FORCE, Fremdkörpernadel .....	374
KLEINSASSER, Fiberglas-Lichtträger .....	36	Knochenraspel, PUTTI .....	294	LA FORCE, Ringmesser .....	450
KLEINSASSER, Injektionskanüle .....	36	Knochenraspel, PUTTI .....	294	LA GRANGE, Zahnfleischschere .....	69
KLEINSASSER, Rauchabsaugrohr .....	36	Knochenraspel, PUTTI .....	294	LA GRANGE, Supercutschere .....	72
KLEINSCHMIDT, Blinddarmklemme .....	544	Knochenraspel, PUTTI .....	294	LABORE, Trachealdilatator .....	476
Klemme, Vasektomie .....	553/2	Knochenraspel, PUTTI .....	294	LACRIMAL, Augenkanüle .....	394
Klemmenhalterung, DE MARTEL-WOLFSON .....	546	Knochenraspel, PUTTI .....	294	Ladekonus f. RUDD .....	568
Klemmschleißzange, DE MARTEL-WOLFSON .....	546	Knochenraspel, PUTTI .....	294	LAHEY, Arterienklemme .....	120
Klemmschloß, STONE-WATT .....	545	Knochenraspel, PUTTI .....	294	LAHEY, Kropfpaßzange .....	479
Klemmsockel .....	189	Knochenraspel, PUTTI .....	294	LAHEY, Wundhaken .....	157
Klinge .....	49	Knochenraspel, PUTTI .....	294	LAMBERT, Chalazionspinzette .....	393
Klingen-Skalpell .....	42	Knochenraspel, PUTTI .....	294	LAMBERT-KAY, Anastomosenklemme .....	505
Klingenbrecher, CASTROVIEJO .....	45	Knochenraspel, PUTTI .....	294	LAMBERT-LOWMAN, Knochenhalteklammer .....	249
Klingenbrecher, REDA .....	45	Knochenraspel, PUTTI .....	294	LAMBOTTE, Knochenhaltezange .....	244
Klingenbrecher, TROUTMAN-CHRIS .....	45	Knochenraspel, PUTTI .....	294	LAMBOTTE, Osteotom .....	261
Klingentferner .....	42	Knochenraspel, PUTTI .....	294	LAMBOTTE, Raspator .....	274
KLINIKUM BERLIN, Schlauchklemme .....	129	Knochenraspel, PUTTI .....	294	Laminektomie-Zange, SPURLING .....	340
KLINKENBERGH-LOTH, Gefäßschere .....	65/2	Knochenraspel, PUTTI .....	294	Laminektomie-Zange, CUSHING .....	340
KNAPP, Irismesser .....	372	Knochenraspel, PUTTI .....	294	Laminektomie-Zange, LOVE-GRUENWALD .....	340
KNAPP, Irisschere .....	55	Knochenraspel, PUTTI .....	294	Laminektomie-Zange, LOVE-GRUENWALD .....	340
KNAPP, Stariöffel .....	378	Knochenraspel, PUTTI .....	294	Laminektomie-Spreizer, CHERRY .....	488
KNAPP, Tränensackhäkchen .....	375	Knochenraspel, PUTTI .....	294	Laminektomie-Spreizer, CASPAR .....	179, 180
KNAPP-LUER, Trachompinzette .....	393	Knochenraspel, PUTTI .....	294	Laminektomie-Spreizer, MEYERDING .....	180
KNIGHT, Septumzange .....	425	Knochenraspel, PUTTI .....	294	Laminektomie-Spreizer, SCOVILLE .....	196
Knochendraht .....	314	Knochenraspel, PUTTI .....	294	Laminektomie-Spreizer, SCOVILLE-HAVERFIELD .....	196
Biegeisen, BENDER .....	322	Knochenraspel, PUTTI .....	294	Laminektomie-Zange, CLOWARD .....	342
Knochenfeile .....	294, 612/1	Knochenraspel, PUTTI .....	294	Laminektomie-Zange, FERRIS-SMITH .....	343
Knochenhaken, VOLKMANN .....	156	Knochenraspel, PUTTI .....	294	Laminektomie-Zange, OLDBERG .....	341
Knochenhalteklammer, LAMBERT-LOWMAN .....	249	Knochenraspel, PUTTI .....	294	Laminektomie-Zange, SCHLESINGER .....	342
Knochenhalteklammer, FELDHEIM .....	249	Knochenraspel, PUTTI .....	294	Laminektomie-Zange, WAGNER .....	343
Knochenhalteklammer, GERSTER .....	250	Knochenraspel, PUTTI .....	294	LANCASTER, Lidsperrer .....	371
Knochenhalteklammer, LOWMAN .....	249	Knochenraspel, PUTTI .....	294	LANDAU, Scheidenspekula .....	577
Knochenhalteklammer, LOWMAN-HOGLUND .....	249	Knochenraspel, PUTTI .....	294	LANDOLT, Tumorfaßzange .....	341
Knochenhaltezange .....	245, 247, 249	Knochenraspel, PUTTI .....	294	LANE, Biegehebel .....	325
Knochenhaltezange, BIRCHER-GANSKE .....	246	Knochenraspel, PUTTI .....	294	LANE, chirurgische Pinzette .....	84
Knochenhaltezange, MARTIN .....	246	Knochenraspel, PUTTI .....	294	LANE, Knochenhaltezange .....	244
Knochenhaltezange, PATELLA .....	248	Knochenraspel, PUTTI .....	294	LANE, Knochenhebel .....	290
Knochenhaltezange, REDA .....	246, 247	Knochenraspel, PUTTI .....	294	LANE, Knochenplatten-Haltezange .....	325
Knochenhaltezange, DINGMANN .....	246	Knochenraspel, PUTTI .....	294	LANE, Kreuzschlitz-Schraubenzieher .....	324
Knochenhaltezange, FARABEUF .....	243	Knochenraspel, PUTTI .....	294	LANE, Magenquetschklemme .....	547
Knochenhaltezange, FARABEUF-LAMBOTTE .....	243	Knochenraspel, PUTTI .....	294	LANE, Schraubenzieher .....	325
Knochenhaltezange, FERGUSON .....	243	Knochenraspel, PUTTI .....	294	LANE, Schraubenzieher .....	323
Knochenhaltezange, KERN .....	244	Knochenraspel, PUTTI .....	294	LANE-TRETHOWAN, Knochenhebel .....	290
Knochenhaltezange, LAMBOTTE .....	244	Knochenraspel, PUTTI .....	294	LANE, Tuchklemme .....	133
Knochenhaltezange, LANE .....	244	Knochenraspel, PUTTI .....	294	LANG, Tränensack-Dissektor .....	378
Knochenhaltezange, LANGENBECK .....	243	Knochenraspel, PUTTI .....	294	LANGE, Aufsatz .....	472
Knochenhaltezange, LEWIN .....	246	Knochenraspel, PUTTI .....	294	LANGE, Nasenflügelhäkchen .....	448
Knochenhaltezange, REILL .....	248	Knochenraspel, PUTTI .....	294	LANGE-HOHMANN, Knochenhebel .....	286
Knochenhaltezange, SEMB .....	243	Knochenraspel, PUTTI .....	294	LANGENBECK, Amputationsmesser .....	44
Knochenhaltezange, ULRICH .....	248	Knochenraspel, PUTTI .....	294	LANGENBECK, Fingersäge .....	296
Knochenhaltezange, VAN BUREN .....	249	Knochenraspel, PUTTI .....	294	LANGENBECK, Fingerschützer .....	311
Knochenhaltezange, VERBRUGGE .....	245	Knochenraspel, PUTTI .....	294	LANGENBECK, Knochenhaltezange .....	243
Knochenhebel .....	282 - 286/2, 288	Knochenraspel, PUTTI .....	294	LANGENBECK, Knorpelmesser .....	47
Knochenhebel, AUFRANC-COBRA .....	289	Knochenraspel, PUTTI .....	294	LANGENBECK, Nadelhalter .....	213
Knochenhebel, LANGE-HOHMANN .....	286	Knochenraspel, PUTTI .....	294	LANGENBECK, Ohrschlinge .....	409
Knochenhebel, VERBRUGGE-MÜLLER .....	287	Knochenraspel, PUTTI .....	294	LANGENBECK, Raspator .....	275
Knochenhebel, BENNETT .....	283	Knochenraspel, PUTTI .....	294	LANGENBECK, Wundhaken .....	158, 159
		Knochenraspel, PUTTI .....	294	LANGENBECK-GREEN, Wundhaken .....	153

LANZENMESSER, JAEGER.....	372	LISTON, Amputationsmesser.....	44	MASING, Nasenhaken.....	447
LÄRMTROMMEL, BARANY.....	405	LISTON, Knochensplitterzange.....	241	MASSING-NEIVERT, Nasenhaken.....	447
LARSEN, Sehnenfußpinzette.....	292	LITTAUER, Cilienpinzette.....	395	MASSON, Nadelhalter.....	210
LARYNGOSKOP-Kaltlichtgriff, Batteriegriff.....	33	LITTAUER, Fadenschere.....	66	Maßstab, Metall.....	25
LARYNGOSKOP-Warmlicht, Batteriegriff.....	32	LITTAUER, Ohrzängchen.....	411	Mastdarm-Biopsiezange, TURREL.....	567
LARYNGOSKOP-Warmlichtgriff mit Trafo-Anschluß.....	34	LITTAUER, Polypenzange.....	425	Mastdarm-Biopsiezange, YEOMAN.....	566, 567
LARYNGOSKOP, HOLINGER.....	37	LITTLE, Wundhaken.....	157	Mastdarm-Spekula, ALAN-PARKS.....	561
LARYNGOSKOP, JACKSON.....	37	LITTLER, Irisschere.....	55	Mastdarm-Spekula, BARR.....	559
LARYNGOSKOP, MILLER.....	30	LITTLEWOOD, Darmfaßzange.....	538	Mastdarm-Spekula, BODENHAMMER.....	559
LATERALSPREIZER.....	569	LOCKHART-MUMMERY, Fistelsonde.....	200	Mastdarm-Spekula, CZERNY.....	559
LAWRENCE, Arterienklemme.....	119	LOCKLIN, Zahnfleischschere.....	69	Mastdarm-Spekula, MATHIEU.....	560
LEBSCHKE, Sternummeißel.....	267	LOCKWOOD-ALLIS, Darmfaßzange.....	538	Mastdarm-Spekula, PRATT.....	559
LEES, Bronchusklemme.....	504	Löffelzängchen.....	416	Mastdarm-Spekula, SIMS.....	559
LEGUE, Blasenwundspreizer.....	553	LONDON-COLLEGE, Zahnpinzette.....	93	Mastdarm-Spekula, SCHULZE-BERGMANN.....	560
LEGUEU, Blasenpatel.....	552	LOPEZ-REINKE, Tonsillen-Dissektor.....	465	MASTIN, Muskelklemme.....	479
LEKSELL (STILLE), Hohlmeißelzange.....	240	LORENZ, Verbandschere.....	70	MATHIEU, Fremdkörperzange.....	553/1
LELAND-JONES, Gefäßklemme.....	494	LORNA, Tuchklemme.....	133	MATHIEU, Mastdarmspekula.....	560
LEMPERT, Elevator.....	420	LOUTE, Drahtspanninstrument.....	315	MATHIEU, Nadelhalter.....	213
LEMPERT, Hohlmeißelzange.....	237	LOVE, Nervwurzelhaken.....	329/2, 330	MATHIEU, Wundhaken.....	141
LEMPERT, scharfer Löffel.....	256	LOVE, Wundhaken.....	465	MATHIEU-OLSEN, Nadelhalter.....	212
LERICHE, Faßpinzette.....	83	LOVE-GRUENWALD, Laminektomiezange.....	340	MATSON, Raspator.....	279
LERICHE, Arterienklemme.....	111	LOVELACE, Arterienklemme.....	109	MATSON-ALEXANDER, Raspator.....	279
LERICHE, Bauchspatel.....	143/2	LOVELACE, Lungenfaßzange.....	490	MAUNDER, Mundkeil.....	459
LERICHE, Darmspatel.....	143/2	LOWER, Arterienklemme.....	120	MAXI-GRASPER, Uterus-Biopsiezange.....	593
LESTER, Fixationspinzette.....	389	LOWMAN, Knochenhalteklammer.....	249	MAYFIELD, Hohlmeißelzange.....	238
LEVINSON, Fremdkörpernadel.....	374	LOWMAN-HOGLUND, Knochenhalteklammer.....	249	MAYO, Gallensteinlöf­fel.....	534
LEWIN, Knochenhalte­zange.....	246	LUBET-BARBON, Nasentamponzange.....	424	MAYO, Gallensein­sonde.....	534
LEWIS, Nasenraspel.....	443	LUC, Septumzange.....	426	MAYO, Pinzette.....	89
LEXER-BABY, Präparierschere.....	53	LUCAE, Hähchen.....	409	MAYO, Präparierschere.....	52
LEXER, Flachmeißel.....	263	LUCAE, Hammer.....	271	MAYO, Sterilisierklammer.....	227, 624
LEXER, Hohlmeißel.....	263	LUCAE, Ohrpinzette.....	410	MAYO, Supercuttschere.....	71
LEXER-Mini, Hohlmeißel.....	263	LUCAE, Parazentese-Nadel.....	408	MAYO, Zungenspatel.....	451
LEXER, Präparierschere.....	53	LUCAE, Stimm­gabel.....	404	MAYO-ADAMS, Wundspreizer.....	171
LEYLA, Retraktor-System.....	368	LUER, Hohlmeißelzange.....	236	MAYO-BLAKE, Gallensteinzange.....	531
LICHTENBERG, Nadelhalter.....	213	LUER, Trachealkanüle.....	479	MAYO-COLLINS, Wundhaken.....	141
LICHTLEITERKABEL-SIEBKORB.....	623	LUER, Wundhaken.....	140	MAYO-HABERISSER, Drahtzange.....	319
LICHTTRÄGER.....	37	LUER-KOERTE, Gallensteinlöf­fel.....	533	MAYO-HEGAR, Nadelhalter.....	209
LICHTTRÄGER, JACKSON.....	37	Luftdusche, POLITZER.....	406	MAYON-GUYON, Arterienklemme.....	122
LICHTTRÄGER, HOLLINGER.....	37	Luftpumpe.....	295	MAYO-NOBLE, Präparierschere.....	52
LICHTWITZ, Kieferhöhlentrokar.....	204	LUIKART, Geburtszange.....	603	MAY, Ophtalmoskop UNI II.....	14
LICHTWITZ, Punktionskanüle.....	433	LUIKART-BILL, Zughebel.....	604	MAYO-ROBSON, Darmklemme.....	541
LIDPLATTE, JAEGER.....	371	Lungenfaßzange, LOVELACE.....	490	MAYO-STILLE, Präparierschere.....	52
LIDSPERRER, BARRAQUER.....	370	Lungenschere, CRAFOORD.....	65/2	MAYO-STILLE, Supercuttschere.....	71
LIDSPERRER, BOWMAN.....	370	Lungenspatel.....	489	MC DONALD, Elevator.....	283
LIDSPERRER, CLARK.....	370	Lungenspatel, ALLISON.....	489	McGIVNEY, Hämorrhoidal-Ligatur.....	568
LIDSPERRER, CRITCHETT.....	370	LUNGSSGAARD, Sklerotom.....	373	McGIVNEY, Hämorrhoidal-Zange.....	568
LIDSPERRER, MURDOCK.....	370	LUNIATSCHEK, Tamponstopfer.....	465	McINDOE, Knochensplitterzange.....	241
LIDSPERRER, SMITH.....	370	Lupuskürette, FOX.....	608	McKENZIE, Bohrer.....	299
LIDSPERRER, ARRUGA.....	370	Lupuskürette, PIFFARD.....	608	McCULLOUGH, Strabismus­pinzette.....	385
LIDSPERRER, CASTROVIEJO.....	371	M.....		McGEE, Hähchen.....	419
LIDSPERRER, GRAEFE.....	370	Magen-Darmnähapparat, PETZ.....	549	McGEE, Mikro-Ohrzängchen.....	414
LIDSPERRER, LANCASTER.....	371	Magen-Darmklemme, MIKULICZ.....	543	McINDOE, Knorpelschere.....	65/1
LIDSPERRER, LIEBERMAN.....	371	Magenquetschklemme, LANE.....	547	McINDOE, Pinzette.....	85
LIDSPERRER, LISTER-BURCH.....	370	MAGILL, Katheterzange.....	28	McINTYRE, Augenkanüle.....	394
LIDSPERRER, MELLINGER.....	370	MAGIER, Kornzange.....	134	McIVOR, Mundsperrerr.....	457
LIDSPERRER, MELLINGER-AXENFELD.....	370	MALTZ (COTTLE), Nasenraspel.....	444	McKENRY, Septum­elevator.....	437, 438
LIDSPERRER, MUELLER.....	371	MALTZ, Nasenraspel.....	443	McKENZIE, Anlegezange.....	326
LIDSPERRER, PARK.....	371	Mandrin f. RUMEL-BELMONT.....	528	McLEAN, Geburtszange.....	603
LIDSPERRER, STEVENSON.....	371	Manometer.....	295	McLEAN-LUIKART, Geburtszange.....	603
LIDSPERRER, WEEK.....	370	Manometer f. SCHULTZE.....	596	McLEAN-TUCKER, Geburtszange.....	603
LIDSPERRER, WILLIAMS.....	370	Markierungsinstrument, CONNIN-AMSLER.....	380	McLEAN-TUCKER-LUIKART, Geburtszange.....	603
LIDSPERRER, ZIEGLER.....	371	Markraumborner.....	322	McPHERSON, Fadenpinzette.....	392
LIEBERMAN, Lidsperrerr.....	371	MARQUARD, Hohlmeißelzange.....	239	MEAD, Hammer.....	271
LIGATUR-GUMMIRINGE f. MC GIVNEY.....	568	MARSSCHIK, Tonsillenfaßpinzette.....	468	MEAD, Hohlmeißelzange.....	235
LIGATURKLEMMEN, DeBAKEY.....	499, 500	MARTEL, Faßzange.....	110	Medizinbecher.....	621
LINSENHAKEN, STEVENS.....	375	MARTIN, Beckenzirkel.....	605	Medizinlöf­fel.....	268, 621
LINSENMANIPULATOR, BECHERT.....	379	MARTIN, Cartilageschere.....	65/1	MEEKER, Arterienklemme.....	119
LIPPENHALTER.....	453, 451	MARTIN, Knochenhalte­zange.....	246	MEHDORN, Anlegepinzette.....	362
LIPPENHALTER, CAWOOD-MINNESOTA.....	451	MARTIN, Uterussonde.....	586	MEHDORN, Gefäßclip.....	362
LISTER (SINUS), Tupferzange.....	137	MARTIN, Verbindungskabel.....	633	Mehrzweck-Gefäßklemme.....	520
LISTER, Verbindungs­schere.....	72	MARTIN, Wundspreizer.....	175/1	Mehrzweck-Gefäßklemme, BAINBRIDGE.....	495
LISTER, Verbandschere.....	69/1	MARTINI, scharfer Löffel.....	257	Mehrzweck-Gefäßklemme, GLOVER.....	515, 518, 519
LISTER-BURCH, Lidsperrerr.....	370			Mehrzweck-Gefäßklemme, DeBAKEY.....	495, 508, 514 - 517

Mehrweckschale.....	620	MILLIN, Prostatafaßzange.....	550, 551	Nabelschnurschere, MOD. USA.....	64
Meißel, BRUNETTI.....	268	Mini-Bulldogklemme, DeBAKEY-DIETRICH.....	101	Nabelschnurschere, SCHUMACHER.....	64
Meißelklinge.....	266	Mini-Schnellkupplungshandgriff.....	301	Nadel, BARBARA.....	419
MELLINGER, Lidsperrer.....	370	Mini-Skalpell.....	41	Nadel, ROSEN.....	419
MELLINGER-AXENFELD, Lidsperrer.....	370	Mini-Skalpellgriffe.....	41	Nadel, REVERDIN.....	220
MENGHINI, Biopsiekanüle.....	206	Mini-Bulldogklemme, DIETRICH.....	101	Nadel, YOUNG-BOOMERANG.....	220
Meniskusuhaken, BLOUNT.....	289	Mini-Bulldogklemmen, DeBAKEY-DIETRICH.....	101	Nadellose.....	615
Meniskussmesser, NEFF.....	292	MINI-LAMBOTTE, Flachmeißel.....	262	Nadelelektrode, monopolar.....	628, 629
Meniskussmesser, SMILLIE.....	292	MINI-TOWNSEND-DOWN, Biopsiezange.....	591	Nadelführer, IOWA.....	206
MERCEDES, Thoraxsperrer.....	489	MINI-TOWNSEND-UP, Biopsiezange.....	591	Nadelhalter, BARRAQUER.....	216, 217
MERIAM, Zahnpinzette.....	93	MIXTER, Arterienklemme S-gebogen.....	116	Nadelhalter, BARRAQUER-TROUTMAN.....	216
Meßbecher.....	620	MIXTER, Gallensteinzange.....	531	Nadelhalter, MICROVASCULAR.....	210
Messer, Amputation.....	44	MIXTER-BABY, Arterienklemme.....	119/1	Nadelhalter, ADSON.....	211
Messer, Zwischenknochen.....	44	MIXTER-O-SHAUGNESSY, Arterienklemme.....	119/2	Nadelhalter, ARRUGA.....	214
Messer, PLESTER.....	418	Mobilisierhaken, TESSIER.....	463/3	Nadelhalter, BABY-WEBSTER.....	208
Messer, ROSEN.....	418	MOD. BONN, Nahtpinzette.....	387	Nadelhalter, BAUMGARTNER.....	208
Messer, SCHUKNECHT.....	418	MOD. TÜBINGEN, Fadenpinzette.....	392	Nadelhalter, BOYNTON.....	214
Messer, TABB.....	418	MOD. TÜBINGEN, Nahtpinzette.....	387	Nadelhalter, BOZEMANN.....	211
Messer, WULLSTEIN.....	418	MOD. MÜNCHEN, Biopsiekurette.....	587	Nadelhalter, BROWN.....	209
Meißgerät, IWANSON.....	624	MOD. VIENNA, Nasenspekula.....	421	Nadelhalter, CASTROVIEJO.....	215, 216
Meißinstrumente.....	594	MOELTGEN, Winkelmesser.....	25	Nadelhalter, CASTROVIEJO-Micro.....	215
Meißschieber.....	26	MOGEN, Beschneidungsgerät.....	556	Nadelhalter, CASTROVIEJO-Standard.....	216
Meißsonde, HOUSE.....	420	MOLLISON, Wundspreizer.....	171	Nadelhalter, COLLIER.....	208
Messzirkel, CASTROVIEJO.....	380	MOLT, Rasatorium.....	276	Nadelhalter, CRILE.....	213
Metalkatheter.....	555	Monopolare Elektrode.....	629	Nadelhalter, CRILE-MURRAY.....	209
Metalkatheter, COXETER.....	555	MOOR, Gallensteinlöffel.....	532	Nadelhalter, CRILE-WOOD.....	209
METZENBAUM, chirurgische Schere S.....	54	MOORE, Handbohrapparat.....	298	Nadelhalter, DE BAKEY.....	210
METZENBAUM FINO, Präparierschere TC.....	53	MOORFIELD, Nahtpinzette.....	392	Nadelhalter, DERF.....	208
METZENBAUM, Nadelhalter.....	211	MORGAN, Proktoskop.....	565	Nadelhalter, FINOCHIETTO.....	211
METZENBAUM, Präparierschere.....	53/1	MORITZ-SCHMIDT, Zungenspatel.....	452	Nadelhalter, GILLIES.....	212
METZENBAUM, Supercutschere.....	71	MORRIS, Wundhaken.....	164	Nadelhalter, HALSEY.....	208
METZENBAUM, Präparierschere TC.....	53/1	MORRIS-DeBAKEY, Aortaklemme.....	506	Nadelhalter, HEANEY.....	210
MEYERDING, Laminektomiespreizer.....	180	MORSE, Rippenspreizer.....	484	Nadelhalter, HOESEL.....	213
MEYERDING, Wundhaken.....	157, 177	MORSE-FAVALORO, Rippenspreizer.....	484	Nadelhalter, JACOBSON.....	215
MEYERDING, Wundspreizer.....	180	MOYNIHAN, Arterienklemme.....	120	Nadelhalter, JOHNSON.....	211
MEYHOEFER, Chalzationskurette.....	377	MOYNIHAN, Gallensteinsonde.....	532	Nadelhalter, KALT.....	214
MICHEL, Kehlkopfspiegel.....	423	MOYNIHAN, Tuckklemme.....	133	Nadelhalter, KALT-ARRUGA.....	214
MICHEL, Wundklammern.....	224	MUELLER, Lidsperrer.....	371	Nadelhalter, KILNER.....	212
MICHEL, Wundklammerpinzette.....	224	Mukosamesser, FREER.....	434	Nadelhalter, LANGENBECK.....	213
MICHEL, Wundklammerzange.....	224	MÜLLER, Approximator.....	364	Nadelhalter, LICHTENBERG.....	213
Micro-FRIEDMANN, Hohlmeißelzange.....	234	MÜLLER, Gefäßclip.....	365	Nadelhalter, MASSON.....	210
Micro-HARTMANN, Arterienklemme.....	104	Mundkeil, MAUNDER.....	459	Nadelhalter, MATHIEU.....	213
MICROVASCULAR, Nadelhalter.....	210	Mundsperrer, DAVIS-MEYER.....	457	Nadelhalter, MATHIEU-OLSEN.....	212
MIDDELDRORF, Wundhaken.....	160	Mundsperrer, DAVIS-BOYLE.....	455	Nadelhalter, MAYO-HEGAR.....	209
MIDDLETON-JANSEN, Septumzange.....	430	Mundsperrer, DENHART.....	454	Nadelhalter, METZENBAUM.....	211
mikro-chirurgische Pinzette.....	94	Mundsperrer, DINGMANN.....	456	Nadelhalter, NEIVERT.....	208
mikro-chirurgische Pinzette, GOMEL.....	96	Mundsperrer, HEISTER.....	454	Nadelhalter, OLSEN-HEGAR.....	212
Mikro-Faßzängchen, Rohrschaft.....	415	Mundsperrer, JENNINGS.....	454	Nadelhalter, RYDER.....	210
Mikro-Kanüle f. ZÖLLNER und WULLSTEIN Sauggriff.....	337/1	Mundsperrer, KILNER-DOUGHTY.....	456	Nadelhalter, SAROT.....	211
Mikro-Löffelzängchen, WULLSTEIN.....	416	Mundsperrer, McIVOR.....	457	Nadelhalter, STEVENS.....	214
Mikro-Löffelzängchen, Rohrschaft.....	416	Mundsperrer, ROSER-KOENIG.....	454	Nadelhalter, WANGENSTEEN.....	210
Mikro-Meßsonde, HOUSE.....	420	Mundsperrer, DOYEN-JANSEN (MOLT).....	454	Nadelhalter, WEBSTER.....	208
Mikro-Ohrscherchen, BELLUCCI.....	413, 417	MURDOCK, Lidsperrer.....	370	Nadelhalter, BABY-OLSEN-HEGAR.....	212
Mikro-Ohrscherche, SHEA.....	413	MURPHY, Wundhaken.....	156	Nadelhalter, STRATTE.....	212
Mikro-Ohrzängchen.....	413 - 416	MURPHY-LANE, Elevator.....	283	Nadeln, chirurgische.....	222
Mikro-Ohrzängchen, COS.....	414	MUSEUX, Hakenzange.....	583	NAEGELE, Geburtszange.....	622
Mikro-Ohrzängchen, DIETER.....	414	Muskelhaken.....	267	Nagelausreißzange, RADOLF.....	297
Mikro-Ohrzängchen, GREVEN.....	414	Muskelklemme, MASTIN.....	479	Nagelfeile.....	610
Mikro-Ohrzängchen, HAUGH.....	414	Muskelpinzette, TROUTMAN.....	389	Nagelhautzange.....	610, 613
Mikro-Ohrzängchen, JUERS.....	414	Muskelpinzette, BERKE.....	389	Nagelscheren.....	609, 614
Mikro-Ohrzängchen, McGEE.....	414	Muskelpinzette, PRINCE.....	387	Nagel-Set.....	609
Mikro-Rohrschaftzange REDA.....	474	Muskelpinzette, SNELLEN.....	393	Nagelspaltzange, ANVIL.....	613
Mikro-Schere, GOMEL.....	80	Mutterschlüssel.....	313	Nagelsplitterinstrument.....	612/1
Mikro-Schere, HEPP-SCHEIDEL.....	78	MYLES, Nasenzange.....	427	Nagelzange, TURNBULL.....	609
MIKULICZ, Darmklemme.....	543	Myomheber, DOYEN.....	594	Nagelzangen.....	609, 612/2, 613, 614
MIKULICZ, Peritoneumklemme.....	123	Myommesser, SEGOND.....	594	NAGER, Tonsillennadel.....	466
MIKULICZ, Wundhaken.....	163	Myrtenblattsonde.....	199	NAGER, Wundhaken.....	465
MIKULICZ-BABY, Peritoneumklemme.....	123	N		Nahtpinzette, CASTROVIEJO.....	392
MILLER, Laryngoskop.....	30	NABATOFF, Krampfaderbesteck.....	201	Nahtpinzette, MOD. BONN.....	387
MILLER, Nasenraspel.....	444	Nabelschnurklemme, COLLIN.....	605	Nahtpinzette, MOD. TUEBINGEN.....	387
MILLIGAN, Dura-Dissektor.....	332	Nabelschnurklemme, KANE.....	605	Nahtpinzette, MOORFIELD.....	392
MILLIN, Blasenperrer.....	552, 553	Nabelschnurschere, BUSCH.....	64	Nahtpinzette, St. MARTIN.....	392
MILLIN, Kapselnahtpinzette.....	550, 551			Nasenflügelhäkchen, LANGE.....	448

Nasenhaken, CONVERSE	448	Neuro-chirurgische Schere	65	Opthalmoskop, MAY UNI II	14
Nasenhaken, AUFRICHT	447	Neuro-chirurgische Schere, STRULLY	65	OP-Laryngoskop, KLEINSASSER	35
Nasenhaken, COTTLE	447, 447/1	NEWS, Trachealhaken	477	OP-Laryngoskop, HOLINGER	37
Nasenhaken, FOMON	447/1	Nierenklemme, GUYON	122	OP-Laryngoskop, JACKSON	37
Nasenhaken, KILNER	447/1	Nierenschale	619	Organmesser	48
Nasenhaken, MASING	447	Nierensteinzange, HEIMING	536	Organ- und Gewebefalzange, atrauma	111
Nasenhaken, MASING-NEWERT	447	Nierensteinzange, RANDALL	535	osillierende Gipssäge	230
Nasennaessel, WEST	442/1	Nierensteinklemme, HERRICK	123	osillierende Gipssäge mit Stababsauger	231
Nasennaesser, FREER	434	Nierenstiellklemme, WERTHEIM-CULLEN	125	Osteotom, MINI-LAMBOTTE	262
Nasennaesser, JOSEPH	434, 435	NISSEN, Arterienklemme	113	Osteotom, LAMBOTTE	261
Nasennaesser, CONVERSE	435	NORFOLK/NORWICH, Wundspreizer	172	Osteotom, OBWEGESER	463, 464/1
Nasennaesser, COTTLE	435	NORTHBENT, Fadenschere	66	Osteotom, SMITH-PETERSEN	261
Nasennolive, POLITZER	406	NOTO, Uterus-Polypenzange	585	Osteotome	259, 464
Nasenzinnette, JANSEN	424	NOVAK, Biopsiekürette	587	Osteotome, EPKER	464/2
Nasenzinnette, JANSEN-GRUENWALD	424	NOVOTEX, Hohlmeißel	264	Osteotome, HIBBS	265
Nasenzinnette, TROELTSCH	424	NOYES, Augenschere	75	Osteotome, LEXER	263
Nasenzinnette, AUFRICHT	443	NOYES, Polypenzange	425	Osteotome, COTTLE	440
Nasenzinnette, MILLER	444	Nystagmusbrille, FRENZEL	20	Osteotome, HOKE	265
Nasenzinnette, PEET	446	O		Osteotome, STILLE	260
Nasenzinnette, FOMON	444	Obduktions-Besteck	269	Osteotomklinge	266
Nasenzinnette, JOSEPH	443	Oberarmmanschette	295	OSTROEM, Knochenstanze	430
Nasenzinnette, JOSEPH (LEWIS)	443	Oberschenkelmanschette	295	O'SULLIVAN-O'CONNOR, Bauchdeckenhalter	181
Nasenzinnette, LEWIS	443	OBWEGESER, Ahle	463, 463/3	O'SULLIVAN-O'CONNOR, Scheidenspekula	576
Nasenzinnette, MALTZ	443	OBWEGESER, Blattosteotom	464/1	OTIS, Urethrotom	553
Nasenzinnette, MALTZ (COTTLE)	444	OBWEGESER, Osteotom	463, 464/1	Otoskop Diagnostik-Besteck, UNI I	13
Nasenzinnette, WIENER	443	OBWEGESER, Raspator	462	OVERHOLT, Arterienklemme	114
Nasensäge, JOSEPH	446	OBWEGESER, Wundhaken	460, 461	OVERHOLT-BABY, Arterienklemme	114
Nasenschere	59	OCHSNER, Trokar	205	OVERHOLT-GEISENDOERFER, Arterienklemme	114
Nasenschere, COTTLE	59	O'CONNOR, Iriskäpfchen	375	OVERHOLT-MIXTER, Arterienklemme	115
Nasenschere, FOMON	58	OEHLE, chirurgische Pinzette	81/1	P	
Nasenschere, HEYMANN	58	Ohrhebel, ZAUFAL	409	Parametrium-Schere	63
Nasenspekula, COTTLE	423	Ohrhebel, ZAUFAL-JANSEN	409	Parazentese-Nadel, LUCAE	408
Nasenspekula, HARTMANN	422	Ohrkatheter, HARTMANN	408	Parazentese-Nadel, POLITZER	408
Nasenspekula, HARTMANN-HALLE	421	Ohrkürette, BUCK	407	PARK, Lidsperrer	371
Nasenspekula, KILLIAN	423	Ohrküvette, GROSS	409	PARKER, Wundhaken	139
Nasenspekula, MOD.VIENNA	421	Ohrmesser, POLITZER	408	PARKER-LANGENBECK, Wundhaken	141
Nasenspekula, REDA	423	Ohrmesser, SEXTON	408	PARTSCH, Flachmeißel	259
Nasenspekula, THUDICHUM	421	Ohrpinzette JANSEN	424	PARTSCH, Hammer	271
Nasenspekula, TIECK-HALLE	423	Ohrpinzette JANSEN-GRUENWALD	424	PARTSCH, Hohlmeißel	259
Nasenspekula, VOLTOLINI	421	Ohrpinzette TROELTSCH	424	PASSOW, Blutstillungsmeißel	260
Nasentamponzange, LUBET-BARBON	424	Ohrpinzette, LUCAE	410	PATELLA, Knochenhalte-zange	248
Nasentamponzange, WESTMACOTT	424	Ohrpinzette, TROELTSCH	410	PATON, Hornhautdissektor	373
Nasenzange, CAPLAN	428	Ohrpinzette, WILDE (TROELTSCH)	410	PAUFIQUE, Fadenpinzette	392
Nasenzange, HARTMANN	427	Ohrschlinge, BILLEAU	409	PAUFIQUE, Keratoplastik-Messer	373
Nasenzange, MYLES	427	Ohrschlinge, LANGENBECK	409	PAYR, Darmquetschklemme	548
Nasenzange, SCHMEDEN	427	Ohrschlinge, SHAPLEIGH	410	PAYR, Führungshohlsonde	221
Nasenzange, TAKAHASHI	427	Ohrsonde, STACKE	199	PAYR-BABY, Darmquetschklemme	548
Nasenzange, WATSON-WILLIAMS	428	Ohrspekula, RICHNAU-HOLMGREN	400	PEAN, Arterienklemme	108, 110
Nasenzange, WEIL-BLAKESLEY	426	Ohrspekula, BOUCHERON	399	PECK-JOSEPH Präparierschere	74
Nasenzange, STRUYCKEN	427	Ohrspekula, BRUENINGS	401	PEDERSON, Scheidenspekula	570
NEFF, Meniskusmesser	292	Ohrspekula, GRUBER	399	PENFIELD, Dissektor	333
NEGUS, Bruststütze	459	Ohrspekula, HARTMANN	399	PEERS, Tuckklemme	132
NEGUS, Tonsillenzange	467	Ohrspekula, POLITZER	399	PEET, Nasenraspel	446
NEIVERT, Nadelhalter	208	Ohrspekula, SIEGLE	402	PEET, Splitterzange	92
NEIVERT-ANDERSON, Septummeißel	442	Ohrspekula, TOYNBEE	399	PELKMANN, Tupferzange	137
NELATON, Hohlsonde	199	Ohrspekulahalter, LEYLA	368/3	Pelvis-Haken, St. MARKS	165
NELSON, Gefäßpinzette	89	Ohrspritze, REINER	406	Penisklemme, STOCKMANN	553/1
NELSON, Trokar	205	Ohrzängchen, HARTMANN	411	Penisklemme, STRAUSS	553/1
NELSON, Unterbindungs-nadel	219	Ohrzängchen, LITTAUER	411	PENNINGTON, Arterienklemme	109
NEONATAL, Atraumaklemme	523	Ohrzängchen, TILLEY	411	PENNINGTON, Septum-elevator	438
Neonatal-Gefäßklemme, CASTANEDA	527	OLDBERG, Laminektomie-Zange	341	PERCY, Retraktor	296
Nerven-haken, CUSHING	328	OLIVECRONA, Drahtsäge	332	Perforatorie, SMELLIE	607
Nervhäkchen, KRAYENBUEHL	336	OLIVECRONA, Dura-Dissektor	332	Peripheral-Gefäßklemme, DeBAKEY	494
Nervhaken, CRILE	328	OLIVECRONA, Hirnspatel	336	Peripheral-Gefäßklemme, LELAND-JONES	494
Nervhaken, DANDY	328	OLIVECRONA, Hohlmeißelzange	237	Peritoneumklemme, FAURE	123
Nervhaken, GRAHAM	329	OLIVECRONA-TOENNIS, Anlegezange	326	Peritoneumklemme, MIKULICZ	123
Nervhaken, SACHS	329	OLLIER, Wundhaken	162	Peritoneumklemme, PHANEUF	123
Nervhaken, SMITHWICK	329	OLSEN-HEGAR, Nadelhalter	212	PERKINS, Wundspreizer	168
Nervhäkchen, WARTENBERG	25	OMBREDANNE, Hammer	273	Perkussionshammer, BABINSKY	24
Nervwurzelhaken, D'ERRICO	329/2	Opthalmologie-Schere, GRADLE	57	Perkussionshammer, BERLINER	24
Nervwurzelhaken, HESS	329/1	Opthalmologie-Schere, AEBLI	58	Perkussionshammer, BUCK	24
Nervwurzelhaken, LOVE	329/2, 330	Opthalmologie-Schere, STEVENS	58	Perkussionshammer, TAYLOR	24
Nervwurzelhaken, SCOVILLE	329/1, 330				

Perkussionshammer, TROEMNER .....	24	Präparierschere, TOENNIS-ADSON.....	65	Raspator, OBWEGESER.....	462
PERTHES, Pfiem .....	304	Präparierschere, METZENBAUM FINO TC.....	53/1	Raspator, QUERVAIN.....	275
PESTALOZZA, Abortuskürette .....	606	Präparierschere, PECK-JOSEPH .....	74	Raspator, SEBILEAU.....	275
PETRI, Box .....	620	Präparierschere, MAYO-NOBLE.....	52	Raspator, SEDILLOT .....	274, 275
PETZ, Magen- und Darmnähapparat .....	549	PRATT, Dilator.....	580	Raspator, SELDIN.....	277
Pfiem .....	304	PRATT, Faßzange .....	110	Raspator, SEMB .....	278
Pfiem, PERTHES .....	304	PRATT, Fistelsonde.....	563	Raspator, WILLIGER.....	276
Phalagenmesser .....	44	PRATT, Hakenzange.....	584	Rasporatorium, MOLT .....	276
PHANEUF, Peritoneumklemme .....	123	PRATT, Mastdarm-Spekula .....	559	Rauchabsaugrohr, KLEINSASSER.....	36
PIERCE, Kieferhöhlentroktr .....	204	PRATT, Uterus-Dilatator .....	580	RECAMIER, Uteruskürette .....	597, 598
PIERCE, Septum elevator .....	438	PRECISA, Blutdruckmeßgerät.....	9	Recordspritze .....	596
PIFFARD, Lupuskürette .....	608	PRESBYTERIAN, Schlauchklemme .....	129	REDA, Amputationsmesser .....	44
PILLING, Clipanlegezange .....	524, 525	PRICE-THOMAS, Bronchusklemme .....	490	REDA, Augenmangnet .....	395
PINARD, Stethoskop .....	23	PRINCE, Muskelpinzette .....	387	REDA, Cilienpinzette .....	395
Pinzette, anatomisch.....	81	PRINCE, Tonsillenschere .....	59	REDA EXCENTER, Verbandschere .....	69/2
Pinzette, bipolar .....	630-632	PROBE AND PACKER .....	612	REDA, Fadengabel .....	221
Pinzette, BONNEY.....	88	Profundaklemme, GREGORY .....	517	REDA, Fingerringssäge .....	297
Pinzette, DeBAKEY.....	98	Proktoskop, BENSAUDE .....	565	REDA, Gipsspreizer .....	232
Pinzette, JACKSON.....	471	Proktoskop, MORGAN .....	565	REDA, Handbohrapparat .....	300
Pinzette, MAYO .....	89	Proktoskop, CHELSEA-EATON .....	563	REDA, Hauthäkchen.....	150
Pinzette, STRASSBURGER MODELL .....	89	Proktoskop, FANSLER .....	564	REDA, Kappenzange .....	615
Pinzette, Uhrmacher.....	90	Proktoskop, HIRSCHMANN .....	563	REDA, Klängenbrecher .....	45
Pinzette, ULTRA-LIGHT.....	95	Proktoskop, IVES-FANSLER .....	563	REDA, Knochenhalte zange .....	246, 247
Pinzette, WAGENSTEEN .....	89	Proktoskop, KELLY .....	563, 564	REDA, Mikro-Rohrschaftzange .....	474
Pinzette, DAVIS .....	227	Prostatafaßzange, MILLIN.....	550, 551	REDA, Nasenspekulum .....	423
Pinzette, GOMEL .....	96	Prostatahaken, YOUNG .....	550	REDA, Organ- u. Gewebefaßzange, atrauma .....	111
Pinzette, YASARGIL .....	97	PROVIDENCE-HOSPITAL, Arterienklemme .....	106	REDA, scharfer Löffel .....	256
PIPER, Geburtszange.....	604	Pulverbläser, KABIERSKA .....	405	REDA, Sichelmesser .....	435
Pistole f. Reinigung .....	626	Pulverbläser, UNIVERSAL .....	405	REDA, Watteträger .....	203
Plastik-Hammer .....	271	Pumpe f. Komprimeter .....	295	REDON, Führungsnadel .....	207
Plazentabecken .....	621	Punktionskanüle, FRAZIER .....	337	REES, Face-Lift-Schere .....	73
PLESTER, Messer .....	418	Punktionskanüle, LICHTWITZ .....	433	Reibahele .....	304
PLESTER, Saugrohr .....	338	PUTTI, Knochenraspel .....	294	REICHERT, Kehildeckelhalter .....	471
PLESTER, Wundspreizer .....	171	Pylorus spreizer, BENSON.....	544	REILL, Knochenhalte zange .....	248
POLITZER, Gummibirne .....	406	Q .....		REINER, Gipsmesser.....	233
POLITZER, Luftdusche .....	406	QUERVAIN, Elevator .....	275	REINER, Ohrspritze .....	406
POLITZER, Nasenolive .....	406	QUINBY, Zahnfleischschere .....	67	Reinigungsaußsatz .....	626
POLITZER, Ohnmesser .....	408	QUIRE, Fremdkörperhebel .....	412	Reinigungs pistole .....	626
POLITZER, Ohrspekula .....	399	QUISLING, Hammer .....	271	Rektal-Absaugrohr, BUJE.....	566
POLITZER, Parazentese-Nadel .....	408	R .....		Rektal-Schnürer, WESTON.....	566
Polster f. Oberarm- u. Oberschenkelmanschette .....	295	Rachiotom .....	267	Rektal-Spekulum, SAWYER .....	560
Polypenschlinge .....	411	RADOLF, Nagel ausreißzange .....	297	Rektal-Spekulum, HILL-FERGUSON .....	560
Polypenschnürer, KRAUSE-VOSS .....	433/2	RAHMF, Nagel ausreißzange .....	297	Rektum-Anastosenklemme, HAYES .....	545
Polypenschnürer, KRAUSE .....	411, 433/2	Rahmen f. DENIS-BROWNE, Bauchdeckenhalter .....	185	Repositionszange, ROWE .....	459
Polypenschnürer, WILDE .....	411, 433/2	Rahmen f. KIRSCHNER, Bauchdeckenhalter 185, 187, 187/1 .....	185	RESANO, Darmklemme .....	542
Polypenzange, HEYMANN-KNIGHT .....	425	Rahmen f. O'SULLIVAN-O'CONNOR .....	576	RESANO, Kapselschere .....	53/2
Polypenzange, HARTMANN .....	424	RALK, Handbohrapparat .....	300	Resektionsmesser .....	47
Polypenzange, LITTAUER .....	425	RAMPLEY, Tupferzange.....	136	Retraktor, PERCY .....	296
Polypenzange, NOYES.....	425	RAMUS, Wundhaken.....	461	Retraktoren, Intraoral .....	463/1, 463/4
POOLE, Saugrohr .....	27	RANDALL, Biopsiekürette .....	587	Retraktor-System, LEYLA.....	368-368/4
POST MORTEM .....	269	RANDALL, Nierensteinzange.....	535	REVERDIN, Darmspatel .....	143/1
POTTS, Gefäßklemme .....	492, 493	RANEY, Klammeranlegezange .....	327	REVERDIN, Nadel.....	220
POTTS, Anastomosen-Klemme .....	493	RANEY, Kopfhautklammern .....	327	REYNOLDS, chirurgische Schere .....	54
POTTS, Coarctations-Klemme .....	492	RANGELL, Wundhaken .....	140	REYNOLDS, Supercutschere .....	72
POTTS-SMITH, chirurgische Pinzette .....	81	Rasierklängen .....	45	Rhinoplastikschere, FOMON.....	65/1
POTTS-DE MARTEL, Gefäßschere .....	59	Rasiermesser .....	49	RIBBON, Darmspatel .....	143
POTTS-SMITH, anatomische Pinzette .....	81	Raspator .....	279	RICARD, Bauchdeckenhalter .....	191
POTTS-SMITH, Gefäßschere .....	61	Raspator, ADSON.....	282	RICHARDSON, Wundhaken .....	142
Präparierschere .....	52	Raspator, ALEXANDER .....	276	RICHARDSON-EASTMAN, Wundhaken .....	142
Präparierschere, DEAVER .....	52	Raspator, COBB .....	280	RICHARDSON-GRIP, Wundhaken .....	142
Präparierschere, MAYO .....	52	Raspator, DINGMANN .....	463, 463/3	RICHNAU-HOLMGREN, Ohrspekula .....	400
Präparierschere, MAYO-TC .....	52	Raspator, DOYEN.....	278	RICHTER-HEATH, Wundklammerzange .....	224
Präparierschere, MAYO-STILLE .....	52	Raspator, FARABEUF .....	274	RIENHOFF-FINOCHIETTO, Rippenspreizer .....	486
Präparierschere, MAYO-STILLE TC .....	52	Raspator, FARABEUF-COLLIN .....	274	RIGBY, Bauchdeckenhalter .....	189/2
Präparierschere, METZENBAUM .....	53/1	Raspator, FOMON .....	277	Rt-MINI, Diagnostik-Besteck .....	17
Präparierschere, METZENBAUM FINO.....	53/1	Raspator, HARGIS.....	463/2	RING, Zungenspatel.....	455
Präparierschere, METZENBAUM TC .....	53/1	Raspator, JOSEPH .....	277	Ringmesser, BECKMANN .....	450
Präparierschere, WELLER.....	53/2	Raspator, KOENIG.....	276	Ringmesser, BARNHILL .....	450
Präparierschere, JORGENSEN.....	53	Raspator, LAMBOTTE .....	274	Ringmesser, LA FORCE .....	450
Präparierschere, LEXER .....	53	Raspator, LANGENBECK .....	275	Ringmesser, St. CLAIR-THOMSON .....	450
Präparierschere, LEXER-BABY .....	53	Raspator, MATSON .....	279	Rippenkontraktor, BAILEY.....	489
Präparierschere, LEXER-BABY TC .....	53	Raspator, MATSON-ALEXANDER .....	279	Rippenkontraktor, BAILEY-BABY .....	489
Präparierschere, METZENBAUM .....	53/1			Rippenkontraktor, BAILEY-GIBBON .....	489



Rippenschere, SAUERBRUCH-FREY .....	481	SAUERBRUCH, Abfallzange .....	227	Scheidenspekula, SCHERBAK .....	575
Rippenschere, BETHUNE .....	481	SAUERBRUCH, Hohlmeißelzange .....	240	SCHEIE, Goniotomiemesser .....	373
Rippenschere, BRUNNER .....	481	SAUERBRUCH, Rippenschere .....	481	SCHEIMMANN, Aufsatz .....	472
Rippenschere, CORYLLOS .....	480	SAUERBRUCH, Wundhaken .....	164, 166	SCHERBAK, Scheidenspekula .....	575
Rippenschere, GIERTZ-STILLE .....	481	SAUERBRUCH-FREY, Rippenschere .....	481	Schere, GORNEY .....	73
Rippenschere, GLUCK .....	480	Sauggriff, WULLSTEIN .....	338	Schere, MIKRO .....	76
Rippenschere, SAUERBRUCH .....	481	Saugraspatorium, GUILLEN .....	433/1	Schere, Neurochirurgie .....	65
Rippenschere, STILLE .....	480	Saugrohr .....	337/1	Schere, PARAMETRIUM .....	63
Rippensperrer, COOLEY .....	485, 487	Saugrohr, FERGUSSON .....	337	Schere, REES .....	73
Rippensperrer, COOLEY-NEONATAL .....	485	Saugrohr, ZÖLLNER .....	337/1	Schere, WAGNER .....	67
Rippensperrer, DE BOER .....	486	Saugrohr, ADSON .....	337	Schere, CASTROVIEJO .....	79
Rippensperrer, FINOCHIETTO .....	482, 484	Saugrohr, ANDREW-PYNCHON .....	28	Schere, DOYEN .....	63
Rippensperrer, FINOCHIETTO-BABY .....	482	Saugrohr, BABY-YANKAUER .....	27	Schere, HEPPE-SCHUIDEL .....	78
Rippensperrer, FINOCHIETTO-BURFORD .....	483	Saugrohr, BARON .....	336	Schere, SIEBOLD .....	62
Rippensperrer, HAIGHT .....	487	Saugrohr, COOLEY .....	28	Schere, SIMS .....	62
Rippensperrer, MORSE .....	484	Saugrohr, DeBAKEY .....	28	Schere, THOREK .....	65/2
Rippensperrer, MORSE-FAVALORO .....	484	Saugrohr, FRAZIER/FERGUSSON .....	337	Schieblehre, TOWNLEY .....	26
Rippensperrer, RIENHOFF-FINOCHIETTO .....	486	Saugrohr, PLESTER .....	338	Schielhaken, GRAEFE .....	375
Rippensperrer, TUFFIER .....	487	Saugrohr, POOLE .....	27	Schielhaken, JAMESON .....	375
RITTER-HALLE, Stirnhöhle dilatator .....	433	Saugrohr, ROSEN .....	338	Schildrüsenhaken, SCHOENBORN .....	479
ROBB, Gefäßdissektor .....	530	Saugrohr, YANKAUER .....	27	SCHIMMELBUSCH, Verbandstofftrommel .....	622
ROBB, Spatel .....	530	Saugrohr, YASARGIL .....	337/1	SCHINK, Dermatome .....	49
ROBERTS, Arterienklemme .....	117	Saugrohre, HOUSE .....	337/2	SCHIOETZ, Tonometer .....	394/2
ROCHARD, Bauchdeckenhalter .....	186	SAWTELL, Tonsillenzange .....	467	Schlauchhalterung .....	188
ROCHARD, Fixiervorrichtung .....	186	SAWYER, Rektal-Spekulum .....	560	Schlauchklemme, KLINIKUM BERLIN .....	129
ROCHESTER-CARMALT, Arterienklemme .....	109	SAYRE, Elevator .....	281	Schlauchklemme, PRESBYTERIAN .....	129
ROCHESTER-OCHSNER, Arterienklemme .....	108	SCAGLIETTI, Hohlmeißelzange .....	240	Schlauchklemme, HOFFMANN .....	624
ROCHESTER-PEAN, Arterienklemme .....	108	SCALP-CONTOUR, Wundspreizer .....	169	Schlauchklemme, SIMPLEX .....	624
ROEDER, Tuchklemme .....	132	Schädelhalter, CRUTCHFIELD .....	327	Schlauchklemme, BÜLOW-GUNAR-HEY .....	130
ROGER, Septumlevator .....	437	Schädelspalter .....	267	Schlauchklemmen .....	129
ROGERS, Hysterektomieklammer .....	127	Schädelstanze, CONE .....	331	Schlauchverbindungsstück .....	600
ROGGE, Sterilisierzange .....	227	SCHAEDEL, Tuchklemme .....	132	SCHLESINGER, Laminektomiezange .....	342
ROLLET, Extirpationsmeißel .....	374	Schädelzange, DeVILBISS .....	332	Schließklemme, STONE .....	545
ROLLET, Tränensackhäkchen .....	375	Schaft .....	231/3	Schlinge f. Polypenschürer .....	433/2
ROSE, Wundhaken .....	140	Schale .....	619	Schlüssel f. Meißel .....	266
ROSEN, Messer .....	418	Schälmesser, Tracheotomie .....	475	Schlüssel f. Osteotome .....	266
ROSEN, Nadel .....	419	SCHAMBERG, Komedonenquetscher .....	608	Schlüsselpaar f. Gipssäge und Autopsiesäge .....	230, 231/3
ROSEN, Saugrohr .....	338	Scharfer Löffel .....	255	SCHMEDEN, Nasenzange .....	427
ROSER-KOENIG, Mundsperrer .....	454	Scharfer Löffel, BRUNS .....	251, 254	SCHMID, Gefäß- u. Spülkanüle .....	338
ROUX MINI, Wundhaken .....	140	Scharfer Löffel, BUSHE .....	256	SCHMIEDEN, Führungshohlsonde .....	221
ROUX, Wundhaken .....	139	Scharfer Löffel, COBB .....	252	SCHMIEDEN-DICK, Unterbindungsadel .....	219
ROUX-BABY, Wundhaken .....	140	Scharfer Löffel, DAUBENSPECK .....	255	SCHMIEDEN-TAYLOR, Duraschere .....	65/1
ROWE, Repositionszange .....	459	Scharfer Löffel, HALLE .....	253	Schnellkupplungs-T-Handgriff .....	300, 301
RUBIN, Septummeißel .....	440	Scharfer Löffel, JACOBSON .....	257	Schnellkupplungs-Handgriff .....	301
RUBIN, Septumzange .....	428	Scharfer Löffel, JANSEN .....	257	SCHNIDT, Tonsillenzange .....	467
RUDD, Hämorrhoidal-Ligator .....	568	Scharfer Löffel, LEMPERT .....	256	SCHOENBORN, Schilddrüsenhaken .....	479
RUMEL, Arterienklemme .....	117	Scharfer Löffel, MARTINI .....	257	Schraubenhaltehülse .....	324
RUMEL-BELMONT, Tourniquet .....	528	Scharfer Löffel, REDA .....	256	Schraubenhaltezeuge, LANE .....	325
RUSKIN, Hohlmeißelzange .....	239	Scharfer Löffel, SCHEDE .....	251	Schraubenzieher m. Ferrozellgriff .....	323
RUSKIN-LISTON, Knochensplitterzange .....	241	Scharfer Löffel, SCOVILLE .....	253	Schraubenzieher, WILLIAMS .....	323
RUSSEL-DAVIS, Zungenspatel .....	458	Scharfer Löffel, SPINAL .....	253	Schraubenzieher, LANE .....	323
RUSSISCHES MODELL, Fußpinzette .....	85	Scharfer Löffel, SPRATT .....	251	SCHRÖDER, Hakenzange .....	584
RYDEL-SEIFFERT, Stimmgabel .....	404	Scharfer Löffel, VOLKMANN .....	257	SCHRÖDER, Uteruslöffel .....	595
RYDER, Nadelhalter .....	210	Scharfer Löffel, WILLIGER .....	255, 257	SCHROEDER (POZZI), Hakenzange .....	582
		SCHUDE, scharfer Löffel .....	251	SCHROEDER, Hakenzange .....	583
S		Scheidenspekula .....	569 - 577	SCHUBERT, Biopsiezange .....	588
SAALFELD, Komedonenquetscher .....	608	Scheidenspekula, JACKSON .....	573	SCHUKNECHT, Messer .....	418
SACHS, Dura-Dissektor .....	332	Scheidenspekula, AUVARD .....	576	SCHULTZE, Salpingograph .....	596
SACHS, Nervhaken .....	329	Scheidenspekula, BREISKY .....	577	SCHULZE-BERGMANN, Mastdarm-Spekula .....	560
SAENGER, Abortuszange .....	606	Scheidenspekula, COLLIN .....	570	SCHUMACHER, Aufsatz .....	472
Säge, GIGLI .....	332	Scheidenspekula, CUSCO .....	570, 571	SCHUMACHER, Biopsiezange .....	588
Sägeblatt f. Fingerringssäge .....	297	Scheidenspekula, DELEE .....	574	SCHUMACHER, Episotomieschere .....	64
Sägeblätter .....	230	Scheidenspekula, DOYEN .....	574	SCHUMACHER, Sternumschere .....	481
Sagittalspreizer, SMITH .....	463/5	Scheidenspekula, GRAVE .....	570	SCHUMACHER, Uterus-Biopsiezange .....	589
Salpingograph, SCHULTZE .....	596	Scheidenspekula, KALLMORGAN .....	573	Schlüssel .....	619
SANVENERO, chirurgische Schere .....	54	Scheidenspekula, KRISTELLER .....	572	SCHWEIGGER, Kapselpinzette .....	391
SAROT, Arterienklemme .....	118	Scheidenspekula, LANDAU .....	577	Schwingmesser, BALLENGER .....	436
SAROT, Nadelhalter .....	211	Scheidenspekula, O'SULLIVAN-O'CONNOR .....	576	SCOVILLE, Haken .....	196
SATINSKY, Gefäßklemme .....	491	Scheidenspekula, PEDERSON .....	570	SCOVILLE, Laminektomiespreizer .....	196
SATINSKY, Gefäßschere .....	65/2	Scheidenspekula, SEMM .....	571	SCOVILLE, Nervwurzelhaken .....	329/1, 330
SATINSKY, Tangentialklemme .....	502	Scheidenspekula, SIMS .....	573	SCOVILLE, scharfer Löffel .....	253
SATO, Hornhautmesser .....	373	Scheidenspekula, TRELAT .....	571	SCOVILLE-HAVERFIELD, Laminektomiespreizer .....	196
SATTERLEE, Amputationssäge .....	296	Scheidenspekula, VU-MORE .....	569	SCUDDER, Darmklemme .....	541

SEBILLEAU, Raspator.....	275	SHAMBAUGH, Hackchen.....	419	Sonde, HARMS.....	381
SEDLLOT, Raspator.....	274, 275	SHAPLEIGH, Ohrschlinge.....	410	Sonde, MARTIN.....	586
Segmentsage.....	231/2	SHEA, Mikro-Ohrschere.....	413	Sonde, SIMS.....	586
SEGOND, Hysterektomieklammer.....	125	SHEEHAN, Osteotom.....	441	Sonde, WATSON-CHEYNE.....	199
SEGOND, Myomesser.....	594	SHEEHAN, Septummeiel.....	441	Sonde, WORST.....	381
SEGOND-LANDAU, Hysterektomieklammer.....	125	SHEETS, Augenkanule.....	394/2	Sonden.....	199
Sehnenfainstrument, BRAND.....	293	Sichelmesser, REDA.....	435	Sondenspitzen f. NABATOFF.....	201
Sehnenfainstrument, CAROLL.....	293	Sichelmesser, Tracheotomie.....	475	Spannarml, flexibel, LEYLA.....	368/3
Sehnenfainstrument, KLEINERT-KUTZ.....	294	SIEBENMANN, Spulkanule.....	433/1	Spannplatte.....	49
Sehnenfapinzette, LARSEN.....	292	Siebkorb fur Endoskope u. Lichtleiterkabel.....	623	Spannschlussel.....	313
Sehnenfazange.....	293	Siebkorbdeckel.....	623	Spatel.....	203, 612/1
Sehnenfazange, JACKSON.....	292	SIEBOLD, gynakologische Schere.....	62	Spatel, ROBB.....	530
Sehnenfuhrer, BUNELL.....	294	Siebschale, perforiertes Blech.....	623	SPATULA AND PACKER.....	612
Sehnenhaltezange, STEINMANN.....	292	SIEGLE, Ohrspekula.....	402	Spekula, FRIEDMANN.....	577
Sehenschaler, BRAND.....	294	Silberklammern.....	326	Spekula, KALLMORGEN.....	573
Sehenschaler, BUNNELL.....	292	Siilikoneinlage f. DAVIS-BOYLE.....	455	Spekula, KRISTELLER.....	572
SEIFERT, Aufsatz.....	472	Siikonmatte.....	616	SPENCER, Fadenschere.....	66
Sektionsnadel.....	268	Siikon Schlauch f. McIVOR.....	457	SPENCER-WELLS, Arterienklammer.....	109
SELDIN, Raspator.....	277	SILVER, Dermatom.....	50	Sperrer, DAVIS-BOYLE.....	455
SELECT, Verbindungskabel.....	633	SILVER, Septummeiel.....	442	Sperrer, DINGMANN.....	456
SELLHEIM, Geburtsoffel.....	607	SIMCOE, Spulkanule.....	394/2	Sperrer, KILNER-DOUGHTY.....	456
SEMB, Bronchusklammer.....	491	SIMON, Uterusoffel.....	594	Spinalhaken, TAYLOR.....	291
SEMB, Hohlmeielzange.....	240	SIMON, Wundhaken.....	164	SPINAL, scharfer Loffel.....	253
SEMB, Knochenhaltezange.....	243	SIMPLEX, Schlauchklammer.....	624	SPINA-NASALIS, Wundhaken.....	461
SEMB, Knochen splitterzange.....	242	SIMPSON, Geburtszange.....	602	Spiralbohrer.....	302
SEMB, Raspator.....	278	SIMPSON-BRAUN, Geburtszange.....	602	Spitze f. YANKAUER Saugrohr.....	27
SEMKEN, anatomische Pinzette.....	86	SIMPSON-LUIKART, Geburtszange.....	603	Splitterpinzette.....	91
SEMKEN, chirurgische Pinzette.....	86	SIMS, gynakologische Schere.....	62	Splitterpinzette, CARMALT.....	91
SEMM, Scheidenspekula.....	571	SIMS, Mastdarm-Spekula.....	559	Splitterpinzette, FEILCHENFELD.....	91
SENN-GREEN, Wundhaken.....	153	SIMS, Scheidenspekula.....	573	Splitterpinzette, HUNTER.....	91
SENN-MILLER, Wundhaken.....	143	SIMS, Sonde.....	586	Splitterzange, ARCHER.....	92
Septenzange, KNIGHT.....	425	SIMS, Uterus-Dilatator.....	581	Splitterzange, PEET.....	92
Septenzange, HEYMANN.....	425	SIMS, Uterus-Depressor.....	586	Splitterzange, VIRTUS (RALK).....	92
Septumhohlmeiel, FREER.....	442/1	SIMS, Uteruskurrette.....	597, 598	Splitterzange, STIEGLITZ.....	92
Septumhohlmeiel, HAJEK.....	442/1	SIMS, Uterussonde.....	586	SPRATT, scharfer Loffel.....	251
Septumhohlmeiel, KILLIAN-CLAUS.....	442/1	SIMS-MAIER, Kornzange.....	134	Spreizer, SMITH.....	463/5
Septumosteotom, SHEEHAN.....	441	SINGLEY, Gewebefapinzette.....	88	Spritzen.....	407
Septumosteotome, CINELLI.....	441	SINOSKOPIE-TROKAR.....	205	Spul- u. Saugkanule, BISHOP-HARMON.....	394/1
Septumosteotome, FOMON.....	441	SINSKEY, Hackchen.....	376	Spulkanule, KILLIAN.....	433, 433/1
Septumelevator, FREER.....	437, 439	SINUS, Septumelevator.....	438	Spulkanule, EICKEN (KILLIAN).....	433
Septumelevator, HOWARTH.....	438	Sinuskopie-Zange.....	431	Spulkanule, HARTMANN.....	433
Septumelevator, McKENTY.....	437, 438	Skalpelle Mini.....	41	Spulkanule, SIEBENMANN.....	433/1
Septumelevator, BALLENGER.....	439	Skalpelle mit Metallheft.....	46	Spulkanule, SIMCOE.....	394/2
Septumelevator, COTTLE.....	439	Skalpelle, steril.....	43	SPURLING, Laminektomiezange.....	340
Septumelevator, COTTLE-JOSEPH.....	439	Skalpellgriff.....	38 - 42	Sputumbecher.....	621
Septumelevator, HAJEK-BALLENGER.....	439	Skalpellgriff Mini.....	41	St. CLAIR-THOMSON, Ringmesser.....	450
Septumelevator, HALLE.....	437	Skalpelliklingen.....	42	St. MARKS-PELVIS, Haken.....	165
Septumelevator, JOSEPH.....	437	Skalpelliklingen-Entferner.....	42	St. MARKS, Wundhaken.....	165
Septumelevator, KILLIAN.....	438, 439	SKENE, Hakenzange.....	582	St. MARTIN, Nahtpinzette.....	392
Septumelevator, PENNINGTON.....	438	Sklerotom, GUYTON-LUNDSSGAARD.....	373	STACKE, Ohrsonde.....	199
Septumelevator, PIERCE.....	438	Sklerotom, LUNDSSGAARD.....	373	STAMM, Knochen splitterzange.....	241
Septumelevator, ROGER.....	437	SLS, Clipanlagezange.....	524, 525	Standard, chirurgische Schere.....	51
Septumelevator, SINUS.....	438	SLUDER-BALLENGER, Tonsillotom.....	470	STANDARD (NELSON), Trokar.....	204
Septummeiel, CINELLI.....	441	SMELLIE, Haken.....	605	Standgefa.....	620
Septummeiel, COTTLE.....	440	SMELLIE, Perforatorie.....	607	Stanze, COLCLOUGH.....	344/1
Septummeiel, FOMON.....	441	SMILIE, Meniskusmesser.....	292	Stanze, FERRIS-SMITH-KERRISON.....	344
Septummeiel, FREER.....	439	SMILLIE, Knochenhebel.....	291	Stanze, OSTROEM.....	430
Septummeiel, NEIVERT-ANDERSON.....	442	SMITH, Lidsperrer.....	370	Stanze, CITELLI.....	430
Septummeiel, RUBIN.....	440	SMITH, Sagittalspreizer.....	463/5	Stanze, HAJEK-KOFLER.....	429, 431
Septummeiel, SHEEHAN.....	441	SMITH, Spreizer.....	463/5	Stanze, KERRISON.....	428
Septummeiel, SILVER.....	442	SMITH US ARMY, Verbandschere.....	69/1	Staroffel, DAVIEL.....	377
Septumrichtzange, ASCH.....	449	SMITH-BUIE, Analspreizer.....	561	Staroffel, GRAEFE.....	377
Septumrichtzange, WALSHAM.....	449	SMITH-PETERSEN, Hohlmeiel.....	261	Staroffel, KNAPP.....	378
Septumschere, KILLIAN.....	471	SMITH-PETERSEN, Hohlmeielzange.....	238	Starmesser, DEUTSCHMANN.....	371
Septumzange, BRUENINGS.....	425	SMITH-PETERSEN, Osteotom.....	261	Starmesser, GRAEFE.....	371
Septumzange, GRAIG.....	426	SMITHWICK, Anlegezange.....	326	starrer Haltearm, LEYLA.....	368/1
Septumzange, LUC.....	426	SMITHWICK, Nervhaken.....	329	Starschlinge, ARLT.....	378
Septumzange, MIDDLETON-JANSEN.....	430	SNELLEN, Muskelpinzette.....	393	Starschlinge, SNELLEN.....	378
Septumzange, RUBIN.....	428	SNELLEN, Starschlinge.....	378	Starschlinge, WEBER.....	378
SERPENTINE-GRASPER, Fazange, flexibel.....	593	SOMER, Uterus-Fazange.....	585	Starschlinge, WILDER.....	378
SEUTIN, Verbandschere.....	69/2	Sonde VALLEIX.....	586	Stativ.....	188
SEXTON, Ohrmesser.....	408	Sonde, COLLIN.....	586	Staubinde, ESMARCH.....	296
Seziermesser, VIRCHOW.....	48	Sonde, FISH.....	199	STAUDE-MOORE, Hakenzange.....	582

Stechbecken.....	621	Supercutschere, FREEMAN .....	74	Titan-Arterienklemme, KELLY .....	106
STEINMANN, Endernagel .....	307, 308	Supercutschere, GORNEY .....	73	Titan-Pinzette, DeBAKEY, atrauma .....	99
STEINMANN, Knochenagel.....	307, 308	Supercutschere, IRIS.....	72	Titan-Bulldogklemme, atrauma .....	102
STEINMANN, Sehenhaltezeuge .....	292	Supercutschere, KAYE .....	73	TOBOLD, Watterträger .....	203
STELLBRINK, Hohlmeißelzange .....	234	Supercutschere, KILNER .....	72	TOBOLD, Zungendrucker.....	453
sterile Ersatzlinge .....	50	Supercutschere, LISTER .....	72	TOENNIS, Arterienklemme .....	117
sterile Skalpelle .....	43	Supercutschere, MAYO .....	71	TOENNIS, Dura-Dissektor .....	332
sterile Skalpell-Klingen .....	42	Supercutschere, MAYO-STILLE.....	71	TOENNIS-ADSON, Schere .....	65
Sterilisierbehälter .....	616	Supercutschere, METZENBAUM .....	71	TOHUKU, Tuchklemme .....	132
Sterilisierkasten .....	616, 618	Supercutschere, REES .....	73	Tonometer, SCHIOETZ.....	394/2
Sterilisierkammer, BUNT .....	227, 624	Supercutschere, REYNOLDS .....	72	Tonsillennadel, CLAUS .....	466
Sterilisierkammer, MAYO .....	227, 624	Supercutschere, STEVENS .....	72	Tonsillennadel, CLAUS-EICKEN .....	466
Sterilisiersiebsschale .....	622	Supercutschere, WAGNER.....	72	Tonsillennadel, DUPUY-WEISS .....	466
Sterilisierzange .....	227	Supercutschere, BABY METZENBAUM .....	71	Tonsillennadel, NAGER.....	466
Sterilisierzange, CHEATLE .....	227	SWEET, Anlegezange .....	326	Tonsillendissektor, HURD .....	465
Sterilisierzange, ROGGE .....	227	SYSTRUNK, chirurgische Schere .....	66	Tonsillendissektor, LOPEZ-REINKE .....	465
Sterilisierzange, UNIVERSAL .....	227	T .....		Tonsillendissektor, YANKAUER .....	465
STERNBERG, Wangenhalter .....	453	TABB, Messer.....	418	Tonsillendraht .....	468
Sternnummeißel, LEBSCHE .....	267, 480	Tablett .....	620	Tonsillenelevator, CARPENTER .....	465
Sternumschere, SCHUMACHER.....	481	Tablettenschale .....	621	Tonsillenelevator, HENKE .....	465
Stethoskop, ANESTOPHON .....	23	TAKAHASHI, Nasenzange .....	427	Tonsillennadel, MARSCHIK .....	468
Stethoskop, DUPLEX .....	23	Tamponstopfer, LUNIATSCHKEK .....	465	Tonsillennadel, ABRAHAM .....	468
Stethoskop, PINARD .....	23	Tamponzange, BOZEMANN .....	138	Tonsillennadel, COLVER.....	467
STEVENS, Irispinzette .....	383	Tamponzange, BOZEMANN-DOUGLAS .....	138	Tonsillennadel, ABRAHAM .....	466
STEVENS, Linsenhaken .....	375	Tangentialklemme, DeBAKEY .....	502	Tonsillennadel, CARPENTER .....	466
STEVENS, Nadelhalter .....	214	Tangentialklemme, DeBAKEY-SATINSKY .....	502	Tonsillennadel, CANFIELD .....	466
STEVENS, Ophthalmologie-Schere .....	58	Tangentialklemme, SATINSKY .....	502	Tonsillennadel, CARPENTER .....	465
STEVENS, Supercutschere .....	72	TARNIER, Geburtszange .....	604	Tonsillennadel, DOUGLAS .....	466
STEVENSON, Lidsperrerr .....	371	TARNIER, Kranioclast .....	607	Tonsillennadel, FISHER .....	466
STIEGLITZ, Splitterzange .....	92	Taschenbesteck .....	225, 226	Tonsillennadel .....	470
STILLE, anatomische Pinzette .....	81	TAYLOR, chirurgische Pinzette .....	87	Tonsillenschere .....	59
STILLE, Arterienklemme .....	122	TAYLOR, Haken .....	196	Tonsillenschere, BOETTCHER .....	59
STILLE, chirurgische Pinzette .....	81/1	TAYLOR, Perkussionshammer .....	24	Tonsillenschere, DEAN .....	59
STILLE, Flachmeißel .....	260	TAYLOR, Spinalhaken .....	291	Tonsillenschere, GOOD .....	59
STILLE, Gipschere .....	229	TC chirurgische Schere fein, REYNOLDS .....	54	Tonsillenschere, PRINCE .....	59
STILLE, Handbohrapparat .....	298	TC chirurgische Schere, STANDARD .....	51	Tonsillenschneider, TYDING .....	469
STILLE, Hohlmeißel .....	260	TC Nasenraspel, FOMON .....	445	Tonsillenschneider, BRUENINGS .....	468
STILLE, Osteotom .....	260	TC Pinzette, chirurgisch .....	81/1	Tonsillenschneider, EVES .....	468
STILLE, Rippenschere .....	480	TC Pinzette, CUSHING .....	83	Tonsillenspritze .....	470
STILLE-BARRAYA, Gefäßpinzette .....	88	TC Pinzette, GILLIES .....	86	Tonsillenzange, BALLENGER .....	467
STILLE-HORSLEY, Knochensplitterzange .....	242	TC Pinzette, SEMKEN .....	86	Tonsillenzange, BLOHMKE .....	467
STILLE-LISTON, Knochensplitterzange .....	242	TC Pinzette, WAGENSTEEN .....	89	Tonsillenzange, NEGUS .....	467
STILLE-LUER, Hohlmeißelzange .....	239	TC Pinzette, anatomisch .....	81	Tonsillenzange, SAWTELL .....	467
STILLE-RUSKIN, Hohlmeißelzange .....	239	TC Schere, FREEMAN .....	74	Tonsillenzange, SCHMIDT .....	467
STILLE-SHERMAN, Handbohrapparat .....	298	TC Schere, PECK-JOSEPH .....	74	Tonsillenzange, TYDING .....	468
Stimmgabel, HARTMANN .....	403	TC Schere, REES .....	73	Tonsillenzange, WHITE .....	467
Stimmgabel, LUCAE.....	404	TC Schere, GORNEY .....	73	Tonsillotom, SLUDER-BALLENGER .....	470
Stimmgabeln .....	403, 404	TC Schere, KAYE.....	73	Tonsillotom, TYDING .....	469
Stimmgabeln, RYDEL-SEIFFERT .....	404	TEALE, Hakenzange .....	583	TOOK, Hornhautmesser .....	373
Stirnhöhle dilatator, RITTER-HALLE .....	433	TEBBETTS, Wundhaken .....	197	Tourniquet, RUMEL-BELMONT .....	528
Stirnlampe, CLAR .....	22	Teleskop-Bohrdrahtstütze .....	299	TOWNLEY, Schieblehre .....	26
Stirnspiegel, ZIEGLER .....	21	TERSON, Kapsel-pinzette .....	391	TOWNSEND, Uterus-Biopsiezange .....	591
STOCKMANN, Penisklemme .....	553/1	TESSIER, Haken .....	463/3	TOYNBEE, Ohrspekula .....	399
STONE, Schließklemme .....	545	TESSIER, Mobilisierhaken .....	463/3	Trachealhaken, BOSE .....	477
STONE-WATT, Darmklemme .....	545	T-Handgriff, HUDSON .....	300	Trachealdilatator, TROUSSEAU-BABY .....	476
STONE-WATT, Klemmschloß .....	545	T-Handgriff, Schnellkupplung .....	300, 301	Trachealdilatator, LABORDE .....	476
Stößel .....	258, 259	THOMAS, Uteruskürette .....	599	Trachealdilatator, TROUSSEAU .....	476
Stößel, CASPAR .....	258	THOMAS-GAYLOR, Biopsiezange .....	588	Trachealhaken, ITERSON .....	477
STRABISMUS, Schere .....	58	THOMAS-ALLIS, Darmaßzange .....	538	Trachealhaken, JACKSON .....	476
Strabismuspinzette, BONACCOLTO .....	385	THOMSON-WALKER, Blasenwundsperrerr .....	552	Trachealhaken, NEWS .....	477
Strabismuspinzette, DASTOOR .....	386	Thoraspserrerr, MERCEDES .....	489	Trachealkanüle, CHEVALIER-JACKSON .....	479
Strabismuspinzette, JAMESON .....	385	THOREK, Gallenblasenschere .....	65/2	Trachealkanüle, LUER .....	479
Strabismuspinzette, McCULLOUGH .....	385	THUDICHUM, Nasenspekula .....	421	Trachealkanüle, WAGENER-MOSHER .....	477
STRANDELL-STILLE, Wundhaken .....	157	TIECK-HALLE, Nasenspekula .....	423	Trachealwundsperrerr, BOSE .....	476
STRASSBURGER, Pinzette .....	89	Tiefen-Messinstrument .....	594	Tracheotomie-Besteck .....	478
STRATTE, Nadelhalter .....	212	Tiefensäge .....	231/2	Trachompinzette, KNAPP-LUER .....	393
STRAUSS, Penisklemme .....	553/1	TILLEY, Ohrzängchen .....	411	Tränenkanaldilatator, ZIEGLER .....	381
STRUEMPEL, Fremdkörperzängchen .....	412	TISCHLER-DOWN, Uterus-Biopsiezange .....	591	Tränenkanaldilatator, CASTROVIEJO .....	381
STRULLY, neuro-chirurgische Schere .....	65	TISCHLER-KEVORKIAN, Uterus-Biopsiezange .....	592	Tränenkanaldilatator, WILDER .....	381
STRUYCKEN, Nasenzange .....	427	TISCHLER-MORGAN, Uterus-Biopsiezange .....	590, 591	Tränenkanalsonde, BOWMAN .....	381
SUBRAMANIAN, Kinder-Gefäßklemme .....	521	TISCHLER-UP, Uterus-Biopsiezange .....	591	Tränensackdissektor, LANG .....	378
SUBRAMANIAN-MINIATURE, Kinder-Gefäßklemme .....	521	Titan-Arterienklemme, CRILE .....	107	Tränensackhähchen, KNAPP .....	375
Supercutschere .....	71			Tränensackhähchen, ROLLET .....	375

TRAVERS, Wundspreizer.....	172	Unterbindungsnadel, KRONECKER.....	219	Verbandschere, SMITH US ARMY.....	69/1
TRELAT, Scheidenspekula.....	571	Unterbindungsnadel, NELSON.....	219	Verbandschere, UNIVERSAL.....	70
Trepbine, KEYES.....	608	Unterkieferhaken, HARGIS.....	463, 463/6	Verbandstoffrommel, SCHIMMELBUSCH.....	622
TROELTSCH, Nasenpinzette.....	424	Urethrotom, OTIS.....	553	Verbindungskabel.....	633
TROELTSCH, Ohrpinzette.....	410, 424	US-ARMY, Wundhaken.....	141	VERBRUGGE, Knochenhaltezeange.....	245
TROEMNER, Perkussionshammer.....	24	USA, anatomische Pinzette.....	81	VERBRUGGE-MÜLLER, Knochenhebel.....	287
Trokar, SINOSKOPIE.....	205	USA Modell, Verbindungskabel.....	633	VERESS, Insufflationskanüle.....	206
Trokar, NELSON.....	205	Uterusdilator, GOODELL.....	581	Verlängerungsrohr, BRUENINGS.....	472
Trokar, OCHSNER.....	205	Uterusdilator, HANK.....	580	Verlängerungsstück.....	299
Trokar, UNIVERSAL.....	204	Uterusdilator, PRATT.....	580	VIENNA, Führungshohlsonde.....	221
Trokar, STANDARD (NELSON).....	204	Uterusdilator, SIMS.....	581	VIRCHOEW, Seziermesser.....	48
TROUSSEAU-BABY, Trachealdilatator.....	476	Uterusdilator, WYLIE.....	581	VIRTUS (RALK), Splitterzange.....	92
TROUSSEAU, Trachealdilatator.....	476	Uteruspolypenzange, DOYEN.....	585	VOLKMANN, Doppelloffel.....	257
TROUTMAN, Irispinzette.....	384	Uteruspolypenzange, KELLY.....	585	VOLKMANN, Knochenhaken.....	156
TROUTMAN, Muskelpinzette.....	389	Uteruspolypenzange, NOTO.....	585	VOLKMANN, scharfer Löffel.....	251, 257
TROUTMAN-CHRIS, Klängenbrecher.....	45	Uterus-Biopsiezeange, KEVORKIAN-PACIFIC.....	592	VOLKMANN, Wundhaken.....	153, 154, 156
TUBBS, Aortadilatator.....	528	Uterus-Biopsiezeange, SCHUMACHER.....	589	VOLTOLINI, Nasenspekula.....	421
Tubenkatheter f. SCHULTZE.....	596	Uterus-Biopsiezeange, TISCHLER-KEVORKIAN.....	592	Vorbohrer, KUENTSCHER.....	321
Tuchklemme.....	133	Uterus-Biopsiezeange, TOWNSEND.....	591	VU-MORE, Scheidenspekula.....	569
Tuchklemme, BALL AND SOCKET.....	133	Uterus-Biopsiezeange, ALEXANDER.....	589	W	
Tuchklemme, BACKHAUS.....	132	Uterus-Biopsiezeange, BABY-TISCHLER.....	592	WACHENFELDT, Wundklammerpinzette.....	224
Tuchklemme, BACKHAUS-CLIP.....	132	Uterus-Biopsiezeange, BURKE.....	590	WADSWORTH-TODD, Cauter.....	378
Tuchklemme, BERNHARD.....	133	Uterus-Biopsiezeange, BURKE-BABY.....	590	WAGENER-MOSHER, Trachealkanüle.....	477
Tuchklemme, DOYEN.....	133	Uterus-Biopsiezeange, EPPENDORFER.....	590	WAGNER, Hähchen.....	409
Tuchklemme, JONES.....	132	Uterus-Biopsiezeange, KEVORKIAN.....	589, 591	WAGENSTEEN, Gefäßpinzette.....	89
Tuchklemme, JONES-CLIP.....	132	Uterus-Biopsiezeange, MAXI GRASPER.....	593	WAGNER, Laminektomiezeange.....	343
Tuchklemme, LANE.....	133	Uterus-Biopsiezeange, MINI-TOWNSEND-DOWN.....	591	WAGNER, SCHERE.....	67
Tuchklemme, LORNA.....	133	Uterus-Biopsiezeange, MINI-TOWNSEND-UP.....	591	WAGNER, Supercutschere.....	72
Tuchklemme, MOYNIHAN.....	133	Uterus-Biopsiezeange, TISCHLER-DOWN.....	591	WALDMANN, Episotomie-Schere.....	64
Tuchklemme, PEERS.....	132	Uterus-Biopsiezeange, TISCHLER-MORGAN.....	590, 591	WALLICH, Abortuslöffel.....	607
Tuchklemme, ROEDER.....	132	Uterus-Biopsiezeange, TISCHLER-UP.....	591	WALSHAM, Septumrichtzange.....	449
Tuchklemme, SCHAEDEL.....	132	Uterus-Biopsiezeange, WITNER.....	589	WALTON, Fremdkörperhohlmeißel.....	374
Tuchklemme, TOHOKU.....	132	Uterus-Depressor, BRAUN.....	586	WALTON, Fingerringssäge.....	297
TUFFIER, Gewebefabzange.....	110	Uterus-Depressor, SIMS.....	586	WALTON, Komodonenquetscher.....	608
TUFFIER, Rippensperner.....	487	Uterus-Dilatator, HEGAR.....	578, 579	Wangenhalter.....	453, 451
TUFFIER, Wundhaken.....	147	Uterus-Faßzange, COLLIN.....	585	Wangenhalter, CAWOOD-MINNESOTA.....	451
Tumorfasszange, LANDOLT.....	341	Uterus-Faßzange, DARTIGUES.....	585	Wangenhalter, STERNBERG.....	453
Tumorzinzette, YASARGIL.....	97	Uterus-Faßzange, SOMER.....	585	WANGENSTEEN, Nadelhalter.....	210
Tupferzange, BRYANT.....	137	Uterus-Kürette, BLAKE.....	595	WARTENBERG, Nervrädchen.....	25
Tupferzange, CHERON.....	137	Uterus-Kürette, BUMM.....	597, 598	WATSON, Dermatoma.....	50
Tupferzange, COLLIN.....	137	Uterus-Kürette, RECAMIER.....	597, 598	WATSON-CHEYNE, Elevator.....	283
Tupferzange, FOERSTER.....	136	Uterus-Kürette, SIMS.....	597, 598	WATSON-CHEYNE, Sonde.....	199
Tupferzange, LISTER (SINUS).....	137	Uterus-Kürette, THOMAS.....	599	WATSON-WILLIAMS, Nasenzange.....	428
Tupferzange, PELKMANN.....	137	Uterus-Löffel, SIMON.....	594	Watteträger, FARRELL.....	203
Tupferzange, RAMPLEY.....	136	Uterus-Löffel, GOURDET.....	599	Watteträger, JOBSON-HORNE.....	203
TURNBULL, Nagelzange.....	609	Uterus-Löffel, SCHRÖDER.....	595	Watteträger, REDA.....	203
TURREL, Mastdarmbiopsiezeange.....	567	Uterus-Sonde, VALLEIX.....	586	Watteträger, TOBOLD.....	203
TYDING, Tonsillenschürer.....	469	Uterus-Sonde, COLLIN.....	586	Watteträger, UCKERMANN.....	203
TYDING, Tonsillenzange.....	468	Uterus-Sonde, MARTIN.....	586	WAUGH, chirurgische Pinzette.....	83
TYDING, Tonsillotom.....	469	Uterus-Sonde, SIMS.....	586	WEBER, Aortaklemme.....	501
U		Uterus-Zange, GREEN-ARMYTAGE.....	605	WEBER, Starschlinge.....	378
USA MOD., Nabelschnur-Schere.....	64	V		WEBSTER, Nadelhalter.....	208
UCKERMANN, Watteträger.....	203	VALLEIX, Uterus-Sonde.....	586	WECKER, Augenschere.....	75
Uhmacher Pinzette.....	90	Valve f. Bauchdeckenhalter, BALFOUR.....	183	WECKER, Irisspatel.....	378
ULRICH, Knochenhaltezeange.....	248	Valve f. Bauchdeckenhalter, HORGAN.....	183	WEEK, Lidsperner.....	370
ULRICH, Kornzange.....	135	Valven f. Scheidenspekula, O'SULLIVA-O'CONNOR.....	576	WEIL-BLAKESLEY, Nasenzange.....	426
ULTA-LIGHT, Pinzette, atrauma.....	95	VAN BUREN, Dilatationsbougie.....	554	WEITLANER, Wundspreizer.....	169
UNI I, Diagnostik-Besteck.....	13	VAN BUREN, Knochenhaltezeange.....	249	WEITLANER-WULLSTEIN, Wundspreizer.....	169
UNI III, Diagnostik-Besteck.....	15	VAN DOREN, Biopsiezeange.....	588	WELLER, Präparierschere.....	53/2
UNIVERSAL, Drahtschere.....	67	VANNAS, Augenschere.....	79	WELLS, Enukleationslöffel.....	378
UNIVERSAL, Endoskophalterung.....	188	VARADY, Varizeninstrument.....	202	WERTHEIM, gynäkologische Schere.....	62
UNIVERSAL, Pulverbläser.....	405	Varizeninstrument, VARADY.....	202	WERTHEIM, Hysterektomieschere.....	63
UNIVERSAL, Sterilisierzange.....	227	Vasektomieklemme.....	553/1	WERTHEIM, Hysterektomieklemme.....	124, 128
UNIVERSAL, Trokar.....	204	Verbandschere.....	70	WERTHEIM-CULLEN, Nierenstielklemme.....	125
UNIVERSAL, Verbandschere.....	70	Verbandschere, BERGMANN.....	69/1	WEST, Hohlmeißel.....	442/1
Universalgriff, HUBER.....	472	Verbandschere, BRUNS.....	70	WEST, Nasenmeißel.....	442/1
Universelle Wundhakenhalterung für Armsystem.....	188	Verbandschere, ESMARCH.....	69/2	WESTCOTT, Augenschere.....	75
UNNA, Komodonenquetscher.....	608	Verbandschere, KNOWLES.....	70	WESTMACOTT, Nasentamponzange.....	424
Unterbindungsnadel.....	218	Verbandschere, LISTER.....	69/1	WESTON, Rektalschnürer.....	566
Unterbindungsnadel, SCHMIEDEN-DICK.....	219	Verbandschere, LORENZ.....	70	WHEELER, Disziionsmesser.....	373
Unterbindungsnadel, COOPER.....	219	Verbandschere, REDA EXCENTER.....	69/2	WHEELER, Zyklotrialspatel.....	379
Unterbindungsnadel, DESCHAMPS.....	218	Verbandschere, SEUTIN.....	69/2	WHITE, Tonsillenzange.....	467

WIEDER, Zungendrucker .....	452	Wundhaken, ISRAEL .....	162	WYLIE, Uterus-Dilatator .....	581
WIENER, Antrumraspel .....	443	Wundhaken, JANSEN .....	168	Y	
WIENER, Irishäkchen .....	375	Wundhaken, KELLY .....	164	YANCOSKIE, Wundhaken .....	198
WIGMORE, Gipsmesser .....	229	Wundhaken, KELLY-GRIP .....	142	YANKAUER, Saugrohr .....	27
WIKSTROEM, Arterienklemme .....	117	Wundhaken, KLAPP .....	150	YANKAUER, Tonsillen-Dissektor .....	465
WILDE, Polypenschürer .....	411, 433/2	Wundhaken, KOCHER-LANGENBECK .....	159	YASARGIL, Galeahaken .....	330
WILDE (TROELTSCH), Ohrpinzette .....	410	Wundhaken, KOERTE .....	162	YASARGIL, Gefäßschl. ....	345 - 356
WILDER, Starschlinge .....	378	Wundhaken, LAHEY .....	157	YASARGIL, SAUGROHR .....	337/1
WILDER, Tränenkanal-Dilatator .....	381	Wundhaken, LANGENBECK .....	158, 159	YASARGIL, Tumorzpinzette .....	97
WILLET-MARTEL, Faßzange .....	110	Wundhaken, LANGENBECK-GREEN .....	153	YEOMAN, Mastdarm-Biopsiezange .....	566, 567
WILLIAMS, Darmfaßzange .....	539	Wundhaken, LITTLE .....	157	YOUNG-BOOMERANG, Nadel .....	220
WILLIAMS, Lidsperrerr .....	370	Wundhaken, LOVE .....	465	YOUNG, Prostatahaken .....	550
WILLIAMS, Schraubenzieher .....	323	Wundhaken, MATHIEU .....	141	YOUNG, Zungenzange .....	453
WILLIGER, Hammer .....	271	Wundhaken, MIDDELDORPF .....	160	Z	
WILLIGER, Raspator .....	276	Wundhaken, MIKULICZ .....	163	Zahnfleischschere, LA GRANGE .....	69
WILLIGER, scharfer Löffel .....	255, 257	Wundhaken, NAGER .....	465	Zahnfleischschere, Supercut, LA GRANGE .....	72
Winkelmesser, MOELTGEN .....	25	Wundhaken, OBWEGESER .....	460, 461	Zahnfleischschere, GOLDMAN-FOX .....	67
WINTER, Abortuszange .....	606	Wundhaken, OLLIER .....	162	Zahnfleischschere, LOCKLIN .....	69
Wirbelkörperspreizer, CLOWARD .....	339	Wundhaken, PARKER .....	139	Zahnfleischschere, QUINBY .....	67
Wirbelkörperspreizer, INGE .....	339	Wundhaken, RAGNELL .....	140	Zahnpinzette, LONDON-COLLEGE .....	93
WITTNER, Uterus-Biopsiezange .....	589	Wundhaken, RAMUS .....	461	Zahnpinzette, MERIAM .....	93
WOLFF, Gipsbreißeizange .....	233	Wundhaken, RICHARDSON .....	142	Zange, JURASZ .....	471
WOODSON, Dura-Dissektor .....	333	Wundhaken, RICHARDSON-GRIP .....	142	ZAUFAL, Ohrhebel .....	409
WORST, Sonde .....	381	Wundhaken, RICHARDSON-EASTMAN .....	142	ZAUFAL-JANSEN, Hohlmeißelzange .....	238
WRIGLEY, Geburtszange .....	602	Wundhaken, ROSE .....	140	ZAUFAL-JANSEN, Ohrhebel .....	409
WULLSTEIN, Messer .....	418	Wundhaken, ROUX .....	139	ZIEGLER, Lidsperrerr .....	371
WULLSTEIN, Mikro-Löffelzängchen .....	416	Wundhaken, ROUX-BABY .....	140	ZENKER, Arterienklemme .....	118
WULLSTEIN, Mikro-Ohrzängchen .....	416	Wundhaken, ROUX-Mini .....	140	ZENKER, Wundhaken .....	161
WULLSTEIN, Sauggriff .....	338	Wundhaken, SAUERBRUCH .....	164, 166	zerlegbare Stanze, FERRIS-SMITH-KERRISON .....	344/2
WULLSTEIN, Wundspreizer .....	171	Wundhaken, SENN-GREEN .....	153	ZIEGLER, Disziionsmesser .....	373
Wundhaken .....	463/3	Wundhaken, SENN-MILLER .....	143	ZIEGLER, Irismesser .....	372
Wundhaken, ANDERSON .....	198	Wundhaken, SIMON .....	164	ZIEGLER, Stirnspiegel .....	21
Wundhaken, AUFRANC-COBRA .....	289	Wundhaken, SPINA-NASALIS .....	461	ZIEGLER, Tränenkanal-Dilatator .....	381
Wundhaken, BREAST .....	198	Wundhaken, STRANDELL-STILLE .....	157	ZIELKE, Hohlmeißel .....	264
Wundhaken, CORONAL-BLOW-LIFT .....	198	Wundhaken, VOLKMANN .....	153, 154, 156	Zirkular-Stanze .....	432
Wundhaken, FERRIERA .....	197	Wundhaken, ZENKER .....	161	ZÖLLNER, Saugrohr .....	337/1
Wundhaken, FINSEN .....	168	Wundhaken, KOCHER .....	155, 159, 160, 163	Zubehör f. Autopsiesäge .....	231/2, 231/3
Wundhaken, FREEMAN .....	198	Wundhaken, US-ARMY/PARKER-LANGENBECK .....	141	Zughaken, KIRSCHNER .....	313
Wundhaken, KÖNIG .....	153	Wundhakenhalterung .....	188	Zughebel, BARTON .....	603
Wundhaken, MEYERDING .....	177	Wundklammern, MICHEL .....	224	Zughebel, BILL .....	604
Wundhaken, MORRIS .....	164	Wundklammerpinzette, HEGENBARTH .....	224	Zughebel, LUIKART-BILL .....	604
Wundhaken, MURPHY .....	156	Wundklammerpinzette, MICHEL .....	224	Zugsseil f. NABATOFF .....	201
Wundhaken, St. MARKS .....	165	Wundklammerpinzette, WACHENFELDT .....	224	Zungendrucker, ANDREW .....	452
Wundhaken, TEBBETTS .....	197	Wundklammerzange, CHILDE .....	224	Zungendrucker, DAVIS-BOYLE .....	455
Wundhaken, TUFFIER .....	147	Wundklammerzange, COLLIN .....	224	Zungendrucker, DINGMANN .....	456
Wundhaken, YANCOSKIE .....	198	Wundklammerzange, MICHEL .....	224	Zungendrucker, HARTMANN .....	452
Wundhaken, ALM .....	168	Wundklammerzange, RICHTER-HEATH .....	224	Zungendrucker, KILNER-DOUGHTY .....	456
Wundhaken, BRUNNER .....	167	Wundlöffel, ARRUGA .....	378	Zungendrucker, TOBOLD .....	453
Wundhaken, COLLIN .....	139	Wundnahtbesteck .....	225, 226	Zungendrucker, WIEDER .....	452
Wundhaken, COLLIN-HARTMANN .....	141	Wundsperrerr, CLOWARD .....	178	Zungenspatel .....	451
Wundhaken, COOLEY .....	148	Wundspreizer, ADSON .....	172 - 174	Zungenspatel, BRUENINGS .....	451
Wundhaken, CORYLLOS .....	166	Wundspreizer, CASPAR .....	179	Zungenspatel, BUCHWALD .....	451
Wundhaken, CRILE .....	140	Wundspreizer, MAYO-ADAMS .....	171	Zungenspatel, DOUGHTY .....	458
Wundhaken, CUSHING .....	151, 152	Wundspreizer, NORFOLK/NORWICH .....	172	Zungenspatel, FRENZEL .....	451
Wundhaken, DAVIDSON (Scapula) .....	166	Wundspreizer, PERKINS .....	168	Zungenspatel, KROENIG .....	451
Wundhaken, DEEVER .....	145, 146	Wundspreizer, PLESTER .....	171	Zungenspatel, MAYO .....	451
Wundhaken, DEEVER-GRIP .....	146	Wundspreizer, SCALP-CONTOUR .....	169	Zungenspatel, MORITZ-SCHMIDT .....	452
Wundhaken, DESMARRES .....	151	Wundspreizer, TRAVERS .....	172	Zungenspatel, RING .....	455
Wundhaken, DOYEN .....	163	Wundspreizer, WEITLANER-WULLSTEIN .....	169	Zungenspatel, RUSSEL-DAVIS .....	458
Wundhaken, DOYEN-STILLE .....	167	Wundspreizer, WULLSTEIN .....	171	Zungenzange, COLLIN .....	453
Wundhaken, FARABEUF .....	139	Wundspreizer, ADSON-BABY .....	173	Zungenzange, YOUNG .....	453
Wundhaken, FRITSCH .....	163	Wundspreizer, ANDERSON-ADSON .....	172	Zwischenknochen-Messer .....	44
Wundhaken, GIL-VERNÉT .....	152	Wundspreizer, BECKMANN .....	176	Zwischenstück f. SCHULTZE Salpingograph .....	596
Wundhaken, GOELET .....	141	Wundspreizer, BECKMANN-ADSON .....	175	Zyklodialysespatel, BANGERTER .....	379
Wundhaken, GREEN .....	160	Wundspreizer, BECKMANN-EATON .....	176	Zyklodialysespatel, ELSCHNIG .....	379
Wundhaken, HARGIS .....	463	Wundspreizer, BOSE .....	476	Zyklodialysespatel, HIRSCHMANN .....	379
Wundhaken, HARRINGTON .....	147	Wundspreizer, DARLING .....	178	Zyklodialysespatel, WHEELER .....	379
Wundhaken, HARRINGTON-PEMBERTON .....	147	Wundspreizer, HENLEY .....	170	Zyklodialysespatel, CASTROVIEJO .....	379
Wundhaken, HEANEY .....	164	Wundspreizer, MARTIN .....	175/1		
Wundhaken, HIBBS .....	164	Wundspreizer, MEYERDING .....	180		
Wundhaken, HOESEL .....	167	Wundspreizer, MOLLISON .....	171		
Wundhaken, HOFER .....	465	Wundspreizer, PLESTER .....	171		
Wundhaken, HOLZHEIMER .....	168	Wundspreizer, WEITLANER .....	169		

ABDOMINAL- A. BOWEL SPATULA KÜMMEL.....	143/2, 144	ANAL RETRACTOR SMITH-BUIE .....	561	ATRAUMATIC TISSUE FORCEPS DEBAKEY.....	99
ABDOMINAL RETRACTOR KIRSCHNER.....	187, 187/1	ANAST.KL. DE MARTEL-WOLFSON .....	546	AUFRANC RETRACTOR .....	289
ABDOMINAL RETRACTORS BABY GOSSET.....	181	ANASTOMOSIS CLAMP BECK.....	516	AUFREIBER KUENTSCHER.....	321
ABDOMINAL RETRACTORS BALFOUR.....	182	ANASTOMOSIS CLAMP BECK .....	520	AUFRICHT NOSE HOOK .....	447
ABDOMINAL RETRACTORS BALFOUR BABY .....	182	ANASTOMOSIS CLAMP COOLEY .....	519, 520	AUFRICHT NOSE RASP .....	443
ABDOMINAL RETRACTORS BALFOUR-US.....	184	ANASTOMOSIS CLAMP COOLEY-DERRA .....	519	AURIKELCLAMP HARKEN.....	503
ABDOMINAL RETRACTORS CHARNELY.....	289	ANASTOMOSIS CLAMP DEBAKEY .....	505	AUTOPSY KNIVES .....	48
ABDOMINAL RETRACTORS COLLIN.....	190	ANASTOMOSIS CLAMP LAMBERT-KAY .....	505	AUTOPSY SAW .....	231/1
ABDOMINAL RETRACTORS COLLIN-LOKTITE.....	191	ANATOMIC TISSUE FORCEPS BROPHY .....	84	AUVARD VAGINAL SPECULA.....	576
ABDOMINAL RETRACTORS DENIS-BROWNE.....	186	ANATOMIC TISSUE FORCEPS.....	81	AWL .....	304
ABDOMINAL RETRACTORS DOYEN.....	189/1	ANATOMIC TISSUE FORCEPS ADSON .....	81/2	AWL HARGIS.....	463
ABDOMINAL RETRACTORS FRAZIER.....	181	ANATOMIC TISSUE FORCEPS ADSON MICRO .....	81/2	AWL PERTHES.....	304
ABDOMINAL RETRACTORS GELPI.....	189/1, 189/2	ANATOMIC TISSUE FORCEPS BONNEY.....	88	AXENFELD CHALAZIO CURETTE.....	377
ABDOMINAL RETRACTORS GOSSET.....	181	ANATOMIC TISSUE FORCEPS CUSHING .....	83	AYER CHALAZIO TISSUE FORCEPS.....	393
ABDOMINAL RETRACTORS KIRSCHNER.....	185, 187	ANATOMIC TISSUE FORCEPS CUSHING-TAYLOR.....	87		
ABDOMINAL RETRACTORS RICARD.....	191	ANATOMIC TISSUE FORCEPS DUEHRSEN .....	84	<b>B</b>	
ABDOMINAL RETRACTORS RIGBY.....	189/2	ANATOMIC TISSUE FORCEPS GERALD.....	86	BABCOCK BOWEL GRASPING FORCEPS.....	539
ABDOMINAL RETRACTORS ROCHARD.....	186	ANATOMIC TISSUE FORCEPS MCINDOE .....	85	BABINSKI PERCUSSION HAMMER.....	24
ABDOMINAL SPATULA KADER.....	143/1	ANATOMIC TISSUE FORCEPS POTTS-SMITH.....	81	BABY BURKE BIOPSY FORCEPS.....	590
ABDOMINAL SPATULA LERICHE.....	143/2	ANATOMIC TISSUE FORCEPS SEMKEN.....	86	BABY GOSSET ABDOMINALRETRACTORS.....	181
ABLI OPHTHALMOLOGIC SCISSORS.....	58	ANATOMIC TISSUE FORCEPS TAYLOR .....	87	BABY METZENBAUM SUPERCUT SCISSORS.....	591
ABRAHAM TONSIL FORCEP.....	468	ANATOMIC TISSUE FORCEPS TC.....	81	BABY TISCHLER RONGEUR.....	72
ABRAHAM TONSIL KNIVES.....	466	ANATOMIC TISSUE FORCEPS TYPE USA .....	81	BABY WEBSTER NEEDLE HOLDER .....	208
ACCESSORIES FOR AUTOPSY SAW.....	231/3	ANATOMIC TISSUE FORCEPSSTILLE .....	81	BABY YANKAUER SUCTION TUBE .....	27
ADENOID CURETTE BARNHILL.....	450	ANDERSON ADSON RETRACTORS .....	172	BABY-KOCHER BOWEL CLAMP .....	540
ADENOID CURETTE BECKMANN.....	450	ANDERSON RETRACTOR.....	198	BABY-OLSEN-HEGAR NEEDLE HOLDER.....	212
ADENOID CURETTEST..CLAIR-THOMSON.....	450	ANDREW TONGUE DEPRESSOR .....	452	BABYPHON SPHYGMOMANOMETER.....	10
ADENOTOM LA FORCE.....	450	ANDREW-PYNCHON SUCTION TUBE .....	28	BACK HOLDER ABDOMINAL RETRACTOR SYSTEM .....	192, 193, 194, 195
ADLERKREUTZ VASCULARTISSUE FORCEPS.....	84	ANESTOPHON.....	23	BACKHAUS TOWEL CLAMP .....	132
ADSON RETRACTORS.....	173	ANEURYSM CLAMP DEBAKEY-BAHNSON.....	506	BACKHAUS-CLIP.....	132
ADSON ANATOMIC TISSUE FORCEPS.....	81/2	ANEURYSM CLIPS APPLIER FORCEPS.....	357, 358, 359, 360	BAILEY RIB SPREADER .....	489
ADSON ANATOMIC TISSUE FORCEPS.....	81/2	ANEURYSM VASCULAR CLIP YASARGIL .....	349, 350, 351, 352, 353, 354, 355, 356	BAILEY-BABY RIB SPREADER .....	489
ADSON BABY HEMOSTATIC CLAMP.....	113	ANOSCOPE HIRSCHMANN.....	562	BAILEY-GIBBON RIB SPREADER.....	489
ADSON BONE RONGEUR.....	236	ANOSCOPE IVES-FANSLER.....	562	BAINBRIDGE HEMOSTATIC CLAMP .....	120
ADSON DURAHOOK.....	328	ANTRUM CURETTE COAKLEY .....	449	BAINBRIDGE VASCULAR CLAMP .....	495
ADSON HEMOSTATIC CLAMP.....	112	ANTRUM RASP GALLAHER .....	446	BAKES GALL DUCT DILATOR .....	532
ADSON HOLDING CLAMP.....	298	ANTRUM RASP LEWIS.....	443	BALFOUR ABDOMINALRETRACTORS.....	182
ADSON HYPOPHYSE-TISSUE FORCEPS.....	334	ANTRUM CURETTE.....	435	BALFOUR BABY ABDOMINALRETRACTORS .....	182
ADSON MICRO ANATOMIC TISSUE FORCEPS.....	81/2	ANVIL NAILSPALTFORCEPS .....	613	BALFOUR HOOK .....	193
ADSON MICRO SURGICAL TISSUE FORCEPS.....	81/2	AORTIC DILATOR COOLEY .....	528	BALFOUR-US ABDOMINALRETRACTORS.....	184
ADSON NEEDLE HOLDER.....	211	AORTIC-DILATOR TUBBS .....	528	BALL AND SOCKET TOWEL CLAMP .....	133
ADSON RASPATORIES.....	282	APPENDIXBOWEL CLAMP ALLEN.....	544	BALL ELECTRODE MONOPOLAR .....	628, 629
ADSON RETRACTORS.....	172, 173, 174	APPENDIXBOWEL CLAMP KLEINSCHMIDT.....	544	BALLENGER SCHWINGKNIVES.....	436
ADSON SUCTION TUBE.....	337	APPLIER FORCEPS ANEURISMEN CLIP .....	357, 358, 359, 360	BALLENGER SEPTUM ELEVATOR.....	439
ADSON SURGICAL TISSUE FORCEPS.....	81/2	APPLIER FORCEPS BIEMER.....	361, 366	BALLENGER TONSIL FORCEPS.....	467
ADSON-BROWN SURGICAL TISSUE FORCEPS.....	82	APPLIER FORCEPS MEHDORN .....	362	BANDAGE CUFF.....	295
ADSON-DEBAKEY ATRAUMATIC FORCEPS.....	81/2	APPLIERFORCEPS JOHNS-HOPKINS.....	104	BANDAGE DRUMSSCHIMMELBUSCH .....	622
AHLE OBWEGESER.....	463	APPLIERFORCEPS MC KENZIE.....	326	BANDAGE SCISSORS.....	70
AIR BLOWER.....	405	APPLIERFORCEPS SMITHWICK.....	326	BANDAGE SCISSORS BERGMANN .....	69/1
AIR BLOWER POLITZER.....	406	APPLIERFORCEPS SWEET.....	326	BANDAGE SCISSORS BRUNS.....	70
AIR INJECTION EYE CANNULA .....	394	APPLING FORCEPS RANEY.....	327	BANDAGE SCISSORS ESMARCH.....	69/2
AIR PUMP .....	295	APPROXIMATOR BIEMER.....	366	BANDAGE SCISSORS KNOWLES.....	70
ALAN-PARKS RECTAL-SPECULA .....	561	APPROXIMATOR BIEMER-MÜLLER.....	363	BANDAGE SCISSORS LISTER .....	69/1
ALDERDYCE ELEVATOR.....	282	APPROXIMATOR MÜLLER.....	364	BANDAGE SCISSORS LORENZ.....	70
ALEXANDER BIOPSY FORCEPS.....	589	ARCHER SPLINTERFORCEPS .....	92	BANDAGE SCISSORS REDA EXCENTER .....	69/2
ALEXANDER CHISELS.....	259	ARLT CATARACT LOOP .....	378	BANDAGE SCISSORS SEUTIN .....	69/2
ALEXANDER RASPATORIES.....	276	ARMSYSTEM .....	188	BANDAGE SCISSORS SMITH US ARMY .....	69/1
ALLEN APPENDIX BOWEL CLAMP.....	544	ARRUGA CAPSULAR FORCEPS.....	391	BANDAGE SCISSORS UNIVERSAL.....	70
ALLIS BOWEL GRASPING FORCEPS.....	537	ARRUGA EXTRAKTION HOOK .....	375	BANE-HARTMANN BONE RONGEUR.....	237
ALLIS-ADAIR BOWEL GRASPING FORCEPS.....	537	ARRUGA EYE SPECULA .....	370	BANGERTER CYCLODIALYSIS SPATULA .....	379
ALLISON LUNG SPATULA .....	489	ARRUGA NEEDLE HOLDER .....	214	BARACANI INTERCHANGEABLE TIPS .....	472
ALM RETRACTOR.....	168	ARRUGA WOUND CURETTE.....	378	BARANY AIR BLOWER.....	405
ALVIS FOREIGN-BODY CURETTE.....	374	ASCH SEPTUM STRAIGHTENING FORCEPS.....	449	BARBARA HOOK .....	419
AMNIOSKOPE.....	601	ATRAUMA BULLDOG CLAMP .....	100	BARBARA NEEDLE.....	419
AMNIOTOME BEACHAM.....	586	ATRAUMA BULLDOG CLAMP.....	100, 102	BARKAN GONIOTOMY KNIVES .....	373
AMPUTATION KNIVES CATLIN.....	44	ATRAUMA CLAMP DEBAKEY.....	100	BARNHILL ADENOID CURETTE .....	450
AMPUTATION KNIVES LANGENBECK.....	44	ATRAUMA CLAMP DEBAKEY.....	103	BARON SUCTION TUBE.....	336
AMPUTATION KNIVES LISTON.....	44	ATRAUMA CLAMP GLOVER.....	100	BARR RECTAL-SPECULA.....	559
AMPUTATION KNIVES REDA.....	44	ATRAUMA-BULLDOG CLAMP GLOVER .....	103	BARRAQUER CILIA FORCEPS.....	395
AMPUTATION SAW BIER .....	296	ATRAUMA-NEONATAL CLAMP.....	523	BARRAQUER EYE SPECULA .....	370
AMPUTATION SAW CHARRIERE.....	296	ATRAUMATIC FORCEPS ADSON-DEBAKEY .....	81/2	BARRAQUER EYESCISSORS.....	75
AMPUTATION SAW SATTERLEE.....	296			BARRAQUER FIXATION FORCEPS.....	390

BARRAQUER KERATOPLAST-KNIVES.....	373	BIPOLAR-CABLE.....	633	BONE HOLDING FORCEPS.....	249
BARRAQUER NEEDLE HOLDER.....	217	BIPOLAR-TISSUE FORCEPS.....	630, 631	BONE HOLDING FORCEPS BIRCHER-GANSKE.....	246
BARRAQUER NEEDLE HOLDER.....	216, 217	BIPOLAR-TISSUE FORCEPS BAJONETT.....	632	BONE HOLDING FORCEPS DINGMANN.....	246
BARRAQUER-KATZIN IRIS TISSUE FORCEPS.....	384	BIRCHER-GANSKE BONE HOLDING FORCEPS.....	246	BONE HOLDING FORCEPS FARABEUF.....	243
BARRET HOOK FORCEPS.....	582	BIRKETT HEMOSTATIC CLAMP.....	116	BONE HOLDING FORCEPS FARABEUF-L.....	243
BARTON OBSTETRICAL FORCEPS.....	603	BISHOP-HARMAN IRIS TISSUE FORCEPS.....	386	BONE HOLDING FORCEPS FERGUSSON.....	243
BATTERY HANDLE F. COLD LIGHT.....	33	BISHOP-HARMAN IRRIGATION CANNULA.....	394/1	BONE HOLDING FORCEPS KERN.....	244
BATTERY HANDLE F. WARM LIGHT.....	32	BLADDER RETRACTORS LEGUE.....	553	BONE HOLDING FORCEPS LAMBOTTE.....	244
BAUMGARTNER NEEDLE HOLDER.....	208	BLADDER RETRACTORS MILLIN.....	552	BONE HOLDING FORCEPS LANE.....	244
BEACHAM AMNIOTOME.....	586	BLADDER RETRACTORS THOMSON-WALKER.....	552	BONE HOLDING FORCEPS LANGENBECK.....	243
BECHERT NUCLEUS ROTATOR.....	379	BLADDER RETRACTORSJUDD-MASSON.....	552	BONE HOLDING FORCEPS LEWIN.....	246
BECK ANASTOMOSIS KL.....	520	BLADDER SPATULA KOCHER.....	552	BONE HOLDING FORCEPS REDA.....	246, 247
BECK VASCULAR CLAMP.....	516	BLADDER SPATULA LEGUEU.....	552	BONE HOLDING FORCEPS REILL.....	248
BECKER CYSTOTOM.....	375	BLADDER SPREADER MILLIN.....	553	BONE HOLDING FORCEPS SEMB.....	243
BECKMANN ADENOID CURETTE.....	450	BLADE SCALPEL.....	42	BONE HOLDING FORCEPS ULRICH.....	248
BECKMANN RETRACTORS.....	176	BLADEBREAKER CASTROVIEJO.....	45	BONE HOLDING FORCEPS VAN BUREN.....	249
BECKMANN-ADSON RETRACTORS.....	175	BLADEBREAKER REDA.....	45	BONE HOLDING FORCEPS VERBRUGGE.....	245
BECKMANN-EATON RETRACTORS.....	176	BLADEBREAKER TROUTMAN-CHRIS.....	45	BONE KNIVES.....	44
BED PAN.....	621	BLADE-REMOVER.....	42	BONE LEVERS.....	284, 288
BEEBEE CROWNSCISSORS.....	68	BLADES RAZOR.....	45	BONE LEVERS BENNETT.....	283
BEER CLIA FORCEPS.....	395	BLAKE GALL STONE FORCEPS.....	531	BONE LEVERS BLOUNT.....	288
BEESON PLASTER RETRACTOR.....	232	BLAKE UTERINE CURETTE.....	595	BONE LEVERS HOHMANN.....	284
BELLUCCI MICRO-EAR SCISSORS.....	413	BLOHMKE TONSIL FORCEPS.....	467	BONE LEVERS HOHMANN.....	285
BELLUCCI MICRO-SCISSORS.....	417	BLOOD VESSEL CLAMP DIETRICH.....	510	BONE LEVERS HOHMANN MINI.....	286
BENDER.....	322	BLOOD VESSEL CLAMP MORRIS-DEBAKEY.....	506	BONE LEVERS KOENIG.....	284
BENDER LANE.....	325	BLOOD VESSEL CLAMP WEBER.....	501	BONE LEVERS LANGE-HOHMANN.....	286
BENGOLEA HEMOSTATIC CLAMP.....	112	BLOUNT BONE LEVERS.....	288, 289	BONE LEVERS SMILLIE.....	291
BENNETT BONE LEVERS.....	283	BLOWER KABIERSCHE.....	405	BONE LEVERS VERBRUGGE-MÜLLER.....	287
BENSAUDE PROCTOSCOPE.....	565	BLUMENTHAL BONE RONGEUR.....	236	BONE PLATE HOLDING FORCEPS LANE.....	325
BENSON PYLORUSRETRACTOR.....	544	BODENHAMMER RECTAL-SPECULA.....	559	BONE RONGEUR ADSON.....	236
BERENS DISCISION KNIVES.....	372	BOEHLER EXTENSION BOW.....	312	BONE RONGEUR BANE-HARTMANN.....	237
BERGMANN BANDAGE SCISSORS.....	69/1	BOERMA OBSTETRICAL FORCEPS.....	604	BONE RONGEUR BEYER.....	237, 238
BERGMANN HAMMER.....	272	BOETTCHER TONSIL SCISSORS.....	59	BONE RONGEUR BLUMENTHAL.....	236
BERKE MUSCLE FORCEPS.....	389	BÖHLER BONE CUTTING FORCEPS.....	241	BONE RONGEUR BOEHLER.....	238
BERLINER PERCUSSION HAMMER.....	24	BÖHLER BONE RONGEUR.....	238	BONE RONGEUR CLEVELAND.....	235
BERNHARD TOWEL CLAMP.....	133	BOIES ELEVATOR.....	277	BONE RONGEUR ECHLIN.....	240
BERRY WIRE FORCEPS.....	319	BONACCOLTO STRABISMUS FORCEPS.....	385	BONE RONGEUR FRIEDMAN-MICRO.....	234
BETHUNE RIB SCISSORS.....	481	BONE CURETTES.....	255, 256	BONE RONGEUR FRIEDMAN-MINI.....	234
BEYER BONE RONGEUR.....	237, 238	BONE CURETTES BRUNS.....	251, 254	BONE RONGEUR FRYKHOLM.....	240
BIEMER APPLIER FORCEPS.....	361, 366	BONE CURETTES BUSHE.....	256	BONE RONGEUR JANSEN.....	237
BIEMER APPROXIMATOR.....	366	BONE CURETTES DAUBENSPECK.....	255	BONE RONGEUR KLEINERT-KUTZ.....	237
BIEMER VASCULAR CLIP.....	361	BONE CURETTES HALLE.....	253	BONE RONGEUR LEMPERT.....	237
BIEMER-MÜLLER APPROXIMATOR.....	363	BONE CURETTES JACOBSON.....	257	BONE RONGEUR LUER.....	236
BIER AMPUTATION SAW.....	296	BONE CURETTES JANSEN.....	257	BONE RONGEUR MARQUARD.....	239
BILLEAU EAR LOOP.....	409	BONE CURETTES LEMPERT.....	256	BONE RONGEUR MAYFIELD.....	238
BIOPSY CURETTE HEANY.....	587	BONE CURETTES MARTIN.....	257	BONE RONGEUR MEAD.....	235
BIOPSY CURETTE KEVORKIAN.....	587	BONE CURETTES SCHEDE.....	251	BONE RONGEUR OLIVECRONA.....	237
BIOPSY CURETTE NOVAK.....	587	BONE CURETTES SCOVILLE.....	253	BONE RONGEUR RUSKIN.....	239
BIOPSY CURETTE RANDALL.....	587	BONE CURETTES SPINAL.....	253	BONE RONGEUR SAUERBRUCH.....	240
BIOPSY CURETTE TYPE MÜNCHEN.....	587	BONE CURETTES SPRATT.....	251	BONE RONGEUR SCAGLIETTI.....	240
BIOPSY FORCEPS ALEXANDER.....	589	BONE CURETTES VOLKMANN.....	251, 257	BONE RONGEUR SEMB.....	240
BIOPSY FORCEPS BABY BURKE.....	590	BONE CURETTES WILLIGER.....	255, 257	BONE RONGEUR SMITH-PETERSEN.....	238
BIOPSY FORCEPS BURKE.....	590	BONE CUTTING FORCEPS BOEHLER.....	241	BONE RONGEUR STELLBRINK.....	234
BIOPSY FORCEPS EPPENDORFER.....	590	BONE CUTTING FORCEPS LISTON.....	241	BONE RONGEUR ZAUFAL-JANSEN.....	238
BIOPSY FORCEPS FAURE.....	588	BONE CUTTING FORCEPS MCINDOE.....	241	BONE RONGEURLEKSELL-STILLE.....	240
BIOPSY FORCEPS KERVORKIAN-PACIFIC.....	592	BONE CUTTING FORCEPS RUSKIN.....	241	BONE RONGEURSTILLE-LUER.....	239
BIOPSY FORCEPS KEVORKIAN.....	589	BONE CUTTING FORCEPS SEMB.....	242	BONE RONGEURSTILLE-RUSKIN.....	239
BIOPSY FORCEPS KEVORKIAN.....	591	BONE CUTTING FORCEPSSCOTTE-K.....	241	BONEFENDER NAIL BENDER.....	322
BIOPSY FORCEPS MAXI GRASPER.....	593	BONE CUTTING FORCEPSSTILLE.....	241, 242	BONEHOOK VOLKMANN.....	156
BIOPSY FORCEPS SCHUBERT.....	588	BONE FILES.....	612/1	BONERASP.....	294
BIOPSY FORCEPS SCHUMACHER.....	588, 589	BONE HAND DRILLS BUNELL.....	299	BONERASP PUTTI.....	294
BIOPSY FORCEPS THOMAS-GAYLOR.....	588	BONE HAND DRILLS HUDSON.....	299	BONEWIRE SOFT.....	314
BIOPSY FORCEPS TISCHLER-DOWN.....	591	BONE HAND DRILLS KIRSCHNER.....	299	BONN IRIS TISSUE FORCEPS.....	387
BIOPSY FORCEPS TISCHLER-KERVORKIAN.....	592	BONE HAND DRILLS MOORE.....	298	BONNEY ANATOMIC TISSUE FORCEPS.....	88
BIOPSY FORCEPS TISCHLER-MORGAN.....	591	BONE HAND DRILLS RALK.....	300	BONNEY SURGICAL TISSUE FORCEPS.....	88
BIOPSY FORCEPS TOWNSEND MINI.....	591	BONE HAND DRILLSSTILLE.....	298	BOSE TRACHEA HOOK.....	476, 477
BIOPSY FORCEPS TOWNSEND TISCHLER MINI.....	591	BONE HAND DRILLSSTILLE-SHERMAN.....	298	BOUCHERON EAR SPECULA.....	399
BIOPSY FORCEPS VAN DOREN.....	588	BONE HOLDING CLAMP FELDHEIM.....	249	BOWEL CLAMP BABY-KOCHER.....	540
BIOPSY FORCEPS WITTLER.....	589	BONE HOLDING CLAMP GERSTER.....	250	BOWEL CLAMP BRUNNER.....	543
BIOPSY FORCEPSTISCHLER-MORGAN.....	590	BONE HOLDING CLAMP LAMBERT-LOWMAN.....	249	BOWEL CLAMP DOYEN.....	540
BIOPSY NEEDLE MENGHINI.....	206	BONE HOLDING CLAMP LOWMAN.....	249	BOWEL CLAMP FEHLAND.....	542
BIOPSY NEEDLEFRANKLIN-SILVERMANN.....	206	BONE HOLDING CLAMP LOWMAN-HOGLUND.....	249	BOWEL CLAMP KOCHER.....	540
BIOPSY-/SUCTION CURETTE.....	600	BONE HOLDING FORCEPS.....	249	BOWEL CLAMP MAYO-ROBSON.....	541

BOWEL CLAMP PAYR .....	548	BRUNNER RIB SCISSORS .....	481	CATARACT KNIVES DEUTSCHMANN .....	371
BOWEL CLAMP RESANO .....	542	BRUNS BANDAGE SCISSORS .....	70	CATARACT KNIVES GRAEFE .....	371
BOWEL CLAMP SCUDDER .....	541	BRUNS BONE CURETTES .....	251, 254	CATARACT LOOP ARLT .....	378
BOWEL CLAMPST.ONE-WATT .....	545	BRUSH DISPENCOR .....	611	CATARACT LOOP SNELLEN .....	378
BOWEL GRASPING FORCEPS ALLIS .....	537	BRYANT DRESSINGFORCEPS .....	137	CATARACT LOOP WEBER .....	378
BOWEL GRASPING FORCEPS ALLIS-ADAIR .....	537	BUCHWALD TONGUE DEPRESSORS .....	451	CATARACT LOOP WILDER .....	378
BOWEL GRASPING FORCEPS ALLIS-BABY .....	537	BUCK EAR CURETTE .....	407	CATETHER INTRODUCING FORCEPS MAGILL .....	28
BOWEL GRASPING FORCEPS ATRAUMA .....	111	BUCK FOREIGN-BODY LEVER .....	412	CATHETER FORCEPS COOLEY .....	510
BOWEL GRASPING FORCEPS BABCOCK .....	539	BUCK PERCUSSION HAMMER .....	24	CATHETER GUIDE GUYON .....	554
BOWEL GRASPING FORCEPS COLLIN .....	539	BUCK-GRAMCKO BONE LEVERS .....	285	CATLIN AMPUTATION KNIVES .....	44
BOWEL GRASPING FORCEPS DOYEN-BABY .....	540	BUCK-GRAMCKO BONE LEVERS .....	285	CAUTER WADSWORTH-TODD .....	378
BOWEL GRASPING FORCEPS DUVAL .....	539	BUIE RECTAL ABSUCTION TUBE .....	566	CERVICAL TRACTION TONG CRUTCHFIELD .....	327
BOWEL GRASPING FORCEPS JUDD-ALLIS .....	538	BULLDOG CLAMP ATRAUMA .....	100	CHALAZIO CURETTE AXENFELD .....	377
BOWEL GRASPING FORCEPS LITTLEWOOD .....	538	BULLDOG CLAMP DEBAKEY .....	100, 103	CHALAZIO CURETTE HEBRA .....	377
BOWEL GRASPING FORCEPS LOCKWOOD-ALLIS .....	538	BULLDOG CLAMP DIETRICH .....	101	CHALAZIO CURETTE MEYHOEFFER .....	377
BOWEL GRASPING FORCEPS THOMS-ALLIS .....	538	BULLDOG CLAMP GLOVER .....	103	CHALAZIO TISSUE FORCEPS AYER .....	393
BOWEL GRASPING FORCEPS WILLIAMS .....	539	BULLDOG CLAMP JOHNS-HOPKINS .....	104	CHALAZIO TISSUE FORCEPS DESMARES .....	393
BOWEL SPATULA HABERER .....	143/1	BÜLOW-GUNAR-HEY TUBINGCLAMP .....	130	CHALAZIO TISSUE FORCEPS LAMBERT .....	393
BOWEL SPATULA LERICHE .....	143/2	BUMM UTERINE CURETTE .....	597	CHAPUT TISSUE GRASPING FORCEPS .....	110
BOWEL SPATULA REVERDIN .....	143/1	BUNELL BONE HAND DRILLS .....	299	CHARNLEY ABDOMINALRETRACTORS .....	289
BOWEL SPATULA RIBBON .....	143	BUNELL TENDON GUIDE .....	294	CHARRIERE AMPUTATION SAW .....	296
BOWMAN DISCISION KNIVES .....	372	BUNELL TENDON PASSING INSTR. .....	292	CHEATLE STERILIZATION FORCEPS .....	227
BOWMAN DISCISION NEEDLE GERADE .....	374	BUNGE EXENTERATIONS .....	378	CHEEK RETRACTORSTERNBERG .....	453
BOWMAN EYE SPECULA .....	370	BUNT STERILIZATION CLAMP .....	227	CHEEKSTEIN NEEDLE HOLDER .....	210
BOWMAN LACHRYMAL PROBES .....	381	BURCH FIXATION FORCEPS .....	373	CHELSEA-EATON PROCTOSCOPE .....	563
BOX PETRI .....	620	BURKE BIOPSY FORCEPS .....	590	CHERON DRESSINGFORCEPS .....	137
BOYNTON NEEDLE HOLDER .....	214	BUSCH EPISIOTOMY SCISSORS .....	64	CHERRY LAMINECTOMY RETRACTOR .....	488
BOZEMANN DRESSINGFORCEPS .....	138	BUSHE BONE CURETTE .....	256	CHEST SUPPLY KLEINSASSER .....	36
BOZEMANN NEEDLE HOLDER .....	211	BUTTONPROBES JACOBSON .....	335	CHEVALIER-JACKSON .....	473
BOZEMANN-DOUGLAS DRESSINGFORCEPS .....	138			CHEVALIER-JACKSON TRACHEA CANNULA .....	479
BRAIN KNIVES .....	48	C		CHIEFL CLIP FORCEPS .....	224
BRAIN SPATULA DAVIS .....	337	CABLE BIPOLAR .....	633	CHILDREN ATRAUMA VASCULAR CLAMP .....	526
BRAINSPATULA CUSHING .....	336	CALIPER TOWNLEY .....	26	CHISEL NEVERT-ANDERSON .....	442
BRAINSPATULA CUSHING .....	369	CALIPERS .....	26	CHISELS .....	259, 264
BRAINSPATULA HEIFETZ .....	369	CANFIELD TONSIL-KNIVES .....	466	CHISELS ALEXANDER .....	259
BRAINSPATULA OLIVECRONA .....	336	CANNULA .....	406	CHISELS BRUNETTI .....	268
BRAND TENDON GRASPING INSTRUMENT .....	293	CAPLAN NOSE FORCEPS .....	428	CHISELS COTTLE .....	440
BRAND TENDON PASSING INSTR. .....	294	CAPSULA SCISSORS RESANO .....	53/2	CHISELS HIBBS .....	265
BRAUN CRANIPLAST .....	607	CAPSULAR FORCEPS ARRUGA .....	391	CHISELS HOKE .....	265
BRAUN DECAPITATING HOOK .....	607	CAPSULAR FORCEPS CASTROVIEJO .....	391	CHISELS KILLIAN .....	442/1
BRAUN HOOK FORCEPS .....	582	CAPSULAR FORCEPS ELSCHNIG .....	391	CHISELS LAMBOTTE .....	261
BRAUN UTERINE-DEPRESSOR .....	566	CAPSULAR FORCEPS FUCHS .....	391	CHISELS LEXER .....	263
BRAUN-STADLER EPISIOTOMY SCISSORS .....	64	CAPSULAR FORCEPS GILL-ARRUGA .....	390	CHISELS MINI-LAMBOTTE .....	262
BREAST RETRACTOR .....	198	CAPSULAR FORCEPS HESS .....	391	CHISELS NOVOTEX .....	264
BREISKY VAGINAL SPECULA .....	577	CAPSULAR FORCEPS KALT .....	391	CHISELS OBWEGESER .....	463
BREITEN-MEASURING INSTRUMENT .....	594	CAPSULAR FORCEPS SCHWEIGER .....	391	CHISELS SMITH-PETERSEN .....	261
BRIDGE HEMOSTATIC CLAMP .....	116	CAPSULAR FORCEPS TERSON .....	391	CHISELSBLADE .....	266
BRISTOW BONE LEVERS .....	290	CAPSULAR GRASPING FORCEPS MILLIN .....	551	CHISELSSTILLE .....	260
BRISTOW BONE LEVERS .....	290	CARDIOVASCULAER CLAMP .....	526	CILIA FORCEPS BARRAQUER .....	395
BRODIE PROBES .....	199	CARMALT SPLINTER TISSUE FORCEPS .....	91	CILIA FORCEPS BEER .....	395
BRONCHO.FORCEPS CHEVALIER-JACK .....	473	CAROLL TENDON GRASPING INSTRUMENT .....	293	CILIA FORCEPS DOUGLAS .....	395
BRONCHUS CLAMP .....	126	CAROTIS-SHUNT CLAMP JAVID .....	511	CILIA FORCEPS GRADLE .....	395
BRONCHUSCLAMP FINOCCHIETTO .....	490	CARPENTER TONSIL KNIVES .....	465	CILIA FORCEPS LITTAUER .....	395
BRONCHUSCLAMP HARRINGTON .....	490	CARTILAGE KNIVES .....	47	CILIA FORCEPS REDA .....	395
BRONCHUSCLAMP LEES .....	504	CASPAR HEMOSTATS .....	258	CINELLI SEPTUM CHISELS .....	441
BRONCHUSCLAMP PRICE-THOMAS .....	490	CASPAR RETRACTORS .....	179, 180	CIRCULAR RONGEUR .....	432
BRONCHUSCLAMP SEMB .....	491	CASTANEDA NEONATAL VASCULAR CLAMP .....	527	CIRCUMCISIONS INSTRUMENT .....	556
BROPHY ANATOMIC TISSUE FORCEPS .....	84	CASTROVIEJO PROBE .....	381	CITELLI RONGEUR .....	430
BROPHY SURGICAL TISSUE FORCEPS .....	84	CASTROVIEJO BLADEBREAKER .....	45	CIRCLAMP VASEKTOMIE .....	553/2
BROWN NEEDLE HOLDER .....	209	CASTROVIEJO CAPSULAR FORCEPS .....	391	CLAMPHOLDING .....	326
BROWN TISSUE FORCEPS .....	83	CASTROVIEJO CYCLODIALYSIS SPATULA .....	379	CLARK HEAD LIGHTS .....	22
BRUENINGS .....	468, 472	CASTROVIEJO DISCISION KNIVES .....	372	CLARK EYE SPECULA .....	370
BRUENINGS EAR SPECULA .....	401	CASTROVIEJO EYE SPECULA .....	371	CLAUS TONSIL NEEDLE .....	466
BRUENINGS INTERCHANGEABLE TIPS .....	472	CASTROVIEJO FIXATION FORCEPS .....	390	CLAYMAN .....	376
BRUENINGS SEPTUM FORCEPS .....	425	CASTROVIEJO HORNYSKINSCISSORS .....	79	CLAYMAN HOOK .....	376
BRUENINGS TONGUE DEPRESSORS .....	451	CASTROVIEJO MEASURANCE CIRCLE .....	380	CLEANING PISTOL .....	626
BRUENINGS TONSIL-KNIVES .....	466	CASTROVIEJO NEEDLE HOLDER .....	215	CLEVELAND BONE RONGEUR .....	235
BRUNETTI CHISELS .....	268	CASTROVIEJO TISSUE FORCEPS .....	392	CLIP FORCEPS CHILDE .....	224
BRÜNING-S-LUCAS CHISELS .....	260	CASTROVIEJO-MICRO NEEDLE HOLDER .....	215	CLIP FORCEPS COLLIN .....	224
BRUNNER BOWEL CLAMP .....	543	CASTROVIEJO-STANDARD NEEDLE HOLDER .....	216	CLIP FORCEPS MICHEL .....	224
BRUNNER GUIDEPROBES .....	221	CATARACT CURETTE DAVIEL .....	377	CLIP FORCEPSRICHTER-HEATH .....	224
BRUNNER GUIDEPROBES .....	221	CATARACT CURETTE GRAEFE .....	377	CLIP MICHEL .....	224
BRUNNER RETRACTOR .....	167	CATARACT CURETTE KNAPP .....	378	CLIP TISSUE FORCEPS HEGENBARTH .....	224



CLIP TISSUE FORCEPS MICHEL.....	224	COTTLE FIXATION FORCEPS.....	410	D	
CLIP TISSUE FORCEPS WACHENFELDT.....	224	COTTLE HAMMER.....	273	DANDY HEMOSTATIC CLAMP.....	109
CLIP-APPLIER FORCEPS.....	523, 524	COTTLE NOSE HOOK.....	447, 447/1	DANDY NERVE HOOK.....	328
CLOWARD LAMINA SPREADER.....	339	COTTLE NOSE SCISSORS.....	59	DARLING RETRACTORS.....	178
CLOWARD LAMINECTOMY RETRACTOR FORCEPS.....	342	COTTLE NOSE SPECULA.....	423	DARTIGUES UTERINE-GRASPING FORCEPS.....	585
CLOWARD RETRACTORS.....	178	COTTLE SCISSORS.....	56	DASTOOR STRABISMUS FORCEPS.....	386
COAKLEY ANTRUM CURETTE.....	449	COTTLE SEPTUM CHISELS.....	440	DASTOOR SUCTION TUBE.....	380
COAKLEY TROCAR.....	204	COTTLE SEPTUM ELEVATOR.....	439	DAUBENSPECK BONE CURETTES.....	255
COBB CURETTE.....	252	COTTLE SEPTUM KNIVES.....	435	DAVIDSON(SCAPULA) RETRACTOR.....	166
COBB GOUGES.....	262	COTTLE SKIN HOOK.....	447, 448	DAVIEL CATARACT CURETTE.....	377
COBB RASPATORIES.....	280	COTTLE-JOSEPH SEPTUM.....	439	DAVIS BRAIN SPATULA.....	337
COLCLOUGH INTERVERTEBRAL DISC RONGEUR.....	344/1	COTTLE-KAZANJIAN BONE CUTTING FORCEPS.....	241	DAVIS DURA DISSECTOR.....	379
COLD LIGHT GUIDE HOLLINGER.....	37	COTTLE-NEIVERT.....	448	DAVIS FOREIGN-BODY NEEDLE.....	374
COLD LIGHT GUIDE JACKSON.....	37	COTTON-APPLICATOR.....	230	DAVIS STERILIZATION TISSUE FORCEPS.....	227
COLD LIGHTCLAMP FOR AMNIOSCOPE.....	601	COTTON-APPLICATOR FARRELL.....	203	DAVIS-BOYLE.....	455
COLLER-CRILE HEMOSTATIC CLAMP.....	106	COTTON-APPLICATOR JOBSON-HORNVE.....	203	DAVIS-BOYLE SPERRE.....	455
COLLIER NEEDLE HOLDER.....	208	COTTON-APPLICATOR REDA.....	203	DAVIS-MEYER MOUTH GAG.....	457
COLLIER PELVIMETER.....	605	COTTON-APPLICATOR TOBOLD.....	203	DAY HOOK.....	409
COLLIN ABDOMINALRETRACTORS.....	190	COTTON-APPLICATOR UCKERMANN.....	203	DE BAKEY NEEDLE HOLDER.....	210
COLLIN BOWEL GRASPING FORCEPS.....	539	COXETER METAL CATHETER.....	555	DE BAKEY VASCULAR CLAMP.....	494
COLLIN CLIP FORCEPS.....	224	CRAFOOD-SELLORS HEMOSTATIC CLAMP.....	118	DE BAKEY VASCULAR CLAMP.....	495
COLLIN DRESSINGFORCEPS.....	137	CRAFOOD HEMOSTATIC CLAMP.....	118	DE BAKEY VASCULAR SCISSORS.....	60, 61
COLLIN DYNAMOMETER.....	25	CRAFOOD LUNG SCISSORS.....	65/2	DE BAKEY VASCULAR-DILATOR.....	529
COLLIN HAMMER.....	270	CRANIPLAST BRAUN.....	607	DE BOER RIB SPREADER.....	486
COLLIN LOKTITE ABDOMINALDE.....	191	CRANIPLAST TARNIER.....	607	DE LEE OBSTETRICAL FORCEPS.....	602
COLLIN NAVELSTRINGCLAMP.....	605	CREGO ELEVATOR.....	282	DE MARTEL GUIDE SLEEVE.....	330
COLLIN PELVIMETER.....	605	CRILE HEMOSTATIC CLAMP.....	107	DE MARTEL-WOLFSON.....	546
COLLIN RETRACTOR.....	139	CRILE NEEDLE HOLDER.....	213	DEAN IRIS KNIVES.....	372
COLLIN SCALPEL-HANDLE.....	40	CRILE NERVE HOOK.....	328	DEAN TONSIL SCISSORS.....	59
COLLIN TISSUE GRASPING FORCEPS.....	110	CRILE RETRACTOR.....	140	DEAVER DISSECTING SCISSORS.....	52
COLLIN TONGUE FORCEPS.....	453	CRILE-MURRAY NEEDLE HOLDER.....	209	DEAVER RETRACTOR.....	145
COLLIN UTERINE-GRASPING FORCEPS.....	585	CRILE-RANKIN HEMOSTATIC CLAMP.....	107	DEAVER-GRIP RETRACTOR.....	146
COLLIN UTERINE-PROBES.....	585	CRILE-WOOD NEEDLE HOLDER.....	209	DEBAKEY AORTIC-ANAST.CLAMP.....	505
COLLIN VAGINAL SPECULA.....	570	CRITCHETT EYE SPECULA.....	370	DEBAKEY ATRAUMA BULLDOG CLAMP.....	100, 103
COLLIN-DUVAL GRASPING PINZE.....	85	CROWN SCISSORS BEEBEE.....	68	DEBAKEY ATRAUMA CLAMP.....	100
COLLIN-HARTMANN RETRACTOR.....	141	CRUTCHFIELD HEAD HOLDER.....	327	DEBAKEY ATRAUMA CLAMP.....	103
COLUMELLA TISSUE FORCEPS COTTLE.....	448	CRUTCHFIELD CERVICAL TRACTION TONG.....	327	DEBAKEY ATRAUMATIC TISSUE FORCEPS.....	99
COLVER TONSIL FORCEPS.....	467	CUFF FOR LEG.....	295	DEBAKEY RETRACTOR.....	189/1
COMEDONE EXTRACTOR SAALFELD.....	608	CUFF FOR UPPER ARM.....	295	DEBAKEY SUCTION TUBE.....	28
COMEDONE EXTRACTOR SCHAMBERG.....	608	CULLER IRIS SPATULA.....	378	DEBAKEY VASCULAR CLAMP.....	507, 514, 515, 516
COMEDONE EXTRACTOR UNNA.....	608	CUP MEDICINE.....	621	DEBAKEY VASCULAR SCISSORS.....	61
COMEDONE EXTRACTOR WALTON.....	608	CUP SPUTUM.....	621	DEBAKEY VASCULAR SCISSORS TC.....	60
COMPRESSION BANDAGE.....	296	CURETTE ANTRUM.....	435	DEBAKEY-BAHNSON ANEURYSM CLAMP.....	506
CONE CURETTE.....	280	CURETTE COBB.....	252	DEBAKEY-DIETHRICH MINI BULLDOG CLAMP.....	101
CONE HEAD PUNCH.....	331	CURETTE FAULKNER.....	449	DEBAKEY-MOSQUITO HEMOSTATIC CLAMP.....	509
CONE RASPATORIES.....	280	CURETTE FORCEPS.....	416	DEBAKEY-PEAN ATRAUMA CLAMP.....	513
CONNIN-AMSLER MARKERS.....	380	CURETTE HOUSE.....	420	DEBAKEY-RANKIN ATRAUMA CLAMP.....	512
CONVERSE NOSE HOOK.....	448	CUSCO VAGINAL SPECULA.....	570	DECAPITATING HOOK BRAUN.....	607
CONVERSE SEPTUM KNIVES.....	435	CUSHING (TAYLOR) TISSUE FORCEPS TC.....	87	DEJERINE PERCUSSION HAMMER.....	24
COOLEY ANASTOMOSIS CLAMP.....	519, 520	CUSHING ANATOMIC TISSUE FORCEPS.....	83	DELEE RETRACTOR.....	574
COOLEY AORTIC DILATOR.....	528	CUSHING BRAIN SPATULA.....	336, 369	DEMEE WIRE GUIDE NEEDLE.....	315
COOLEY CATHETER FORCEPS.....	510	CUSHING DRILL.....	299	DEMEE WIRE INSTRUMENT.....	315
COOLEY RETRACTOR.....	148	CUSHING LAMINECTOMY RETRACTOR FORCEPS.....	340	DENHART MOUTH GAGS.....	454
COOLEY RIB SPREADER.....	487	CUSHING NERVE ENHOOK.....	328	DENIS-BROWNE ABDOMINALRETRACTORS.....	186
COOLEY VASCULAR CLAMP.....	518, 522	CUSHING RETRACTOR.....	152	DERF NEEDLE HOLDER.....	208
COOLEY-DERRA ANASTOMOSIS CLAMP.....	519	CUSHING RETRACTOR.....	153	DERMATOM HUMBY.....	50
COOLEY-NEONATAL RIB SPREADER.....	485	CUSHING RETRACTOR.....	151, 152, 153	DERMATOM SILVER.....	50
COOLY SUCTION TUBE.....	28	CUSHING SURGICAL TISSUE FORCEPS.....	83	DERMATOME SCHINK.....	49
COOPER LIGATUREE NEEDLE.....	219	CUSHING TISSUE FORCEPS.....	87	DERMATOME BLADE.....	49
CORDES INTERCHANGEABLE TIPS.....	472	CUSHING-TAYLOR ANATOMIC TISSUE FORCEPS.....	87	DESCHAMPS LIGATUREE NEEDLE.....	218
CORNEAL DISSECTOR GREEN.....	374	CUZZI OVUM CURETTE.....	606	DESJARDINS GALL STONE.....	532
CORNEAL DISSECTOR PATON.....	373	CYCLODIALYSIS SPATULA BANGERTER.....	379	DESJARDINS GALL STONE CURETTE.....	534
CORNEAL SCARIFIER ELSCHNIG.....	373	CYCLODIALYSIS SPATULA CASTROVIEJO.....	379	DESJARDINS GALL STONE FORCEPS.....	531
CORNEAL SCARIFIER GILL.....	373	CYCLODIALYSIS SPATULA ELSCHNIG.....	379	DESJARDINS HEMOSTATIC CLAMP.....	121
CORNEAL SCARIFIER SATO.....	373	CYCLODIALYSIS SPATULA WHEELER.....	379	DESMARRES CHALAZIO TISSUE FORCEPS.....	393
CORNEAL SCARIFIER TOOK.....	373	CYSTOTOM BECKER.....	375	DESMARRES RETRACTOR.....	151
CORNEAL SCLEROTOME KUHNT.....	373	CYSTOTOM GRAEFE.....	375	DEUTSCHMANN CATARACT KNIVES.....	371
CORONAL BROW RETRACTOR.....	198	CZERNY HOOK FORCEPS.....	584	DEVILBISS HEAD FORCEPS.....	332
CORWIN-HEGAR WIRE FORCEPS.....	319	CZERNY RECTAL-SPECULA.....	559	DIAGNOSTIC SET ECO "C".....	16
CORYLLOS RETRACTOR.....	166			DIAGNOSTIC SET ECO "T".....	16
CORYLLOS RIB SCISSORS.....	480			DIAGNOSTIC SET RI-MINI.....	17
COS MICRO-EAR FORCEPS.....	414			DIAGNOSTIC SET UNI III.....	15
COTTLE COLUMELLA TISSUE FORCEPS.....	448			DIEFFENBACH VASCULAR CLAMP.....	104

DIETER MICRO-EAR FORCEPS.....	414	DRESSINGFORCEPS FOERSTER.....	136	EARSYRINGE REINER.....	406
DIETRICH BLOOD VESSEL CLAMP.....	510	DRESSINGFORCEPS GROSS-MAIER.....	134	ECHLIN BONE RONGEUR.....	240
DIETRICH MINI-BULLDOG CLAMP.....	101	DRESSINGFORCEPS LISTER (SINUS).....	137	ECO "C" DIAGNOSTIC SET.....	16
DIETRICH VASCULAR SCISSORS.....	60	DRESSINGFORCEPS M.SPERRER.....	135	ECO "T" DIAGNOSTIC SET.....	16
DILATION BOUGIE DITTEL.....	554	DRESSINGFORCEPS MAIER.....	134	EICKEN (KILLIAN) IRRIGATION CANNULA.....	433
DILATION BOUGIE GUYON.....	554	DRESSINGFORCEPS PELKMANN.....	137	ELEVATOR ALDERDYCE.....	282
DILATION BOUGIE VAN BUREN.....	554	DRESSINGFORCEPS RAMPLEY.....	136	ELEVATOR BOIES.....	277
DINGMANN BONE HOLDING FORCEPS.....	246	DRESSINGFORCEPS SIMS-MAIER.....	134	ELEVATOR CREGO.....	282
DINGMANN MOUTH GAGS.....	456	DRESSINGFORCEPS ULRICH.....	135	ELEVATOR DINGMANN.....	463, 463/3
DINGMANN RASPTORIES.....	463	DRESSINGTISSUE FORCEPS JACKSON.....	471	ELEVATOR KEY.....	282
DINGMANN RETRACTOR.....	463	DRILL.....	299	ELEVATOR LEMPERT.....	420
DINGMANN SPREADER.....	456	DRILL BITS.....	302	ELEVATOR LUNIATSCHEK.....	465
DIPLOMAT SPHYGMOMANOMETER.....	5	DRILL CUSHING.....	299	ELEVATOR MCDONALD.....	283
DISCISION KNIVES BERENS.....	372	DRILL ERRICO.....	299	ELEVATOR MURPHY-LANE.....	283
DISCISION KNIVES BOWMAN.....	372	DRILL MC KENZIE.....	299	ELEVATOR SAYRE.....	281
DISCISION KNIVES CASTROVIEJO.....	372	DRILL SUPPORT.....	310	ELEVATOR WATSON-CHEVNE.....	283
DISCISION KNIVES JAEGER.....	372	DRILL WIRE.....	299	ELEVATORIUM FREER.....	434
DISCISION KNIVES WHEELER.....	373	DRILLWIRE KIRSCHNER.....	306, 307	ELLIOT OBSTETRICAL FORCEPS.....	602
DISCISION KNIVES ZIEGLER.....	373	DRIVER KUENTSCHER.....	321	ELLIS FOREIGN-BODY GOUGES.....	374
DISCISION NEEDLE.....	374	DRIVERS.....	321	ELSCHING CAPSULAR FORCEPS.....	391
DISCISION NEEDLE BOWMAN.....	374	DUBOIS GYNECOLOGICAL SCISSORS.....	63	ELSCHING CORNEAL SCARIFIER.....	373
DISSECTING SCISSORS.....	52	DUEHRSEN ANATOMIC TISSUE FORCEPS.....	84	ELSCHING CYCLODIALYSIS SPATULA.....	379
DISSECTING SCISSORS.....	53/2	DUPLAY DRESSINGFORCEPS.....	134	ELSCHING FIXATION FORCEPS.....	389
DISSECTING SCISSORS DEAVER.....	52	DUPLAY HOOK FORCEPS.....	582	EMMETT FISTULA HOOK.....	594
DISSECTING SCISSORS JORGENSEN.....	53	DUPLEX STETHOSCOPE.....	23	ENDERNAIL STEINMANN.....	307
DISSECTING SCISSORS LEXER.....	53	DUPUY-WEISS TONSIL KNIVES.....	466	ENDOSCOPE ASSEMBLY.....	188
DISSECTING SCISSORS LEXER-BABY.....	53	DURA DISSECTOR.....	332	ENDOSCOPE WIREBASKET.....	623
DISSECTING SCISSORS LEXER-BABY TC.....	53	DURA DISSECTOR DAVIS.....	332	ENDOSPECULA KOGAN.....	577
DISSECTING SCISSORS MAYO.....	52	DURA DISSECTOR FRAZIER.....	333	ENGEL PLASTER CAST SAW.....	229
DISSECTING SCISSORS MAYO TC.....	52	DURA DISSECTOR HOEN.....	333	ENTEROTOMY SCISSORS.....	66
DISSECTING SCISSORS MAYO-NOBLE.....	52	DURA DISSECTOR HORSLEY.....	333	ENTROPIUM FORCEPS SNELLEN.....	393
DISSECTING SCISSORS MAYO-STILLE.....	52	DURA DISSECTOR MILLIGAN.....	332	ENUCLATION CURETTE WELLS.....	378
DISSECTING SCISSORS MAYO-STILLE.....	52	DURA DISSECTOR OLIVECRONA.....	332	ENUCLATION SCISSORS.....	58
DISSECTING SCISSORS MAYO-STILLE TC.....	52	DURA DISSECTOR SACHS.....	332	EPIGLOTTIS RETRACTOR FRAENKEL.....	471
DISSECTING SCISSORS METZENBAUM.....	53/1	DURA DISSECTOR TOENNIS.....	332	EPIGLOTTIS RETRACTOR JACKSON.....	471
DISSECTING SCISSORS METZENBAUM.....	53/1	DURA DISSECTOR WOODSON.....	333	EPIGLOTTIS RETRACTOR REICHERT.....	471
DISSECTING SCISSORS METZENBAUM FINO.....	53/1	DURA HOOK.....	335	EPISOTOMY SCISSORS WALDMANN.....	64
DISSECTING SCISSORS METZENBAUM TC.....	53/1	DURA HOOK JACOBSON.....	335	EPKER OSTEOTOME.....	464/2
DISSECTING SCISSORS PECK-JOSEPH.....	74	DURA KNIVES KOOS.....	335	EPPENDORFER BIOPSY FORCEPS.....	590
DISSECTING SCISSORS TOENNIS-ADSON.....	65	DURAHOOK ADSON.....	328	ESMARCH BANDAGE SCISSORS.....	69/2
DISSECTING SCISSORSMETZENBAUM FINO TC.....	53/1	DURANTE GRASPING TISSUE FORCEPS.....	88	ESMARCH PLASTER KNIVES.....	233
DISSECTOR FISCH.....	420	DURASCISSORS SCHMIEDEN-TAYLOR.....	65/1	ETHICON CLIP FORCEPS.....	524
DISSECTOR GORNEY.....	277	DUVAL BOWEL GRASPING FORCEPS.....	539	EYES TONSIL SNARE.....	468
DISSECTOR PENFIELD.....	333	DYVAL GRASPING TISSUE FORCEPS.....	85	EXACTA SPHYGMOMANOMETER.....	8
DITTEL DILATION BOUGIE.....	554	DYNAMOMETER COLLIN.....	25	EXANTERATION CURETTE BUNGE.....	378
DIX FOREIGN-BODY CHISELS.....	374	E.....		EXTENSIONS BOWS BOEHLER.....	312
DIX FOREIGN-BODY INSTRUMENT.....	380	EAR CATHETER HARTMANN.....	408	EXTENSIONS BOWS KIRSCHNER.....	312
DOUBLECURETTE VOLKMAN.....	257	EAR CURETTE BUCK.....	407	EXTENSIONS BOWS KIRSCHNER US.....	312
DOUGHTY TONGUE BLADE.....	458	EAR CURETTE GROSS.....	409	EXTIRPATIONSCHISELS ROLLET.....	374
DOUGLAS CILIA FORCEPS.....	395	EAR FORCEPS HARTMANN.....	411	EXTRACTION DISSECTOR LANG.....	378
DOUGLAS TONSIL KNIVES.....	466	EAR FORCEPS HEYMANN-KNIGHT.....	425	EXTRACTION HOOK.....	322
DOUGLAS TROCAR.....	205	EAR FORCEPS JANSEN.....	424	EXTRACTION HOOK KNAPP.....	375
DOYEN ABDOMINALRETRACTORS.....	189/1	EAR FORCEPS JANSEN.....	424	EXTRACTION HOOK ROLLET.....	375
DOYEN BOWEL CLAMP.....	540	EAR FORCEPS LITTAUER.....	411	EXTRACTION HOOK ARRUGA.....	375
DOYEN GYNECOLOGICAL SCISSORS.....	63	EAR FORCEPS LUCAE.....	410	EXTRAKTOR KUENTSCHER.....	322
DOYEN MYOMA A SCREW.....	594	EAR FORCEPS TILLEY.....	411	EYE CANNULA MCINTYRE.....	394
DOYEN PROBES.....	199	EAR FORCEPS TROELTSCH.....	424	EYE CANNULA TYPE AIR INJECTION.....	394
DOYEN RASPTORIES.....	278	EAR FORCEPS WILDE (TROELTSCH).....	410	EYE CANNULA TYPE SHEETS.....	394/2
DOYEN RETRACTOR.....	163	EAR KNIVES POLITZER.....	408	EYE MAGNET REDA.....	395
DOYEN SCISSORS.....	63	EAR KNIVES SEXTON.....	408	EYE SPECULA ARRUGA.....	370
DOYEN TOWEL CLAMP.....	133	EAR LEVER ZAUFAL.....	409	EYE SPECULA BARRAQUER.....	370
DOYEN UTERINE POLYP FORCEPS.....	585	EAR LEVER ZAUFAL-JANSEN.....	409	EYE SPECULA BOWMAN.....	370
DOYEN VAGINAL SPECULA.....	574	EAR LOOP BILLEAU.....	409	EYE SPECULA CASTROVIEJO.....	371
DOYEN-BABY BOWEL CLAMP.....	540	EAR LOOP SHAPLEIGH.....	410	EYE SPECULA CLARK.....	370
DOYEN-JANSEN(MOLT).....	454	EAR SPECULA BOUCHERON.....	399	EYE SPECULA CRITCHETT.....	370
DOYEN-JANSEN(MOLT) MOUTH GAGS.....	454	EAR SPECULA BRUENINGS.....	401	EYE SPECULA GRAEFEE.....	370
DOYEN-STILLE RETRACTOR.....	167	EAR SPECULA GRUBER.....	399	EYE SPECULA LANCASTER.....	371
DRESSINGFORCEPS.....	135	EAR SPECULA HARTMANN.....	399	EYE SPECULA LISTER-BURCH.....	370
DRESSINGFORCEPS BOZEMANN.....	138	EAR SPECULA POLITZER.....	399	EYE SPECULA MELLINGER.....	370
DRESSINGFORCEPS BOZEMANN-DOUGLAS.....	138	EAR SPECULA RICHNAU-HOLMGREN.....	400	EYE SPECULA MELLINGER-AXENFELD.....	370
DRESSINGFORCEPS BRYANT.....	137	EAR SPECULA SIEGLE.....	402	EYE SPECULA MUELLER.....	371
DRESSINGFORCEPS CHERON.....	137	EAR SPECULA TOYNBEE.....	399	EYE SPECULA MURDOCK.....	370
DRESSINGFORCEPS COLLIN.....	137	EARPROBESSTACKE.....	199	EYE SPECULA PARK.....	371

EYE SPECULA SMITH .....	370	FIXATION FORCEPS LESTER .....	389	GASS HOOK .....	376		
EYE SPECULA WEEK .....	370	FIXIERFORC BURCH .....	373	GAUSS KOPFSCHWARTE .....	605		
EYE SPECULA WILLIAMS .....	370	FIXIERVORRICHTUNG ROCHARD .....	186	GELPI ABDOMINALRETRACTORS .....	189/1, 189/2		
EYE SPECULA ZIEGLER .....	371	FLAT FORCEPS .....	316, 317	GELPI HOOK .....	193		
EYE SPECULAST.EVENSON .....	371	FOERSTER DRESSINGFORCEPS .....	136	GEMINI HEMOSTATIC CLAMP .....	115		
EYE SUCTION -IRRIGATION CANNULA .....	394	FOERSTER IRIS TISSUE FORCEPS .....	383	GERALD ANATOMIC TISSUE FORCEPS .....	86		
EYESSCISSORS BARRAQUER .....	75	FOMON NOSE RASP .....	444	GERALD SURGICAL TISSUE FORCEPS .....	87		
EYESSCISSORS NOYES .....	75	FOMON NOSE SCISSORS .....	58	GERSTER BONE HOLDING CLAMP .....	250		
EYESSCISSORS VANNAS .....	79	FOMON RASPORITIES .....	277	GERZOG HAMMER .....	270		
EYESSCISSORS WECKER .....	75	FOMON RHINOPLASTSCISSORS .....	65/1	GIERTZ-STILLE RIB SCISSORS .....	481		
EYESSCISSORS WESTCOTT .....	75	FOMON SEPTUM CHISELS .....	441	GIGLI SAW .....	332		
<b>F</b>						GILL CORNEAL SCARIFIER .....	373
FACE LIFT SCISSORS FREEMAN .....	74	FOMON TC NOSE RASP .....	445	GILL IRIS TISSUE FORCEPS .....	384		
FACE LIFT SCISSORS GORNEY .....	73	FOREGGER LARYNGOSCOPI .....	29, 31	GILL-ARRUGA CAPSULAR FORCEPS .....	390		
FACE LIFT SCISSORS KAYE .....	73	FOREIGN-BODY CHISELS DIX .....	374	GILL-HESS IRIS TISSUE FORCEPS .....	384		
FACE LIFT SCISSORS REES .....	73	FOREIGN-BODY CURETTE ALVIS .....	374	GILLIES NEEDLE HOLDER .....	212		
FANSLER PROCTOSCOPE .....	564	FOREIGN-BODY FORCEPS HARTMANN .....	412	GILLIES SKIN HOOK .....	448		
FARABEUF BONE HOLDING FORCEPS .....	243	FOREIGN-BODY FORCEPS HARTMANN-HOFFMANN .....	412	GILLIES SURGICAL TISSUE FORCEPS .....	86		
FARABEUF RASPORITIES .....	274	FOREIGN-BODY FORCEPS HARTMANN-WULLSTEIN .....	412	GIL-VERNET RETRACTOR .....	152		
FARABEUF RETRACTOR .....	139	FOREIGN-BODY FORCEPS MATHIEU .....	553/1	GLOVER ATRAUMA CLAMP .....	100		
FARABEUF-COLLIN RASPORITIES .....	274	FOREIGN-BODY GOUGES ELLIS .....	374	GLOVER BULLDOG CLAMP .....	103		
FARABEUF-LAMBOTTE BONE HOLDING FORCEPS .....	243	FOREIGN-BODY GOUGES WALTON .....	374	GLOVER VASCULAR CLAMP .....	515		
FARRELL COTTON-APPLICATOR .....	203	FOREIGN-BODY INSTR. DIX .....	380	GLUCK RIB SCISSORS .....	480		
FARRIOR EAR SPECULA .....	400	FOREIGN-BODY LEVER BUCK .....	412	GOELET RETRACTOR .....	141		
FARRIOR EAR SPECULA .....	400	FOREIGN-BODY LEVER QUIRE .....	412	GOLDMANN-FOX GUMSCISSORS .....	67		
FAULKNER CURETTE .....	449	FOREIGN-BODY NEEDLE .....	374	GOMEL MICROSURGICAL TISSUE FORCEPS .....	96		
FAURE BIOPSY FORCEPS .....	588	FOREIGN-BODY NEEDLE DAVIS .....	374	GOMMEL MICRO-SCISSORS .....	80		
FAURE PERITONEUMCLAMP .....	123	FOREIGN-BODY NEEDLE FRANCIS .....	374	GONIOMETER F. FINGER .....	25		
FAVALORO VASCULAR SCISSORS .....	61	FOREIGN-BODY NEEDLE LA FORCE .....	374	GONIOMETER MOELGTEN .....	25		
FEHLAND BOWEL CLAMP .....	542	FOREIGN-BODY NEEDLE LEVINSON .....	374	GONIOTOMY KNIVES BARKAN .....	373		
FEILCHENFELD TISSUE FORCEPS .....	91	FOX LUPUS CURETTE .....	608	GONIOTOMY KNIVES SCHEIE .....	373		
FELDHEIM BONE HOLDING CLAMP .....	249	FRAENKEL INTERCHANGEABLE TIPS .....	472	GOOD TONSIL SCISSORS .....	59		
FERGUSSON BONE HOLDING FORCEPS .....	243	FRANCIS FOREIGN-BODY NEEDLE .....	374	GOODELL UTERINE DILATATOR .....	581		
FERGUSSON FRAZIER SUCTION TUBE .....	337	FRANKLIN-SILVERMANN BIOPSY NEEDLE .....	206	GORNEY DISSECTOR .....	277		
FERGUSSON GALL STONE CURETTE .....	533	FRAZIER ABDOMINALRETRACTORS .....	181	GORNEY FACE LIFT SCISSORS .....	73		
FERGUSSON HAEMORRHOIDALCLAMP .....	109	FRAZIER DURA DISSECTOR .....	333	GOSSET ABDOMINALRETRACTORS .....	181		
FERGUSSON SURGICAL SCISSORS .....	66	FRAZIER PUNCTION CANNULA .....	337	GOUGES .....	264		
FERRIERA RETRACTOR .....	197	FRAZIER SKIN HOOK .....	149	GOUGES PARTSCH .....	259		
FERRIS-SMITH LAMINECTOMY RETRACTOR FORCEPS .....	343	FREEMAN FACE LIFT SCISSORS .....	74	GOUGES COBB .....	262		
FERRIS-SMITH SURGICAL TISSUE FORCEPS .....	85	FREEMAN RETRACTOR .....	198	GOUGES HIBBS .....	265		
FERRIS-SMITH-KERRISON RONGEUR .....	344, 344/2	FREER ELEVATORIUM .....	434	GOUGES LEXER MINI .....	263		
FIBERGLAS-LIGHT GUIDE KLEINSASSER .....	36	FREER SEPTUM CHISELS .....	439, 442	GOUGES WEST .....	442/1		
FICHOCHIETTO-BABY RIB SPREADER .....	482	FREER SEPTUM ELEVATOR .....	437	GOUGES ZIELKE .....	264		
FILES BONE .....	612/1	FREER SEPTUM KNIVES .....	434	GOUGESSTILLE .....	260		
FINGER NAIL DRILL .....	297	FREER SKIN HOOK .....	448	GOURDET UTERINE CURETTE .....	599		
FINGER PROTECTOR LANGENBECK .....	311	FRENZEL NYSTAGMUS SPECTACLES .....	20	GRADLE CILIA FORCEPS .....	395		
FINGER RING SAW REDA .....	297	FRENZEL TONGUE DEPRESSORS .....	451	GRADLE OPHTHALMOLOGIC SCISSORS .....	57		
FINGER RING SAW WALTON .....	297	FRIEDMANN MINI BONE RONGEUR .....	234	GRADUATED MEASURE .....	620		
FINGER-GONIOMETER .....	25	FRIEDMANN SPECULA .....	577	GRAEFE CATARACT CURETTE .....	377		
FINGERSAW LANGENBECK .....	296	FRIEDMANN SPECULA .....	577	GRAEFE CATARACT KNIVES .....	371		
FINOCCHIETTO BRONCHUSCLAMP .....	490	FRIEHSCH RETRACTOR .....	163	GRAEFE CATARACT KNIVES .....	371		
FINOCCHIETTO RIB SPREADER .....	482	FRYKHOLM BONE RONGEUR .....	240	GRAEFE CYSTOTOM .....	375		
FINOCCHIETTO NEEDLE HOLDER .....	211	FUCHS CAPSULAR FORCEPS .....	391	GRAEFE DISCISION KNIVES .....	372		
FINOCCHIETTO RIB SPREADER .....	484	FUCHSIG HEMOSTATIC CLAMP .....	113	GRAEFE DISCISION KNIVES .....	372		
FINOCCHIETTO-BABY RIB SPREADER .....	482	FÜHR.PROBES BRUNNER .....	221	GRAEFE FIXATION FORCEPS .....	389		
FINOCCHIETTO-BURFORD RIB SPREADER .....	483	FÜHR.PROBES PAYR .....	221	GRAEFE IRIS TISSUE FORCEPS .....	382		
FINSER RETRACTOR .....	168	FÜHR.PROBES VIENNA .....	221	GRAEFE SCISSORS .....	56		
FISCH DISSECTOR .....	420	<b>G</b>				GRAEFE STRABISMUS HOOK .....	375
FISCH FINE HOOK .....	335	GALEAHOOK YASARGIL .....	330	GRAEFE TISSUE FORCEPS .....	83		
FISCHER IRIS TISSUE FORCEPS .....	384	GALL DUCT DILATOR BAKES .....	532	GRAEVE HOOK .....	149		
FISH PROBES .....	199	GALL STONE CURETTE DESJARDINS .....	534	GRAFFE EYE SPECULA .....	370		
FISHER TONSIL-KNIVES .....	466	GALL STONE CURETTE FERGUSSON .....	533	GRAHAM NERVE HOOK .....	328		
FISTULA HOOK EMMETT .....	594	GALL STONE CURETTE LUER-KOERTE .....	533	GRASPING FORCEPS .....	316		
FISTULA PROBES PRATT .....	563	GALL STONE CURETTE MAYO .....	534	GRASPING FORCEPS .....	415		
FISTULAPROBES LOCKHART-MUMMERY .....	200	GALL STONE CURETTE MOOR .....	532	GRASPING FORCEPS LAHEY .....	479		
FIXATION FORCEPS BARRAQUER .....	390	GALL STONE FORCEPS BLAKE .....	531	GRASPING FORCEPS MARTEL .....	110		
FIXATION FORCEPS CASTROVIEJO .....	390	GALL STONE FORCEPS DESJARDINS .....	531	GRASPING FORCEPS PRATT .....	110		
FIXATION FORCEPS COTTLE .....	410	GALL STONE FORCEPS MAYO-BLAKE .....	531	GRASPING FORCEPS WILLET MARTEL .....	110		
FIXATION FORCEPS ELSCHNIG .....	389	GALL STONE FORCEPS MIXTER .....	531	GRASPING TISSUE FORCEPS COLLIN-DUVAL .....	85		
FIXATION FORCEPS GRAEFE .....	389	GALL STONE PROBES DESJARDINS .....	532	GRASPING TISSUE FORCEPS DURANTE .....	88		
FIXATION FORCEPS GREEN .....	390	GALL STONE PROBES MAYO .....	534	GRASPING TISSUE FORCEPS DUVAL .....	85		
		GALL STONE PROBES MOYNIHAN .....	532	GRASPING TISSUE FORCEPS LERCHE .....	83		
		GALLAHER ANTRUM RASP .....	446	GRASPING TISSUE FORCEPS RUSS MODELL .....	85		
				GRAVE VAGINAL SPECULA .....	570		

GRAY HEMOSTATIC CLAMP.....	121	HARGIS AWL.....	463	HEMOSTATIC CLAMP LAHEY.....	120
GREEN CORNEAL DISSECTOR.....	374	HARGIS MANDIBULAR BODY RETRACTOR.....	463/6	HEMOSTATIC CLAMP LAWRENCE.....	119
GREEN FIXATION FORCEPS.....	390	HARGIS RASPATORY.....	463/2	HEMOSTATIC CLAMP LERICHE.....	111
GREEN MUSCLE HOOK.....	375	HARKEN AURIKELCLAMP.....	503	HEMOSTATIC CLAMP LOVEFACE.....	109
GREEN RETRACTOR.....	160	HARMS LACHRYMAL PROBES.....	381	HEMOSTATIC CLAMP LOWER.....	120
GREEN-ARMYTAGE.....	605	HARMS PROBES.....	333	HEMOSTATIC CLAMP MAYO-GUYON.....	122
GREVEN MICRO-EAR FORCEPS.....	414	HARRINGTON BRONCHUSCLAMP.....	490	HEMOSTATIC CLAMP MEEKER.....	119
GROSS EAR CURETTE.....	409	HARRINGTON HOOK.....	193	HEMOSTATIC CLAMP MICRO-HARTMANN.....	104
GROSS-MAIER DRESSINGFORCEPS.....	134	HARRINGTON -PEMBERTON RETRACTOR.....	147	HEMOSTATIC CLAMP MIXER.....	119, 121
GRUBER EAR SPECULA.....	399	HARRINGTON RETRACTOR.....	147	HEMOSTATIC CLAMP MIXER-BABY.....	119
GUIDE DRIVER.....	321	HARTMANN EAR CATHETER.....	408	HEMOSTATIC CLAMP MOYNIHAN.....	121
GUIDE NEEDLE REDON.....	207	HARTMANN EAR SPECULA.....	399	HEMOSTATIC CLAMP O'SHAUGHNESSY.....	120
GUIDEPROBES KÖNIG.....	221	HARTMANN FOREIGN-BODY FORCEPS.....	412	HEMOSTATIC CLAMP OVERHOLT.....	114
GUIDEPROBES BRUNNER.....	221	HARTMANN FOREIGN-BODY LEVER.....	411	HEMOSTATIC CLAMP PEAN.....	108
GUIDEPROBES KIRSCHNER.....	221	HARTMANN HEMOSTATIC CLAMP.....	104	HEMOSTATIC CLAMP PEAN.....	110
GUIDEPROBES SCHMIEDEN.....	221	HARTMANN IRRIGATION CANNULA.....	433	HEMOSTATIC CLAMP PENNINGTON.....	109
GUIDEPROBES SCHMIEDEN-PAYR.....	221	HARTMANN NOSE SPECULA.....	422, 427	HEMOSTATIC CLAMP PROVIDENCE-HOSPITAL.....	106
GUILLEN SUCTION RASPATORIES.....	433/1	HARTMANN POLYP FORCEPS.....	424	HEMOSTATIC CLAMP ROBERTS.....	117
GUM SCISSORS LA GRANGE.....	69	HARTMANN TONGUE DEPRESSORS.....	452	HEMOSTATIC CLAMP ROCHESTER-CARMALT.....	109
GUMSCISSORS GOLDMAN-FOX.....	67	HARTMANN TUNING FORC.....	403	HEMOSTATIC CLAMP ROCHESTER-OCHSNER.....	108
GUMSCISSORS LOCKLIN.....	69	HARTMANN-HALLE NOSE SPECULA.....	421	HEMOSTATIC CLAMP ROCHESTER-PEAN.....	108
GUMSCISSORS QUINBY.....	67	HARTMANN-HOFFMANN FOREIGN-BODY FORCEPS.....	412	HEMOSTATIC CLAMP RUMEL.....	117
GUTHRIE SKIN HOOK.....	149	HARTMANN-WULLSTEIN FOREIGN-BODY FORCEPS.....	412	HEMOSTATIC CLAMP SAROT.....	118
GUYON CATHETER EINGUIDE.....	554	HAUGH MICRO-EAR FORCEPS.....	414	HEMOSTATIC CLAMP S-CVD MIXTER.....	116
GUYON DILATION BOUGIE.....	554	HAYES RECTUM-ANAST.KL.....	545	HEMOSTATIC CLAMP SPENCER-WELLS.....	109
GUYON HEMOSTATIC CLAMP.....	122	HEAD HOLDER CRUTCHFIELD.....	327	HEMOSTATIC CLAMP STILLE.....	122
GUYON KIDNEY CLAMP.....	122	HEAD LIGHTS CLAR KPLT.....	22	HEMOSTATIC CLAMP TOENNIS.....	117
GUYTON-LUNDGAARD SKLEROTOM.....	373	HEAD MIRRORS ZIEGLER.....	21	HEMOSTATIC CLAMP WIKSTROEM.....	117
GYNECOLOGICAL SCISSORS DOYEN.....	63	HEAD PUNCH CONE.....	331	HEMOSTATIC CLAMP ZENKER.....	118
GYNECOLOGICAL SCISSORS DUBOIS.....	63	HEANEY HYSTERECTOMYCLAMP.....	126	HEMOSTATIC CLAMPOVERHOLT-BABY.....	114
GYNECOLOGICAL SCISSORS SIEBOLD.....	62	HEANEY NEEDLE HOLDER.....	210	HEMOSTATIC CLAMPOVERHOLT-GEISSENDÖRFER.....	114
GYNECOLOGICAL SCISSORS SIMS.....	62	HEANY BIOPSY CURETTE.....	587	HEMOSTATIC CLAMPOVERHOLT-MIXTER.....	115
GYNECOLOGICAL SCISSORS WERTHEIM.....	63	HEANY RETRACTOR.....	164	HEMOSTATS.....	259
H.....		HEANY-BALLENTINE HYSTERECTOMYCLAMP.....	127	HENKE TONSIL-ELEVATOR.....	465
HABERER BOWEL SPATULA.....	143/1	HEATH HAMMER.....	273	HENLEY RETRACTORS.....	170
HAEMORRHOIDAL LIGATOR MC GIVNEY.....	568	HEATH SUTURE SCISSORS.....	66	HENNIG PLASTER RETRACTOR.....	232
HAEMORRHOIDALCLAMP FERGUSSON.....	109	HEBRA CHALAZIO CURETTE.....	377	HEPP-SCHEIDEL MICRO-SCISSORS.....	78
HAEMORRHOIDALFORCEPS HEYWOOD-SMITH.....	567	HEGAR UTERINE DILATOR.....	578, 579	HERRICK NIERENSTIELCLAMP.....	123
HAGLUND-STILLE PLASTER RETRACTOR.....	232	HEGENBARTH CLIP TISSUE FORCEPS.....	224	HESS CAPSULAR FORCEPS.....	391
HAIGHT RIB SPREADER.....	487	HEIFETZ BRAIN SPATULA.....	369	HESS IRIS TISSUE FORCEPS.....	384
HAJEK HAMMER.....	273	HEIMING KIDNEY STONE FORCEPS.....	536	HEYMANN SEPTUM FORCEPS.....	425
HAJEK SEPTUM CHISELS.....	442/1	HEISS HEMOSTATIC CLAMP.....	112	HEYMANN NOSE SCISSORS.....	58
HAJEK-BALLENGER ELEVATOR.....	439	HEISTER MOUTH GAGS.....	454	HEYMANN-KNIGHT EAR FORCEPS.....	425
HAJEK-KOFLER RONGEUR.....	429, 431	HEMOSTATIC CLAMP ADSON.....	112	HEYWOOD-SMITH HAEMORRHOIDAL FORCEPS.....	567
HALLE BONE CURETTES.....	253	HEMOSTATIC CLAMP ADSON-BABY.....	113	HIBBS CHISELS.....	265
HALLE SEPTUM ELEVATOR.....	437	HEMOSTATIC CLAMP BAINBRIDGE.....	120	HIBBS GOUGES.....	265
HALOGEN LAMP FOR LARYNGOSCOPE.....	29	HEMOSTATIC CLAMP BENGOLEA.....	112	HIBBS RETRACTOR.....	164
HALSEY NEEDLE HOLDER.....	208	HEMOSTATIC CLAMP BIRKETT.....	116	HILL-FERGUSSON RECTAL-SPECULA.....	560
HALSTED-MOSQUITO HEMOSTATIC CLAMP.....	105	HEMOSTATIC CLAMP BRIDGE.....	116	HIRSCHMAN SPATULA.....	331
HAMMER.....	270, 272	HEMOSTATIC CLAMP COLLER-CRILE.....	106	HIRSCHMANN ANOSCOPE.....	562
HAMMER BERGMANN.....	272	HEMOSTATIC CLAMP CRAFOORD.....	118	HOEN DURA DISSECTOR.....	333
HAMMER COLLIN.....	270	HEMOSTATIC CLAMP CRAFOORD-SELLORS.....	118	HOESEL NEEDLE HOLDER.....	213
HAMMER COTTLE.....	273	HEMOSTATIC CLAMP CRILE.....	107	HOFFER RETRACTOR.....	465
HAMMER GERZOG.....	270	HEMOSTATIC CLAMP CRILE-RANKIN.....	107	HOFFMANN TUBING CLAMP.....	624
HAMMER HAJEK.....	273	HEMOSTATIC CLAMP DANDY.....	109	HOHMANN BONE LEVERS.....	284, 285
HAMMER HEATH.....	273	HEMOSTATIC CLAMP DEBAKEY-MOSQUITO.....	509	HOHMANN MINI.....	286
HAMMER KIRK.....	270	HEMOSTATIC CLAMP DEBAKEY-PEAN.....	513	HOKE CHISELS.....	265
HAMMER LUCAE.....	271	HEMOSTATIC CLAMP DEBAKEY-RANKIN.....	512	HOLDING ARM SYSTEM LEYLA.....	368, 368/1, 368/3, 368/4
HAMMER MEAD.....	271	HEMOSTATIC CLAMP DESJARDINS.....	121	HOLDING CLAMP ADSON.....	298
HAMMER OMBREDANNE.....	273	HEMOSTATIC CLAMP FUCHSIG.....	113	HOLINGER OP-LARYNGOSCOPE.....	37
HAMMER PARTSCH.....	271	HEMOSTATIC CLAMP GEMINI.....	115	HOLLINGER LIGHT GUIDE.....	37
HAMMER QUISLING.....	271	HEMOSTATIC CLAMP GRAY.....	121	HOLSHER NERVE HOOK.....	329
HAMMER WILLIGER.....	271	HEMOSTATIC CLAMP GUYON.....	122	HOLTH RONGEUR.....	380
HAMORRHOID.FORCEPS MCGIVNEY.....	568	HEMOSTATIC CLAMP HALSTED-MOSQUITO.....	105	HOLZBACH HYSTERECTOMYCLAMP.....	126
HAMORRHOID.LIGATORRUDD.....	568	HEMOSTATIC CLAMP HALSTED-MOSQUITO TITANIUM.....	105	HOLZBACH HYSTERECTOMYCLAMP.....	126
HANDLE WITH JACOBS CHUCK.....	300	HEMOSTATIC CLAMP HARTMANN.....	104	HOLZHEIMER RETRACTOR.....	168
HANDLE ALONE.....	591	HEMOSTATIC CLAMP HEISS.....	112	HOOK.....	419, 475
HANDLE FOR CHISELS/CHISELS.....	266	HEMOSTATIC CLAMP JACOBSON.....	105	HOOK BALFOUR.....	193
HANDLE FOR CHISELS/OSTEO.....	266	HEMOSTATIC CLAMP JOHNS-HOPKINS.....	120	HOOK BARBARA.....	419
HANDLE SCALPEL.....	38, 39, 39/1, 39/2, 40, 41	HEMOSTATIC CLAMP KANTROWITZ.....	119	HOOK DAY.....	409
HANDLE SCALPEL MINI.....	41	HEMOSTATIC CLAMP KELLY.....	106	HOOK FISCH.....	335
HANK UTERINE DILATOR.....	580	HEMOSTATIC CLAMP KELLY-RANKIN.....	106	HOOK FORCEPS BARRET.....	582
		HEMOSTATIC CLAMP KOCHER.....	108	HOOK FORCEPS BRAUN.....	582

HOOK FORCEPS CZERNY.....	584	INTERCHANGEABLE TIPS KRAUSE.....	472	JEWELRY TISSUE FORCEPS.....	90
HOOK FORCEPS DUPLAY.....	582	INTERCHANGEABLE TIPS LANGE.....	472	JOBSON-HORNBYE COTTON-APPLICATOR.....	203
HOOK FORCEPS HULKA.....	583	INTERCHANGEABLE TIPS SCHEINMANN.....	472	JOHNS HOPKINS APPLIERFORCEPS.....	104
HOOK FORCEPS IOWA.....	584	INTERCHANGEABLE TIPS SCHUMACHER.....	472	JOHNS-HOPKINS BULLDOG CLAMP.....	104
HOOK FORCEPS JACOBS.....	583	INTERCHANGEABLE TIPS SEIFERT.....	472	JOHNS-HOPKINS HEMOSTATIC.....	120
HOOK FORCEPS JARCHO.....	583	INTERVERTEBRAL DISC RONGEUR COLCLOUGH.....	344/1	JOHNSON NEEDLE HOLDER.....	211
HOOK FORCEPS MUSEUX.....	583	INTRA ORAL RETRACTORS.....	463/1, 463/4	JONES TOWEL CLAMP.....	132
HOOK FORCEPS PRATT.....	584	INTRAMEDULLARY PINS.....	322	JONES-CLIP TOWEL CLAMP.....	132
HOOK FORCEPS SCHROEDER.....	584	INZISIONSSCISSORS.....	52	JORGENSEN DISSECTING SCISSORS.....	53
HOOK FORCEPS SCHROEDER.....	583	IOWA HOOK FORCEPS.....	584	JOSEPH (LEWIS) NOSER.....	443
HOOK FORCEPS SCHROEDER (POZZI).....	582	IOWA NEEDLE GUIDE.....	206	JOSEPH NOSE RASP.....	443
HOOK FORCEPS SKENE.....	582	IRIS HOOK O'CONNOR.....	375	JOSEPH NOSESAW.....	446
HOOK FORCEPS TEALE.....	583	IRIS HOOK WIENER.....	375	JOSEPH RASPARTORIES.....	277
HOOK FORCEPSSTAUDE-MOORE.....	582	IRIS KNIVES DEAN.....	372	JOSEPH SEPTUM.....	437
HOOK GASS.....	376	IRIS KNIVES KNAPP.....	372	JOSEPH SEPTUM KNIVES.....	434
HOOK GELPI.....	193	IRIS KNIVES ZIEGLER.....	372	JOSEPH SEPTUM KNIVES.....	434, 435
HOOK HARRINGTON.....	193	IRIS SCISSORS.....	54	JOSEPH SKIN HOOK.....	149
HOOK KELLY.....	193	IRIS SCISSORS KNAPP.....	55	JOSEPH SURGICAL SCISSORS.....	54
HOOK KUGLEN IRIS.....	376	IRIS SCISSORS LITTLER.....	55	JUDD-ALLIS BOWEL GRASPING FORCEPS.....	538
HOOK LUCAE.....	409	IRIS SPATULA CULLER.....	378	JUDD-MASSON BLADDER RETRACTORS.....	552
HOOK MCGEE.....	419	IRIS SPATULA WECKER.....	378	JUERS MICRO-EAR FORCEPS.....	414
HOOK SCOVILLE.....	196	IRIS SUPERCUT SCISSORS.....	72	JURASZ LARYNGEAL POLYPUS FORCEPS.....	471
HOOK SINSKEY.....	376	IRIS TISSUE FORCEPS BARRAQUER-KATZIN.....	384		
HOOK SMELLIE.....	605	IRIS TISSUE FORCEPS BISHOP-HARMAN.....	386	K	
HOOK WAGENER.....	409	IRIS TISSUE FORCEPS BONN.....	387	KABIERSKE POWDER BLOWER.....	405
HOOKSTEVENS.....	375	IRIS TISSUE FORCEPS FISCHER.....	384	KADER ABDOMINAL SPATULA.....	143/1
HOPKINS PLASTER KNIVES.....	233	IRIS TISSUE FORCEPS FOERSTER.....	383	KALLMORGEN SPECULA.....	573
HORIZON CLIP FORCEPS.....	524	IRIS TISSUE FORCEPS GILL.....	384	KALT CAPSULAR FORCEPS.....	391
HORNBY SKIN SCISSORS CASTROVIEJO.....	79	IRIS TISSUE FORCEPS GILL-HESS.....	384	KALT NEEDLE HOLDER.....	214
HORSLEY DURA DISSECTOR.....	333	IRIS TISSUE FORCEPS GRAEFE.....	382	KALT NEEDLE HOLDER.....	214
HOSEL RETRACTOR.....	167	IRIS TISSUE FORCEPS HESS.....	384	KALT-ARRUGA NEEDLE HOLDER.....	214
HOUSE CURETTE.....	420	IRIS TISSUE FORCEPS KIRBY-ARTHUR.....	385	KANE NAVELSTRINGCLAMP.....	605
HOUSE SUCTION TUBE.....	337/2	IRIS TISSUE FORCEPS MODELL BONN.....	387	KANTROWITZ HEMOSTATCL.....	119
HOWARTH SEPTUM ELEVATOR.....	438	IRIS TISSUE FORCEPS TROUTMAN.....	384, 389	KAYE FACE LIFT SCISSORS.....	73
HUBER UNIVERSALHANDLE.....	472	IRIS TISSUE FORCEPS TYPE TUEBINGEN.....	387	KEINSASSER OP-LARYNGOSCOPE.....	35
HUDSON BONE HAND DRILLS.....	299	IRIS TISSUE FORCEPSSTEVENS.....	383	KEITH NEEDLE.....	223
HUDSON T-HANDLE.....	300	IRRIGATION CANNULA EICKEN (KILLIAN).....	433	KELLY GRIP RETRACTOR.....	142
HULKA HOOK FORCEPS.....	583	IRRIGATION CANNULA HARTMANN.....	433	KELLY HEMOSTATIC CLAMP.....	106
HUMBY DERMATOM.....	50	IRRIGATION CANNULA KILLIAN.....	433/1	KELLY HOOK.....	193
HUNTER SPLINTER FORCEPS.....	91	IRRIGATION CANNULA KILLIAN.....	433/1	KELLY PROCTOSCOPE.....	562, 563
HURD TONSIL ELEVATOR.....	465	IRRIGATION CANNULA RITTER-HALLE.....	433	KELLY RETRACTOR.....	164
HYPOPHYSE CURETTE.....	334	IRRIGATION CANNULA SIEBENMANN.....	433/1	KELLY UTERINE POLYP FORCEPS.....	585
HYPOPHYSEN FORCEPS.....	341	IRRIGATION CANNULA SIMCOE.....	394/2	KELLY VASCULAR SCISSORS.....	61
HYPOPHYSE-TISSUE FORCEPS ADSON.....	334	IRRIGATIONSCANNULA TYPE LACRIMAL.....	394	KELLY-RANKIN HEMOSTATIC CLAMP.....	106
HYSTERECTOMY FORCEPS WERTHEIM-CULLEN.....	125	ISRAEL RETRACTOR.....	162	KERATOPLAST-KNIVES BARRAQUER.....	373
HYSTERECTOMY SCISSORS WERTHEIM.....	63	ITERSON TRACHEA HOOK.....	477	KERATOPLAST-KNIVES PAUFIQUE.....	373
HYSTERECTOMYCLAMP HEANEY.....	126	IVES-FANSLER ANOSCOPE.....	562	KERN BONE HOLDING FORCEPS.....	244
HYSTERECTOMYCLAMP HEANY-BALLENTINE.....	127	IWANSON MEASURING INSTRUMENT.....	624	KERRISON RONGEUR.....	428
HYSTERECTOMYCLAMP ROGERS.....	127			KEVORKIAN BIOPSY CURETTE.....	587
HYSTERECTOMYCLAMP SEGOND.....	125	J		KEVORKIAN BIOPSY FORCEPS.....	589, 591
HYSTERECTOMYCLAMP SEGOND-LANDAU.....	125	JACKSON LARYNGOSCOPE.....	37	KEVORKIAN-PACIFIC BIOPSY FORCEPS.....	592
HYSTERECTOMYCLAMP WERTHEIM.....	124	JACKSON TENDON GRASPING FORCEPS.....	292	KEY ELEVATOR.....	282
HYSTERECTOMYCLAMP WERTHEIM.....	128	JACKSON TRACHEA HOOK.....	476	KEYES PUNCH.....	608
I		JACKSON VAGINAL SPECULA.....	573	KIDNEY CLAMP GUYON.....	122
I.A.D. EXTRAKTION HOOK.....	593	JACKSON-BURROWS RETRACTOR.....	189/2	KIDNEY FORCEPS HERRICK.....	123
I.A.D. GRASPING FORCEPS FLEXIBLE SERPENTINE.....	593	JACOBS HOOK FORCEPS.....	583	KIDNEY STONE FORCEPS HEIMING.....	536
ILLUMINATION ATTACHMENT.....	562	JACOBSON BUTTONPROBES.....	335	KIDNEY STONEFORCEPS RANDALL.....	535
IMPACTOR.....	322	JACOBSON CURETTE.....	257	KIDNEY TRAY.....	619
IMPACTOR/EXTRACTOR.....	322	JACOBSON DURA HOOK.....	335	KIELLAND OBSTETRICAL FORCEPS.....	602
IMPACTOR/EXTRAKTOR.....	322	JACOBSON HEMOSTATIC CLAMP.....	105	KIELLAND-LUIKART OBSTETRICAL FORCEPS.....	603
INEROSSEOUSSCISSORS MCINDOE.....	65/1	JACOBSON NEEDLE HOLDER.....	215	KILLIAN GOUGES.....	442/1
INGE LAMINA SPREADER.....	339	JAEGER DISCISION MESSR.....	372	KILLIAN NOSE SPECULA.....	423
INJECTION CANNULA INJECTION CANNULA.....	36	JAEGER LIDPLATE.....	371	KILLIAN SEPTUM ELEVATO.....	438, 439
INSTRU-CARE INSTRUMENT OIL.....	634	JAMESON STRABISMUS FORCEPS.....	385	KILLIAN SEPTUM SCISSORS.....	471
INSTRUMENT BOX.....	617	JAMESON STRABISMUS HOOK.....	375	KILLIAN-CLAUS SEPTUM GOUGES.....	442/1
INSTRUMENT OIL INSTRU CARE.....	634	JANSEN BONE CURETTES.....	257	KILNER NEEDLE HOLDER.....	212
INSUFFLATIONCANNULA VERESS.....	206	JANSEN BONE RONGEUR.....	237	KILNER NOSE HOOK.....	447/1
INTERCHANGEABLE TIPS BARACANI.....	472	JANSEN EAR FORCEPS.....	424	KILNER SKIN HOOK.....	608
INTERCHANGEABLE TIPS BRUENINGS.....	472	JANSEN RETRACTOR.....	168	KILNER SURGICAL SCISSORS.....	54
INTERCHANGEABLE TIPS CORDES.....	472	JAR.....	620	KILNER/RAGNELL SUPERCUT SCISSORS.....	72
INTERCHANGEABLE TIPS FRAENKEL.....	472	JARCHO HOOK FORCEPS.....	583	KILNER-DOUGHTY.....	456
INTERCHANGEABLE TIPS FRAENKEL.....	472	JAVI CAROTIS SHUNT CLAMP.....	511	KIRBY-ARTHUR IRIS FORCEPS.....	385
		JENNINGS MOUTH GAGS.....	454	KIRK HAMMER.....	270

KIRSCHNER ABDOMINAL RETRACTOR.....	187, 187/1
KIRSCHNER ABDOMINALRETRACTORS.....	185, 187
KIRSCHNER BONE HAND DRILLS.....	299
KIRSCHNER DRILLWIRE.....	306, 307
KIRSCHNER GUIDEPROBES.....	221
KIRSCHNER NAIL.....	308, 309
KIRSCHNER US EXTENSION BOW.....	312
KLAPP RETRACTOR.....	150
KLEINERT-KUTZ HOHLMEIB.....	237
KLEINERT-KUTZ SKIN HOOK.....	149
KLEINERT-KUTZ TENDON GRASPING INSTRUMENT.....	294
KLEINSASSER CHEST SUPPORT.....	36
KLEINSASSER FIBERGLAS-LIGHT GUIDE.....	36
KLEINSASSER INJECTION CANNULA.....	36
KLEINSASSER SUCTION TUBE.....	36
KLEINSCHMIDT APPENDIXBOWEL CLAMP.....	544
KLINKENBERGH-LOTH VASCULAR SCISSORS.....	65/1
KNAPP CATARACT CURETTE.....	378
KNAPP EXTRACTION HOOK.....	375
KNAPP IRIS KNIVES.....	372
KNAPP IRIS SCISSORS.....	55
KNAPP-LUER TRACHOMA FORCEPS.....	393
KNIGHT SEPTUM FORCEPS.....	425
KNIVES AMPUTATION.....	44
KNIVES BALLENGER.....	436
KNIVES BONE.....	44
KNIVES LANGENBECK.....	47
KNIVES MUCK.....	420
KNIVES PLESTER.....	418
KNIVES ROSEN.....	418
KNIVES SCHUKNECHT.....	418
KNIVES TABB.....	418
KNIVESWULLSTEIN.....	418
KNOWLES BANDAGE SCISSORS.....	70
KOCHER BLADDER SPATULA.....	552
KOCHER BOWEL CLAMP.....	540
KOCHER HEMOSTATIC CLAMP.....	108
KOCHER PROBES.....	479
KOCHER RETRACTOR.....	155, 160, 163
KOCHER-LANGENBECK RETRACTOR.....	159
KOENIG NEEDLE.....	223
KOERTE RETRACTOR.....	162
KOGAN ENDOSPECULA.....	577
KÖNIG BONE LEVERS.....	284
KÖNIG GUIDEPROBES.....	221
KÖNIG RASPATORIES.....	276
KÖNIG RETRACTOR.....	153
KOOS DURA KNIVES.....	335
KOPFSCHWARTENFORCEPS GAUSS.....	605
KRAUSE INTERCHANGEABLE TIPS.....	472
KRAUSE POLYP SNARE.....	433/2
KRAUSE POLYP SNARE.....	411, 434
KRAUSE-VOSS POLYP SNARE.....	433/2
KRAYENBUHL NERVE HOOK.....	336
KRISTELLER SPECULA.....	572
KRISTELLER VAGINAL SPECULA.....	572
KROENIG TONGUE DEPRESSORS.....	451
KRONECKER LIGATUREE NEEDLE.....	219
KUGLEN HOOK.....	376
KUHNT CORNEAL SCLEROTOME.....	373
KÜMMEL ABDOMINAL- A. BOWEL SPATULA.....	143/2, 144
KÜNTSCHER DRIVER.....	321
KÜNTSCHER EXTRACTOR.....	322
KÜNTSCHER REAMER.....	321
L	
LA FORCE ADENOID CURETTE.....	450
LA FORCE FOREIGN-BODY NEEDLE.....	374
LA GRANGE GUM SCISSORS.....	69
LABORDE TRACHEA DILATOR.....	476
LACHRYMAL DILAT. WILDER.....	381
LACHRYMAL DILAT.CASTROVIEJO.....	381
LACHRYMAL DILATOR ZIEGLER.....	381

LACHRYMAL PROBES BOWMAN.....	381
LACHRYMAL PROBES HARMS.....	381
LACRIMAL IRRIGATIONS CANNULA.....	394
LAGRANGE SUPERCUT SCISSORS.....	72
LAHEY GRASPING FORCEPS.....	479
LAHEY HEMOSTATIC CLAMP.....	120
LAHEY RETRACTOR.....	149, 157
LAMBERT CHALAZIO TISSUE FORCEPS.....	393
LAMBERT-KAY AORTIC-ANASTOMOSIS CLAMP.....	505
LAMBERT-LOWMAN BONE HOLDING CLAMP.....	249
LAMBOTTE BONE HOLDING FORCEPS.....	244
LAMBOTTE CHISELS.....	261
LAMBOTTE RASPATORIES.....	274, 275
LAMINA SPREADER CLOWARD.....	339
LAMINA SPREADER INGE.....	339
LAMINECTOMY RETRACTOR CHERRY.....	488
LAMINECTOMY RETRACTOR FORCEPS CLOWARD.....	342
LAMINECTOMY RETRACTOR FORCEPS OLDBERG.....	341
LAMINECTOMY RETRACTOR FORCEPS SCHLESINGER.....	342
LAMINECTOMY RETRACTOR FORCEPS SPURLING.....	340
LAMINECTOMY RETRACTOR FORCEPS WAGNER.....	343
LAMINECTOMY RETRACTOR FORCEPSCUSHING.....	340
LAMINECTOMY RETRACTOR FORCEPSFERRIS-SMITH.....	343
LAMINECTOMY RETRACTOR FORCEPSLOVE-GRUENWALD.....	340
LAMINECTOMY RETRACTOR SCOVILLE.....	196
LAMINECTOMY RETRACTOR SCOVILLE-HAVERFIELD.....	196
LANCASTER EYE SPECULA.....	371
LANCETTE ELECTRODE MONOPOLAR.....	628, 629
LANDAU VAGINAL SPECULA.....	577
LANDOLT TUMOR GRASPING FORCEPS.....	341
LANE BENDER.....	325
LANE BONE HOLDING FORCEPS.....	244
LANE BONE LEVERS.....	290
LANE BONE LEVERS.....	290
LANE BONE PLATE HOLDING FORCEPS.....	325
LANE SCREW DRIVER.....	323, 324
LANE SREWHOLDINGFORCEPS.....	325
LANE STOMACH CLAMP.....	547
LANE SURGICAL TISSUE FORCEPS.....	84
LANE TOWEL CLAMP.....	133
LANE TRETOWAN BONE LEVERS.....	290
LANG EXTRACTION DISSECTOR.....	378
LANGE INTERCHANGEABLE TIPS.....	472
LANGE NOSE HOOK.....	448
LANGE-HOHMANN.....	286
LANGENBECK FINGER PROTCTOR.....	311
LANGENBECK AMPUTATION KNIVES.....	44
LANGENBECK BONE HOLDING FORCEPS.....	243
LANGENBECK EAR LOOP.....	409
LANGENBECK FINGER SAW.....	296
LANGENBECK KNIVES.....	47
LANGENBECK NEEDLE HOLDER.....	213
LANGENBECK RASPATORIES.....	275
LANGENBECK RETRACTOR.....	158, 159
LANGENBECK-GREEN RETRACTOR.....	153
LARSEN TENDON GRASPING FORCEPS.....	292
LARYNGEAL CANNULA WIE.....	470
LARYNGEAL MIRROR.....	473
LARYNGEAL MIRROR MICHEL.....	423
LARYNGEAL POLYPUS FORCEPS FRAENKEL.....	471
LARYNGEAL POLYPUS FORCEPS JURASZ.....	471
LARYNGOSCOPE COLD LIGHTHANDLE BATTERY HANDLE.....	33
LARYNGOSCOPE FOREGGER.....	29, 31
LARYNGOSCOPE HOLINGER.....	37
LARYNGOSCOPE JACKSON.....	37
LARYNGOSCOPE MCINTOSH.....	29, 31
LARYNGOSCOPE MILLER.....	30
LARYNGOSCOPE WARM LIGHT BATTERY HANDLE.....	32

LARYNGOSCOPE WARM LIGHT HANDLE WITH TRANSFORMER CONNECTION.....	34
LATERAL VAGINAL RETRACTOR.....	569
LAWRENCE HEMOSTATIC CLAMP.....	119
LEAD HAND.....	250
LEBSCHKE CHISEL.....	267
LEES BRONCHUSCLAMP.....	504
LEGUE BLADDER RETRACTORS.....	553
LEGUEU BLADDER SPATULA.....	552
LEKSELL(STILLE) BONE RONGEUR.....	240
LELAND-JONES VASCULARSCLAMP.....	494
LEMPERT BONE CURETTES.....	256
LEMPERT BONE RONGEUR.....	237
LEMPERT ELEVATOR.....	420
LERCHE GRASPING TISSUE FORCEPS.....	83
LERICHE ABDOMINALSPATULA.....	143/2
LERICHE BOWEL SPATULA.....	143/2
LERICHE HEMOSTATIC CLAMP.....	111
LESTER FIXATION FORCEPS.....	389
LEVINSON FOREIGN-BODY NEEDLE.....	374
LEWIN BONE HOLDING FORCEPS.....	246
LEXER BABY DISSECTING SCISSORS.....	53
LEXER CHISELS.....	263
LEXER DISSECTING SCISSORS.....	53
LEXER MINI GOUGES.....	263
LEYLA HOLDING ARM SYSTEM.....	368, 368/1, 368/3, 368/4
LICHTENBERG NEEDLE HOLDER.....	213
LICHTWITZ CANNULA.....	433
LICHTWITZ TROCAR.....	204
LIEBERMAN EYE SPECULA.....	324
LIGATURE RINGS.....	568
LIGATUREE NEEDLE.....	218
LIGATUREE NEEDLE COOPER.....	219
LIGATUREE NEEDLE DESCHAMPS.....	218
LIGATUREE NEEDLE KRONECKER.....	219
LIGATUREE NEEDLE NELSON.....	219
LIGATUREE NEEDLE SCHMIEDEN-DICK.....	219
LIGHT GUIDE.....	37
LIGHT GUIDE COLD LIGHT JACKSON.....	37
LIGHT GUIDE HOLLINGER.....	37
LIP RETRACTOR.....	453
LISTER BANDAGE SCISSORS.....	69/1
LISTER SUPERCUT SCISSORS.....	72
LISTER(SINUS) DRESSING FORCEPS.....	137
LISTER-BURCH EYE SPECULA.....	370
LISTON AMPUTATION KNIVES.....	44
LISTON BONE CUTTING FORCEPS.....	241
LITTAUER CILIA FORCEPS.....	395
LITTAUER EAR FORCEPS.....	411
LITTAUER POLYP FORCEPS.....	425
LITTAUER SUTURES SCISSORS.....	66
LITTLE RETRACTOR.....	157
LITTLE IRIS SCISSORS.....	55
LITTLEWOOD BOWEL GRASPING FORCEPS.....	538
LOCKHART-MUMMERY FISTULAPROBES.....	200
LOCKLIN GUM SCISSORS.....	69
LOCKWOOD-ALLIS BOWEL GRASPING FORCEPS.....	538
LONDON-COLLEGE TEETH TISSUE FORCEPS.....	93
LOOP ELECTRODE MONOPOLAR.....	628, 629
LOPEZ-REINKE TONSIL.....	465
LORENZ BANDAGE SCISSORS.....	70
LORNA TOWEL CLAMP.....	133
LOUTE WIRE INSTRUMENT.....	315
LOVE NERVE HOOK.....	329, 330
LOVE RETRACTOR.....	465
LOVE-GRUENWALD.....	340
LOVELACE HEMOSTATIC CLAMP.....	109
LOVELACE LUNG GRASPING FORCEPS.....	490
LOWER HEMOSTATIC CLAMP.....	120
LOWMAN BONE HOLDING CLAMP.....	249
LOWMAN-HOGLUND BONE HOLDING CLAMP.....	249
LUBET-BARBON NOSE DRESSING FORCEPS.....	424
LUC SEPTUM FORCEPS.....	426

LUCAE EAR FORCEPS.....	410	MCCEE MICRO-EAR FORCEPS.....	414	MIKULICZ PERITONEUMCLAMP.....	123
LUCAE HAMMER.....	271	MCINDOE INEROSSEOUSSCISSORS.....	65/1	MIKULICZ RETRACTOR.....	163
LUCAE HOOK.....	409	MCINDOE TISSUE FORCEPS.....	85	MIKULICZ-BABY PERITONEUMCLAMP.....	123
LUCAE PARACENTESIS NEEDLE.....	408	MCINTOSH LARYNGOSCOP.....	29, 31	MILLER LARYNGOSCOP.....	30
LUCAE TUNING FORC.....	404	MCINTYRE EYE CANNULA.....	394	MILLER NOSE RASP.....	444
LUER BONE RONGEUR.....	236	MCIVOR MOUTH GAGS.....	457	MILLIGAN DURA DISSECTOR.....	332
LUER RETRACTOR.....	140	MCKENTY SEPTUM ELEVATOR.....	437, 438	MILLIN BLADDER RETRACTORS.....	552
LUER TRACHEA CANNULA.....	479	MCKENZIE APPLIERFORCEPS.....	326	MILLIN BLADDER SPREADER.....	553
LUER-KOERTE GALL STONE CURETTE.....	533	MCLEAN OBSTETRICAL FORCEPS.....	603	MILLIN CAPSULAR GRASPING FORCEPS.....	551
LUIKART OBSTETRICAL FORCEPS.....	603	MCLEAN-LUIKART OBSTETRICAL FORCEPS.....	603	MILLIN PROSTATIC GRASPING FORCEPS.....	551
LUNDSGAARD SKLEROTOM.....	373	MCLEAN-TUCKER-LUIKART OBSTETRICAL FORCEPS.....	603	MINI BULLDOG CLAMP DEBAKEY-DIETHRICH.....	101
LUNG GRASPING FORCEPS LOVELACE.....	490	MCPHERSON TISSUE FORCEPS.....	392	MINI QUICK HANDLE.....	301
LUNG SCISSORS CRAFOORD.....	65/2	MEAD BONE RONGEUR.....	235	MINI SCALPEL.....	41
LUNG SPATULA ALLISON.....	489	MEAD HAMMER.....	271	MINI SCALPEL HANDLE.....	41
LUNIATSCHEK ELEVATOR.....	465	MEASURANCE CIRCLE CASTROVIEJO.....	380	MINI-BULLDOG CLAMP.....	101
LUPUS CURETTE FOX.....	608	MEASURING INSTRUMENT.....	594	MINI-LAMBOTTE CHISELS.....	262
LUPUS CURETTE PIFFARD.....	608	MEASURING INSTRUMENT.....	594	MINIMUS SPHYGMOMANOMETER.....	11, 12
		MEASURING INSTRUMENT IWANSON.....	624	MINI-TOWNSEND-DOWN BIOPSY FORCEPS.....	591
M		MEASURING RULE.....	25	MINI-TOWNSEND-UP BIOPSY FORCEPS.....	591
MAGILL CATETHER INTRODUCING FORCEPS.....	28	MEDICINE CUP.....	621	MIXTER GALL STONE FORCEPS.....	531
MAIER DRESSINGFORCEPS.....	134	MEDICINE SPOON.....	621	MIXTER HEMOSTATIC CLAMP.....	116, 119, 120, 121
MALTZ (COTTLE) NOSE RASP.....	444	MEEKER HEMOSTATIC CLAMP.....	119	MIXTER HEMOSTATIC CLAMP S-CVD.....	116
MALTZ NOSE RASP.....	443	MEHDORN APPLIER FORCEPS.....	362	MIXTER-BABY HEMOSTATIC CLAMP.....	119
MANDIBULAR BODY RETRACTOR HARGIS.....	463/6	MEHDORN VASCULAR CLIP.....	362	MIXTER-O'SHAUGNESSY.....	120
MANDRIN FOR TOURNIQUET.....	528	MELLINGER EYE SPECULA.....	370	MIXTER-O'SHAUGNESSY HEMOSTATIC CLAMP.....	120
MANOMETER.....	295, 596	MELLINGER-AXENFELD EYE SPECULA.....	370	MODELL BONN IRIS TISSUE FORCEPS.....	387
MARKERSCONNIN-AMSLER.....	380	MENGHINI BIOPSY NEEDLE.....	206	MOELTGEN GONIOMETER.....	25
MARQUARD BONE RONGEUR.....	239	MENISCUSHOOK BLOUNT.....	289	MOGEN CIRCUMCISION INSTRUMENT.....	556
MARSHCHIK TONSIL FORCEPS.....	468	MENISCUSKNIVES NEFF.....	292	MOLLISON RETRACTORS.....	171
MARTEL GRASPING FORCEPS.....	110	MENISCUSKNIVES SMILLIE.....	292	MOLT RASPATORIESIUM.....	276
MARTIN BONE HOLDING FORCEPS.....	246	MERCEDES THORACIC SPREADER.....	489	MONOPOLAR ELECTRODE BALL.....	628, 629
MARTIN CARTILAGE SCISSORS.....	65/1	MERIAM TEETH TISSUE FORCEPS.....	93	MONOPOLAR ELECTRODE LANCETTE.....	628, 629
MARTIN PELVIMETER.....	605	METAL CATHETER.....	555	MONOPOLAR ELECTRODE LOOP.....	628, 629
MARTIN RETRACTOR.....	175/1	METAL CATHETER COXETER.....	555	MONOPOLAR ELECTRODE NEEDLE.....	628, 629
MARTIN UTERINE-PROBES.....	586	METZENBAUM "S" SURGICAL SCISSORS.....	54	MOOR GALL STONE CURETTE.....	532
MARTINI BONE CURETTES.....	257	METZENBAUM DISSECTING SCISSORS.....	53/1	MOORE BONE HAND DRILLS.....	298
MASSING-NEIVERT NOSE HOOK.....	447/1	METZENBAUM FINO TC DISSECTING SCISSORS.....	53/1	MOORFIELD TISSUE FORCEPS.....	392
MASSON NEEDLE HOLDER.....	210	METZENBAUM NEEDLE HOLDER.....	211	MORGAN PROCTOSCOPE.....	565
MASTIN MUSCLE CLAMP.....	479	METZENBAUM SUPERCUT SCISSORS.....	71	MORITZ-SCHMIDT TONGUE DEPRESSORS.....	452
MATHIEU FOREIGN-BODY FORCEPS.....	553/1	METZENBAUM TC DISSECTING SCISSORS.....	53/1	MORRIS RETRACTOR.....	164
MATHIEU NEEDLE HOLDER.....	213	MEYERDING RETRACTOR.....	157	MORRIS-DEBAKEY AORTIC CLAMP.....	506
MATHIEU RECTAL-SPECULA.....	560	MEYERDING RETRACTORS.....	180	MORSE RIB SPREADER.....	484
MATHIEU RETRACTOR.....	141	MEYHOEFER CHALAZIO CURETTE.....	377	MORSE-FAVALORO RIB SPREADER.....	484
MATHIEU-OLSEN NEEDLE HOLDER.....	212	MICHEL CLIP.....	224	MOUTH GAGS DAVIS-BOYLE.....	455
MATSON RASPATORIES.....	279	MICHEL CLIP FORCEPS.....	224	MOUTH GAGS DENHART.....	454
MATSON-ALEXANDER RASPATORIES.....	279	MICHEL CLIP TISSUE FORCEPS.....	224	MOUTH GAGS DINGMANN.....	456
MAXI GRASPER BIOPSY FORCEPS.....	593	MICHEL LARYNGEAL MIRROR.....	423	MOUTH GAGS HEISTER.....	454
MAYFIELD BONE RONGEUR.....	238	MICHO FRIEDMANN.....	234	MOUTH GAGS JENNINGS.....	454
MAYO DISSECTING SCISSORS.....	52	MICRO FRIEDMANN BONE RONGEUR.....	234	MOUTH GAGS MCIVOR.....	457
MAYO GALL STONE CURETTE.....	534	MICRO SICKLE KNIVES.....	475	MOUTH GAGS ROSER-KOENIG.....	454
MAYO GALL STONE PROBES.....	534	MICRO-CURETTE FORCEPS WULLSTEIN.....	416	MOUTH GAGSDOYEN-JANSEN(MOLT).....	454
MAYO STERILIZATION CLAMP.....	227	MICRO-EAR FORCEPS.....	413	MOYNIHAN GALL STONE PROBES.....	532
MAYO SUPERCUT SCISSORS.....	71	MICRO-EAR FORCEPS COS.....	414	MOYNIHAN HEMOSTATIC CLAMP.....	121
MAYO TISSUE FORCEPS.....	89	MICRO-EAR FORCEPS DIETER.....	414	MOYNIHAN TOWEL CLAMP.....	133
MAYO TONGUE DEPRESSORS.....	451	MICRO-EAR FORCEPS GREVEN.....	414	MUCK KNIVES.....	420
MAYO-ADAMS RETRACTORS.....	171	MICRO-EAR FORCEPS HAUGH.....	414	MUELLER EYE SPECULA.....	371
MAYO-BLAKE GALL STONE FORCEPS.....	531	MICRO-EAR FORCEPS JUERS.....	414	MÜLLER APPROXIMATOR.....	364
MAYO-COLLINS RETRACTOR.....	141	MICRO-EAR FORCEPS MCGEE.....	414	MÜLLER VASCULAR CLIP.....	365
MAYO-COLLINS RETRACTOR-SET.....	141	MICRO-EAR SCISSORS BELLUCCI.....	413	MURDOCK EYE SPECULA.....	370
MAYO-HABERISSER WIRE FORCEPS.....	319	MICRO-EAR SCISSORS SHEA.....	413	MURPHY RETRACTOR.....	156
MAYO-HEGAR NEEDLE HOLDER.....	209	MICRO-GRASPING FORCEPSREARSCHAFT.....	415	MURPHY-LANE ELEVATOR.....	283
MAYON-GUYON HEMOSTATIC CLAMP.....	122	MICRO-HARTMANN HEMOSTATIC CLAMP.....	104	MUSCLE CLAMP MASTIN.....	479
MAYO-NOBLE DISSECTING SCISSORS.....	52	MICRO-SCISSORS.....	76,77, 78, 80	MUSCLE FORCEPS PRINCE.....	387
MAY-OPHTHALMOSKOP UNI.....	14	MICRO-SCISSORS GOMEL.....	80	MUSCLEHOOK.....	267
MAYO-ROBSON BOWEL CLAMP.....	541	MICRO-SCISSORS HEPP-SCHEIDEL.....	78	MUSCLEHOOK GREEN.....	375
MAYO-STILLE DISSECTING SCISSORS.....	52	MICRO-SCISSORS REDA.....	77, 78, 80	MUSCULE FORCEPS BERKE.....	389
MAYO-STILLE SUPERCUT SCISSORS.....	71	MICRO-SCISSORSBELLUCCI.....	417	MUSEUX HOOK FORCEPS.....	583
MC DONALD ELEVATOR.....	283	MICROSURGICAL TISSUE FORCEPS.....	94	MYLES NOSE FORCEPS.....	427
MC GIVNEY HAEMORRHOIDAL LIGATOR.....	568	MICROSURGICAL TISSUE FORCEPS GOMEL.....	96	MYOMA A SCREW DOYEN.....	594
MC INDOE BONE CUTTING FORCEPS.....	241	MICROVASCULAR NEEDLE HOLDER.....	210	MYOMA KNIVES SECOND.....	594
MC KENZIE DRILL.....	299	MIDDLELDORF RETRACTOR.....	160		
MCCULLOUGH STRABISMUS FORCEPS.....	385	MIDDLETON-JANSEN SEPTUM FORCEPS.....	430		
MCGEE HOOK.....	419	MIKULICZ BOWEL CLAMP.....	543		

N			
NABATOFF VARICOSE VEIN PROBES .....	201	NEEDLE YOUNG-BOOMERANG .....	220
NAEGELE OBSTETRICAL FORCEPS .....	602	NEFF MENISCUS KNIVES .....	292
NAGER RETRACTOR .....	465	NEGUS CHEST SUPPORT .....	459
NAGER TONSIL NEEDLE .....	466	NEIVERT NEEDLE HOLDER .....	208
NAIL BRUSHES .....	611	NEIVERT-ANDERSON CHISEL .....	442
NAIL DRILL .....	297	NELATON PROBES .....	199
NAIL FORCEPS .....	609, 613	NELSON LIGATUREE NEEDLE .....	219
NAIL FORCEPS ANVIL .....	613	NELSON STANDARD TROCER .....	204
NAIL FORCEPS RADOLF .....	297	NELSON TROCER .....	205
NAIL FORCEPS TURNBULL .....	609	NELSON VASCULARTISSUE FORCEPS .....	89
NAIL IMPACTOR .....	322	NEONATAL VASCULAR CLAMP .....	523
NAIL NIPPERS .....	612/2, 613, 614	NEONATAL VASCULAR CLAMP CASTANEDA .....	527
NAIL RASP .....	610	NERVE ENHOOK CUSHING .....	328
NAIL SCISSORS .....	609	NERVE HOOK CRILE .....	328
NAIL SET .....	609	NERVE HOOK DANDY .....	328
NAIL SKIN FORCEPS .....	613	NERVE HOOK GRAHAM .....	328
NAIL SKIN FORCEPS .....	610, 613	NERVE HOOK HOLSHER .....	329
NAIL SPLITTING SCISSORS .....	614	NERVE HOOK KRAYENBUEHL .....	336
NAVELSTRINGCLAMP COLLIN .....	605	NERVE HOOK LOVE .....	329
NAVELSTRINGCLAMP KANE .....	605	NERVE HOOK LOVE .....	330
NEEDLE .....	222, 223	NERVE HOOK SACHS .....	328
NEEDLE BARBARA .....	419	NERVE HOOK SCOVILLE .....	329, 330
NEEDLE ELECTRODE MONOPOLAR .....	628, 629	NERVE HOOK SMITHWICK .....	328
NEEDLE GUIDE IOWA .....	206	NEUGS TONSIL FORCEPS .....	467
NEEDLE HOLDER ADSON .....	211	NEUROSURGICAL SCISSOR STRULLY .....	65
NEEDLE HOLDER ARRUGA .....	214	NEUROSURGICAL SCISSORS .....	65
NEEDLE HOLDER BABY-OLSEN-HEG. ....	212	NEWS TRACHEA HOOK .....	477
NEEDLE HOLDER BABY-WEBSTER .....	208	NIPPERS NAIL .....	612/2, 613, 614
NEEDLE HOLDER BARRAQUER .....	217	NISSEN FINE HEMOSTATIC CLAMP .....	113
NEEDLE HOLDER BARRAQUER MICRO .....	216	NISSEN HEMOSTATIC CLAMP .....	113
NEEDLE HOLDER BAUMGARTNER .....	208	NOISE APPARTUS POLITZER .....	405
NEEDLE HOLDER BOYNTON .....	214	NORFOLK-NORWICH RETRACTORS .....	172
NEEDLE HOLDER BOZEMANN .....	211	NORTHBENT SUTURE SCISSORS .....	66
NEEDLE HOLDER BROWN .....	209	NOSE DRESSING FORCEPS LUBET-BARBON .....	424
NEEDLE HOLDER CASTROVIEJO .....	215	NOSE DRESSING FORCEPS WESTMACOTT .....	424
NEEDLE HOLDER CASTROVIEJO .....	216	NOSE FORCEPS CAPLAN .....	428
NEEDLE HOLDER CASTROVIEJO MICRO .....	215	NOSE FORCEPS HARTMANN .....	427
NEEDLE HOLDER CHEEKSTEEN .....	210	NOSE FORCEPS MYLES .....	427
NEEDLE HOLDER COLLIER125CM .....	208	NOSE FORCEPS SCHMEDEN .....	427
NEEDLE HOLDER CRILE .....	213	NOSE FORCEPS TAKAHASHI .....	427
NEEDLE HOLDER CRILE-MURRAY .....	209	NOSE FORCEPS WATSON-WILLIAMS .....	428
NEEDLE HOLDER CRILE-WOOD TC .....	209	NOSE FORCEPS WEIL-BLAKESLEY .....	426
NEEDLE HOLDER DE BAKEY .....	210	NOSE FORCEPSSTRUYCKEN .....	427
NEEDLE HOLDER DERF .....	208	NOSE HOOK AUFRICHT .....	447
NEEDLE HOLDER FINOCCHIETTO .....	211	NOSE HOOK CONVERSE .....	448
NEEDLE HOLDER GILLIES .....	212	NOSE HOOK COTTLE .....	447, 447/1
NEEDLE HOLDER HALSEY .....	208	NOSE HOOK HOOK .....	447
NEEDLE HOLDER HALSEY .....	208	NOSE HOOK LANGE .....	448
NEEDLE HOLDER HEANEY .....	210	NOSE HOOK MASING-NEIVERT .....	447
NEEDLE HOLDER HOESSEL .....	213	NOSE RASP FOMON .....	444, 445
NEEDLE HOLDER JACOBSON .....	215	NOSE RASP JOSEPH .....	443
NEEDLE HOLDER JOHNSON .....	211	NOSE RASP JOSEPH (LEWIS) .....	443
NEEDLE HOLDER KALT-ARRUGA .....	214	NOSE RASP MALTZ .....	443
NEEDLE HOLDER KILNER .....	212	NOSE RASP MALTZ (COTTLE) .....	444
NEEDLE HOLDER LANGENBECK .....	213	NOSE RASP MILLER .....	444
NEEDLE HOLDER LICHTENBERG .....	213	NOSE RASP PEET .....	446
NEEDLE HOLDER MASSON .....	210	NOSE RASP WIENER .....	443
NEEDLE HOLDER MATHIEU .....	213	NOSE SCISSORS .....	429
NEEDLE HOLDER MATHIEU-OLSEN .....	212	NOSE SCISSORS COTTLE .....	59
NEEDLE HOLDER MAYO-HEGAR .....	209	NOSE SCISSORS FOMON .....	58
NEEDLE HOLDER METZENBAUM .....	211	NOSE SCISSORS HEYMANN .....	58
NEEDLE HOLDER MICROVASCULAR .....	210	NOSE SCISSORS KILLIAN .....	423
NEEDLE HOLDER NEIVERT .....	208	NOSE SPECULA COTTLE .....	58
NEEDLE HOLDER OLSEN-HEGAR .....	212	NOSE SPECULA HARTMANN .....	422
NEEDLE HOLDER RYDER .....	210	NOSE SPECULA HARTMANN-HALLE .....	421
NEEDLE HOLDER SAROT .....	211	NOSE SPECULA KILLIAN .....	423
NEEDLE HOLDER ST.EVENS .....	214	NOSE SPECULA REDA .....	423
NEEDLE HOLDER STRATTE .....	212	NOSE SPECULA THUDICHUM .....	421
NEEDLE HOLDER WEBSTER .....	208	NOSE SPECULA TIECK-HALLE .....	423
NEEDLE REVERDIN .....	220	NOSE SPECULA TYPE VIENNA .....	421
NEEDLE ROSEN .....	419	NOSE SPECULA VOLTOLINI .....	421
NEEDLE STERILIZATION CASE .....	615	NOSEOLIVE POLITZER .....	406
		NOSESAW JOSEPH .....	446
		NOTO UTERINE POLYP FORCEPS .....	585
		NOVA SPHYGMOMANOMETER .....	6, 7
		NOVAK BIOPSY CURETTE .....	587
		NOYES EYESCISSORS .....	75
		NOYES POLYP FORCEPS .....	425
		NUCLEUS ROTATOR BECHERT .....	379
		NYSTAGMUS SPECTACLES FRENZEL .....	20
		O	
		OBDUKTIONS-BESTECK .....	269
		OBSTETRICAL CURETTE SELLHEIM .....	607
		OBSTETRICAL FORCEPS BARTON .....	603
		OBSTETRICAL FORCEPS BOERMA .....	604
		OBSTETRICAL FORCEPS DE LEE .....	602
		OBSTETRICAL FORCEPS ELLIOT .....	602
		OBSTETRICAL FORCEPS KIELLAND .....	602
		OBSTETRICAL FORCEPS KIELLAND-LUIKART .....	603
		OBSTETRICAL FORCEPS LUIKART .....	603
		OBSTETRICAL FORCEPS MCLEAN .....	603
		OBSTETRICAL FORCEPS MCLEAN-LUIKART .....	603
		OBSTETRICAL FORCEPS MCLEAN-TUCKER .....	603
		OBSTETRICAL FORCEPS MCLEAN-TUCKER-LUIKART .....	603
		OBSTETRICAL FORCEPS MCGEE .....	602
		OBSTETRICAL FORCEPS PIPER .....	604
		OBSTETRICAL FORCEPS SIMPSON .....	602
		OBSTETRICAL FORCEPS SIMPSON-BRAUN .....	602
		OBSTETRICAL FORCEPS SIMPSON-LUIKART .....	603
		OBSTETRICAL FORCEPS WRIGLEY .....	602
		OBWEGESER AHLE .....	463
		OBWEGESER BLADE OSTEOTOME .....	464/1
		OBWEGESER RASPIRIES .....	462
		OBWEGESER RETRACTOR .....	460, 461
		OBWEGESER RETRACTORS .....	463
		OCHSNER TROCER .....	205
		O'CONNOR IRIS HOOK .....	375
		OEHLER SURGICAL TISSUE FORCEPS .....	81/1
		OLDBERG LAMINECTOMY RETRACTOR FORCEPS .....	341
		OLIVECRONA BONE RONGEUR .....	237
		OLIVECRONA BRAINSPATULA .....	336
		OLIVECRONA DURA DISSECTOR .....	332
		OLIVECRONA WIRESAW .....	332
		OLIVECRONA-TOENNIS (SCOVILLE) .....	326
		OLIVECRONA-TOENNIS APPLIERFORCEPS .....	326
		OLLIER RETRACTOR .....	162
		OLSEN-HEGAR NEEDLE HOLDER .....	212
		OMBREDANNE HAMMER .....	273
		OPHTHALMOSKOP MAY UNI II .....	14
		OP-LARYNGOSCOPE HOLLINGER .....	37
		OP-LARYNGOSCOPE JACKSON .....	37
		OP-LARYNGOSCOPE KLEINSASSER .....	35
		OPHTHALMOLOGIC SCISSORS .....	57, 58
		OPHTHALMOLOGIC SCISSORS AEBLI .....	58
		OPHTHALMOLOGIC SCISSORS GRADLE .....	57
		OPHTHALMOLOGIC SCISSORSSTEVENS .....	58
		OSCILLATING PLASTER CAST SAW .....	230
		OSTEOTOME BLADE OBWEGESER .....	464/1
		OSTEOTOME EPKER .....	464/2
		OSTROEM ANTRUM-PUNCH .....	430
		O'SULLIVAN-O'CONNOR ABDOMINALDECKEN .....	181
		O'SULLIVAN-O'CONNOR ABDOMINALRETRACTORS .....	181
		O'SULLIVAN-O'CONNOR SP .....	576
		OTIS URETHROTOME .....	553
		OTOSKOPE DIAGNOSTIC SET UNI I .....	13
		OVAL RING .....	194
		OVERHOLT HEMOSTATIC CLAMP .....	114
		OVERHOLT-BABY HEMOSTATIC CLAMP .....	114
		OVERHOLT-GEISENDOERFER HEMOSTATIC CLAMP .....	114
		OVERHOLT-MIXTER HEMOSTATIC CLAMP .....	115
		OVUM CURETTE CUZZI .....	606
		OVUM CURETTE PESTALOZZA .....	606
		OVUM CURETTE WALLICH .....	607
		OVUM FORCEPS SAENGER .....	606
		OVUM FORCEPS WINTER .....	606



P	
PAN BED	621
PAN PLACENTA	621
PARACENTESIS NEEDLE LUCAE	408
PARACENTESIS NEEDLE POLITZER	408
PARAMETRIUM SCISSORS	63
PARK EYE SPECULA	371
PARKER RETRACTOR	139
PARTSCH CHISELS	259
PARTSCH HAMMER	271
PASSOW CHISELS	260
PATELLA FORCEPS	248
PATON CORNEAL DISSECTOR	373
PAUFIQUE KERATOPLAST-KNIVES	373
PAUFIQUE TISSUE FORCEPS	392
PAYR BOWEL CLAMP	548
PAYR GUIDE PROBES	221
PEAN HEMOSTATIC CLAMP	108
PEAN HEMOSTATIC CLAMP	110
PEAN HEMOSTATIC CLAMP	108, 110
PECK-JOSEPH DISSECTINGSCISSORS	74
PEERSON VAGINAL SPECULA	570
PEENFIELD DISSECTOR	333
PEERS TOWEL CLAMP	132
PEET NOSE RASP	446
PEET SPLINTER FORCEPS	92
PELVIMETER COLLIER	605
PELVIMETER MARTIN	605
PELVIS-HOOK ST.MARKS	165
PENISCLAMP STOCKMANN	553/1
PENISCLAMP STRAUSS	553/1
PENNINGTON HEMOSTATIC CLAMP	109
PENNINGTON SEPTUM ELEVATOR	438
PERCUSSION HAMMER BABINSKY	24
PERCUSSION HAMMER BERLINER	24
PERCUSSION HAMMER BUCK	24
PERCUSSION HAMMER TAYLOR	24
PERCUSSION HAMMER TROEMNER	24
PERCY RETRAKTOR	296
PERFORATORS SMELLIE	607
PERIPHERAL-VASCULAR CLAMP DE BAKEY	494
PERIPHERAL-VASCULAR CLAMP LELAND-JONES	494
PERITONEUMCLAMP FAURE	123
PERITONEUMCLAMP MIKULICZ	123
PERITONEUMCLAMP MIKULICZ-BABY	123
PERITONEUMCLAMP PHANEUF	123
PERKINS RETRACTORS	168
PERTHES AWL	304
PESTALOZZA OVUM CURETTE	606
PETRI BOX	620
PETZ STOMACH AND BOWEL SUTUREING APPARATUS	549
PHALANGEN KNIVES	44
PHANEUF PERITONEUM CLAMP	123
PIERCE SEPTUM	438
PIERCE TROCAR	204
PIFFARD LUPUS CURETTE	608
PILLING CLIP FORCEPS	524
PIN CUTTER	320
PINARD STETHOSCOPE	23
PINWHEEL WARTENBERG	25
PIPER OBSTETRICAL FORCEPS	604
PISTOL FOR CLEANING	626
PLACENTA PAN	621
PLASTER CAST SAW ELEKTRISCH	230
PLASTER CAST SAW ENGEL	229
PLASTER FORCEPS WOLFF	233
PLASTER KNIVES ESMARCH	233
PLASTER KNIVES HOPKINS	233
PLASTER KNIVES REINER	233
PLASTER KNIVES WIGMORE	229
PLASTER RETRACTOR BEESON	232
PLASTER RETRACTOR HAGLUND-STILLE	232

PLASTER RETRACTOR HENNING	232
PLASTER RETRACTOR REDA	232
PLASTER VACUUM WITH OSCILLATING PLASTER SAW	231
PLASTERSCISSORSSTILLE	229
PLASTIK-HAMMER	271
PLATTE JAEGER	371
PLEKMANN DRESSING FORCEPS	137
PLESTER KNIVES	418
PLESTER RETRACTORS	171
PLESTER SUCTION TUBE	338
PNEUMATIC TOURNIQUE	295
POLITZER AIR BLOWER	406
POLITZER EAR KNIVES	408
POLITZER EAR SPECULA	399
POLITZER NOSEOLIVE	406
POLITZER PARACENTESIS NEEDLE	408
POLYP FORCEPS HARTMANN	424
POLYP FORCEPS LITTAUER	425
POLYP FORCEPS NOYES	425
POLYP LOOP	411
POLYP SNARE KRAUSE	433/2
POLYP SNARE KRAUSE	411, 434
POLYP SNARE KRAUSE-VOSS	433/2
POLYP SNARE WILDE	433/2
POLYP SNARE WILDE	411, 434
POOLE SUCTION TUBE	27
POST MORTEM	268
POST MORTEM KNIVES	48
POST MORTEM KNIVES VIRCHOW	48
POTTS SMITH SURGICAL TISSUE FORCEPS	81
POTTS-DE MARTEL VASCULARSCISSORS	59
POTTS-SMITH ANATOMIC TISSUE FORCEPS	81
POTTS-SMITH VASCULAR SCISSORS	61
PRATT FISTULA PROBES	563
PRATT GRASPING FORCEPS	110
PRATT HOOK FORCEPS	584
PRATT RECTAL-SPECULA	559
PRATT UTERINE DILATATOR	580
PRECISA SPHYGMOMANOMETER	9
PRICE-THOMAS BRONCHUS CLAMP	490
PRINCE MUSCLE FORCEPS	387
PRINCE TONSIL SCISSORS	59
PROBE AND PACKER	612
PROBE TIPS	201
PROBES BRODIE	199
PROBES DOYEN	199
PROBES FISH	199
PROBES HARMS	333
PROBES KOCHER	479
PROBES NELATON	199
PROBES VALLEIX	586
PROBES WATSON-CHEYNE	199
PROBES WORST	333
PROCTOSCOPE BENSAUDE	565
PROCTOSCOPE CHELSEA-EATON	563
PROCTOSCOPE FANSLER	564
PROCTOSCOPE KELLY	562, 563
PROCTOSCOPE MORGAN	565
PROSTATIC GRASPING FORCEPS MILLIN	551
PROSTATIC HOOK YOUNG	550
PROVIDENCE-HOSPITAL HEMOSTATIC CLAMP	106
PUNCH KEYS	608
PUNCTION CANNULA FRAZIER	337
PUNCTION CANNULA LICHTWITZ	433
PUNCTION CANNULA QUINKE	206
PUTTI BONE RASP	294
PYLORUSRETRACTOR BENSON	544

Q	
QUERVAIN ELEVATOR	275
QUICK HANDLE	301
QUINBY GUM SCISSORS	67
QUINKE PUNCTION CANNULA	206
QUIRE FOREIGN-BODY LEVER	412
QUISLING HAMMER	271
R	
RACHIOTOM	267
RADOLF NAIL FORCEPS	297
RALK BONE HAND DRILLS	300
RAMPLEY DRESSING FORCEPS	136
RAMUS RETRACTOR	461
RANDALL BIOPSY CURETTE	587
RANDALL KIDNEY STONE FORCEPS	535
RANEY APPLING FORCEPS	327
RANGELL RETRACTOR	140
RASPATORIES	279
RASPATORIES ADSON	282
RASPATORIES ALEXANDER	276
RASPATORIES COBB	280
RASPATORIES DINGMANN	463, 463/3
RASPATORIES DOYEN	278
RASPATORIES FARABEUF	274
RASPATORIES FARABEUF-COLLIN	274
RASPATORIES FOMON	277
RASPATORIES JOSEPH	277
RASPATORIES KOENIG	276
RASPATORIES LAMBOTTE	274
RASPATORIES LANGENBECK	275
RASPATORIES MATSON	279
RASPATORIES MATSON-ALEXANDER	279
RASPATORIES OBWEGESER	462
RASPATORIES SEMB	278
RASPATORIES WILLIGER	276
RASPATORIESIUM MOLT	276
RASPATORIESIUM WIBERG	277
RASPATORIESSEDDILLT	274, 275
RASPATORY HARGIS	463/2
RASPATORY SELDING	277
RAZOR BLADES	45
REAMER KUENTSCHER	321
RECAMIER UTERINE CURETTE	597
RECTAL BIOPSY FORCEPS TURREL	567
RECTAL SUCTION TUBE BUIE	566
RECTALBIOPSY FORCEPS YEOMAN	566, 567
RECTALSNARE WESTON	566
RECTAL-SPECULA ALAN-PARKS	561
RECTAL-SPECULA BARR	559
RECTAL-SPECULA BODENHAMMER	559
RECTAL-SPECULA CZERNY	559
RECTAL-SPECULA HILL-FERGUSON	560
RECTAL-SPECULA MATHIEU	560
RECTAL-SPECULA PRATT	559
RECTAL-SPECULA SAWYER	560
RECTAL-SPECULA SCHULZE-BERG	560
RECTAL-SPECULA SIMS	559
RECTUM-ANAST.KL. HAYES	545
REDA TUNING FORC	403
REDA AMPUTATION KNIVES	44
REDA BLADEBREAKER	45
REDA BONE CURETTES	256
REDA BONE HAND DRILLS	300
REDA BONE HOLDING FORCEPS	246, 247
REDA BOWEL GRASPING FORCEPS ATRAUMA	111
REDA CILIA FORCEPS	395
REDA COTTON-APPLICATOR	203
REDA EXCENTER BANDAGE SCISSORS	69/2
REDA EYE MAGNET	395
REDA FINGER RING SAW	297
REDA NOSE SPECULA	423
REDA PLASTER RETRACTOR	232

REDA SICKLE KNIVES.....	435	RETRACTOR MORRIS.....	164	RIB SPREADER HAIGHT.....	487
REDA SKIN HOOK.....	150	RETRACTOR MURPHY.....	156	RIB SPREADER MORSE.....	484
REDA STERILIZATIONFORCEPS.....	615	RETRACTOR NAGER.....	465	RIB SPREADER MORSE-FAVALORO.....	484
REDA SUTUREFORC.....	221	RETRACTOR OBWEGESER.....	460, 461	RIB SPREADER RIENHOFF-FINOCCHIETTO.....	486
REDON GUIDE NEEDLE.....	207	RETRACTOR OLLIER.....	162	RIB SPREADER TUFFIER.....	487
REES FACE LIFT SCISSORS.....	73	RETRACTOR PARKER.....	139	RIB SPREADERBAILEY-GIBBON.....	489
REICHERT DECKEL EPIGLOTTIS RETRACTOR.....	471	RETRACTOR RAGNELL.....	140	RIBBON BOWEL SPATULA.....	143
REILL BONE HOLDING FORCEPS.....	248	RETRACTOR RAMUS.....	461	RICARD ABDOMINALRETRACTORS.....	191
REINER EAR SYRINGE.....	406	RETRACTOR RICHARDSON.....	142	RICHARDSON RETRACTOR.....	142
REINER PLASTER KNIVES.....	233	RETRACTOR RICHARDSON GRIP.....	142	RICHARDSON-EASTMAN RETRACTOR.....	142
REKORDSYRINGE.....	596	RETRACTOR RICHARDSON-EASTMAN.....	142	RICHARDSON-GRIP RETRACTOR.....	142
RESANO BOWEL CLAMP.....	542	RETRACTOR ROSE.....	140	RICHNAU-HOLMGREN EAR SPECULA.....	400
RESANO CAPSULA SCISSORS.....	53/2	RETRACTOR ROUX.....	139	RICHTER-HEATH CLIP FORCEPS.....	224
RESECTION KNIVES.....	47	RETRACTOR ROUX-BABY.....	140	RIENHOFF-FINOCCHIETTO RIB SPREADER.....	486
RETRACTOR ALM.....	168	RETRACTOR ROUX-MINI.....	140	RIGBY ABDOMINALRETRACTORS.....	189/2
RETRACTOR ANDERSON.....	198	RETRACTOR SAUERBRUCH.....	164	RI-MINI DIAGNOSTIC SET.....	17
RETRACTOR ASSEMBLY.....	188	RETRACTOR SAUERBRUCH.....	164, 166	RING OVAL.....	194
RETRACTOR AUFRANC.....	289	RETRACTOR SENN-GREEN.....	153	RING ROUND.....	194
RETRACTOR BREAST.....	198	RETRACTOR SENN-MILLER.....	143	RING SEGMENT.....	194
RETRACTOR BRUNNER.....	167	RETRACTOR SIMON.....	164	RING TONGUE DEPRESSORS.....	455
RETRACTOR COLLIN.....	139	RETRACTOR SPINA-NASALIS.....	461	RINGS LIGATURE.....	568
RETRACTOR COLLIN HARTMANN.....	141	RETRACTOR TEBBETTS.....	197	RITTER-HALLE IRRIGATION CANNULA.....	433
RETRACTOR COOLEY.....	148	RETRACTOR TESSIER.....	463/3	ROBB SPATULA.....	530
RETRACTOR CORONAL BROW.....	198	RETRACTOR TUFFIER.....	147	ROBERTS HEMOSTATIC CLAMP.....	117
RETRACTOR CORYLLOS.....	166	RETRACTOR US-ARMY PARKER-LANG.....	141	ROCHARD ABDOMINAL RETRACTORS.....	186
RETRACTOR CRILE.....	140	RETRACTOR VOLKMANN.....	153	ROCHESTER-CARMALT HEMOSTATIC CLAMP.....	109
RETRACTOR CUSHING.....	151	RETRACTOR VOLKMANN.....	156	ROCHESTER-OCHSNER HEMOSTATIC CLAMP.....	108
RETRACTOR DAVIDSON (SCAPULA).....	166	RETRACTOR YANCOSKIE.....	198	ROCHESTER-PEAN HEMOSTATIC CLAMP.....	108
RETRACTOR DEAVER.....	145	RETRACTOR ZENKER.....	161	ROEDER TOWEL CLAMP.....	132
RETRACTOR DEAVER GRIP.....	146	RETRACTORS ADSON.....	173	ROGER SEPTUM.....	437
RETRACTOR DEBAKEY.....	189/1	RETRACTORS ADSON.....	172, 173, 174	ROGERS HYSTERECTOMYCLAMP.....	127
RETRACTOR DELEE.....	574	RETRACTORS ANDERSON-ADSON.....	172	ROGGE STERILIZATION FORCEPS.....	227
RETRACTOR DESMARRES.....	151	RETRACTORS BECKMANN.....	176	ROLLET EXTIRPATION CHISELS.....	374
RETRACTOR DESMARRES.....	151	RETRACTORS BECKMANN-ADSON.....	175	ROLLET EXTRACTION HOOK.....	375
RETRACTOR DOYEN.....	163	RETRACTORS BECKMANN-EATON.....	176	RONGEUR CITELLI.....	430
RETRACTOR DOYEN-STILLE.....	167	RETRACTORS CASPAR.....	179, 180	RONGEUR FERRIS-SMITH-KERRISON.....	344, 344/2
RETRACTOR FARABEUF.....	139	RETRACTORS CLOWARD.....	178	RONGEUR HAJEK-KOFLER.....	429, 431
RETRACTOR FERRIERA.....	197	RETRACTORS DARLING.....	178	RONGEUR HOLTH.....	380
RETRACTOR FINSEN.....	168	RETRACTORS HENLEY.....	170	RONGEUR KERRISON.....	428
RETRACTOR FREEMAN.....	198	RETRACTORS MAYO-ADAMS.....	171	ROSE RETRACTOR.....	140
RETRACTOR FRITSCH.....	163	RETRACTORS MEYERDING.....	180	ROSEN KNIVES.....	418
RETRACTOR GIL-VERNET.....	152	RETRACTORS MOLLISON.....	171	ROSEN NEEDLE.....	419
RETRACTOR GOELET.....	141	RETRACTORS NORDFOLK-NORDWICH.....	172	ROSEN SUCTION TUBE.....	338
RETRACTOR GREEN.....	160	RETRACTORS PERKINS.....	168	ROSER-KOENIG.....	454
RETRACTOR HARRINGTON.....	147	RETRACTORS PLESTER.....	171	ROUND RING MEDIUM.....	194
RETRACTOR HARRINGTON-PEMBERTON.....	147	RETRACTORS PLESTER.....	171	ROUX MINI RETRACTOR.....	140
RETRACTOR HEANEY.....	164	RETRACTORS PLESTER.....	171	ROUX RETRACTOR.....	139
RETRACTOR HIBBS.....	164	RETRACTORS SCALP-CONTOUR.....	169	ROUX-BABY RETRACTOR.....	140
RETRACTOR HOESEL.....	167	RETRACTORS TRAVERS.....	172	ROWE.....	459
RETRACTOR HOFER.....	465	RETRACTORS WEITLANER.....	169	RUBIN SEPTUM FORCEPS.....	428
RETRACTOR HOLZHEIMER.....	168	RETRACTORS WULLSTEIN.....	171	RUDD HAEMORRHOIDAL LIGATOR.....	568
RETRACTOR ISRAEL.....	162	RETRACTOR PERCY.....	296	RUMEL HEMOSTATIC CLAMP.....	117
RETRACTOR JACKSON-BURROWS RETRACTOR.....	189/2	REVERDIN BOWEL SPATULA.....	143/1	RUMEL-BELMONT TOURNIQUET.....	528
RETRACTOR JANSEN.....	168	REVERDIN NEEDLE.....	220	RUSKIN BONE RONGEUR.....	239
RETRACTOR KELLY.....	164	REYNOLDS SUPERCLUT SCISSORS.....	72	RUSKIN-LISTON BONE CUTTING FORCEPS.....	241
RETRACTOR KELLY GRIP.....	142	REYNOLDS SURGICAL SCISSORS.....	54	RUSS MODELL GRASPING TISSUE FORCEPS.....	85
RETRACTOR KLAPP.....	150	RHINOPLASTIKSCISSORS FOMON.....	65/1	RUSSEL-DAVIS.....	458
RETRACTOR KOCHER.....	155	RIB SCISSORS.....	480	RYDEL-SEIFFERT TUNING FORC.....	404
RETRACTOR KOCHER.....	160, 163	RIB SCISSORS BETHUNE.....	481	RYDER NEEDLE HOLDER.....	210
RETRACTOR KOCHER-LANGENBECK.....	159	RIB SCISSORS BRUNNER.....	481		
RETRACTOR KOERTE.....	162	RIB SCISSORS CORYLLOS.....	480		
RETRACTOR KONIG.....	153	RIB SCISSORS GIERTZ-STILLE.....	481		
RETRACTOR LAHEY.....	157	RIB SCISSORS GLUCK.....	480		
RETRACTOR LANGENBECK.....	158, 159	RIB SCISSORS SAUERBRUCH.....	481		
RETRACTOR LANGENBECK-GREEN.....	153	RIB SCISSORS SAUERBRUCH-FREY.....	481		
RETRACTOR LITTLE.....	157	RIB SCISSORSSTILLE.....	480		
RETRACTOR LOVE.....	465	RIB SPREADER BAILEY.....	489		
RETRACTOR MARTIN.....	175/1	RIB SPREADER BAILEY-BABY.....	489		
RETRACTOR MATHIEU.....	141	RIB SPREADER COOLEY.....	487		
RETRACTOR MEYERDING.....	157, 177	RIB SPREADER COOLEY-NEONATAL.....	485		
RETRACTOR MEYERDING.....	177	RIB SPREADER DE BOER.....	486		
RETRACTOR MIDDELDORFF.....	160	RIB SPREADER FINOCCHIETTO.....	482, 484		
RETRACTOR MIKULICZ.....	163	RIB SPREADER FINOCCHIETTO-BURFORD.....	483		

S	
SAALFELD COMEDONE EXTRACTOR.....	608
SACHS DURA DISSECTOR.....	332
SACHS NERVE HOOK.....	328
SAENGER OVUM FORCEPS.....	606
SAGITTAL SPLIT RETRACTOR SMITH.....	463/5
SALPINGOGRAPHSCHULTZE.....	596
SANVENERO SURGICAL SCISSORS.....	54
SAROT HEMOSTATIC CLAMP.....	118
SAROT NEEDLE HOLDER.....	211
SATINSKY TANGENTIALCLAMP.....	502
SATINSKY VASCULARSCISSORS.....	65/1
SATINSKY VASCULARSCLAMP.....	491

SATO CORNEAL SCARIFIER.....	373	SCOVILLE NERVE HOOK.....	329, 330	SIEBENMANN IRRIGATION CANNULA.....	433/1
SATTERLEE AMPUTATION SAW.....	296	SCOVILLE-HAVERFIELD LAMINECTOMY		SIEBOLD GYNECOLOGICAL SCISSORS.....	62
SAUERBRUCH BONE RONGEUR.....	240	RETRACTORRETRACTOR.....	196	SIEGLE EAR SPECULA.....	402
SAUERBRUCH RETRACTOR.....	164	SCREW DRIVER.....	232	SILICONMATT.....	616
SAUERBRUCH RETRACTOR.....	164, 166	SCREW DRIVER LANE.....	323	SILVER DERMATOM.....	50
SAUERBRUCH RIB SCISSORS.....	481	SCREW DRIVER WILLIAMS.....	323	SILVER SEPTUM CHISELS.....	442
SAUERBRUCH WASTEFORCEPS.....	227	SCREW HOLDING SLEEVE.....	324	SILVERCLAMP.....	326
SAUERBRUCH-FREY STERNUM SCISSORS.....	481	SCUDDER BOWEL CLAMP.....	541	SIMCOE IRRIGATION CANNULA.....	394/2
SAW BLADES FOR AUTOPSY SAW.....	231/2	SEBLEAU ELEVATOR.....	275	SIMON RETRACTOR.....	164
SAW GIGLI.....	332	SECTION NEEDLE.....	268	SIMON UTERINE CURETTE.....	594
SAWTELL TONSIL FORCEPS.....	467	SEDILOT RASPARTORIES.....	274	SIMPLEX TUBING CLAMP.....	624
SAWYER RECTAL SPECULA.....	560	SEGMENTED RING.....	194	SIMPSON OBSTETRICAL FORCEPS.....	602
SAYRE ELEVATOR.....	281	SEGOND HYSTERECTOMYCLAMP.....	125	SIMPSON-BRAUN OBSTETRICAL FORCEPS.....	602
SCAGLIETTI BONE RONGEUR.....	240	SEGOND MYOMA KNIVES.....	594	SIMPSON-LUIKART OBSTETRICAL FORCEPS.....	603
SCALP-CONTOUR RETRACTORS.....	169	SEGOND-LANDAU HYSTERECTOMYCLAMP.....	125	SIMS GYNECOLOGICAL SCISSORS.....	62
SCALPEL.....	46	SEIFERT INTERCHANGEABLE TIPS.....	472	SIMS RECTAL-SPECULA.....	559
SCALPEL MINI.....	41	SELDIN RASPARTORY.....	277	SIMS UTERINE CURETTE.....	597
SCALPEL STERILE.....	43	SELLHEIM OBSTETRICAL CURETTE.....	607	SIMS UTERINE DILATOR.....	581
SCALPEL-BLADE.....	42	SEMB BONE CUTTING FORCEPS.....	242	SIMS UTERINE-DEPRESSOR.....	586
SCALPELBLADE REMOVER.....	42	SEMB BONE HOLDING FORCEPS.....	243	SIMS UTERINE-PROBES.....	586
SCALPEL-HANDLE.....	38, 39, 39/1, 39/2, 40, 42	SEMB BONE RONGEUR.....	240	SIMS VAGINAL SPECULA.....	573
SCALPEL-HANDLE COLLIN.....	40	SEMB BRONCHUSCLAMP.....	491	SIMS-MAIER DRESSINGFORCEPS.....	134
SCALPELHANDLE MINI.....	41	SEMB RASPARTORIES.....	278	SINGLEY TISSUE FORCEPS.....	88
SCHAEDEL TOWEL CLAMP.....	132	SEMKEN ANATOMIC TISSUE FORCEPS.....	86	SINSKEY HOOK.....	376
SCHAMBERG COMEDONE EXTRACTOR.....	608	SEMKEN SURGICAL TISSUE FORCEPS.....	86	SINUS SEPTUM ELEVATOR.....	438
SCHEDI BONE CURETTES.....	251	SEMM VAGINAL SPECULA.....	571	SINUSCOPY FORCEPS.....	431
SCHIEE GONIOTOMY KNIVES.....	373	SENN-GREEN RETRACTOR.....	153	SINUSCOPY-TROCAR.....	205
SCHNEIMANN INTERCHANGEABLE TIPS.....	472	SENN-MILLER RETRACTOR.....	143	SINUS-PROBES.....	438
SCHERBAK VAGINAL SPECULA.....	575	SEPTUM CANNULA.....	406	SISIMPACTION FORCEPS ROWE.....	459
SCHINK DERMATOME.....	49	SEPTUM CHISELS CINELLI.....	441	SKENE HOOK FORCEPS.....	582
SCHIOETZ TONOMETER.....	394/2	SEPTUM CHISELS COTTLE.....	440	SKIN HOOK COTTLE.....	447, 448
SCHLESINGER LAMINECTOMY RETRACTOR FORCEPS		SEPTUM CHISELS FOMON.....	441	SKIN HOOK COTTLE-NEIVERT.....	448
.....	342	SEPTUM CHISELS FREER.....	439	SKIN HOOK FOMON.....	447/1
SCHMEDEN NOSE FORCEPS.....	427	SEPTUM CHISELS SHEEHAN.....	441	SKIN HOOK FRAZIER.....	149
SCHMID VASCULAR-IRRIGATION CANNULA.....	338	SEPTUM CHISELS SILVER.....	442	SKIN HOOK FREER.....	448
SCHMIDEN GUIDEPROBES.....	221	SEPTUM ELEVATOR BALLENGER.....	439	SKIN HOOK GILLIES.....	448
SCHMIEDEN-DICK LIGATUREE NEEDLE.....	219, 221	SEPTUM ELEVATOR COTTLE.....	439	SKIN HOOK GRAEFE.....	149
SCHMIEDEN-TAYLOR DURASSCISSORS.....	65/1	SEPTUM ELEVATOR COTTLE-JOSEPH.....	439	SKIN HOOK GUTHRIE.....	149
SCHNIDT TONSIL FORCEPS.....	467	SEPTUM ELEVATOR FREER.....	437	SKIN HOOK JOSEPH.....	149
SCHOENBORN THYROID GLAND HOOK.....	479	SEPTUM ELEVATOR HAJEK-BALLENGER.....	439	SKIN HOOK KILNER.....	608
SCHRÖDER HOOK FORCEPS.....	583, 584	SEPTUM ELEVATOR HALLE.....	437	SKIN HOOK KLEINERT-KUTZ.....	149
SCHRÖDER UTERINE CURETTE.....	595	SEPTUM ELEVATOR HOWARTH.....	438	SKIN HOOK REDA.....	150
SCHROEDER(POZZI) HOOK FORCEPS.....	582	SEPTUM ELEVATOR JOSEPH.....	437	SKIN SCISSORS.....	610
SCHUBERT BIOPSY FORCEPS.....	588	SEPTUM ELEVATOR KILLIAN.....	438	SKIN STRAIGHTENING BLADE FOR DERMATOME.....	49
SCHUKNECHT KNIVES.....	418	SEPTUM ELEVATOR MCKENTY.....	437, 438	SKIN-PUNCH KEYE.....	608
SCHULTZE SALPINGOGRAPH.....	596	SEPTUM ELEVATOR PENNINGTON.....	438	SKIN-PUNCH KEYE.....	608
SCHULZE-BERGMANN RECTAL-SPECULA.....	560	SEPTUM ELEVATOR PIERCE.....	438	SKLEROTOM GUYTON-LUNDSSGAARD.....	373
SCHUMACHER BIOPSY FORCEPS.....	588, 589	SEPTUM ELEVATOR ROGER.....	437	SKLEROTOM LUNDGAARD.....	373
SCHUMACHER EPISOTOMY SCISSORS.....	64	SEPTUM FORCEPS BRUENINGS.....	425	SLS CLIP FORCEPS.....	524
SCHUMACHER INTERCHANGEABLE TIPS.....	472	SEPTUM FORCEPS HEYMANN.....	425	SLUDER-BALLENGER.....	470
SCHUMACHER STERNUM SCISSORS.....	481	SEPTUM FORCEPS KNIGHT.....	425	SMELLIE HOOK.....	605
SCHWEIGGER CAPSULAR FORCEPS.....	391	SEPTUM FORCEPS LUC.....	426	SMELLIE PERFORATORS.....	607
SCISSORS CASTROVIEJO.....	79	SEPTUM FORCEPS MIDDLETON-JANSEN.....	430	SMILLIE BONE LEVERS.....	291
SCISSORS COTTLE.....	56	SEPTUM FORCEPS RUBIN.....	428	SMILLIE MENISCUSKNIVES.....	292
SCISSORS DOYEN.....	63	SEPTUM GOUGES FREER.....	442/1	SMITH EYE SPECULA.....	370
SCISSORS ENTEROTOMY.....	66	SEPTUM GOUGES HAJEK.....	442/1	SMITH SAGITTAL SPLIT RETRACTOR.....	463/5
SCISSORS ENUCLEATION.....	58	SEPTUM GOUGES KILLIAN-CLAUS.....	442/1	SMITH US ARMY BANDAGE SCISSORS.....	69/1
SCISSORS GORNEY.....	73	SEPTUM KNIVES CONVERSE.....	435	SMITH-BUIE ANAL RETRACTOR.....	561
SCISSORS GRAEFE.....	56	SEPTUM KNIVES COTTLE.....	435	SMITH-PETERSEN.....	261
SCISSORS HEPP-SCHIEDL.....	78	SEPTUM KNIVES FREER.....	434	SMITH-PETERSEN BONE RONGEUR.....	238
SCISSORS MARTIN CARTILAGE.....	65/1	SEPTUM KNIVES JOSEPH.....	434, 435	SMITHWICK APPLIERFORCEPS.....	326
SCISSORS MICRO.....	76	SEPTUM SCISSORS KILLIAN.....	471	SMITHWICK NERVE HOOK.....	328
SCISSORS NEUROSURGICAL.....	65	SEPTUM STRAIGHTENING FORCEPS ASCH.....	449	SNELLEN CATARACT LOOP.....	378
SCISSORS PARAMETRIUM.....	63	SEPTUM STRAIGHTENING FORCEPS WALSHAM.....	449	SNELLEN ENTROPOLIUM FORCEPS.....	393
SCISSORS REES.....	73	SERPENTINE BIOPSY FORCEPS.....	593	SOMER UTERINE-GRASPING FORCEPS.....	585
SCISSORS SIEBOLD.....	62	SEUTIN BANDAGE SCISSORS.....	69/2	SPAREBLADE.....	49
SCISSORS SIMS.....	62	SEXTON EAR KNIVES.....	408	SPAREBLADE STERILE.....	50
SCISSORS THOREK.....	65/2	SHAPLEIGH EAR LOOP.....	410	SPATULA.....	203, 612
SCISSORS WAGNER.....	67	SHAYER KNIVES.....	49	SPATULA AND PACKER.....	612
SCISSORS WERTHEIM.....	63	SHEA MICRO-EAR SCISSORS.....	413	SPATULA HIRSCHMAN.....	379
SCOVILLE BONE CURETTE.....	253	SHEEHAN CHISELS.....	441	SPECULA FRIEDMANN.....	577
SCOVILLE HOOK.....	196	SHEETS EYE CANNULA.....	394/2	SPECULA KALLMORGEN.....	573
SCOVILLE LAMINECTOMY RETRACTORRETRACTOR.....	196	SICKLE KNIVES REDA.....	435	SPECULA KRISTELLER.....	572

SPECULA O'SULLIVAN-O'CONNOR.....	576	STILLE RIB SCISSORS.....	480	SURGICAL SCISSORS STANDARD.....	51
SPENCER SUTURE SCISSORS.....	66	STILLE SURGICAL TISSUE FORCEPS.....	81	SURGICAL SCISSORS SYSTRUNK.....	66
SPENCER-WELLS HEMOSTATIC CLAMP.....	109	STILLE-BARRAYA VASCULARTISSUE FORCEPS.....	88	SURGICAL TISSUE FORCEPS.....	81/2
SPHYGMOMANOMETER BABYPHON.....	10	STILLE-HORSLEY BONE CUTTING FORCEPS.....	242	SURGICAL TISSUE FORCEPS ADSON.....	81/2
SPHYGMOMANOMETER DIPLOMAT.....	5	STILLE-LISTON BONE CUTTING FORCEPS.....	241	SURGICAL TISSUE FORCEPS ADSON MICRO.....	81/2
SPHYGMOMANOMETER EXACTA.....	8	STILLE-LUER BONE RONGEUR.....	239	SURGICAL TISSUE FORCEPS ADSON-BROWN.....	82
SPHYGMOMANOMETER MINIMUS.....	11, 12	STILLE-RUSKIN BONE RONGEUR.....	239	SURGICAL TISSUE FORCEPS BONNEY.....	88
SPHYGMOMANOMETER NOVA.....	6, 7	STILLE-SHERMAN BONE HAND DRILLS.....	298	SURGICAL TISSUE FORCEPS BROPHY.....	84
SPHYGMOMANOMETER PRECISA.....	9	STOCKMANN PENISCLAMP.....	553/1	SURGICAL TISSUE FORCEPS CUSHING.....	83
SPINAL BONE CURETTES.....	253	STOMACH CLAMP LANE.....	547	SURGICAL TISSUE FORCEPS FERRIS-SMITH.....	85
SPINAL HOOK TAYLOR.....	291	STOMACH-/BOWEL SUTUREING APPARTUS V.PETZ.....	549	SURGICAL TISSUE FORCEPS GERALD.....	87
SPINA-NASALIS RETRACTOR.....	461	STOMACH-BOWEL CLAMP MIKULICZ.....	543	SURGICAL TISSUE FORCEPS GILLIES.....	86
SPLINTERFORCEPS ARCHER.....	92	STONE FORCEPS.....	545	SURGICAL TISSUE FORCEPS LANE.....	84
SPLINTERFORCEPS PEET.....	92	STONE HOLDING CLAMP.....	545	SURGICAL TISSUE FORCEPS OEHLER TC.....	81/1
SPLINTERFORCEPS VIRTUS (RALK).....	92	STRABISMUS FORCEPS BONACCOLTO.....	385	SURGICAL TISSUE FORCEPS POTTS SMITH.....	81
SPLINTERFORCEPSSIEGLITZ.....	92	STRABISMUS FORCEPS DASTOOR.....	386	SURGICAL TISSUE FORCEPS SEMKEN.....	86
SPLINTERTISSUE FORCEPS.....	91	STRABISMUS FORCEPS JAMESON.....	385	SURGICAL TISSUE FORCEPS STILLE.....	81
SPLINTERTISSUE FORCEPS CARMALT.....	91	STRABISMUS FORCEPS MCCULLOUGH.....	385	SURGICAL TISSUE FORCEPS TAYLOR.....	87
SPLINTERTISSUE FORCEPS FEILCHENFELD.....	91	STRABISMUS HOOK GRAEFE.....	375	SURGICAL TISSUE FORCEPS TYPE USA.....	81/1
SPLINTERTISSUE FORCEPS HUNTER.....	91	STRABISMUS HOOK JAMESON.....	375	SURGICAL TISSUE FORCEPS WAUGH.....	83
SPOON MEDICINE.....	621	STRANDELL-STILLE RETRACTOR.....	157	SUTUREFORC REDA.....	221
SPRATT BONE CURETTES.....	251	STRASSBURGER TISSUE FORCEPS.....	89	SUTURESCISSORS HEALTH.....	66
SPREADER DAVIS-BOYLE.....	455	STRATTE NEEDLE HOLDER.....	212	SUTURESCISSORS LITTAUER.....	66
SPREADER DAVIS-MEYER.....	457	STRAUSS PENISCLAMP.....	553/1	SUTURESCISSORS NORTHBENT.....	66
SPREADER DINGMANN.....	456	STRIPPER.....	202	SUTURESCISSORS SPENCER.....	66
SPREADER KILNER-DOUGHTY.....	456	STRULLY NEUROSURGICAL.....	65	SUTURING SET.....	225
SPURLING LAMINECTOMY RETRACTOR FORCEPS.....	340	STRUYCKEN NOSE FORCEPS.....	427	SWEET APPLIERFORCEPS.....	326
SPUTUM CUP.....	621	SUBRAMANIAN-MINIATURE.....	521	SYSTRUNK SURGICAL SCISSORS.....	66
SREWHOLDINGFORCEPS LANE.....	325	SUCTION -IRRIGATION CANNULA.....	394		
ST.CLAIR-THOMSON ADENOID CURETTE.....	450	SUCTION HANDLE WULLSTEIN.....	338	T	
ST.MARKS PELVIS-HOOK.....	165	SUCTION RASPATORIES GUILLEN.....	433/1	TABB KNIVES.....	418
ST.MARTIN TISSUE FORCEPS.....	392	SUCTION TUBE ADSON.....	337	TABLET TRAY.....	621
STACKE EARPROBES.....	199	SUCTION TUBE ANDREW-PYNCHON.....	28	TAKAHASHI NOSE FORCEPS.....	427
STAMMBERGER FORCEPS.....	431	SUCTION TUBE BABY-YANKAUER.....	27	TANGENTIALCLAMP DEBAKEY-SATINSKY.....	502
STAND.....	188	SUCTION TUBE BARON.....	336	TARNIER CRANIPLAST.....	607
STANDARD SURGICAL SCISSORS.....	51	SUCTION TUBE COOLEY.....	28	TARNIER OBSTETRICAL FORCEPS.....	604
STAUDE-MOORE HOOK FORCEPS.....	582	SUCTION TUBE DASTOOR.....	380	TAYLOR PERCUSSION HAMMER.....	24
STEINMANN ENDER NAIL.....	307, 308	SUCTION TUBE DEBAKEY.....	28	TAYLOR SPINAL HOOK.....	291
STEINMANN TENDON HOLDINGFORCEPS.....	292	SUCTION TUBE FRAZIER/FERGUSSON.....	337	TAYLOR SURGICAL TISSUE FORCEPS.....	87
STELLBRINK BONE RONGEUR.....	234	SUCTION TUBE PLESTER.....	338	TC SCISSORS FREEMAN.....	74
STERILE SCALPEL.....	43	SUCTION TUBE POOLE.....	27	TC SCISSORS PECK-JOSEPH.....	74
STERILE SCALPEL-BLADE.....	42	SUCTION TUBE ROSEN.....	338	TC SCISSORS REES.....	73
STERILE SPARE BLADE.....	50	SUCTION TUBE TUBE KLEINSASSER.....	36	TC SURGICAL SCISSORS FINE REYNOLDS TC.....	54
STERILIZATION CLAMP BUNT.....	227	SUCTION TUBE YANKAUER.....	27	TC SURGICAL SCISSORS STANDARD.....	51
STERILIZATION CLAMP MAYO.....	227	SUCTION TUBE YASARGIL.....	337/1	TC TISSUE FORCEPS CUSHING.....	83
STERILIZATION FORCEPS.....	227	SUCTION TUBE ZOELLNER.....	337/1	TC TISSUE FORCEPS GILLIES.....	86
STERILIZATION FORCEPS.....	227	SUCTION TUBE HOUSE.....	337/2	TC TISSUE FORCEPS SEMKEN.....	86
STERILIZATION FORCEPS CHEATLE.....	227	SUPER CUT SCISSORS.....	71	TC TISSUE FORCEPS SURGICAL.....	81
STERILIZATION FORCEPS REDA.....	615	SUPER CUT SCISSORS BABY METZENBAUM.....	71	TC TISSUE FORCEPS WANGENSTEEN.....	89
STERILIZATION FORCEPS ROGGE.....	227	SUPER CUT SCISSORS FREEMAN.....	74	TC TISSUE FORCEPSON ANATOMIC.....	81
STERILIZATION FORCEPS UNIVERSAL.....	227	SUPER CUT SCISSORS GORNEY.....	73	TC-SCISSORS GORNEY.....	73
STERILIZATION TRAY.....	622, 623	SUPER CUT SCISSORS IRIS.....	72	TC-SCISSORS KAYE.....	73
STERILIZATION TRAY.....	616, 618	SUPER CUT SCISSORS KAYE.....	73	TEALE HOOK FORCEPS.....	583
STERNBERG CHEEK RETRACTOR.....	453	SUPER CUT SCISSORS KILNER/RAGNELL.....	72	TEBBETTS RETRACTOR.....	197
STERNUM SCISSORS SCHUMACHER.....	481	SUPER CUT SCISSORS LAGRANGE.....	72	TEETH TISSUE FORCEPS LONDON-COLLEGE.....	93
STERNUMCHISELS LEBSCHKE.....	267	SUPER CUT SCISSORS LISTER.....	72	TEETH TISSUE FORCEPS MERIAM.....	93
STETHOSCOPE ANESTOPHON.....	23	SUPER CUT SCISSORS MAYO.....	71	TENDON GRASPING FORCEPS.....	293
STETHOSCOPE DUPLEX.....	23	SUPER CUT SCISSORS MAYO-STILLE.....	71	TENDON GRASPING FORCEPS JACKSON.....	292
STETHOSCOPE PINARD.....	23	SUPER CUT SCISSORS METZENBAUM.....	71	TENDON GRASPING FORCEPS LARSEN.....	292
STEVENS IRIS TISSUE FORCEPS.....	383	SUPER CUT SCISSORS REES.....	73	TENDON GRASPING INSTR KLEINERT-KUTZ.....	294
STEVENS LINSENHOOK.....	375	SUPER CUT SCISSORS REYNOLDS.....	72	TENDON GRASPING INSTRUMENT BRAND.....	293
STEVENS NEEDLE HOLDER.....	214	SUPER CUT SCISSORS STEVENS.....	72	TENDON GRASPING INSTRUMENT CAROLL.....	293
STEVENS OPHTHALMOLOGIC SCISSORS.....	58	SUPER CUT SCISSORS WAGNER.....	72	TENDON GUIDE BUNELL.....	294
STEVENS SUPERCUT SCISSORS.....	72	SURGICAL NEEDLE.....	222, 223	TENDON HOLDINGFORCEPSSTEINMANN.....	292
STEVENSON EYE SPECULA.....	371	SURGICAL NEEDLE KEITH.....	223	TENDON PASSING INSTR. BRAND.....	294
STIEGLITZ SPLINTERFORCEPS.....	92	SURGICAL NEEDLE KOENIG.....	223	TENDON PASSING INSTR. BUNNELL.....	292
STILLE ANATOMIC TISSUE FORCEPS.....	81	SURGICAL SCISSORS FERGUSSON.....	66	TERSON CAPSULAR FORCEPS.....	391
STILLE BONE HAND DRILLS.....	298	SURGICAL SCISSORS FINE IRIS.....	54	TESSIER RETRACTOR.....	463/3
STILLE CHISELS.....	260	SURGICAL SCISSORS FINE JOSEPH.....	54	T-HANDLE.....	300, 301
STILLE CHISELS.....	260	SURGICAL SCISSORS FINE KILNER.....	54	T-HANDLE HUDSON.....	300
STILLE GOUGES.....	260	SURGICAL SCISSORS FINE REYNOLDS.....	54	THOMAS UTERINE CURETTE.....	599
STILLE HEMOSTATIC CLAMP.....	122	SURGICAL SCISSORS FINE SANVENERO.....	54	THOMAS-GAYLOR BIOPSY FORCEPS.....	588
STILLE PLASTERSCISSORS.....	229	SURGICAL SCISSORS METZENBAUM.....	51, 54	THOMS-ALLIS BOWEL GRASPING FORCEPS.....	538

THOMSON-WALKER BLADDER RETRACTORS.....	552	TONSIL ELEVATOR HURD.....	465	TRAY UNIVERSAL.....	620
THORACIC SPREADER MERCEDES.....	489	TONSIL ELEVATOR LOPEZ-REINKE.....	465	TRELAT TONSIL NEEDLE.....	466
THOREK SCISSORS.....	65/2	TONSIL ELEVATOR YANKAUER.....	465	TRELAT VAGINAL SPECULA.....	571
THUDICUM NOSE SPECULA.....	421	TONSIL FORCEPS BALLENGER.....	467	TROCAR COAKLEY.....	204
THYROID GLAND HOOK SCHOENBORN.....	479	TONSIL FORCEPS BLOHMKE.....	467	TROCAR DOUGLAS.....	205
TIECK-HALLE NOSE SPECULA.....	423	TONSIL FORCEPS MARSCHIK.....	468	TROCAR LICHTWITZ.....	204
TILLEY EAR FORCEPS.....	411	TONSIL FORCEPS NEGUS.....	467	TROCAR NELSON.....	205
TILT MECHANIC.....	194	TONSIL FORCEPS SAWTELL.....	467	TROCAR OCHSNER.....	205
TIP FOR SUCTION TUBE.....	27	TONSIL FORCEPS SCHNIDT.....	467	TROCAR PIERCE.....	204
TISCHLER-DOWN BIOPSY FORCEPS.....	591	TONSIL FORCEPS TYDING.....	467	TROCAR UNIVERSAL.....	204
TISCHLER-KEVORKIAN BIOPSY FORCEPS.....	592	TONSIL FORCEPS WHITE.....	467	TROCARSTANDARD (NELSON).....	204
TISCHLER-MORGAN BIOPSY FORCEPS.....	591	TONSIL GRASPING FORCEPS COLVER.....	467	TROELTSCH EAR FORCEPS.....	424
TISCHLER-MORGAN BIOPSY FORCEPS.....	590, 591	TONSIL NEEDLE.....	470	TROEMNER PERCUSSION HAMMER.....	24
TISCHLER-UP BIOPSY FORCEPS.....	591	TONSIL NEEDLE CLAUß.....	466	TROUSSEAU TRACHEA DILATOR.....	476
TISSUE FORCEPS.....	90, 94	TONSIL NEEDLE DUPUY-WEISS.....	466	TROUSSEAU-BABY TRACHEA DILATOR.....	476
TISSUE FORCEPS ANATOMIC.....	81	TONSIL NEEDLE NAGER.....	466	TROUTMAN IRIS TISSUE FORCEPS.....	389
TISSUE FORCEPS BIPOLAR.....	630, 631	TONSIL NEEDLETRELAT.....	466	TROUTMAN IRIS TISSUE FORCEPS.....	384, 389
TISSUE FORCEPS BONNEY.....	88	TONSIL SCISSORS.....	59	TROUTMAN-CHRIS BLADEBREAKERS.....	45
TISSUE FORCEPS BROWN.....	83	TONSIL SCISSORS BOETTCHER.....	59	TUBAL CATHETER.....	596
TISSUE FORCEPS CASTROVIEJO.....	392	TONSIL SCISSORS DEAN.....	59	TUBBS AORTIC DILATOR.....	528
TISSUE FORCEPS DAVIS.....	227	TONSIL SCISSORS GOOD.....	59	TUBING ASSEMBLY.....	188
TISSUE FORCEPS DEBAKEY.....	99	TONSIL SCISSORS PRINCE.....	59	TUBING CLAMP HOFFMANN.....	624
TISSUE FORCEPS GERALD.....	86, 87	TONSIL SNARE BRUENINGS.....	468	TUBING CLAMP SIMPLEX.....	624
TISSUE FORCEPS GOMEL.....	96	TONSIL SNARE EVES.....	468	TUBINGCLAMP.....	129
TISSUE FORCEPS GRAEFE.....	83	TONSIL SYRINGE.....	470	TUBINGCLAMPBÜLOW-GUNAR-HEY.....	130
TISSUE FORCEPS JEWELRY.....	90	TONSIL WIRE.....	468	TÜBINGEN TISSUE FORCEPS.....	392
TISSUE FORCEPS MAYO.....	89	TONSIL-ELEVATOR HENKE.....	465	TUFFIER RETRACTOR.....	147
TISSUE FORCEPS MCPHERSON.....	392	TONSIL-KNIVES ABRAHAM.....	466	TUFFIER RIB SPREADER.....	487
TISSUE FORCEPS MOORFIELD.....	392	TONSIL-KNIVES BRUENINGS.....	466	TUFFIER TISSUE GRASPING FORCEPS.....	110
TISSUE FORCEPS PAUFIQUE.....	392	TONSIL-KNIVES CANFIELD.....	466	TUMOR GRASPING FORCEPS LANDOLT.....	341
TISSUE FORCEPS SINGLEY.....	88	TONSIL-KNIVES CARPENTER.....	465	TUMORTISSUE FORCEPS YASARGIL.....	97
TISSUE FORCEPS STRASSBURGER MODELL.....	89	TONSIL-KNIVES DOUGLAS.....	466	TUNING FORC.....	404
TISSUE FORCEPS TYPE TUEBINGEN.....	392	TONSIL-KNIVES FISHER.....	466	TUNING FORC HARTMANN.....	403
TISSUE FORCEPS ULTRA LIGHT.....	95	TONSILOTOME SLUDER-BALLENGER.....	470	TUNING FORC LUCAE.....	404
TISSUE FORCEPS WAGENSTEEN.....	89	TONSILOTOME TYDING.....	469	TUNING FORC REDA.....	403
TISSUE FORCEPS YASARGIL.....	97	TOOK CORNEAL SCARIFIER.....	373	TUNING FORC RYDEL-SEIFFERT.....	404
TISSUE FORCEPSST.MARTIN.....	392	TOURNIQUET RUMEL-BELMONT.....	528	TURNBULL NAIL FORCEPS.....	609
TISSUE GRASPING FORCEPS CHAPUT.....	110	TOWEL CLAMP.....	133	TURREL RECTAL BIOPSY FORCEPS.....	567
TISSUE GRASPING FORCEPS COLLIN.....	110	TOWEL CLAMP BACKHAUS.....	132	TYDING TONSIL FORCEPS.....	467
TISSUE GRASPING FORCEPS TUFFIER.....	110	TOWEL CLAMP BACKHAUS-CLIP.....	132	TYDING TONSILOTOME.....	469
TITANIUM CLIPS.....	549	TOWEL CLAMP BALL AND SOCKET.....	133	TYPE TÜBINGEN IRIS FORCEPS.....	387
TITANIUM HALSTED-MOSQUITO HEMOSTATIC CLAMP.....	105	TOWEL CLAMP BERNHARD.....	133	TYPE MÜNCHEN BIOPSY CURETTE.....	587
TITANIUM HEMOSTATIC CLAMP CRILE.....	107	TOWEL CLAMP DOYEN.....	133	TYPE VIENNA NOSE SPECULA.....	421
TITANIUM HEMOSTATIC CLAMP KELLY.....	106	TOWEL CLAMP JONES.....	132		
TITANIUM TISSUE FORCEPS DEBAKEY.....	99	TOWEL CLAMP JONES-CLIP.....	132	U	
TITANIUM-ATRAUMA-BULLDOG CLAMP.....	102	TOWEL CLAMP LANE.....	133	UCKERMANN COTTON-APPLICATOR.....	203
TOBOLD COTTON-APPLICATOR.....	203	TOWEL CLAMP LORNA.....	133	ULRICH BONE HOLDING FORCEPS.....	248
TOBOLD TONGUE DEPRESSORS.....	453	TOWEL CLAMP MOYNIHAN.....	133	ULRICH DRESSINGFORCEPS.....	135
TOENNIS DURA DISSECTOR.....	332	TOWEL CLAMP PEERS.....	132	ULTRA-LIGHT-TISSUE FORCEPS ATRAUMA.....	95
TOENNIS HEMOSTATIC CLAMP.....	117	TOWEL CLAMP ROEDER.....	132	UMBILICAL CORD SCISSORS BRAUN-STADLER.....	64
TOENNIS-ADSON DISSECTING SCISSORS.....	65	TOWEL CLAMP SCHAEDEL.....	132	UMBILICAL CORD SCISSORS BUSCH.....	64
TOHUKU TOWEL CLAMP.....	132	TOWEL CLAMP SCHAEDEL.....	132	UMBILICAL CORD SCISSORS SCHUMACHER.....	64
TONGUE BLADE DOUGHTY.....	458	TOWEL CLAMP TOHOKU.....	132	UMBILICAL CORD SCISSORS TYPE USA.....	64
TONGUE DEPRESSORS.....	451	TOWNLEY CALIPER.....	26	UNI I DIAGNOSTIK-BES.....	13
TONGUE DEPRESSORS ANDREW.....	452	TOWNSEND BIOPSY FORCEPS.....	591	UNI III DIAGNOSTIK-BES.....	15
TONGUE DEPRESSORS ANDREW.....	452	TOWNSEND MINI BIOPSY FORCEPS.....	591	UNIVERSAL BANDAGE SCISSORS.....	70
TONGUE DEPRESSORS BRUENINGS.....	451	TOYNEE EAR SPECULA.....	399	UNIVERSAL ENDOSCOPE ASSEMBLY.....	188
TONGUE DEPRESSORS BUCHWALD.....	451	TRACHEA CANNULA LUER.....	479	UNIVERSAL STERILIZATION FORCEPS.....	227
TONGUE DEPRESSORS DAVIS-BOYLE.....	455	TRACHEA CANNULA WAGENER-MOSHER.....	477	UNIVERSAL TRAY.....	620
TONGUE DEPRESSORS DINGMANN.....	456	TRACHEA CANNULACHEVALIER-JACK.....	479	UNIVERSAL TROCAR.....	204
TONGUE DEPRESSORS FRENZEL.....	451	TRACHEA DILATATOR. LABORDE.....	476	UNIVERSAL WIRESCISSORS.....	67
TONGUE DEPRESSORS HARTMANN.....	452	TRACHEA DILATOR. TROUSSEAU.....	476	UNIVERSALHANDLE HUBER.....	472
TONGUE DEPRESSORS KILNER-DOUGHTY.....	456	TRACHEA DILATORTROUSSEAU-BABY.....	476	UNNA COMEDONE EXTRACTOR.....	608
TONGUE DEPRESSORS KROENIG.....	451	TRACHEA HOOK BOSE.....	476, 477	URETHROTOME OTIS.....	553
TONGUE DEPRESSORS MAYO.....	451	TRACHEA HOOK ITERSON.....	477	US ARMY RETRACTOR.....	141
TONGUE DEPRESSORS MORITZ-SCHMIDT.....	452	TRACHEA HOOK JACKSON.....	476	USA ANATOMIC TISSUE FORCEPS.....	81
TONGUE DEPRESSORS RING.....	455	TRACHEA HOOK NEWS.....	477	USA TYPE UMBILICAL CORD SCISSORS.....	64
TONGUE DEPRESSORS RUSSEL-DAVIS.....	458	TRACHEOTOMY-SET.....	478	UTERINE CURETTE SIMON.....	594
TONGUE DEPRESSORS TOBOLD.....	453	TRACHOMA FORCEPS KNAPP-LUER.....	393	UTERINE CURETTE BLAKE.....	595
TONGUE DEPRESSORS WIEDER.....	452	TRANSFORMATOR.....	22	UTERINE CURETTE BUMM.....	597
TONGUE FORCEPS COLLIN.....	453	TRANSFORMER FOR LARYNGOSCOPE HANDLE.....	34	UTERINE CURETTE GOURDET STUMPF.....	599
TONGUE FORCEPS YOUNG.....	453	TRAVERS RETRACTORS.....	172	UTERINE CURETTE RECAMIER.....	597
TONOMETER SCHIÖETZ.....	394/2	TRAY.....	619	UTERINE CURETTE SCHRÖDER.....	595
TONSIL FORCEPS ABRAHAM.....	468				

UTERINE CURETTE SIMS .....	597	VERBRUGGE BONE HOLDING FORCEPS .....	245	WILLIAMS SCREW DRIVER .....	323
UTERINE CURETTE THOMAS .....	599	VERBRUGGE-MÜLLER BONE LEVERS .....	287	WILLIGER CURETTE .....	255, 257
UTERINE DILATATOR GOODELL .....	581	VERESS INSUFFLATION CANNULA .....	206	WILLIGER HAMMER .....	271
UTERINE DILATATOR HANK .....	580	VIENNA GUIDEPROBES .....	221	WILLIGER RASPATORIES .....	276
UTERINE DILATATOR HEGAR .....	578, 579	VIRCHOW POST MORTEM KNIVES .....	48	WINTER OVUM FORCEPS .....	606
UTERINE DILATATOR PRATT .....	580	VIRTUS(RALK) SPLINTERZ .....	92	WIRE BASKET FOR ENDOSCOPE .....	623
UTERINE DILATATOR SIMS .....	581	VOLKMANN BONE CURETTES .....	251	WIRE FORCEPS .....	317, 318
UTERINE DILATATOR WYLLIE .....	581	VOLKMANN CURETTE .....	257	WIRE FORCEPS BERRY TC .....	319
UTERINE POLYP FORCEPS DOYEN .....	585	VOLKMANN RETRACTOR .....	153	WIRE FORCEPS CORWIN-HEGAR TC .....	319
UTERINE POLYP FORCEPS KELLY .....	585	VOLKMANN RETRACTOR .....	153, 156	WIRE FORCEPS MAYO-HABERISSER TC .....	319
UTERINE POLYP FORCEPS NOTO .....	585	VOLTOLINI NOSE SPECULA .....	421	WIRE GAUZE .....	311
UTERINE-DEPRESSOR BRAUN .....	586	VU-MORE VAGINAL SPECULA .....	569	WIRE GRASPING FORCEPS .....	318
UTERINE-DEPRESSOR SIMS .....	586			WIRE GUIDE NEEDLE DEMEL .....	315
UTERINE-GRASPING FORCEPS COLLIN .....	585	W		WIRE INSTRUMENT DEMEL .....	315
UTERINE-GRASPING FORCEPS DARTIGUES .....	585	WACHENFELDT CLIP TISSUE FORCEPS .....	224	WIRE INSTRUMENT LOUTE .....	315
UTERINE-GRASPING FORCEPS SOMER .....	585	WADSWORTH-TODD CAUTER .....	378	WIRESAW OLIVECRONA .....	332
UTERINE-KL.FORCEPSGREEN-ARMYTAGE .....	605	WAGENER-MOSHER TRACHEA CANNULA .....	477	WIRESCISSORS UNIVERSAL .....	67
UTERINE-PROBES COLLIN .....	586	WAGNER HOOK .....	409	WITNER BIOPSY FORCEPS .....	589
UTERINE-PROBES MARTIN .....	586	WAGNER LAMINECTOMY RETRACTOR FORCEPS .....	343	WOLFF PLASTER FORCEPS .....	233
UTERINE-PROBES SIMS .....	586	WAGNER SCISSORS .....	67	WOODSON DURA DISSECTOR .....	333
		WAGNER SUPERCUT SCISSORS .....	72	WORST PROBES .....	333
V		WALDMANN EPISOTOMY SCISSORS .....	64	WOUND CURETTE ARRUGA .....	378
VAGINAL SPECULA .....	569	WALLICH OVUM CURETTE .....	607	WRIGLEY OBSTETRICAL FORCEPS .....	602
VAGINAL SPECULA JACKSON .....	573	WALSHAM SEPTUM STRAIGHTENING FORCEPS .....	449	WULLSTEIN KNIVES .....	418
VAGINAL SPECULA AUVARD .....	576	WALTON FOREIGN-BODY GOUGES .....	374	WULLSTEIN MICRO-CURETTE FORCEPS .....	416
VAGINAL SPECULA BREISKY .....	577	WALTON COMEDONE EXTRACTOR .....	608	WULLSTEIN RETRACTORS .....	171
VAGINAL SPECULA COLLIN .....	570	WALTON FINGER RING SAW .....	297	WULLSTEIN SUCTION HANDLE .....	338
VAGINAL SPECULA CUSCO .....	570	WANGENSTEEN VASCULARTISSUE FORCEPS .....	89	WYLLIE UTERINE DILATOR .....	581
VAGINAL SPECULA DOYEN .....	574	WARTENBERG PINWHEEL .....	25		
VAGINAL SPECULA GRAVE .....	570	WASTEFORCEPS SAUERBRUCH .....	227	Y	
VAGINAL SPECULA KRISTELLER .....	572	WATER JET PISTOL .....	626	YANCOSKIE RETRACTOR .....	198
VAGINAL SPECULA LANDAU .....	577	WATSON DERMATOM .....	50	YANKAUER SUCTION TUBE .....	27
VAGINAL SPECULA PEDERSON .....	570	WATSON DERMATOM .....	50	YANKAUER TONSIL DISSECTOR .....	465
VAGINAL SPECULA SEMM .....	571	WATSON-CHEYNE .....	283	YASARGIL ANEURYSM .....	349, 350, 351, 352, 353, 354, 355, 356
VAGINAL SPECULA SIMS .....	573	WATSON-CHEYNE PROBES .....	199	YASARGIL GALEAHOOK .....	330
VAGINAL SPECULA TRELAT .....	571	WATSON-WILLIAMS NOSE FORCEPS .....	428	YASARGIL SUCTION TUBE .....	337/1
VAGINAL SPECULA VU-MORE .....	569	WAUGH SURGICAL TISSUE FORCEPS .....	83	YASARGIL TUMORTISSUE FORCEPS .....	97
VAGINAL SPECULASCHERBAK .....	575	WEBER BLOOD VESSEL CLAMP .....	501	YEOMAN RECTAL BIOPSY FORCEPS .....	566, 567
VALLEIX PROBES .....	586	WEBER CATARACT LOOP .....	378	YOUNG BOOMERANG .....	220
VAN BUREN BONE HOLDING FORCEPS .....	249	WEBSTER NEEDLE HOLDER .....	208	YOUNG PROSTATIC HOOK .....	550
VAN BUREN DILATION BOUGIE .....	554	WECKER EYECISSORS .....	75	YOUNG TONGUE FORCEPS .....	453
VAN DOREN BIOPSY FORCEPS .....	588	WECKER IRIS SPATULA .....	378		
VANNAS EYECISSORS .....	79	WEEK EYE SPECULA .....	370	Z	
VARADY VARIX INSTRUMENT .....	202	WEIL-BLAKESLEY NOSE FORCEPS .....	426	ZAUFAL EAR LEVER .....	409
VARICOSE VEIN PROBES NABATOFF .....	201	WEITLANER RETRACTORS .....	169	ZAUFAL-JANSEN BONE RONGEUR .....	238
VARIX INSTRUMENT VARADY .....	202	WEITLANER-WULLSTEIN RETRACTORS .....	169	ZAUFAL-JANSEN EAR LEVER .....	409
VASCULAR CLAMP BAINBRIDGE .....	495	WELLER DISSECTING SCISSORS .....	53/2	ZENKER HEMOSTATIC CLAMP .....	118
VASCULAR CLAMP COOLEY .....	518, 522	WELLS ENUCLATION CURETTE .....	378	ZENKER RETRACTOR .....	161
VASCULAR CLAMP DE BAKEY .....	495	WERTHEIM GYNECOLOGICAL SCISSORS .....	63	ZIEGLER DISCISION KNIVES .....	373
VASCULAR CLAMP DEBAKEY .....	507, 514, 515	WERTHEIM HYSTERECTOMY CLAMP .....	124, 128	ZIEGLER EYE SPECULA .....	371
VASCULAR CLAMP DEBAKEY CHILDREN .....	516	WERTHEIM HYSTERECTOMY SCISSORS .....	63	ZIEGLER HEAD MIRRORS .....	371
VASCULAR CLAMP GLOVER .....	515	WERTHEIM-CULLEN HYSTERECTOMY CLAMP .....	125	ZIEGLER IRIS KNIVES .....	21
VASCULAR CLIP BIEMER .....	361	WEST NOSE CHISELS .....	442	ZIEGLER IRIS KNIVES .....	372
VASCULAR CLIP MEHDORN .....	362	WESTCOTT EYECISSORS .....	75	ZIEGLER LACHRYMAL DILATOR .....	381
VASCULAR CLIP MUELLER .....	365	WESTMACOTT NOSE DRESSING FORCEPS .....	424	ZIELKE GOUGES .....	264
VASCULAR SCISSORS DE BAKEY .....	61	WESTON RECTALSNARE .....	566	ZOELLNER SUCTION TUBE .....	337/1
VASCULAR SCISSORS DEBAKEY TC .....	60	WHEELER CYCLODIALYSIS SPATULA .....	379		
VASCULAR SCISSORS DIETRICH .....	60	WHEELER DISCISION KNIVES .....	373		
VASCULAR SCISSORS FAVALORO .....	61	WHITE TONSIL FORCEPS .....	467		
VASCULAR SCISSORS KELLY .....	61	WIBERG RASPATORIESIUM .....	277		
VASCULAR SCISSORS POTTS-SMITH .....	61	WIEDER TONGUE DEPRESSORS .....	452		
VASCULAR-CANNULA SCHMID .....	338	WIENER ANTRUM RASP .....	443		
VASCULAR-DILATOR DEBAKEY .....	529	WIENER IRIS HOOK .....	375		
VASCULARDISSECTOR ROBB .....	530	WIGMORE PLASTER KNIVES .....	229		
VASCULARSCISSORS KLINKENBERG-LOTH .....	65/2	WIKSTROEM HEMOSTATIC CLAMP .....	117		
VASCULARSCISSORS POTTS-DE MARTEL .....	59	WILDE POLYP SNARE .....	411		
VASCULARSCISSORS SATINSKY .....	65/1	WILDE POLYP SNARE .....	433/2		
VASCULARSCLAMP DIEFFENBACH .....	104	WILDE(TROELTSCH) EAR FORCEPS .....	410		
VASCULARSCLAMP SATINSKY .....	491	WILDER PROBE .....	381		
VASCULARTISSUE FORCEPS ADLERKREUTZ .....	84	WILDER CATARACT LOOP .....	378		
VASCULARTISSUE FORCEPS NELSON .....	89	WILLET MARTEL GRASPING FORCEPS .....	110		
VASCULARTISSUE FORCEPSSTILLE-BARRAYA .....	88	WILLIAMS BOWEL GRASPING FORCEPS .....	539		
VASEKTOMIECLAMP .....	553/2	WILLIAMS EYE SPECULA .....	370		

Abraham bisturi para amígdalas.....	466
Abraham pinza para coger amígdalas.....	468
abre-boca Davis-Boyle.....	455
abre-boca Davis-Meyer.....	457
abre-boca Denhart.....	454
abre-boca Dingmann.....	456
abre-boca Doyen-Jansen (Molt).....	454
abre-boca Heister.....	454
abre-boca Jennings.....	454
abre-boca Kilner-Doughty.....	456
abre-boca Mclvor.....	457
abre-boca Roser-Koenig.....	454
aceite para instrumentos Instru Care.....	634
adaptador para iluminación para amioscopio.....	600
adenotomo LaForce.....	450
Adlerkreutz pinza de disección.....	84
Adson Baby pinza hemostática.....	113
Adson elevador.....	282
Adson gancho para dura-madre.....	329
Adson pinza de disección.....	81/2, 82
Adson pinza de protección.....	298
Adson pinza gubia.....	236
Adson pinza hemostática.....	112, 113
Adson pinza para hipofisis.....	334
Adson porta aguja.....	211
Adson separador.....	172, 173, 174
Adson tubo de aspiración.....	337
Adson-Brown pinza de disección.....	82
AEBL tija corneal.....	58
agrafe MICHEL.....	224
aguja Barbara.....	419
aguja de discisión Bowman.....	374
aguja de guía para anestesia.....	206
aguja de guía REDON.....	207
aguja para amígdalas.....	470
aguja para autopsia.....	268
aguja para biopsia Franklin-Silvermann.....	206
aguja para biopsia Menghini.....	206
aguja para catarata.....	374
aguja para cuerpos extraños.....	374
aguja para cuerpos extraños Davis.....	374
aguja para cuerpos extraños Francis.....	374
aguja para cuerpos extraños Levinson.....	374
aguja para laringe.....	470
aguja para ligadura.....	218, 219
aguja para ligadura Cooper.....	219
aguja para ligadura Deschamps.....	218
aguja para ligadura Kronecker.....	219
aguja para ligadura Nelson.....	219
aguja para ligadura Schmieden-Dick.....	219
aguja para neumoperitoneo Verres.....	206
aguja para paracentesis Lucae.....	408
aguja para paracentesis Politzer.....	408
aguja para sutura amígdalas Dupuy-Weiss.....	466
aguja para sutura del paladar Claus.....	466
aguja para sutura del paladar Claus-Eicken.....	466
aguja para sutura del paladar Nager.....	466
aguja pasa-hilo Demel.....	315
aguja Reverdin.....	220
aguja Yound Boomerang.....	220
agujas de sutura.....	222, 223
Air Injection canula.....	394
alambre de Kirschner.....	306, 307
alambre de Steinmann.....	307, 308
alambres.....	306, 307, 308, 309
Alan-Parks espejuelo rectal.....	561
Alderdyce elevador.....	282
Alexander cincel.....	259
Alexander gubia.....	259
Alexander periototomo.....	276
Alexander pinza para biopsia.....	589
alicate corta-uñas.....	609, 612/2, 613, 614
alicate corta-uñas Anvil.....	613
alicate cuticular.....	613
alicate Grip.....	316
alicate para cortar uñas Turnbull.....	609
alicates.....	316-318, 320
alicates para cortar alambres.....	316-318, 320
Allen pinza para apéndice.....	544
Allis pinza intestinal.....	537
Allis-Adair pinza intestinal.....	537
Allis-Baby pinza intestinal.....	537
Allison espátula pulmonar.....	489
Alm separador.....	168
Alvis cureta para cuerpos extraños.....	374
amigdalotomo Sluder-Ballenger.....	470
amigdalotomo Tyding.....	469
amniotomo.....	586, 600
amniotomo Beacham.....	586
Anderson Adson separador.....	172
Anderson separador.....	198
Andrew baja-lengua.....	452
ANDREW-PYNCHON tubo de aspiración.....	28
ANESTOPHON estetoscopio.....	23
anillo para KLEINSASSER.....	36
anoscopio Chelsea-Eaton.....	563
anoscopio Hirschmann.....	562
anoscopio Ives-Fansler.....	562
anteojos para nistagmo FRENZEL.....	20
Antrum cureta.....	435
Anvil alicate corta-uñas.....	613
aparato para suturar estomago y intestinos V. Petz.....	549
aproximador de Biemer.....	366
aproximador de Biemer-Müller.....	363
aproximador de Müller.....	364
aproximador para costillas Bailey.....	489
aproximador para costillas Bailey-Baby.....	489
aproximador para costillas Bailey-Gibbon.....	489
Archer pinza para espinas.....	92
Arit asa.....	378
Arruga blefarostato.....	370
Arruga gancho para extracción.....	375
Arruga pinza capsular.....	391
Arruga porta aguja.....	214
Arruga protector.....	378
articulación para KLEINSASSER.....	36
asa Arit.....	378
asa Billeau.....	409
asa Langenbeck.....	409
asa Shapleigh.....	410
asa Snellen.....	378
asa Weber.....	378
asa Wilder.....	378
Asch pinza para enderezar el tabique nasal.....	449
Aufranc-Cobra separador.....	289
Aufricht lima nasal.....	443
Aufricht retractor nasal.....	447
Auvard espejuelo vaginal.....	576
Axenfeld cucharilla para chalazión.....	377
Ayer pinza para ligadura.....	393
B.....	
Babcock pinza intestinal.....	539
BABINSKI martillo de percusión.....	24
Baby Burke pinza para biopsia.....	590
Baby Gosset separador abdominal.....	181
Baby Metzenbaum tijera supercut.....	71
Baby-Kocher pinza intestinal.....	540
Baby-Olsen-Hegar porta aguja.....	212
BABYPHON esfigmomanómetro.....	10
Baby-Tischler pinza para biopsia.....	592
BABY-YANKAUER tubo de aspiración.....	27
Back holder separador abdominal.....	192, 193, 194, 195
Backhaus pinza de campo.....	132
Backhaus-Clip pinza de campo.....	132
Bailey aproximador para costillas.....	489
Bailey-Baby aproximador para costillas.....	489
Bailey-Gibbon aproximador para costillas.....	489
Bainbridge pinza hemostática.....	119/2
Bainbridge pinza vascular de uso múltiple.....	495
baja-lengua Andrew.....	452
baja-lengua Bruenings.....	451
baja-lengua Buchwald.....	451
baja-lengua Cawood-Minnesota.....	451
baja-lengua Doughty.....	458
baja-lengua Frenzel.....	451
baja-lengua Hartmann.....	452
baja-lengua Kroenig.....	451
baja-lengua Mayo.....	451
baja-lengua Moritz-Schmidt.....	452
baja-lengua Ring.....	455
baja-lengua Russel-Davis.....	458
baja-lengua Tobold.....	453
baja-lengua Wieder.....	452
baja-lengua.....	451, 452, 453, 455
Bakes dilatador para conductos biliares.....	532
Balfour Baby separador abdominal.....	182, 183
Balfour separador abdominal.....	182, 183
Balfour-Us separador abdominal.....	184
Ball and Socket pinza para campo.....	133
Ballenger cuchillo para tabique nasal.....	436
Ballenger elevador para el tabique nasal.....	439
Ballenger pinza para coger amígdalas.....	467
bandejas.....	620
Bane-Hartmann pinza gubia.....	237
Bangerter espátula para ciclodialisis.....	379
Baracani punta de pinza.....	472
Barany ensordecedor.....	405
Barbara aguja.....	419
Barbara gancho.....	419
Barkan cuchillo para goniotomía.....	373
Barnhill cuchillo para vegetaciones adenoides.....	450
Baron canula de succión.....	336
Barr espejuelo rectal.....	559
barra de tracción Gerster.....	250
Barraquer (Colibrí) blefarostato.....	370
Barraquer (Colibrí) pinza para iris.....	384
Barraquer Colibrí tijera para oftalmología.....	75
Barraquer cuchillo para queratoplastia.....	373
Barraquer micro porta aguja.....	216, 217
Barraquer pinza depilatoria.....	395
Barraquer pinza para fijación.....	390
Barraquer-Katzin pinza para iris.....	384
Barraquer-Troutmann micro porta aguja.....	216
Barrett pinza uterina.....	582
Barton forceps obstétrico.....	603
Barton tractor.....	603
Baumgartner porta aguja.....	208
Beacham amniotomo.....	586
Becher rotador.....	379
Beck pinza para anastomosis.....	516, 520
Becker quistotomo.....	375
Beckmann cuchillo para vegetaciones adenoides.....	450
Beckmann separador.....	176
BECKMANN-ADSON separador.....	175
Beckmann-Eaton separador.....	176
Beebee tijera para coronas.....	68
Beer pinza depilatoria.....	395
Beeson separador para yesos.....	232
Bellucci tijera aurícula micro.....	413, 417
Bengolea pinza hemostática.....	112
Bennett elevador.....	283
Bensaude protoscopio.....	565
Benson separador para piloro.....	544
Berens cuchillo de discisión.....	372
Bergmann martillo.....	272
Bergmann tijera para vendaje.....	69/1

Berke pinza muscular.....	389	Bozemann-Douglas pinza porta esponja.....	138	canula irrigacion Eicken (Killian).....	433
BERLINER martillo de percusion.....	24	Brand mondador de tendones.....	294	canula Killian.....	433/1
Bernhard pinza de campo.....	133	Brand pinza de agarre para tendones.....	293	canula Lacrimal.....	394
Berry pinza para torcer hilo.....	319	Braun cranioclasto.....	607	canula lacrimal McIntyre.....	394
Bethune costotomo.....	481	Braun depresor uterino.....	586	canula para lavador vascular Schmid.....	338
Beyer pinza gubia.....	237, 238	Braun gancho de decapitacion.....	607	canula para traqueotomia Chevalier-Jackson.....	479
Biemer aproximador.....	366	Braun pinza uterina.....	582	canula para traqueotomia Luer.....	479
Biemer pinza para vasos.....	361	Braun-Stadler tijera para episiotomia.....	64	canula para traqueotomia Wagener-Mosher.....	477
Biemer-Müller aproximador.....	363	brazalete para brazo.....	295	canula Sheets.....	394/2
Bier sierra para amputacion.....	296	brazalete para femur.....	295	canula Simcoe.....	394/2
Bill tractor.....	604	Breast separador mamario.....	198	Carmalt pinza para espinas.....	91
Billeau asa.....	409	Breisky especulo vaginal.....	577	Caroli pinza de agarre para tendones.....	293
Bircher-Ganske pinza para hueso.....	246	Bridge pinza hemostatica.....	116	Carpenter cuchillo para amigdales.....	465
Birkett pinza hemostatica.....	116	Bristow elevador.....	290	Caspar hemostatico.....	258
Bishop-Harman pinza para iris.....	386	Brodie sonda acanalada.....	199	Caspar separador.....	179, 180
Bishop-Harmon canula de irrigacion y aspiracion.....	394/1	Brophy pinza de diseccion.....	84	Castaneda pinza vascular para neonatales.....	527
bisturi nasal Joseph.....	434, 435	Brown pinza de diseccion.....	83	Castroviejo bleararostato.....	371
bisturi para amigdalas Abraham.....	466	Brown porta aguja.....	209	Castroviejo compas marcador.....	380
bisturi para amigdalas Bruenings.....	466	Bruenings baja-lengua.....	451	Castroviejo cuchillo para discision.....	372
bisturi para amigdalas Canfield.....	466	Bruenings bisturi para amigdalas.....	466	Castroviejo dilatador lacrimal.....	381
bisturi para amigdalas Douglas.....	466	Bruenings cierranudos.....	468	Castroviejo espátula para ciclodialisis.....	379
bisturi para amigdalas Fisher.....	466	Bruenings especulo auricular.....	401	Castroviejo pinza capsular.....	391
bisturi para fibroma Segond.....	594	Bruenings pinza nasal.....	425	Castroviejo pinza para fijacion.....	390
bisturios.....	46	Bruenings punta de pinza.....	472	Castroviejo pinza para sutura.....	392
Blake curetas uterinas.....	595	Bruenings tubo de extension.....	472	Castroviejo porta aguja.....	215
Blake pinza para calculos biliares.....	531	Brunetti cincel.....	268	CASTROVIEJO rompe hojas.....	45
blefarostato Arruga.....	370	Brünings-Lucas cincel.....	260	Castroviejo tijera para corneales.....	79
blefarostato Barraquer (Colibr).....	370	Brünings-Lucas gubia.....	260	Castroviejo tijera para iridectomia.....	79
blefarostato Bowman.....	370	Brunner costotomo.....	481	Castroviejo-Micro porta aguja.....	215
blefarostato Clark.....	370	Brunner pinza intestinal.....	543	Castroviejo-Standard micro porta aguja.....	216
blefarostato Critchett.....	370	Brunner separador.....	167	cateter auricular Hartmann.....	408
blefarostato Graefe.....	370	Brunner sonda conductora.....	221	cateter Coxeter.....	555
blefarostato Lancaster.....	371	Bruns cucharilla cortante.....	251, 254	cateter metalicos.....	555
blefarostato Lister-Burch.....	370	Bruns tijera para vendaje.....	70	CATLIN cuchillo para amputacion.....	44
blefarostato Mellinger.....	370	Bryant pinza para medicacion.....	137	cauterio Wadsworth-Todd.....	378
blefarostato Mellinger-Axenfeld.....	370	Buchwald baja-lengua.....	451	Cawood-Minnesota baja-lengua.....	451
blefarostato Murdoch.....	370	Buck cureta.....	407	cepillo para uñas.....	611
blefarostato Smith.....	370	Buck elevador para cuerpos extraños.....	412	cesta de esterilizacion.....	621, 623
blefarostato Week.....	370	BUCK martillo de percusion.....	24	Chandler elevador.....	282
blefarostato Williams.....	370	Buck-Gramcko elevador.....	285	Chaput pinza hemostatica.....	110
blefarostato Ziegler.....	371	Buie canula de aspiracion rectal.....	566	Charley separador abdominal.....	289
blearostato Castroviejo.....	371	bujia dilatadora Dittel.....	554	Charriere sierra para amputacion.....	296
blearostato Liebermann.....	371	bujia dilatadora Guyon.....	554	Cheatle pinza para esterilizacion.....	227
blearostato Mueller.....	371	bujia dilatadora Van Buren.....	554	Chelsea-Eaton anoscopio.....	563
blearostato Park.....	371	Bülow-Gunar-Hey pinza cierra-tubo.....	130	Cheron pinza porta esponja.....	137
blearostato Stevenson.....	371	Bumm curetas uterinas.....	597	Cherry separador para laminectomia.....	488
Blohmke pinza para coger amigdalas.....	467	Bunell pasador de tendones.....	294	Chevalier-Jackson canula para traqueotomia.....	479
Blount elevador.....	288	Buneli perforador de mano.....	299	Chevalier-Jackson pinza para bronco-esofagoscopia.....	473
Blount separador para rodilla.....	289	Bunell separador para tendones.....	292	Childe pinza para aplicar agrafes.....	224
Blumenthal pinza gubia.....	236	Bunge cucharilla para exenteracion.....	378	cierra-nudo auricular Krause.....	411
Bodenhammer especulo rectal.....	559	Bunt clip para esterilizacion.....	227, 624	cierra-nudo auricular Wilde.....	411
Boerma forceps obstetrico.....	604	Burch horquilla fijadora.....	373	cierra-nudo rectal Yeoman.....	566
BOETTCHER tijera para amigdalas.....	59	Burke pinza para biopsia.....	590	cierranudos Bruenings.....	468
Böhler estribo para extension.....	312	Busch tijera para cordon umbilical.....	64	cierranudos Eves.....	468
Böhler pinza cortante para huesos.....	241	Bushe cucharilla cortante.....	256	cierra-tubos Hoffmann.....	624
Böhler pinza gubia.....	238			cierra-tubos Simplex.....	624
Boies elevador.....	277	C.....		cincel.....	259-261, 264, 265
bomba de aire.....	295	caja para esterilizacion.....	616, 618	cincel Alexander.....	259
bombilla de repuesto para laringoscopio.....	29, 30	cajas para instrumentos.....	617	cincel Brunetti.....	268
Bonaccolto pinza para estrabismo.....	385	calibrador decimal Iwanson.....	624	cincel Brünings-Lucas.....	260
Bonn pinza para sutura.....	386	calibre.....	26	cincel de esternon Lebsche.....	267
Bonney pinza de diseccion.....	88	calibre TOWNLEY.....	26	cincel Hibbs.....	265
Bose gancho para traqueotomia.....	477	Canfield bisturi para amigdalas.....	466	cincel nasal Cinelli.....	441
Bose separador traqueal.....	476	canula Air Injection.....	394	cincel nasal Cottle.....	440
Boucheron especulo auricular.....	399	canula capsular Jensen.....	394	cincel nasal Fomon.....	441
Bowman aguja de discision.....	374	canula de aspiracion rectal Buie.....	566	cincel nasal Freer.....	442/1
Bowman blefarostato.....	370	canula de aspiracion para mango de Zöllner y Wullstein.....	337/1	cincel nasal Hajek.....	442/1
Bowman cuchillo para discision.....	372	canula de inyeccion KLEINSASSER.....	36	cincel nasal Killian.....	442/1
Bowman sonda lacrimal.....	381	canula de irrigacion y aspiracion Bishop-Harmon.....	394/1	cincel nasal Killian-Claus.....	442/1
Boynton porta aguja.....	214	canula de puncion Lichtwitz.....	433	cincel nasal Niwert-Anderson.....	442
Boys-Allis pinza intestinal.....	538	canula de succion Baron.....	336	cincel nasal Rubin.....	440
Bozemann pinza porta esponja.....	138	canula de succion KLEINSASSER.....	36	cincel nasal Sheehan.....	441
Bozemann porta aguja.....	211	canula Hartmann.....	433	cincel nasal Silver.....	442



cincel nasal West .....	442/1	Cooley pinza para anastomosis.....	519, 520	cucharilla cortante Jacobson.....	257
cincel para cuerpos extraños Dix .....	374	Cooley pinza para cateter .....	510	cucharilla cortante Jansen .....	257
cincel para el tabique nasal Freer .....	439	Cooley pinza vascular .....	520	cucharilla cortante Lempert .....	256
cincel para extrirpacion Rollet.....	374	Cooley pinza vascular de uso multiple .....	518-520	cucharilla cortante Martini.....	257
cincel Parsch .....	259	Cooley pinza vascular pediatrica .....	522	cucharilla cortante REDA .....	256
cincel rompe-craneo .....	267	Cooley separador.....	148	cucharilla cortante Schede .....	251
cincel Smith-Petersen .....	261	Cooley separador costal .....	485, 487	cucharilla cortante Scoville .....	253
cincel Stille .....	260	COOLEY tubo de aspiracion .....	28	cucharilla cortante Spinal.....	253
cincel tamponador para huesos Passow .....	260	Cooley-Derra pinza para anastomosis.....	519	cucharilla cortante Spratt .....	251
Cinelli cincel nasal .....	441	Cooper aguja para ligadura.....	219	cucharilla cortante Volkmann.....	251, 257
Circumflex micro tijera .....	76	copas graduadas.....	620	cucharilla cortante Williger .....	255, 257
Citelli pinza sacabocado .....	430	Cordes punta de pinza .....	472	cucharilla para aborto Cuzzi .....	606
czialla para yesos Stille .....	229	Coronal Blow Lift separador .....	198	cucharilla para aborto Wallich .....	607
clamp atrauma Bulldog.....	100	Corwin-Hegar pinza para torcer hilo .....	319	cucharilla para cataratas Daviel.....	377
clamp atrauma Bulldog DeBakey .....	100, 103	Coryllos (Thorax) separador .....	166	cucharilla para cataratas Graefe .....	377
clamp atrauma Bulldog Glover .....	100, 103	Coryllos costotomo .....	480	cucharilla para cataratas Knapp .....	378
clamp Bulldog de Titanio .....	102	Cos pinza auricular micro.....	414	cucharilla para chalazion Axenfeld.....	377
clamp Bulldog DeBakey-Dietrich .....	101	costotomo .....	480, 481	cucharilla para chalazion Hebra .....	377
clamp Bulldog Dietrich .....	101	costotomo bethune .....	481	cucharilla para chalazion Meyhoefer.....	377
clamp umbilical Collin .....	605	costotomo Brunner .....	481	cucharilla para exenteracion Bunge.....	378
clamp umbilical Kane .....	605	costotomo Coryllos .....	480	cucharilla uterina Simon .....	594
CLAR lampara frontal .....	22	costotomo Giertz-Stille.....	481	cucharra para sangre .....	268, 621
Clark blefarostato .....	370	costotomo Gluck .....	480	cuchillo auricular Politzer .....	408
Claus aguja para sutura del paladar .....	466	costotomo Sauerbruch.....	481	cuchillo auricular Sexton .....	408
Claus-Eicken aguja para sutura del paladar .....	466	costotomo Sauerbruch-Frey .....	481	cuchillo corneal Eischsig.....	373
Clayman gancho .....	376	costotomo Stille .....	480	cuchillo corneal Gill .....	373
Cleveland pinza gubia .....	235	Cottle (Maltz) lima nasal .....	444	cuchillo corneal Sato .....	373
clip para esterilizacion Bunt .....	227, 624	Cottle cincel nasal .....	440	cuchillo corneal Took .....	373
clip para esterilizacion Mayo.....	227, 624	Cottle cuchillo rinoplastico.....	435	cuchillo de discision Berens.....	372
clips para aneurisma Yasargil .....	345-356	Cottle elevador para el tabique nasal .....	439	cuchillo de discision Jaeger .....	372
clips para vasos de Müller .....	365	Cottle especulo nasal .....	423	cuchillo de hoz REDA .....	435
Cloward pinza cortante para laminectomia .....	342	Cottle gancho para la piel.....	448	cuchillo interoseo .....	44
Cloward separador .....	178	Cottle Joseph elevador para el tabique nasal .....	439	cuchillo para amigdales Carpenter.....	465
Cloward separador para cuerpo vertebral.....	339	Cottle martillo .....	273	cuchillo para amputacion CATLIN.....	44
Cloward separador para tejido cervical .....	339	Cottle pinza para columnela .....	448	cuchillo para amputacion LANGENBECK.....	44
coagulacion bipolar .....	630-633	Cottle pinza para fijacion .....	410	cuchillo para amputacion LISTON .....	44
Coakley cureta para seno .....	449	Cottle retractor nasal .....	447, 447/1	cuchillo para amputacion REDA .....	44
Coakley trocar para seno maxilar .....	204	COTTLE tijera nasal.....	59	cuchillo para autopsia .....	48
COBB cureta.....	252	COTTLE tijera para cirugia .....	56	cuchillo para autopsia VIRCHOW .....	48
Cobb gubia.....	262	Cottle-Kazanjian pinza cortante para huesos .....	241	cuchillo para cataratas Deutschmann.....	371
Cobb periostotomo .....	280	Cottle-Neivert gancho para la piel .....	448	cuchillo para cataratas Graefe .....	371
Colclough pinza sacabocado para discos intervertebral.....	344/1	Coxeter cateter .....	555	cuchillo para cerebro VIRCHOW .....	48
Colibri (Barraquer) blefarostato .....	370	Crafoord pinza hemostatica .....	118	cuchillo para discision Wheeler .....	373
Colibri Barraquer tijera para oftalmologia .....	75	Crafoord tijera pulmonares .....	65/2	cuchillo para discision Bowman .....	372
Colibri pinza para iris.....	384	Crafoord-Sellors pinza hemostatica.....	119	cuchillo para discision Castroviejo.....	372
Coller-Crile pinza hemostatica .....	106	cranioclasto Braun .....	607	cuchillo para discision Graefe .....	372
Collier pelvimetro.....	605	cranioclasto Tarnier .....	607	cuchillo para discision Ziegler .....	373
Collier porta aguja .....	208	Crego elevador .....	282	cuchillo para falanges .....	44
Collin clamp umbilical .....	605	Crile gancho para nervio .....	328	cuchillo para goniotomia Barkan .....	373
COLLIN dinamómetro .....	25	Crile pinza hemostatica .....	107	cuchillo para goniotomia Scheie .....	373
Collin especulo vaginal .....	570	Crile porta aguja .....	213	cuchillo para iris Dean .....	372
Collin histerometro .....	586	Crile separador.....	140	cuchillo para iris Knapp .....	372
Collin Loktite separador abdominal .....	191	Crile-Murray porta aguja .....	209	cuchillo para iris Ziegler .....	372
COLLIN mango de bisturi .....	40	Crile-Rankin pinza hemostatica .....	107	cuchillo para organos .....	48
Collin martillo .....	270	Crile-Wood porta aguja .....	209	cuchillo para peristio .....	47
Collin pelvimetro .....	605	Critchett blefarostato .....	370	cuchillo para queratoplastica Barraquer .....	373
Collin pinza hemostatica .....	110	Crutchfield perforador inicial .....	327	cuchillo para queratoplastica Paufigue .....	373
Collin pinza para el utero .....	585	Crutchfield pinza de traccion craneal .....	327	cuchillo para reseccion .....	47
Collin pinza para quitar grafes .....	224	cubeta para placenta .....	621	cuchillo para reseccion LANGENBECK .....	47
Collin pinza para tejido .....	539	cubeta Petri .....	620	cuchillo para tabique nasal Ballenger .....	436
Collin pinza porta esponja.....	137	cubetas .....	619	cuchillo para tabique nasal Freer .....	434
Collin pinza tira-lengua.....	453	cuchara medicinal .....	268	cuchillo para vegetaciones adenoides Barnhill.....	450
Collin separador .....	139	cuchara para calculos biliares Desjardins.....	534	cuchillo para vegetaciones adenoides Beckmann.....	450
Collin separador abdominal .....	190	cuchara para calculos biliares Fergusson .....	533	cuchillo para vegetaciones adenoides St.Clair-Thomson .....	450
Collin-Duval pinza de diseccion.....	85	cuchara para calculos biliares Luer-Koerte.....	533	cuchillo para vendaje enyesado Esmarch .....	233
Collin-Hartmann separador.....	141	cuchara para calculos biliares Mayo .....	534	cuchillo para vendaje enyesado Hopkins .....	233
Colver pinza para coger amigdalas .....	467	cuchara para calculos biliares Moor .....	532	cuchillo para vendaje enyesado Reiner .....	233
compas marcador Castroviejo .....	380	cuchara y gancho Gross .....	409	cuchillo para vendajes enyesados Wigmore.....	229
Cone pinza sacabocado craneal.....	331	cucharilla cortante .....	251-257	cuchillo Plester .....	418
Connin-Amsler marcador .....	380	cucharilla cortante Bruns .....	251, 254	cuchillo rinoplastico Converse .....	435
Converse cuchillo rinoplastico .....	435	cucharilla cortante Bushe .....	256	cuchillo rinoplastico Cottle .....	435
Converse separador.....	448	cucharilla cortante Daubenspeck.....	255	cuchillo Rosen.....	418
Cooley dilatador de aorta.....	528	cucharilla cortante Halle.....	253	cuchillo Schuhknecht .....	418

cuchillo Tabb	418
cuchillo Wulstein	418
Culler espátula para iris	378
cureta Antrum	435
cureta aspiradora	600
cureta aspiradora para biopsia uterina Novak	587
cureta aspiradora para biopsia uterina Randall	587
cureta Buck	407
cureta Cobb	252
cureta Faulkner	449
cureta House	420
cureta para aborto Pestalozza	606
cureta para biopsia Heany	587
cureta para biopsia Kevorkian	587
cureta para biopsia Mod. Muenchen	587
cureta para cuerpos extraños Alvis	374
cureta para hipofisis	334
cureta para hipofisis RAY	334
cureta para lupus Fox	608
cureta para lupus Piffard	608
cureta para seno Coakley	449
curetas uterinas Blake	595
curetas uterinas Bumm	597
curetas uterinas Gourdet	599
curetas uterinas Recamier	597
curetas uterinas Schröder	595
curetas uterinas Sims	597
curetas uterinas Thomas	599
Cusco especulo vaginal	570
Cusco especulo vaginal	571
Cushing espátula cerebral	336, 369
Cushing gancho para nervio	328
Cushing pinza cortante para laminectomía	340
Cushing pinza de disección	83
Cushing separador	151, 152, 153
Cushing-Taylor pinza de disección	87
Cuzzi cucharilla para aborto	606
Czerny especulo rectal	559
Czerny pinza uterina	584
D	
Dandy gancho para nervio	328
Dandy pinza hemostática	109
Darling separador	178
Dartigues pinza para el útero	585
Dastoor pinza para estrabismo	386
Daubenspeck cucharilla cortante	255
Davidson (Scapula) separador	166
Davies cucharilla para cataratas	377
Davis aguja para cuerpos extraños	374
Davis elevador para duramadre	332
Davis espátula cerebral	337
Davis pinza para esterilización de jeringas	227
Davis-Boyle abre-boca	455
Davis-Meyer abre-boca	457
Day gancho auricular	409
De Boer separador costal	486
De Lee forceps obstétrico	602
De Martel-Wolfson pinza para anastomosis	546
De Martel-Wolfson pinza para cerrar clamps	546
De Martel-Wolfson porta-clamps	546
Dean cuchillo para iris	372
DEAN tijera para amígdalas	59
DEAVER separador	145, 146
DEAVER tijera de disección	52
DEAVER-GRIP separador	146
DeBaKey clamp atrauma Bulldog	100, 103
DeBaKey dilatador vascular	529
DeBaKey pinza para anastomosis	505, 515
DeBaKey pinza para aneurisma de la aorta	496, 497, 498
DeBaKey pinza para ligadura	493
DeBaKey pinza para ligadura	499, 500
DeBaKey pinza para vasos periféricos	494

DeBaKey pinza vascular de uso múltiple	495, 507, 508, 514, 515
DeBaKey pinza vascular pediátrica	516, 517
DeBaKey pinzas atraumáticas	98, 99
DeBaKey porta aguja	210
DeBaKey separador	189/1
DeBaKey tijera	60
DeBaKey tijera vascular	61
DeBaKey-Bahson pinza para aneurisma	506
DeBaKey-Dietrich clamp Bulldog	101
DeBaKey-Mosquito pinza hemostática	509
DeBaKey-Pean pinza hemostática atraumática	513
DeBaKey-Rankin pinza hemostática atraumática	512
DeBaKey-Satinsky pinza para oclusión tangencial	502
DeBaKey-Semb pinza para ligadura y la aorta	499
dedal	311
DEJERINE martillo de percusión	24
Delee especulo vaginal	574
DeMartel guía conductora	330
Demel aguja pasa-hilo	315
Demel tensor de cierra-hilo	315
Denhart abre-boca	454
Denis-Browne separador abdominal	185
depressor para epiglottis Reichert	471
depressor uterino Braun	586
depressor uterino Sims	586
DERF porta aguja	208
dermatoma HUMBY	50
dermatoma SCHINK	49
dermatoma SILVER	50
dermatoma WATSON	50
Derra pinza para anastomosis	515
D'Errico separador para la raíz de nervios	329/2
Deschamps aguja para ligadura	218
Desjardins cuchara para calculos biliares	534
Desjardins explorador para calculos biliares	532
Desjardins pinza hemostática	121
Desjardins pinza para calculos biliares	531
Desmarres pinza para chalazión	393
Desmarres separador	151
desoblitador de vena	202
destornillador Lane	323, 324
destornillador Williams	323
Deutschmann cuchillo para cataratas	371
Devilbiss pinza sacabocado craneal	332
diapason Hartmann	403
diapason REDA	403
diapason Lucae	404
diapason Rydel-Seiffert	404
diaposones	403, 404
Dieffenbach serra-fina	104
Dieter pinza auricular micro	414
Dietrich clamp Bulldog	101
Dietrich pinza para la aorta	510
DIETRICH tijera vascular	60
dilatador de aorta Cooley	528
dilatador de aorta Tubbs	528
dilatador lacrimal Castroviejo	381
dilatador lacrimal Wilder	381
dilatador lacrimal Ziegler	381
dilatador para conductos biliares Bakes	532
dilatador para el seno Ritter-Halle	433
dilatador para el seno Siebenmann	433/1
dilatador traqueal Laborde	476
dilatador traqueal Trousseau-Baby	476
dilatador uterino Goodell	581
dilatador uterino Hank	580
dilatador uterino Hegar	578, 579
dilatador uterino Pratt	580
dilatador uterino Sims	581
dilatador uterino Wylie	581
dilatador vascular DeBaKey	529
dinámometro COLLIN	25

Dingman elevador	463/3
Dingman periotomato	463
Dingmann abre-boca	456
Dingmann pinza para hueso	246
DIPLOMAT esfígmomanómetro	5
disecador corneal Green	374
disecador corneal Paton	373
disecador para el saco lacrimal Lang	378
disecador vascular Robb	530
disecador Watson-Cheyne	199
disector Fisch	420
disector Gorney	277
dispensador de cepillos	611
dispensador para brocas filiformes	310
Dittel buja dilatadora	554
Dix cincel para cuerpos extraños	374
Dix instrumento para cuerpo extraños (doble)	380
Doren pinza para biopsia	588
Doughty baja-lengua	458
Douglas bisturí para amígdalas	466
Douglas pinza depilatoria	395
Douglas trocar	204
Doyen especulo vaginal	574
Doyen estilete acanalado	199
Doyen periotomato	278
Doyen pinza de campo	133
Doyen pinza intestinal	540
Doyen pinza para polpos uterinos	585
Doyen separador	163
Doyen separador abdominal	189/1
Doyen tijera ginecológica	63
Doyen tirabuzón para fibroma	594
Doyen-Baby pinza intestinal	540
Doyen-Jansen (Molt) abre-boca	454
Doyen-Stille separador	167
Dubois tijera ginecológica	63
Duehrsen pinza de disección	84
Duval pinza porta-esponja	134
Duval pinza uterina	582
DUPLEX estetoscopio	23
Dupuy-Weiss aguja para sutura amígdalas	466
Durante pinza de disección	88
Duval pinza de disección	85
Duval pinza para tejido	539
E	
Echlin pinza gubia	240
ECO "T" y "C" estuche de diagnóstico	16
Eicken (Kilian) canula irrigación	433
electrocirugía	628, 629
elevador	281-291
elevador Adson	282
elevador Alderdyce	282
elevador auricular Zaufal	409
elevador auricular Zaufal-Jansen	409
elevador Bennett	283
elevador Blount	288
elevador Boies	277
elevador Bristow	290
elevador Buck-gramcko	285
elevador Chandler	282
elevador Crego	282
elevador Dingman	463/3
elevador Hohmann	284, 285
elevador Hohmann mini	286
elevador Key	282
elevador König	284
elevador Lane	290
elevador Lane Trethowan	290
elevador Lange-Hohmann	286
elevador Lempert	420
elevador Mc Donald	283
elevador Murphy-Lane	283

elevador Obwegeser.....	461	espátula cerebral Heifetz.....	369	estilete acanalado Doyen.....	199
elevador para amígdalas Henke.....	465	espátula cerebral Olivecrona.....	336	estilete hoja mirte.....	199
elevador para amígdalas Hurd.....	465	espátula Locke.....	612/1	estribo para extensión Böhler.....	312
elevador para amígdalas Lopez-Reinke.....	465	espátula para ciclodialisís Bangerter.....	379	estribo para extensión Kirschner.....	312
elevador para amígdalas Yankauer.....	465	espátula para ciclodialisís Castroviejo.....	379	estribo para extensión Kirschner U.S.....	312
elevador para cuerpos extraños Buck.....	412	espátula para ciclodialisís Elschmig.....	379	estuche de bolsillo y sutura.....	225
elevador para cuerpos extraños Quire.....	412	espátula para ciclodialisís Hirschman.....	379	estuche de diagnóstico ECO "T" y ECO "C".....	16
elevador para duramadre.....	332, 333	espátula para ciclodialisís Wheeler.....	379	estuche de diagnóstico UNI I.....	13
elevador para duramadre Davis.....	332	espátula para enucleación Wells.....	378	estuche de diagnóstico UNI II.....	14
elevador para duramadre Frazier.....	333	espátula para iris Culler.....	378	estuche de diagnóstico UNI III.....	15
elevador para duramadre Hoen.....	333	espátula para iris Wecker.....	378	estuche para autopsia.....	269
elevador para duramadre Horsley.....	333	espátula para la íntima Robb.....	530	estuche para sutura Standard.....	226
elevador para duramadre Milligan.....	332	espátula pulmonar Allison.....	489	estuche para sutura y agujas.....	225
elevador para duramadre Olivecrona.....	332	espátula vesical Kocher.....	552	estuche para traqueotomía.....	478
elevador para duramadre Penfield.....	333	espátula vesical Legueu.....	552	estuches de diagnóstico RI-MINI.....	17
elevador para duramadre Sachs.....	332	espátulas abdominales.....	143, 143/1	estuches para esterilizar agujas.....	615
elevador para duramadre Toennis.....	332	especula vaginal Vu-More.....	569	Eves cierranudos.....	468
elevador para duramadre Woodson.....	333	especulo auricular Boucheron.....	399	EXACTA-SPEZIAL esfigmomanómetro.....	8
elevador para el tabique nasal Ballenger.....	439	especulo auricular Bruenings.....	401	explorador para cálculos biliares Desjardins.....	532
elevador para el tabique nasal Cottle.....	439	especulo auricular Gruber.....	399	explorador para cálculos biliares Moynihan.....	532
elevador para el tabique nasal Cottle Joseph.....	439	especulo auricular Hartmann.....	399	extractor Küntscher.....	322
elevador para el tabique nasal Freer.....	437	especulo auricular Politzer.....	399	extractor/impactor para clavos.....	321, 322
elevador para el tabique nasal Hajek-Ballenger.....	439	especulo auricular Richnau-Holmgren.....	400	F	
elevador para el tabique nasal Halle.....	437	especulo auricular Siegle.....	402	face lift tijera Freeman.....	73
elevador para el tabique nasal Howarth.....	438	especulo auricular Toynbee.....	399	face lift tijera Gorney.....	73
elevador para el tabique nasal Joseph.....	437	especulo endocervical Kogan.....	577	face lift tijera kaye.....	73
elevador para el tabique nasal Killian.....	438, 439	especulo Friedmann.....	577	face lift tijera Peck Joseph.....	73
elevador para el tabique nasal McKenty.....	437, 438	especulo nasal Cottle.....	423	Face lift tijera Rees.....	73
elevador para el tabique nasal Pennington.....	438	especulo nasal Hartmann.....	422	Fansler protoscopio.....	564
elevador para el tabique nasal Pierce.....	438	especulo nasal Killian.....	423	Farabeuf periostotomo.....	274
elevador para el tabique nasal Roger.....	437	especulo nasal Mod. Vienna.....	423	Farabeuf pinza para hueso.....	243
elevador SAYRE.....	281	especulo nasal REDA.....	423	Farabeuf separador.....	139
elevador Verbrugge-Müller.....	286/2	especulo nasal Thudichum.....	421	Farabeuf-Collin periostotomo.....	274
elevador Watson-Cheyne.....	283	especulo nasal Tieck-Halle.....	423	Farabeuf-Lambotte pinza para hueso.....	243
Elliot forceps obstétrico.....	602	especulo nasal Voltolini.....	421	Farrell porta-algodon.....	203
Ellis gubia para cuerpos extraños.....	374	especulo rectal Alan-Parks.....	561	Faulkner cureta.....	449
Elschnig cuchillo corneal.....	373	especulo rectal Barr.....	559	Faure pinza para biopsia.....	588
Elschnig espátula para ciclodialisís.....	379	especulo rectal Bodenhammer.....	559	Faure pinza para peritoneo.....	123
Elschnig pinza capsular.....	391	especulo rectal Czerny.....	559	Favaloro tijera vascular.....	61
Elschnig pinza para fijación.....	389	especulo rectal Hill-Ferguson.....	560	Fehland pinza intestinal.....	542
Emmet gancho para fistulas.....	594	especulo rectal Mathieu.....	560	Feilchenfeld pinza para espaldas.....	91
Engel sierra para vendajes enyesados.....	229	especulo rectal Pratt.....	559	Feldheim pinza para huesos.....	249
ensordecedor Barany.....	405	especulo rectal Sawyer.....	560	Ferguson cuchara para cálculos biliares.....	533
ENUCLEATION tijera.....	58	especulo rectal Schulze-Bergmann.....	560	Ferguson pinza hemostática.....	109
Epker osteotomo.....	464/2	especulo rectal Sims.....	559	Ferguson pinza para hueso.....	243
Eppendorfer pinza para biopsia.....	590	especulo vaginal.....	569-577	Ferguson tijera para intestino.....	66
escariador.....	304	especulo vaginal Auvard.....	576	Ferguson tubo de aspiración.....	337
escariador Perthes.....	304	especulo vaginal Breisky.....	577	Ferrera separador para cirugía plástica.....	197
esclerotomo Guyton-Lundsgaard.....	373	especulo vaginal Collin.....	570	Ferris-Smith pinza cortante para laminectomía.....	343
esclerotomo Lundsgaard.....	373	especulo vaginal Cosco.....	570	Ferris-Smith pinza de disección.....	85
escofina nasal Miller.....	444	especulo vaginal Cosco.....	571	Ferris-Smith-Kerrison pinza sacabocado para discos intervertebral.....	344, 344/2
escofina nasal Peet.....	446	especulo vaginal Delee.....	574	Finocchioetto pinza bronquial.....	490
escofina nasal Wiener.....	443	especulo vaginal Doyen.....	574	Finocchioetto porta aguja.....	211
escupidora.....	621	especulo vaginal Grave.....	570	Finocchioetto separador costal.....	482, 484
esfigmomanómetro BABYPHON.....	10	especulo vaginal Jackson.....	573	Finocchioetto-Burford separador costal.....	483
esfigmomanómetro EXACTA-SPEZIAL.....	8	especulo vaginal Kallmorgen.....	573	Finsen separador.....	168
esfigmomanómetro MINIMUS II.....	11	especulo vaginal Kristeller.....	572	Fisch disector.....	420
esfigmomanómetro MINIMUS III.....	12	especulo vaginal Landau.....	577	Fisch gancho para duramadre.....	335
esfigmomanómetro NOVA.....	7	especulo vaginal O'Sullivan-O'Connor.....	576	Fischer pinza para iris.....	384
esfigmomanómetro NOVA-PRESAMETER.....	6	especulo vaginal Pederson.....	570	Fish sonda.....	199
esfigmomanómetro PRECISA.....	9	especulo vaginal Scherbak.....	575	Fisher bisturi para amígdalas.....	466
esfigmomanómetro, DIPLOMAT.....	5	especulo vaginal Semm.....	571	Foerster pinza para iris.....	383
Esmarch cuchillo para vendaje enyesado.....	233	especulo vaginal Sims.....	573	Foerster porta esponjas.....	136
Esmarch tijera para vendaje.....	69/2	especulo vaginal Trelat.....	571	Fomon cincel nasal.....	441
Esmarch vendaje de compresión.....	296	espejo frontal ZIEGLER.....	21	Fomon gancho nasal.....	447/1
espátula.....	203	espejo laringeo.....	473	Fomon lima nasal.....	444, 445
espátula abdominal Haberer.....	143/1	espejo laringeo Michel.....	423	Fomon periostotomo.....	277
espátula abdominal Kader.....	143/1	estetoscopio ANESTOPHON.....	23	FOMON tijera nasal.....	58
espátula abdominal Kümmel.....	144	estetoscopio DUPLEX.....	23	Fomon tijera para rinoplastia.....	65/1
espátula abdominal Ribbon.....	143	estetoscopio PINARD.....	23	forceps obstétrico Barton.....	603
espátula cerebral Cushing.....	336, 369	estilete abotonado.....	199	forceps obstétrico Boerma.....	604
espátula cerebral Davis.....	337	estilete acanalado abotonado.....	199		

forceps obstetrico De Lee.....	602
forceps obstetrico Elliot.....	602
forceps obstetrico Kielland.....	602
forceps obstetrico Kielland-Luikart.....	603
forceps obstetrico Luikart.....	603
forceps obstetrico McLean.....	603
forceps obstetrico McLean-Tucker.....	603
forceps obstetrico McLean-Tucker-Luikart.....	603
forceps obstetrico Naegele.....	602
forceps obstetrico Piper.....	604
forceps obstetrico Simpson.....	602
forceps obstetrico Simpson-Braun.....	602
forceps obstetrico Simpson-Luikart.....	603
forceps obstetrico Tarnier.....	604
forceps obstetrico Wrigley.....	602
FOREGGER juego de laringoscopia.....	31
FOREGGER laringoscopia.....	29
Fox cureta para lupus.....	608
Fraenkel pinza para laringe.....	471
Fraenkel punta de pinza.....	472
Francis aguja para cuerpos extraños.....	374
Franklin-Silvermann aguja para biopsia.....	206
Frazier elevador para duramadre.....	333
Frazier ganchito.....	149
Frazier separador abdominal.....	181
Frazier/Fergusson tubo de aspiracion.....	337
Freeman separador.....	198
Freeman tijera face lift.....	73
Freer cincel nasal.....	442/1
Freer cincel para el tabique nasal.....	439
Freer cuchillo para tabique nasal.....	434
Freer elevador para el tabique nasal.....	437
Freer gancho para la piel.....	448
FRENZEL anteojos para nistagmo.....	20
Frenzel baja-lengua.....	451
Friedmann especulo.....	577
Friedmann mini pinza gubia.....	234
Friedmann pinza gubia.....	234
Fritsch separador.....	163
Frykholm pinza gubia.....	240
Fuchs pinza capsular.....	391
Fuchsig pinza hemostatica.....	113
<b>G</b>	
Gallaher lima para seno.....	446
ganchito Frazier.....	149
ganchito Graefe.....	149
ganchito Guthrie.....	149
ganchito Joseph.....	149
ganchito Kleinert-Kutz.....	149
ganchito Lahey.....	149
ganchito nasal Fomon.....	447/1
gancho abotonado Lucae.....	409
gancho abotonado Wagener.....	409
gancho auricular Day.....	409
gancho Barbara.....	419
gancho Clayman.....	376
gancho cutaneo Kliner.....	608
gancho de decapitacion Braun.....	607
gancho de menton Obwegeser.....	461
gancho extractor.....	322
gancho Gass.....	376
gancho Kirschner.....	313
gancho Klapp.....	150
gancho Knapp.....	375
gancho McGee.....	419
gancho muscular.....	267
gancho muscular Green.....	375
gancho obstetrico Smellie.....	605
gancho para cristalino Stevens.....	375
gancho para duramadre.....	335
gancho para dura-madre Adson.....	329
gancho para duramadre Fisch.....	335

gancho para estrabismo Graefe.....	375
gancho para estrabismo Jameson.....	375
gancho para extraccion Arruga.....	375
gancho para fistulas Emmet.....	594
gancho para galea Yasargil.....	330
gancho para iris O'Conner.....	375
gancho para iris Wiener.....	375
gancho para la piel Cottle.....	448
gancho para la piel Cottle-Neivert.....	448
gancho para la piel Freer.....	448
gancho para la piel Gillies.....	448
gancho para las alas de la nariz Lange.....	448
gancho para nervio Crile.....	328
gancho para nervio Cushing.....	328
gancho para nervio Dandy.....	328
gancho para nervio Graham.....	329
gancho para nervio Sachs.....	329
gancho para nervio Smithwick.....	329
gancho para nervios Kraysenbühl.....	336
gancho para sacar el inserto I.U.D.....	593
gancho para traqueotomia Bose.....	477
gancho para traqueotomia Itersen.....	477
gancho para traqueotomia Jackson.....	476
gancho para traqueotomia News.....	477
gancho REDA.....	150
gancho Rollet.....	375
gancho Rosen.....	419
gancho Shambaugh.....	419
gancho Sinskey.....	376
ganchos.....	419
garrote de madera Maunder.....	459
Gass gancho.....	376
Gauss pinza para pericraneio.....	605
Gelpi separador perineal.....	189/1, 189/2
Gemini pinza hemostatica.....	115
Gerald pinza de diseccion.....	86, 87
Gerster barra de traccion.....	250
Gerzog martillo.....	270
Giertz-Stille costotomo.....	481
Gigli mango para sierra hilo.....	332
Gill cuchillo corneal.....	373
Gill pinza para iris.....	384
Gill-Arruga pinza capsular.....	390
Gill-Hess pinza para iris.....	384
Gillies gancho para la piel.....	448
Gillies pinza de diseccion.....	86
Gillies porta aguja.....	212
Git-Vernet separador.....	152
Glover clamp trauma Bulldog.....	100, 103
Glover pinza para uso multiple.....	515
Gluck costotomo.....	480
Goelet separador.....	141
Goldman-Fox tijera para encias.....	67
Gomel micro tijera.....	80
Gomel pinza para microcirugia.....	96
goniometro MOELTGEN.....	25
goniometro para dedos.....	25
GOOD tijera para amigdalas.....	59
Goodell dilatador uterino.....	581
Gorney disector.....	277
Gorney tijera face lift.....	73
Gosset separador abdominal.....	181
Gourdet curetas uterinas.....	599
Gradle pinza depilatoria.....	395
GRADLE tijera para oftalmologia.....	57
Graefe blefarostato.....	370
Graefe cucharilla para cataratas.....	377
Graefe cuchillo para cataratas.....	371
Graefe cuchillo para discision.....	372
Graefe ganchito.....	149
Graefe gancho para estrabismo.....	375
Graefe pinza de diseccion.....	83
Graefe pinza para fijacion.....	389

Graefe pinza para iris.....	382
Graefe quistotomo.....	375
GRAEFFE tijera para cirugia.....	56
Graham gancho para nervio.....	329
Graig pinza para tabique nasal.....	426
grapa para cuero cabelludo Raney.....	327
grapas.....	326
Grave especulo vaginal.....	570
Gray pinza hemostatica.....	121
Green disecador corneal.....	374
Green gancho muscular.....	375
Green pinza para fijacion.....	390
Green separador.....	160
Green-Armytage pinza para uterus.....	605
Gregory pinza atraumatica.....	517
Greven pinza auricular micro.....	414
Grip alicata.....	316
Gross cuchara y gancho.....	409
Gross-Maier pinza porta-esponja.....	134
Gruber especulo auricular.....	399
gubia.....	259-265
gubia Alexander.....	259
gubia Brünings-Lucas.....	260
gubia Cobb.....	262
gubia Hibbs.....	265
gubia Lexer.....	263
gubia Lexer Mini.....	263
gubia para cuerpos extraños Ellis.....	374
gubia para cuerpos extraños Walton.....	374
gubia Partsch.....	259
gubia Smith-Petersen.....	261
gubia Stille.....	260
gubia Zielke.....	264
guia-conductora DeMartel.....	330
guia-conductora para clavos medulares.....	321
Guilen legra de succion.....	433/1
Gulthrie ganchito.....	149
Guyon buja dilatadora.....	554
Guyon mandril para cateter.....	554
Guyon pinza hemostatica.....	122
Guyton-Lundsgaard esclerotomo.....	373
<b>H</b>	
Haberer espátula abdominal.....	143/1
Haglund-Stille separador para yesos.....	232
Haight separador costal.....	487
Hajek cincel nasal.....	442/1
Hajek martillo.....	273
Hajek-Ballenger elevador para el tabique nasal.....	439
Hajek-Kofler pinza cortante.....	429
Hajek-Kofler pinza sacabocado.....	431
Halle cucharilla cortante.....	253
Halle elevador para el tabique nasal.....	437
Halsey porta aguja.....	208
Halsted-Mosquito pinza hemostatica.....	105
Hank dilatador uterino.....	580
Hargis separador para el borde anterior.....	463
Hargis separador para el cuerpo mandibular.....	463/6
Harken pinza auricular.....	503
Harms sonda.....	381
Harrington pinza bronquial.....	490
Harrington separador.....	147
Harrington-Pemberton separador.....	147
Hartmann baja-lengua.....	452
Hartmann canula.....	433
Hartmann cateter auricular.....	408
Hartmann diapason.....	403
Hartmann especulo auricular.....	399
Hartmann especulo nasal.....	422
Hartmann pinza auricular.....	411
Hartmann pinza hemostatica.....	104
Hartmann pinza nasal.....	424, 427
Hartmann pinza para polipos.....	412

Hartmann-Halle especulo nasal.....	421	Huber mango universal.....	472	Joseph sierra nasal.....	446
Hartmann-Hoffmann pinza para polipos.....	412	Hudson perforador de mano.....	299	JOSEPH tijera para cirugía.....	54
Hartmann-Wulstein pinza para polipos.....	412	Hulka pinza uterina.....	583	Judd-Allis pinza intestinal.....	538
Haugh pinza auricular micro.....	414	HUMBY dermatomo.....	50	Judd-Masson separador vesical.....	552
Hayes pinza para anastomosis del recto.....	545	Hunter pinza para espinas.....	91	juego de laringoscopio FOREGGER.....	31
Heaney pinza para histerectomia.....	126	Hurd elevador para amigdales.....	465	juego de laringoscopio McIntOSH.....	31
Heaney porta aguja.....	210	I.....		juego de manicura para enfermeras.....	609
Heaney separador.....	164	I.U.D. gancho para sacar el insierito.....	593	juego para varices NABATOFF.....	201
Heany cureta para biopsia.....	587	iman ocular REDA.....	395	Juers pinza auricular micro.....	414
Heany-Ballentine pinza para histerectomia.....	127	impactor final Kuentscher.....	321	Jurasz pinza para polipos laringeos.....	471
Heath martillo.....	273	impactor/extractor para clavos.....	321, 322	K.....	
Heath tijera para ligadura.....	66	Inge separador para cuerpo vertebral.....	339	Kabierske lanzapolo.....	405
Hebra cucharilla para chalazion.....	377	Instru Care aceite para instrumentos.....	634	Kader espátula abdominal.....	143/1
Hegar dilatador uterino.....	578, 579	instrumento para circuncision.....	556	Kallmorgen especulo vaginal.....	573
Hegebarth pinza para aplicar agrafes.....	224	instrumento para circuncision Mogen.....	556	Kalt pinza capsular.....	391
Heifetz espátula cerebral.....	369	instrumento para cuerpo extraños (doble) Dix.....	380	Kalt porta aguja.....	214
Heiming pinza para calculos renales.....	536	instrumento para cuerpos extraños La Force.....	374	Kalt-Arruga porta aguja.....	214
Heiss pinza hemostatica.....	112	instrumento para el fragmento de la uña.....	612/1	Kane clamp umbilical.....	605
Heister abre-boca.....	454	instrumento para varices Varady.....	202	Kantrowitz pinza hemostatica.....	119/1
hemostatico.....	258, 259	instrumento para vendaje enyesado REDA.....	232	Kaye tijera face lift.....	73
hemostatico Caspar.....	258	instrumentos para manicura.....	612, 612/1	Kelly Grip separador.....	142
Henke elevador para amigdales.....	456	instrumentos para medir.....	594	Kelly pinza hemostatica.....	106
Henley separador.....	170	instrumentos para traqueotomia.....	475	Kelly pinza para polipos uterinos.....	585
Hennig separador para yesos.....	232	Iowa pinza uterina.....	584	Kelly protoscopio.....	562, 563
Hepp-Scheidel micro tijera.....	78	IRIS tijera para cirugía.....	54	Kelly separador.....	142, 164
Herrick pinza para pediculo.....	123	Iris tijera supercut.....	72	Kelly tijera vascular.....	61
Hess pinza capsular.....	391	Israel separador.....	162	Kelly-Rankin pinza hemostatica.....	106
Hess pinza para iris.....	384	Iterson gancho para traqueotomia.....	477	Kern pinza para hueso.....	244
Hess separador para la raiz de nervios.....	329/1	Ives-Fansleroscopio.....	562	Kerrison pinza cortante.....	428
Heymann pinza nasal.....	425	Ivanson calibrador decimal.....	624	Kevorkian cureta para biopsia.....	587
HEYMANN tijera nasal.....	58	J.....		Kevorkian pinza para biopsia.....	589, 591
Heymann-Knight pinza nasal.....	425	Jackson especulo vaginal.....	573	Kevorkian-Pacific pinza para biopsia.....	592
Heywood-Smith pinza hemorroidal.....	567	Jackson gancho para traqueotomia.....	476	Key elevador.....	282
Hibbs cincel.....	265	JACKSON laringoscopio.....	37	Keyes trepano.....	608
Hibbs gubia.....	265	Jackson pinza de agarre para tendones.....	292	Kielland forceps obstetrico.....	602
Hibbs osteotomo.....	265	JACKSON portador de luz.....	37	Kielland-Luikart forceps obstetrico.....	603
Hibbs separador.....	164	Jackson pinza para taponos.....	471	Killian (Eicken) canula irrigacion.....	433
Hill-Ferguson especulo rectal.....	560	JACKSON separador de luz.....	37	Killian canula.....	433/1
hilos para huesos.....	314	Jackson separador traqueal.....	476	Killian cincel nasal.....	442/1
Hirschman espátula para ciclodialisis.....	379	Jackson-Burrows separador.....	189/2	Killian elevador para el tabique nasal.....	438, 439
Hirschmann anoscopio.....	562	Jacobs pinza uterina.....	583	Killian especulo nasal.....	423
histerometro Collin.....	586	Jacobsen porta aguja.....	215	Killian tijera para septo.....	471
histerometro Martin.....	586	Jacobson cucharilla cortante.....	257	Killian tijera para septo.....	471
histerometro Sims.....	586	Jacobson sonda abotonada.....	335	Killian-Claus cincel nasal.....	442/1
histerometro Valleix.....	586	Jaeger cuchillo de discision.....	372	Kilner gancho cutaneo.....	608
Hoen elevador para duramadre.....	333	Jaeger cuchillo de discision.....	372	Kilner porta aguja.....	212
Hoessel porta aguja.....	213	Jaeger placa para parpado.....	371	Kilner retractor nasal.....	447/1
Hofer separador para pilar.....	465	Jameson gancho para estrabismo.....	375	KILNER tijera para cirugía.....	54
Hoffmann cierra-tubos.....	624	Jameson pinza para estrabismo.....	385	Kilner/Ragnell tijera supercut.....	72
Hohmann elevador.....	284, 285	Jansen cucharilla cortante.....	257	Kilner-Doughty abre-boca.....	456
Hohmann mini elevador.....	286	Jansen pinza gubia.....	237	Kirby-Arthur pinza para fijacion.....	385
hoja de repuesto para dermatomo.....	49	Jansen pinza nasal.....	424	Kirk martillo.....	270
hoja de repuesto para dermatomo.....	50	Jansen separador.....	168	Kirschner alambre.....	306, 307
hojas de afeitar.....	45	Jansen-Gruenwald pinza nasal.....	424	Kirschner estribo para extension.....	312
hojas de bisturi, esteri.....	42	Jarcho pinza uterina.....	583	Kirschner gancho.....	313
hojas de bisturi, esteri, desechables.....	43	Javid pinza para shunt carotido.....	511	Kirschner perforador de mano.....	299
hojas de cincel intercambiables.....	266	Jennings abre-boca.....	454	Kirschner separador abdominal.....	185, 187, 187/1
hojas de osteotomo intercambiables.....	266	Jensen canula capsular.....	394	Kirschner sonda conductora.....	221
Hoke osteotomo.....	265	jeringa.....	406, 407	Kirschner soporte de esterilizacion para alambres.....	305
HOLINGER laringoscopio.....	37	jeringa auricular Reiner.....	406	Kirschner U.S. estribo para extension.....	312
HOLINGER portador de luz.....	37	jeringa para amigdalas.....	470	Klapp gancho.....	150
Holsher separador para la raiz de nervios.....	329/1	Jobson-Horne porta-algodon.....	203	Kleinert-Kutz gancho.....	149
Holth pinza para capsuloiridectom.....	380	Johns-Hopkins pinza hemostatica.....	120	Kleinert-Kutz pinza de agarre para tendones.....	294
Holzbach pinza para histerectomia.....	126	Johns-Hopkins serra-fina.....	104	Kleinert-Kutz pinza gubia.....	237
Holzheimer separador.....	168	Jones pinza de campo.....	132	KLEINSASSER anillo.....	36
Hopkins cuchillo para vendaje enyesado.....	233	Jones-Clip pinza de campo.....	132	KLEINSASSER articulacion.....	36
horquilla fijadora Burch.....	373	Jonson porta aguja.....	211	KLEINSASSER canula de inyeccion.....	36
Horsley elevador para duramadre.....	333	JORGENSEN tijera de diseccion.....	53	KLEINSASSER canula de succion.....	36
Hösel separador.....	167	Joseph bisturi nasal.....	434, 435	KLEINSASSER laringoscopio operativo.....	35
House cureta.....	420	Joseph elevador para el tabique nasal.....	437	KLEINSASSER portadore de luz fria.....	36
House sonda para medir.....	420	Joseph gancho.....	149	KLEINSASSER soporte pectoral.....	36
House tubo de aspiracion.....	337/2	Joseph lima para hueso.....	443	Kleinschmidt pinza para apendice.....	544
Howarth elevador para el tabique nasal.....	438	Joseph periostotomo.....	277	Klinikum Berlin pinza cierra-tubo.....	129

Klinkenbergh-Loth tijera vasija.....	65/2	Lang diseccador para el saco lacrimal.....	378	Littauer pinza depilatoria.....	395
Knapp cucharilla para cataratas.....	378	Lange gancho para las alas de la nariz.....	448	Littauer pinza para polipos.....	425
Knapp cuchillo para iris.....	372	Lange punta de pinza.....	472	Littauer tijera para ligadura.....	66
Knapp gancho.....	375	Lange-Hohmann elevador.....	286	Little separador.....	157
KNAPP tijera para cirugia.....	55	Langenbeck asa.....	409	LITTLEL tijera para cirugia.....	55
Knapp-Luer pinza para tracoma.....	393	LANGENBECK cuchillo para amputacion.....	44	Littlewood pinza intestinal.....	538
Knight pinza nasal.....	425	LANGENBECK cuchillo para reseccion.....	47	llave de tuerca.....	313
Knowles tijera para vendaje.....	70	Langenbeck periostotomo.....	275	Locke espátula.....	612/1
Kocher espátula vesical.....	552	Langenbeck pinza para hueso.....	243	Lockhart-Mummery pinza para fistula.....	200
Kocher pinza hemostatica.....	108	Langenbeck porta aguja.....	213	Locklin tijera para encias.....	69
Kocher pinza intestinal.....	540	Langenbeck separador.....	158, 159	Lockwood-Allis pinza intestinal.....	538
Kocher separador.....	155	Langenbeck sierra para amputacion.....	296	London-College pinza dental.....	93
Kocher separador.....	159, 160, 163	Langenbeck-Green separador.....	153	Lopez-Reinke elevador para amigdales.....	465
Kocher sonda para bocio.....	479	lanzapolo Kabierske.....	405	Lorenz tijera para vendaje.....	70
Kocher-Langenbeck separador.....	159	laringoscopia FOREGGER.....	29	Lorna pinza para campo.....	133
Koenig sonda conductora.....	221	laringoscopia HOLINGER.....	37	Loute tensor de tierra-hilo.....	315
Koerte separador.....	162	laringoscopia JACKSON.....	37	Love separador para la raiz de nervios.....	329/2, 330
Kogan espejulo endocervical.....	577	laringoscopia McINTOSH.....	29	Love separador para uvula.....	465
König elevador.....	284	laringoscopia MILLER.....	30	Love-Gruenwald pinza cortante para laminectomia.....	340
König periostotomo.....	276	laringoscopia operativo KLEINSASSER.....	35	Lovelace pinza hemostatica.....	109
König separador.....	153	Larsen pinza para tendones.....	292	Lovelace pinza para coger el pulmon.....	490
Koos micro cuchillo.....	335	Lawrence pinza hemostatica.....	119	Lower pinza hemostatica.....	120
Körte separador.....	143/1	Lebsche cincel de esternon.....	267	Lowman pinza para huesos.....	249
Krause cierra-nudo auricular.....	411	Lees pinza bronquial.....	504	Lowman-Hoglund pinza para huesos.....	249
Krause polipotomo.....	433/2	legra corneal Kuhnt.....	373	Lubet-Barbon pinza nasal.....	424
Krause punta de pinza.....	472	legra de succion Guilen.....	433/1	Luc pinza nasal.....	426
Krause-Voss polipotomo.....	433/2	Legueu espátula vesical.....	552	Lucae aguja para paracentesis.....	408
Krayenbühl gancho para nervios.....	336	Legueu separador vesical.....	553	Lucae diaposon.....	404
Kristeller espejulo vaginal.....	572	Leksell (Stille) pinza gubia.....	240	Lucae gancho abotonado.....	409
Kroenig baja-lengua.....	451	Leland-Jones pinza para vasos perifericos.....	494	Lucae martillo.....	271
Kronecker aguja para ligadura.....	219	Lempert cucharilla cortante.....	256	Lucae pinza auricular.....	410
Kuentscher impactor final.....	321	Lempert elevador.....	420	Luer canula para traqueotomia.....	479
Kuglen manipulador.....	376	Lempert pinza gubia.....	237	Luer pinza gubia.....	236
Kühnt legra corneal.....	373	Lerche pinza de diseccion.....	83	Luer separador.....	140
Kümmel espátula abdominal.....	144	Lerliche pinza hemostatica.....	111	Luer-Koerte cuchara para calculos biliares.....	533
Kümmel separador abdominal.....	143/2	Lerliche separador intestinal.....	143/2	Luikart forceps obstetrico.....	603
Küntscher extractor.....	322	Lester pinza para fijacion.....	389	Luikart-Bill tractor.....	604
Küntscher perforador para femur.....	321	Levinson aguja para cuerpos extraños.....	374	Lundsgaard esclerotomo.....	373
Küntscher perforador para la cavidad medular.....	321	Lewin pinza para hueso.....	246	Luniatschek tamponeador.....	465
L.....		Lewis (Joseph) lima nasal.....	443	M.....	
L&M separador intra oral.....	463/4	LEXER BABY tijera de diseccion.....	53	MAGILL pinza para introducir cateter.....	28
La Force instrumento para cuerpos extraños.....	374	Lexer gubia.....	263	malla de alambre.....	311
La Grange tijera para encias.....	69	Lexer Mini gubia.....	263	Maltz lima nasal.....	443, 444
La Grange tijera supercut.....	72	Lexer Mini osteotomo.....	263	mandril.....	300
Laborde dilatador traqueal.....	476	Lexer osteotomo.....	263	mandril para cateter Guyon.....	554
Lacrimal canula.....	394	LEXER tijera de diseccion.....	53	mango bisturi MINI.....	41
LaForce adenotomo.....	450	Leyla separador de sistema.....	368-368/4	mango bisturies.....	38-41
Lahey ganchito.....	149	lezna Obwegeser.....	463, 463/3	mango con iluminacion para proctoscopia Morgan.....	565
Lahey pinza para agarrar el bocio.....	479	Lichtenberg porta aguja.....	213	mango de aspiracion Wulstein.....	338
LAHEY pinzas hemostáticas.....	119/2, 120	Lichtwitz canula de puncion.....	433	mango de bisturi COLLIN.....	40
Lahey separador.....	157	Lichtwitz trocar para seno maxilar.....	204	mango de pila para laringoscopia.....	32, 33, 34
Lambert pinza para chalazion.....	393	Liebermann blearostato.....	371	mango para cincel/gubia.....	266
Lambert-Kay pinza para anastomosis.....	505	ligador para hemorroides.....	568	mango para espejo laringeo.....	473
Lambert-Lowman pinza para huesos.....	249	ligador para hemorroides McGivney.....	568	mango para sierra hilo Gigli.....	332
Lambotte osteotomo.....	261	ligador para hemorroides Rudd.....	568	mango universal Huber.....	472
Lambotte periostotomo.....	274	lima nasal Aufrecht.....	443	mangos de acople rapido.....	301
Lambotte pinza para hueso.....	244	lima nasal Cottle (Maltz).....	444	manguito de cierre Stone-Watt.....	545
lampara frontal CLAR.....	22	lima nasal Fomon.....	444, 445	manipulador Kuglen.....	376
lampara halogena.....	29	lima nasal Lewis (Joseph).....	443	manometro.....	295
Lancaster blearostato.....	371	lima nasal Maltz.....	443, 444	manopla de plomo.....	250
Landau espejulo vaginal.....	577	lima para hueso Joseph.....	443	marcador Connin-Amsler.....	380
Landolt pinza para tumores.....	341	lima para huesos.....	294	Marquardt pinza gubia.....	239
Lane destornillador.....	323, 324	lima para huesos.....	612/1	Marschik pinza para amigdales.....	468
Lane elevador.....	290	lima para huesos Putti.....	294	Martel pinza hemostatica.....	110
Lane palanca para doblar placas.....	325	lima para seno Gallaher.....	446	martillo.....	270, 271, 272, 273
Lane pinza de campo.....	133	lima para uñas.....	610	martillo Bergmann.....	272
Lane pinza de diseccion.....	84	Lister (Sinus) pinza porta esponja.....	137	martillo Collin.....	270
Lane pinza estomacal.....	547	Lister tijera para vendaje.....	69/1	martillo Cottle.....	273
Lane pinza para hueso.....	244	Lister tijera supercut.....	72	martillo de percusion BABINSKY.....	24
Lane pinza para sostener placas.....	325	Lister-Burch blearostato.....	370	martillo de percusion BERLINER.....	24
Lane pinza para sostener tornillos.....	325	LISTON cuchillo para amputacion.....	44	martillo de percusion BUCK.....	24
Lane Trethowan elevador.....	290	Liston pinza cortante para huesos.....	241	martillo de percusion TAYLOR.....	24
		Littauer pinza auricular.....	411		

martillo de percusion TROEMNER.....	24	Melling-Axenfeld blefarostato.....	370	Moynihan pinza de campo.....	133
martillo Gerzog.....	270	Menghini aguja para biopsia.....	206	Moynihan pinza hemostatica.....	120
martillo Hajek.....	273	meniscotomo Neff.....	292	Mueller blearostato.....	371
martillo Heath.....	273	meniscotomo Smillie.....	292	Muenchen Mod. cuerta para biopsia.....	587
martillo Kirk.....	270	Mercedes separador toracico.....	489	Müller aproximador.....	364
martillo Lucae.....	271	Meriam pinza dental.....	93	Müller clips para vasos.....	365
martillo Mead.....	271	Metzenbaum porta aguja.....	211	Murdock blefarostato.....	370
martillo Ombredanne.....	273	METZENBAUM tijera de diseccion.....	53/1	Murphy separador.....	156
martillo Partsch.....	271	METZENBAUM tijera para cirugía.....	54	Murphy-Lane elevador.....	283
martillo Quising.....	271	Metzenbaum tijera supercut.....	71	Museum pinza uterina.....	583
martillo Williger.....	271	Meyering separador.....	157, 177, 180	Myles pinza nasal.....	427
Martin histerometro.....	586	Meyhoefer cucharilla para chalazion.....	377	N	
Martin pelvimetro.....	605	Michel agrafe.....	224	NABATOFF juego para varices.....	201
Martin pinza para cartilago.....	246	Michel espejo laringeo.....	423	Naegele forceps obstetrico.....	602
Martin separador.....	175/1	Michel pinza para aplicar agrafes.....	224	Nager aguja para sutura del paladar.....	466
Martin-Cartilage tijera.....	65/1	Michel pinza para aplicar y quitar agrafes.....	224	Nager separador para paladar.....	465
Martini cucharilla cortante.....	257	micro cuchillo Koos.....	335	navaja.....	49
Masing retractor nasal.....	447	Micro Friedmann pinza gubia.....	234	Neff meniscotomo.....	292
Masing-Neivert retractor nasal.....	447	micro pinza auricular.....	413, 414, 415	Negus pinza para coger amígdalas.....	467
Masson porta aguja.....	210	micro pinzas.....	86, 94	Negus soporte de pecho.....	459
Maxtin pinza muscular.....	479	micro porta aguja Barraquer.....	216, 217	Neivert porta aguja.....	208
Mathieu especulo rectal.....	560	micro porta aguja Barraquer-Troutman.....	216	Neivert-Anderson cincel nasal.....	442
Mathieu pinza para cuerpos extraños.....	553/1	micro porta aguja Castroviejo-Standard.....	216	Nelaton sonda.....	199
Mathieu porta aguja.....	213	micro tijera Circumflex.....	76	Nelson (Standard) trocar abdominal.....	204
Mathieu separador.....	141	micro tijera Gomel.....	80	Nelson aguja para ligadura.....	219
Mathieu-Olsen porta aguja.....	212	micro tijera Hepp-Scheidel.....	78	Nelson pinza de diseccion.....	89
Matson periostotomo.....	279	micro tijeras.....	76, 77, 78	Nelson trocar.....	205
Matson-Alexander periostotomo.....	279	micro tijeras REDA.....	77, 80	Neonatal pinza vascular.....	523
Mauder garrote de madera.....	459	Microvascular porta aguja.....	210	News gancho para traqueotomia.....	477
Maxi Grasper pinza para biopsia.....	593	Middeldorf separador.....	160	Nissen pinza hemostatica.....	113
May oftalmoscopio UNI II.....	14	Middleton-Jansen pinza para tabique nasal.....	430	Norfolk / Norwich separador.....	172
Mayfield pinza gubia.....	238	Mikulicz pinza intestinal.....	543	Northbent tijera.....	66
Mayo baja-lengua.....	451	Mikulicz pinza para peritoneo.....	123	Norwich / Norfolk separador.....	172
Mayo clip para esterilizacion.....	227, 624	Mikulicz separador.....	163	Noto pinza para polipos uterinos.....	585
Mayo cuchara para calculos biliares.....	534	MILLER laringoscopio.....	30	NOVA esfigmomanometro.....	7
Mayo pinza de diseccion.....	89	Milligan elevador para duramadre.....	332	Novak cureta aspiradora para biopsia uterina.....	587
Mayo sonda para calculos biliares.....	534	Millin pinza de agarre para capsula.....	550, 551	NOVA-PRESAMETER esfigmomanometro.....	6
MAYO tijera de diseccion.....	52	Millin pinza para ligadura.....	551	Noyes pinza para polipos.....	425
Mayo tijera supercut.....	71	Millin pinza para lobo anterior.....	551	Noyes tijera para iris.....	75
Mayo-Adams separador.....	171	Millin separador cuello vejiga.....	553	O	
Mayo-Blake pinza para calculos biliares.....	531	Millin separador vesical.....	552	Obwegeser elevador.....	461
Mayo-collins separador.....	141	MINI mango de bisturi.....	41	Obwegeser gancho de menton.....	461
Mayo-Guyon pinza hemostatica.....	122	Mini-Lambotte osteotomo.....	262	Obwegeser lezna.....	463, 463/3
Mayo-Haberisser pinza para torcer hilo.....	319	MINIMUS II esfigmomanometro.....	11	Obwegeser osteotomo.....	463
Mayo-Hegar porta aguja.....	209	MINIMUS III esfigmomanometro.....	12	Obwegeser osteotomo de hoja.....	464/1
MAYO-NOBLE tijera de diseccion.....	52	Mini-Townsend-Down pinza para biopsia.....	591	Obwegeser periostotomo.....	462
Mayo-Robson pinza intestinal.....	541	Mini-Townsend-Up pinza para biopsia.....	591	Obwegeser separador manibular.....	461
MAYO-STILLE tijera de diseccion.....	52	Mixer Baby pinza hemostatica.....	119/1	Obwegeser separador para partes blandas.....	460
Mayo-Stille tijera supercut.....	71	Mixer pinza hemostatica.....	116, 119/1, 119/2, 120	Ochsner pinza de diseccion.....	88
Mc Donald elevador.....	283	Mixer pinza para calculos biliares.....	531	Ochsner trocar.....	205
McCullough pinza para estrabismo.....	385	Mixer-O'Shaughnessy pinza hemostatica.....	119/2	O'Conner gancho para iris.....	375
McGee gancho.....	419	Mod. Bonn pinza para sutura.....	386	Oehler pinza de diseccion.....	81/1
McGee pinza auricular micro.....	414	Mod. Muenchen cureta para biopsia.....	587	oftalmoscopio May UNI II.....	14
McGivney ligador para hemorroides.....	568	Mod. Tübingen pinza para ligadura.....	392	Oldberg pinza cortante para laminectomia.....	341
McGivney pinza para hemorroides.....	568	Mod. Tübingen pinza para sutura.....	386	oliva auricular.....	406
McIndoe pinza cortante para huesos.....	241	Mod. USA tijera para cordon umbilical.....	64	oliva auricular Politzer.....	406
McIndoe pinza de diseccion.....	85	Mod. Vienna especulo nasal.....	421	Olivecrona elevador para duramadre.....	332
McIndoe tijera para cartilago.....	65/1	MOELTGEN goniometro.....	25	Olivecrona espátula cerebral.....	336
McINTOSH juego de laringoscopio.....	31	MOLT instrument para circuncision.....	556	Olivecrona pinza gubia.....	237
McINTOSH laringoscopio.....	29	Mollison separador.....	171	Olivecrona sierra hilo.....	332
McIntyre canula lacrimal.....	394	Molt (Doyen-Jansen) abre-boca.....	454	Olivecrona-Toennis pinza aplicadora.....	326
McIvor abre-boca.....	457	Molt periostotomo.....	276	Ollier separador.....	162
McKenty elevador para el tabique nasal.....	437, 438	mondador de tendones Brand.....	294	Olsen-Hegar porta aguja.....	212
McKenzie pinza aplicadora.....	326	Moor cuchara para calculos biliares.....	532	Ombredanne martillo.....	273
McLean forceps obstetrico.....	603	Moore perforador de mano.....	298	osteotomo.....	259-263, 265, 267
McLean-Tucker forceps obstetrico.....	603	Moorfield pinza para sutura.....	392	osteotomo.....	464
McLean-Tucker-Luikart forceps obstetrico.....	603	Morgan proctoscopio.....	565	osteotomo de hoja Obwegeser.....	464/1
McPherson pinza para ligadura.....	392	Moritz-Schmidt baja-lengua.....	452	osteotomo Epker.....	464/2
Mead martillo.....	271	Morris separador.....	164	osteotomo Hibbs.....	265
Mead pinza gubia.....	235	Morris-DeBakey pinza para la aorta.....	506	osteotomo Hoke.....	265
Meeker pinza hemostatica.....	119	Morse separador costal.....	484	osteotomo Lambotte.....	261
Mehdorn pinza para vasos.....	362	Morse-Favaloro separador costal.....	484		
Mellinger blefarostato.....	370	Moynihan explorador apra calculos biliares.....	532		

osteotomo Lexer .....	263	periostotomo Matson .....	279	pinza cortante para huesos Semb .....	242
osteotomo Lexer Mini .....	263	periostotomo Matson-Alexander.....	279	pinza cortante para huesos Stamm .....	241
osteotomo Mini-Lambotte.....	262	periostotomo Molt .....	276	pinza cortante para huesos Stille-Horsley .....	242
osteotomo Obwegeser .....	463	periostotomo Obwegeser .....	462	pinza cortante para huesos Stille-Liston.....	242
osteotomo Stille .....	260	periostotomo Quervain.....	275	pinza cortante para laminectomia Cloward .....	342
Ostroem pinza sacabocado .....	430	periostotomo Sebileau .....	275	pinza cortante para laminectomia Cushing .....	340
O'Sullivan-O'Connor espejulo vaginal .....	576	periostotomo Sedillot .....	274, 275	pinza cortante para laminectomia Ferris-Smith .....	343
O'Sullivan-O'Connor separador abdominal.....	181	periostotomo Seldin .....	277	pinza cortante para laminectomia Love-Gruenwald .....	340
Otis uretrotomo .....	553	periostotomo Semb.....	278	pinza cortante para laminectomia Oldberg .....	341
otoscopio UNI I .....	13	periostotomo Williger .....	276	pinza cortante para laminectomia Schlesinger.....	342
Overholt pinza hemostatica .....	114	Perkins separador .....	168	pinza cortante para laminectomia Spurling .....	340
Overholt-Baby pinza hemostatica.....	114	Perthes escariador .....	304	pinza cortante para laminectomia Wagner .....	343
Overholt-Geissendoerfer pinza hemostatica.....	114	Pestalozza cureta para aborto .....	606	pinza cuticular .....	610
Overholt-Mixer pinza hemostatica .....	115	Petri cubeta .....	620	pinza de agarre .....	305
<b>P</b>					
palanca para doblar placas Lane.....	325	Phaneuf pinza para peritoneo .....	123	pinza de agarre para capsula Millin .....	550, 551
Park bierarostato .....	371	Pierce elevador para el tabique nasal .....	438	pinza de agarre para prostata Young .....	550
Parker separador.....	139	Pierce trocar para seno maxilar .....	204	pinza de agarre para tendones .....	292, 293
Parker-Langenbeck / Us Army separador .....	141	pieza de acomplamiento para curetas aspiradoras.....	600	pinza de agarre para tendones Brand .....	293
Partsch cincel .....	259	Piffard cureta para lupus .....	608	pinza de agarre para tendones Caroll.....	293
Partsch gubia .....	259	PINARD estetoscopio .....	23	pinza de agarre para tendones Jackson.....	292
Partsch martillo .....	271	pinza aplicadora .....	104	pinza de agarre para tendones Kleinert-Kutz .....	294
pasador de tendones Bunell .....	294	pinza aplicadora de clips .....	524, 525	pinza de agarre para tendones Steinmann .....	292
Passow cincel tamponador para huesos.....	260	pinza aplicadora McKenzie .....	326	pinza de aplicacion .....	357-360
Patella pinza para hueso .....	248	pinza aplicadora Olivecrona-Toennis .....	326	pinza de campo .....	132, 133
Paton disecador corneal .....	373	pinza aplicadora Raney .....	327	pinza de campo Backhaus.....	132
Paufique cuchillo para queratoplastica .....	373	pinza aplicadora Smithwick .....	326	pinza de campo Backhaus-Clip .....	132
Paufique pinza para ligadura.....	392	pinza aplicadora Sweet .....	326	pinza de campo Bernhard.....	133
Payr pinza intestinal y estomacal .....	548	pinza aplicadora Gregory .....	517	pinza de campo Doyen .....	133
Payr sonda conductora .....	221	pinza atraumatica REDA .....	111	pinza de campo Jones.....	132
Payr-Baby pinza intestinal y estomacal .....	548	pinza atraumatica Rogers .....	127	pinza de campo Jones-Clip .....	132
Pean pinza hemostatica .....	108, 110	pinza auricular Harken .....	503	pinza de campo Lane .....	133
Peck Joseph tijera face lift .....	73	pinza auricular Hartmann .....	411	pinza de campo Moynihan .....	133
Pederson espejulo vaginal .....	570	pinza auricular Littauer .....	411	pinza de campo Peers .....	132
Peers pinza de campo .....	132	pinza auricular Lucae .....	410	pinza de campo Roeder .....	132
Peet escofina nasal .....	446	pinza auricular micro .....	413, 414, 415	pinza de campo Schaedel.....	132
Peet pinza para espinas .....	92	pinza auricular micro Cos.....	414	pinza de campo Tohuku .....	132
Peikmann pinza porta esponja.....	137	pinza auricular micro Dieter .....	414	pinza de diseccion Adlerkreutz .....	84
pelvimetro Collier .....	605	pinza auricular micro Greven .....	414	pinza de diseccion Adson .....	81/2, 82
pelvimetro Collin .....	605	pinza auricular micro Haugh .....	414	pinza de diseccion Adson-Brown .....	82
pelvimetro Martin .....	605	pinza auricular micro Juers .....	414	pinza de diseccion Adson-DeBakey.....	81/2
Penfield elevador para duramadre .....	333	pinza auricular micro McGee .....	414	pinza de diseccion Bonney .....	88
Pennington elevador para el tabique nasal.....	438	pinza auricular micro Wullstein .....	416	pinza de diseccion Brophy .....	84
Pennington pinza hemostatica.....	109	pinza auricular Tilley .....	411	pinza de diseccion Brown .....	83
Percy retractor para amputacion .....	296	pinza auricular Wilde (Troeltsch).....	410	pinza de diseccion Collin-Duval .....	85
perforacraneo Smellie .....	607	pinza autocentradora para sostener huesos REDA .....	247	pinza de diseccion Cushing .....	83
perforador de mano .....	298, 299, 300, 304	pinza bronquial .....	126	pinza de diseccion Cushing-Taylor .....	87
perforador de mano Bunell .....	299	pinza bronquial Finochietto .....	490	pinza de diseccion Duherssen .....	84
perforador de mano Hudson.....	299	pinza bronquial Harrington .....	490	pinza de diseccion Durante .....	88
perforador de mano Kirschner .....	299	pinza bronquial Lees .....	504	pinza de diseccion Duval .....	85
perforador de mano Moore .....	298	pinza bronquial Price-Thomas .....	490	pinza de diseccion Ferris-Smith.....	85
perforador de mano Ralk .....	300	pinza bronquial Semb .....	491	pinza de diseccion Gerald .....	86, 87
perforador de mano REDA.....	300	pinza capsular Arruga .....	391	pinza de diseccion Gillies.....	86
perforador de mano Stille.....	298	pinza capsular Castroviejo.....	391	pinza de diseccion Graefe.....	83
perforador de mano Stille-Sherman.....	298	pinza capsular Elschinig.....	391	pinza de diseccion Lane .....	84
perforador inicial Crutchfield .....	327	pinza capsular Fuchs .....	391	pinza de diseccion Lerche .....	83
perforador medular .....	322	pinza capsular Gill-Arruga .....	390	pinza de diseccion Mayo .....	89
perforador para femur Kuntscher.....	321	pinza capsular Hess .....	391	pinza de diseccion McIndoe .....	85
perforador para la cavidad medular Kuntscher .....	321	pinza capsular Kalt .....	391	pinza de diseccion modelo ruso .....	85
periostotomo .....	274-280	pinza capsular Schweigger .....	391	pinza de diseccion modelo Strassburger.....	89
periostotomo Alexander .....	276	pinza capsular Terson .....	391	pinza de diseccion Nelson .....	89
periostotomo Cobb .....	280	pinza cierra-tubo .....	129	pinza de diseccion Ochsner .....	88
periostotomo Dingman.....	463	pinza cierra-tubo Bülow-Gunar-Hey .....	130	pinza de diseccion Oehler .....	81/1
periostotomo Doyen.....	278	pinza cierra-tubo Klinikum Berlin .....	129	pinza de diseccion Potts-Smith.....	81, 81/1
periostotomo Farabeuf.....	274	pinza cierra-tubo Presbyterian .....	129	pinza de diseccion Semken .....	86
periostotomo Farabeuf-Collin .....	274	pinza circular .....	432	pinza de diseccion Singley .....	88
periostotomo Fomon .....	277	pinza cortante Hajek-Kofler.....	429	pinza de diseccion Standard .....	81, 81/1
periostotomo Hargis.....	463/2	pinza cortante Kerrison .....	428	pinza de diseccion Stille .....	81, 81/1
periostotomo Joseph .....	277	pinza cortante para hipofisis .....	341	pinza de diseccion Stille-Barraya.....	88
periostotomo König.....	276	pinza cortante para huesos Böher .....	241	pinza de diseccion Taylor .....	87
periostotomo Lambotte.....	274	pinza cortante para huesos Cottle-Kazanjian .....	241	pinza de diseccion USA .....	81, 81/1
periostotomo Langenbeck .....	275	pinza cortante para huesos Liston .....	241	pinza de diseccion Wagensteen .....	89
		pinza cortante para huesos McIndoe .....	241	pinza de diseccion Waugh .....	83
		pinza cortante para huesos Ruskin-Liston .....	241	pinza de proteccion Adson .....	298



pinza de reduction REDA .....	247	pinza hemostatica Lahey .....	119/2, 120	pinza nasal Takahashi .....	427
pinza de relojero .....	90	pinza hemostatica Lawrence .....	119	pinza nasal Troeltsch .....	424
pinza de traccion craneal Crutchfield .....	327	pinza hemostatica Leriche .....	111	pinza nasal Watson-Williams .....	428
pinza dental London-College .....	93	pinza hemostatica Lovelace .....	109	pinza nasal Weil-Blakesley .....	426
pinza dental Meriam .....	93	pinza hemostatica Lower .....	120	pinza nasal Westmacott .....	424
pinza depilatoria Barraquer .....	395	pinza hemostatica Martel .....	110	pinza para aborto Saenger .....	606
pinza depilatoria Beer .....	395	pinza hemostatica Mayo-Guyon .....	122	pinza para aborto Winter .....	606
pinza depilatoria Douglas .....	395	pinza hemostatica Meeker .....	119	pinza para agarrar el bocio Lahey .....	479
pinza depilatoria Gradle .....	395	pinza hemostatica Mixter .....	116, 119/1, 119/2, 120	pinza para amigdalas Marschik .....	468
pinza depilatoria Littauer .....	395	pinza hemostatica Mixter Baby .....	119/1	pinza para anastomosis Beck .....	516, 520
pinza depilatoria REDA .....	395	pinza hemostatica Mixter-O'Shaugnessy .....	119/2	pinza para anastomosis Cooley .....	519, 520
pinza estomacal Lane .....	547	pinza hemostatica Moynihan .....	120	pinza para anastomosis Cooley-Derra .....	519
pinza gubia Adson .....	236	pinza hemostatica Nissen .....	113	pinza para anastomosis De Martel-Wolfson .....	546
pinza gubia Bane-Hartmann .....	237	pinza hemostatica Overholt .....	114	pinza para anastomosis DeBaKey .....	505, 515
pinza gubia Beyer .....	237, 238	pinza hemostatica Overholt-Baby .....	114	pinza para anastomosis del recto Hayes .....	545
pinza gubia Blumenthal .....	236	pinza hemostatica Overholt-Geissendoerfer .....	114	pinza para anastomosis Derra .....	515
pinza gubia Böhler .....	238	pinza hemostatica Overholt-Mixter .....	115	pinza para anastomosis Lambert-Kay .....	505
pinza gubia Cleveland .....	235	pinza hemostatica Pean .....	108, 110	pinza para anastomosis Potts .....	493
pinza gubia Echlin .....	240	pinza hemostatica Pennington .....	109	pinza para aneurisma de la aorta DeBaKey .....	496, 497, 498
pinza gubia Friedmann .....	234	pinza hemostatica Pratt .....	110	pinza para aneurisma DeBaKey-Bahnsen .....	506
pinza gubia Friedmann mini .....	234	pinza hemostatica Providence-Hospital .....	106	pinza para apendice Allen .....	544
pinza gubia Frykholm .....	240	pinza hemostatica Roberts .....	117	pinza para apendice Kleinschmidt .....	544
pinza gubia Jansen .....	237	pinza hemostatica Rochester-Carmalt .....	109	pinza para aplicar agrafes Childe .....	224
pinza gubia Kleiner-Kutz .....	237	pinza hemostatica Rochester-Ochsner .....	108	pinza para aplicar agrafes Hegenbarth .....	224
pinza gubia Leksell (Stille) .....	240	pinza hemostatica Rochester-Pean .....	108	pinza para aplicar agrafes Michel .....	224
pinza gubia Lempert .....	237	pinza hemostatica Rumel .....	117	pinza para aplicar agrafes Wachenfeldt .....	224
pinza gubia Luer .....	236	pinza hemostatica Sarot .....	118	pinza para aplicar y quitar agrafes Michel .....	224
pinza gubia Marquardt .....	239	pinza hemostatica Spencer-Wells .....	109	pinza para arrancar uñas Radolf .....	297
pinza gubia Mayfield .....	238	pinza hemostatica Stille .....	122	pinza para arrancar vendaje enyesado Wolff .....	233
pinza gubia Mead .....	235	pinza hemostatica Toennis .....	117	pinza para biopsia Alexander .....	589
pinza gubia Micro Friedmann .....	234	pinza hemostatica Tuffier .....	110	pinza para biopsia Baby Burke .....	590
pinza gubia Olivecrona .....	237	pinza hemostatica Wikstroem .....	117	pinza para biopsia Baby-Tischler .....	592
pinza gubia Ruskin .....	239	pinza hemostatica Willet Martel .....	110	pinza para biopsia Burke .....	590
pinza gubia Sauerbruch .....	240	pinza hemostatica Zenker .....	118	pinza para biopsia Eppendorfer .....	590
pinza gubia Scaglietti .....	240	pinza intestinal Allis .....	537	pinza para biopsia Faure .....	588
pinza gubia Semb .....	240	pinza intestinal Allis-Aclair .....	537	pinza para biopsia Kevorkian .....	589, 591
pinza gubia Smith-Petersen .....	238	pinza intestinal Allis-Baby .....	537	pinza para biopsia Kevorkian-Pacific .....	592
pinza gubia Stellbrink .....	234	pinza intestinal Babcock .....	539	pinza para biopsia Maxi Grasper .....	593
pinza gubia Stille-Luer .....	239	pinza intestinal Baby-Kocher .....	540	pinza para biopsia Mini-Townsend-Down .....	591
pinza gubia Stille-Ruskin .....	239	pinza intestinal Boys-Allis .....	538	pinza para biopsia Mini-Townsend-Up .....	591
pinza gubia Zaufal-Jansen .....	238	pinza intestinal Brunner .....	543	pinza para biopsia rectal Turrel .....	567
pinza hemorroidal Heywood-Smith .....	567	pinza intestinal Doyen .....	540	pinza para biopsia rectal Yeoman .....	566, 567
pinza hemostatica Adson .....	112, 113	pinza intestinal Doyen-Baby .....	540	pinza para biopsia Schubert .....	588
pinza hemostatica Adson Baby .....	113	pinza intestinal Fehland .....	542	pinza para biopsia Schumacher .....	588, 589
pinza hemostatica atraumatica DeBaKey-Mosquito .....	509	pinza intestinal Judd-Allis .....	538	pinza para biopsia Serpentine Grasper .....	593
pinza hemostatica atraumatica DeBaKey-Pean .....	513	pinza intestinal Kocher .....	540	pinza para biopsia Thomas-Gaylor .....	588
pinza hemostatica atraumatica DeBaKey-Rankin .....	512	pinza intestinal Littlewood .....	538	pinza para biopsia Tischler-Down .....	591
pinza hemostatica Bainbridge .....	119/2	pinza intestinal Lockwood-Allis .....	538	pinza para biopsia Tischler-Kevorkian .....	592
pinza hemostatica Bengolea .....	112	pinza intestinal Mayo-Robson .....	541	pinza para biopsia Tischler-Morgan .....	590, 591
pinza hemostatica Birkett .....	116	pinza intestinal Mikulicz .....	543	pinza para biopsia Tischler-Up .....	591
pinza hemostatica Bridge .....	116	pinza intestinal Resano .....	542	pinza para biopsia Townsend .....	591
pinza hemostatica Chaput .....	110	pinza intestinal Scudder .....	541	pinza para biopsia van Doren .....	588
pinza hemostatica Collier-Crile .....	106	pinza intestinal Stone-Watt .....	545	pinza para biopsia Wittner .....	589
pinza hemostatica Collin .....	110	pinza intestinal Thoms-Allis .....	538	pinza para bronco-esofagoscopia Chevalier-Jackson .....	473
pinza hemostatica Crafoord .....	118	pinza intestinal y estomacal Payr .....	548	pinza para calculos biliares Blake .....	531
pinza hemostatica Crafoord-Sellors .....	119	pinza intestinal y estomacal Payr-Baby .....	548	pinza para calculos biliares Desjardins .....	531
pinza hemostatica Crile .....	107	pinza maleolar .....	247	pinza para calculos biliares Mayo-Blake .....	531
pinza hemostatica Crile-Rankin .....	107	pinza muscular Berke .....	389	pinza para calculos biliares Mixter .....	531
pinza hemostatica Dandy .....	109	pinza muscular Mastin .....	479	pinza para calculos renales Heiming .....	536
pinza hemostatica Desjardins .....	121	pinza muscular Prince .....	386	pinza para calculos renales Randall .....	535
pinza hemostatica Fergusson .....	109	pinza muscular Snellen .....	393	pinza para campo Ball and Socket .....	133
pinza hemostatica Fuchsig .....	113	pinza nasal Bruenings .....	425	pinza para campo Loma .....	133
pinza hemostatica Gemini .....	115	pinza nasal Hartmann .....	424, 427	pinza para capsuloridectomia Holth .....	380
pinza hemostatica Gray .....	121	pinza nasal Heymann .....	425	pinza para cartilagos Martin .....	246
pinza hemostatica Guyon .....	122	pinza nasal Heymann-Knight .....	425	pinza para cateter Cooley .....	510
pinza hemostatica Halsted-Mosquito .....	105	pinza nasal Jansen .....	424	pinza para cerrar clamps De Martel-Wolfson .....	546
pinza hemostatica Hartmann .....	104	pinza nasal Jansen-Gruenwald .....	424	pinza para cerrar clamps Stone .....	545
pinza hemostatica Heiss .....	112	pinza nasal Knight .....	425	pinza para chalazion Desmarres .....	393
pinza hemostatica Johns-Hopkins .....	120	pinza nasal Lubet-Barbon .....	424	pinza para chalazion Lambert .....	393
pinza hemostatica Kantrowitz .....	119/1	pinza nasal Luc .....	426	pinza para coartacion Potts .....	492
pinza hemostatica Kelly .....	106	pinza nasal Myles .....	427	pinza para coger amigdalas Abraham .....	468
pinza hemostatica Kelly-Rankin .....	106	pinza nasal Schmeden .....	427	pinza para coger amigdalas Ballenger .....	467
pinza hemostatica Kocher .....	108	pinza nasal Struycken .....	427	pinza para coger amigdalas Blohmke .....	467

pinza para coger amígdalas Colver .....	467	pinza para introducir cateter MAGILL .....	28	pinza para torcer hilo Berry .....	319
pinza para coger amígdalas Negus .....	467	pinza para iris Barraquer (Colibri) .....	384	pinza para torcer hilo Corwin-Hegar .....	319
pinza para coger amígdalas Tyding .....	468	pinza para iris Barraquer-Katzin .....	384	pinza para torcer hilo Mayo-Haberisser .....	319
pinza para coger amígdalas White .....	467	pinza para iris Bishop-Harman .....	386	pinza para tracomia Knapp-Luer .....	393
pinza para coger el pulmon Lovelace .....	490	pinza para iris Colibri .....	384	pinza para tumores Landolt .....	341
pinza para coger las amígdalas Sawtell .....	467	pinza para iris Fischer .....	384	pinza para tumores Yasargil .....	97
pinza para coger las amígdalas Schmidt .....	467	pinza para iris Foerster .....	383	pinza para uso multiple Glover .....	515
pinza para columna Cottle .....	448	pinza para iris Gill .....	384	pinza para utero Green-Armytage .....	605
pinza para cordón espermático .....	553/2	pinza para iris Gill-Hess .....	384	pinza para vasectomía .....	553/2
pinza para cuerpos extraños Mathieu .....	553/1	pinza para iris Graefe .....	382	pinza para vasos Biemer .....	361
pinza para desechos Sauerbruch .....	227	pinza para iris Hess .....	384	pinza para vasos Mehdorn .....	362
pinza para el pene Stockmann .....	553/1	pinza para iris Stevens .....	383	pinza para vasos periféricos DeBakey .....	494
pinza para el pene Strauss .....	553/1	pinza para iris Troutman .....	389	pinza para vasos periféricos Leland-Jones .....	494
pinza para el tunel del tendón .....	293	pinza para iris Troutman (Colibri) .....	384	pinza para vasos Satinsky .....	491
pinza para el útero Collin .....	585	pinza para la aorta Dietrich .....	510	pinza porta esponja Bozemann .....	138
pinza para el útero Dartigues .....	585	pinza para la aorta Morris-DeBakey .....	506	pinza porta esponja Bozemann-Douglas .....	138
pinza para el útero Somer .....	585	pinza para la aorta Subramanian .....	521	pinza porta esponja Cheron .....	137
pinza para enderezar el tabique nasal Asch .....	449	pinza para la aorta Subramanian-Miniature .....	521	pinza porta esponja Collin .....	137
pinza para enderezar el tabique nasal Walsham .....	449	pinza para la aorta Weber .....	501	pinza porta esponja Lister (Sinus) .....	137
pinza para espinas Archer .....	92	pinza para laringe Fraenkel .....	471	pinza porta esponja Pelkmann .....	137
pinza para espinas Carmalt .....	91	pinza para ligadura Ayer .....	393	pinza porta-esponja Duplay .....	134
pinza para espinas Feilchenfeld .....	91	pinza para ligadura DeBakey .....	493	pinza porta-esponja Gross-Maier .....	134
pinza para espinas Hunter .....	91	pinza para ligadura DeBakey .....	499, 500	pinza porta-esponja Sims-Maier .....	134
pinza para espinas Peet .....	92	pinza para ligadura McPherson .....	392	pinza sacabocado Citelli .....	430
pinza para espinas Stieglitz .....	92	pinza para ligadura Millin .....	551	pinza sacabocado craneal Cone .....	331
pinza para espinas Virtus (Ralk) .....	92	pinza para ligadura Mod. Tübingen .....	392	pinza sacabocado craneal DeVilbiss .....	332
pinza para esterilización .....	227	pinza para ligadura Pauflique .....	392	pinza sacabocado Hajek-Kofler .....	431
pinza para esterilización Cheatle .....	227	pinza para ligadura y la aorta DeBakey-Semb .....	499	pinza sacabocado Ostroem .....	430
pinza para esterilización de jeringas Davis .....	227	pinza para lobo anterior Millin .....	551	pinza sacabocado para discos intervertebral	
pinza para esterilización Rogge .....	227	pinza para magullar tabique Rubin .....	428	Colclough .....	344/1
pinza para esterilización Universal .....	227	pinza para medicación Bryant .....	137	pinza sacabocado para discos intervertebral	
pinza para estrabismo Bonaccolto .....	385	pinza para microcirugía .....	96	Ferris-Smith-Kerrison .....	344, 344/2
pinza para estrabismo Dastoor .....	386	pinza para micro-cirugía de la laringe .....	474	pinza tira-lengua Collin .....	453
pinza para estrabismo Jameson .....	385	pinza para oclusión tangencial DeBakey-Satinsky .....	502	pinza tira-lengua Young .....	453
pinza para estrabismo McCullough .....	385	pinza para pedículo Herrick .....	123	pinza uterina Barrett .....	582
pinza para fijación Barraquer .....	390	pinza para pericraqueo Gauss .....	605	pinza uterina Braun .....	582
pinza para fijación Castroviejo .....	390	pinza para peritoneo Faure .....	123	pinza uterina Czerny .....	584
pinza para fijación Cottle .....	410	pinza para peritoneo Mikulicz .....	123	pinza uterina Duplay .....	582
pinza para fijación Elschmig .....	389	pinza para peritoneo Phaneuf .....	123	pinza uterina Hulka .....	583
pinza para fijación Graefe .....	389	pinza para polipos Hartmann .....	412	pinza uterina Iowa .....	584
pinza para fijación Green .....	390	pinza para polipos Hartmann-Hoffmann .....	412	pinza uterina Jacobs .....	583
pinza para fijación Kirby-Arthur .....	385	pinza para polipos Hartmann-Wullstein .....	412	pinza uterina Jarcho .....	583
pinza para fijación Lester .....	389	pinza para polipos laringeos Jurasz .....	471	pinza uterina Museux .....	583
pinza para hemorroides McGivney .....	568	pinza para polipos Littauer .....	425	pinza uterina Pratt .....	584
pinza para hipofisis Adson .....	334	pinza para polipos Noyes .....	425	pinza uterina Schröder .....	584
pinza para histerectomía Heaney .....	126	pinza para polipos Struempel .....	412	pinza uterina Schroeder .....	583
pinza para histerectomía Heany-Ballentine .....	127	pinza para polipos uterinos Doyen .....	585	pinza uterina Schroeder (Pozzi) .....	582
pinza para histerectomía Holzbach .....	126	pinza para polipos uterinos Kelly .....	585	pinza uterina Skene .....	582
pinza para histerectomía Segond .....	125	pinza para polipos uterinos Noto .....	585	pinza uterina Stauda-Moore .....	582
pinza para histerectomía Segond-Landau .....	125	pinza para quitar agrafes Collin .....	224	pinza uterina Teale .....	583
pinza para histerectomía Wertheim .....	124, 128	pinza para quitar agrafes Richter-Heath .....	224	pinza vascular .....	526
pinza para histerectomía Wertheim-Cullen .....	125	pinza para reducción .....	246	pinza vascular Cooley .....	520
pinza para hueso Bircher-Ganske .....	246	pinza para reposición Rowe .....	459	pinza vascular de uso multiple Bainbridge .....	495
pinza para hueso Dingmann .....	246	pinza para secuestros .....	249	pinza vascular de uso multiple Cooley .....	518-520
pinza para hueso Farabeuf .....	243	pinza para secuestros VAN Buren .....	249	pinza vascular de uso multiple DeBakey	
pinza para hueso Farabeuf-Lambotte .....	243	pinza para senescopia .....	431	.....495, 507, 508, 514, 515	
pinza para hueso Fergusson .....	243	pinza para shunt carotido Javid .....	511	pinza vascular Neonatal .....	523
pinza para hueso Kern .....	244	pinza para sostener placas Lane .....	325	pinza vascular para neomales Castaneda .....	527
pinza para hueso Lambotte .....	244	pinza para sostener tornillos Lane .....	325	pinza vascular pediátrica Cooley .....	522
pinza para hueso Lane .....	244	pinza para sutura Castroviejo .....	392	pinza vascular pediátrica DeBakey .....	516, 517
pinza para hueso Langenbeck .....	243	pinza para sutura Mod. Bonn .....	386	pinzas traumáticas DeBakey .....	98, 99
pinza para hueso Lewin .....	246	pinza para sutura Mod. Tübingen .....	386	pinzas de disección .....	81, 81/1
pinza para hueso Patella .....	248	pinza para sutura Moorfield .....	392	pinzas para espinas .....	91, 92
pinza para hueso REDA .....	246	pinza para sutura St. Martin .....	392	pinzas Ultra-Ligera .....	95
pinza para hueso Reill .....	248	pinza para tabique nasal Graig .....	426	Piper forceps obstétrico .....	604
pinza para hueso Semb .....	243	pinza para tabique nasal Middleton-Jansen .....	430	Pistola lavadora .....	626
pinza para hueso Ulrich .....	248	pinza para tapones .....	135	placa para extender la piel .....	49
pinza para hueso Verbrugge .....	245	pinza para tapones Jackson .....	471	placa para párpado Jaeger .....	371
pinza para huesos autocentrantes .....	245	pinza para tapones Ulrich .....	135	plato para tabletas .....	621
pinza para huesos Feldheim .....	249	pinza para tejido Collin .....	539	Plester cuchillo .....	418
pinza para huesos Lambert-Lowman .....	249	pinza para tejido Duval .....	539	Plester separador .....	171
pinza para huesos Lowman .....	249	pinza para tejido Williams .....	539	Plester tubo de aspiración .....	338
pinza para huesos Lowman-Hoglund .....	249	pinza para tendones Larsen .....	292	polipotomo Krause .....	433/2

polipotomo Krause-Voss.....	433/2	Pratt especulo rectal.....	559	Reill pinza para hueso.....	248
polipotomo Wilde.....	433/2	Pratt pinza hemostatica.....	110	Reiner cuchillo para vendaje enyesado.....	233
Politzer aguja para paracentesis.....	408	Pratt pinza uterina.....	584	Reiner jeringa auricular.....	406
Politzer cuchillo auricular.....	408	Pratt sonda para fistula.....	563	Resano pinza intestinal.....	542
Politzer especulo auricular.....	399	PRECISA esfigmomanometro.....	9	RESANO tijera para capsula.....	53/2
Politzer oliva auricular.....	406	Presbyterian pinza cierra-tubo.....	129	retractor nasal Aufricht.....	447
POOLE tubo de aspiracion.....	27	Price-Thomas pinza bronquial.....	490	retractor nasal Cottle.....	447, 447/1
porta aguja (micro) Barraquer.....	216, 217	Prince pinza muscular.....	386	retractor nasal Kliner.....	447/1
porta aguja (micro) Barraquer-Troutmann.....	216	PRINCE tijera para amigdalas.....	59	retractor nasal Masing.....	447
porta aguja (micro) Castroviejo-Standard.....	216	proctoscopio Bensaude.....	565	retractor nasal Masing-Neivert.....	447
porta aguja Adson.....	211	proctoscopio Fansler.....	564	retractor para amputacion Percy.....	296
porta aguja Arruga.....	214	proctoscopio Kelly.....	562, 563	Reverdin aguja.....	220
porta aguja Baby-Olsen-Hegar.....	212	proctoscopio Morgan.....	565	Reverdin separador abdominal.....	143/1
porta aguja Baumgartner.....	208	protector Arruga.....	378	REYNOLDS tijera para cirugia.....	54
porta aguja Boynton.....	214	Providence-Hospital pinza hemostatica.....	106	Reynolds tijera supercut.....	72
porta aguja Bozemann.....	211	punta de pinza Baracani.....	472	Ribbon espátula abdominal.....	143
porta aguja Brown.....	209	punta de pinza Bruenings.....	472	Ricard separador abdominal.....	191
porta aguja Castroviejo.....	215	punta de pinza Cordes.....	472	Richardson Grip separador.....	142
porta aguja Castroviejo-Micro.....	215	punta de pinza Fraenkel.....	472	Richardson separador.....	142
porta aguja Collier.....	208	punta de pinza Krause.....	472	Richardson-Eastman separador.....	142
porta aguja Crile.....	213	punta de pinza Lange.....	472	Richnau-Holmgren especulo auricular.....	400
porta aguja Crile-Murray.....	209	punta de pinza Scheinmann.....	472	Richter-Heath pinza para quitar agrafes.....	224
porta aguja Crile-Wood.....	209	punta de pinza Schumacher.....	472	Rienhoff-Finocchio separador costal.....	486
porta aguja DeBaKey.....	210	punta de pinza Seifert.....	472	Rigby separador.....	189/2
porta aguja DERF.....	208	Putti lima para huesos.....	294	RI-MINI estuche de diagnostico.....	17
porta aguja Finocchio.....	211	Q		Ring baja-lengua.....	455
porta aguja Gillies.....	212	Quervain periototomo.....	275	riñoneras.....	619
porta aguja Halsey.....	208	Quinby tijera para encias.....	67	Ritter-Halle dilatador para el seno.....	433
porta aguja Heaney.....	210	Quire elevador para cuerpos extraños.....	412	Robb disecador vascular.....	530
porta aguja Hoesel.....	213	Quisling martillo.....	271	Robb espátula para la intima.....	530
porta aguja Jacobsen.....	215	quistotomo Becker.....	375	Roberts pinza hemostatica.....	117
porta aguja Johnson.....	211	quistotomo Graefe.....	375	Rochester-Carmalt pinza hemostatica.....	109
porta aguja Kait.....	214	quita hojas.....	42	Rochester-Ochsner pinza hemostatica.....	108
porta aguja Kait-Arruga.....	214	R		Rochester-Pean pinza hemostatica.....	108
porta aguja Kilner.....	212	Radolf pinza para arrancar uñas.....	297	Roeder pinza de campo.....	132
porta aguja Langenbeck.....	213	Ragnell separador.....	140	Roger elevador para el tabique nasal.....	437
porta aguja Lichtenberg.....	213	Ralk (Virtus) pinza para espinas.....	92	Roger pinza traumatica.....	127
porta aguja Masson.....	210	Ralk perforador de mano.....	300	Rogge pinza para esterilizacion.....	227
porta aguja Mathieu.....	213	Rampley porta esponjas.....	136	Rollet cancel para extirpacion.....	374
porta aguja Mathieu-Olsen.....	212	Ramus separador para el ramo.....	461	Rollet gancho.....	375
porta aguja Mayo-Hegar.....	209	Randall cureta aspiradora para biopsia uterina.....	587	rompe hojas CASTROVIEJO.....	45
porta aguja Metzenbaum.....	211	Randall pinza para calculos renales.....	535	rompe hojas REDA.....	45
porta aguja Microvascular.....	210	Raney grapa para cuero cabelludo.....	327	rompe hojas TROUTMAN-CHRIS.....	45
porta aguja Neivert.....	208	Raney pinza aplicadora.....	327	Rose separador.....	140
porta aguja Olsen-Hegar.....	212	raqiotomo.....	267	Rose separador.....	418
porta aguja Ryder.....	210	Ray cureta para hipofisis.....	334	Rosen gancho.....	419
porta aguja Sarot.....	211	Recamier curetas uterinas.....	597	Rosen tubo de aspiracion.....	338
porta aguja Stevens.....	214	REDA cucharilla cortante.....	256	Roser-Koenig abre-boca.....	454
porta aguja Stratte.....	212	REDA cuchillo de hoz.....	435	rotador Bechert.....	379
porta aguja Wangenstein.....	210	REDA cuchillo para amputacion.....	44	Roux Baby separador.....	140
porta aguja Webster.....	208	REDA diapason.....	403	Roux mini separador.....	140
porta aguja Young Boomerang.....	220	REDA especulo nasal.....	423	Roux separador.....	139
porta esponjas Foerster.....	136	REDA Excenter tijera para vendaje.....	69/2	Rowe pinza para reposicion.....	459
porta esponjas Rampley.....	136	REDA gancho.....	150	Rubin cancel nasal.....	440
porta ligadura para tournique.....	528	REDA iman ocular.....	395	Rubin pinza para magullar tabique.....	428
porta pinza de traslado.....	615	REDA instrumento para vendaje enyesado.....	232	Rudd ligador para hemorroides.....	568
porta-algodon Farrell.....	203	REDA micro tijeras.....	77, 80	Rumel pinza hemostatica.....	117
porta-algodon Jobson-Horne.....	203	REDA perforador de mano.....	300	Rumel-belmont tournique.....	528
porta-algodon REDA.....	203	REDA pinza traumatica.....	111	Ruskin pinza gubia.....	239
porta-algodon Tobold.....	203	REDA pinza autocentradora para sostener huesos.....	247	Ruskin-Liston pinza cortante para huesos.....	241
porta-algodon Uckermann.....	203	REDA pinza de reduction.....	247	Russel-Davis baja-lengua.....	458
porta-algon.....	203	REDA pinza depilatoria.....	395	Rydel-Seiffert diapason.....	404
porta-clamps De Martel-Wolfson.....	546	REDA pinza para hueso.....	246	Ryder porta aguja.....	210
portador de luz fria KLEINSASSER.....	36	REDA porta-algodon.....	203	S	
portador de luz HOLINGER.....	37	REDA rompe hojas.....	45	Saalfeld saca comedones.....	608
portador de luz JACKSON.....	37	REDA sierra para abrir anillos.....	297	saca comedones Saalfeld.....	608
POTTS DE MARTEL tijera vascular.....	59	REDA sonda conductora.....	221	saca comedones Schamberg.....	608
Potts pinza para anastomosis.....	493	REDON aguja de guia.....	207	saca comedones Unna.....	608
Potts pinza para coartacion.....	492	Rees tijera face lift.....	73	saca comedones Walton.....	608
Potts-Smith pinza de diseccion.....	81, 81/1	regla.....	25	Sachs elevador para duramadre.....	332
Potts-Smith tijera vascular.....	61	Reichert depresor para epiglottis.....	471	Sachs gancho para nervio.....	329
Pozzi (Schroeder) pinza uterina.....	582			Saenger pinza para aborto.....	606
Pratt dilatador uterino.....	580				

salpingografo Schultze.....	596	separador abdominal Baby Gosset.....	181	separador intra oral L&M.....	463/4
SANVERNERO tijera para cirugía.....	54	separador abdominal Back holder.....	192, 193, 194, 195	separador Israel.....	162
Sarot pinza hemostática.....	118	separador abdominal Balfour.....	182, 183	separador Jackson-Burrows.....	189/2
Sarot porta aguja.....	211	separador abdominal Balfour Baby.....	182, 183	separador Jansen.....	168
Satinsky pinza para vasos.....	491	separador abdominal Balfour-us.....	184	separador Kelly.....	142, 164
Satinsky tijera para vasija.....	65/2	separador abdominal Charnley.....	289	separador Kelly Grip.....	142
Sato cuchillo corneal.....	373	separador abdominal Collin.....	190	separador KOCHER.....	155
Satterlee sierra para amputación.....	296	separador abdominal Collin Loktite.....	191	separador Kocher.....	159, 160, 163
Sauerbruch costotomo.....	481	separador abdominal Denis-Browne.....	185	separador Kocher-Langenbeck.....	159
Sauerbruch pinza gubia.....	240	separador abdominal Doyen.....	189/1	separador Koerte.....	162
Sauerbruch pinza para desechos.....	227	separador abdominal Frazier.....	181	separador König.....	153
Sauerbruch separador.....	164, 166	separador abdominal Gosset.....	181	separador Körte.....	143/1
Sauerbruch-Frey costotomo.....	481	separador abdominal Kirschner.....	185, 187, 187/1	separador Lahay.....	157
Sawtell pinza para coger las amígdalas.....	467	separador abdominal Kümmel.....	143/2	separador Langenbeck.....	158, 159
Sawyer especulo rectal.....	560	separador abdominal O'Sullivan-O'Connor.....	181	separador Langenbeck-Green.....	153
SAVRE elevador.....	281	separador abdominal Reverdin.....	143/1	separador Little.....	157
Scaglietti pinza gubia.....	240	separador abdominal Ricard.....	191	separador Luer.....	140
Scalp-Contour separador.....	169	separador Adson.....	172, 173, 174	separador mamario Breast.....	198
Scapula (Davidson) separador.....	166	separador Alm.....	168	separador mandibular Obwegeser.....	461
Schaedel pinza de campo.....	132	separador Anderson.....	198	separador Martin.....	175/1
Schamberg saca comedones.....	608	separador Anderson Adson.....	172	separador Mathieu.....	141
Scheide cucharilla cortante.....	251	separador Aufranc-Cobra.....	289	separador Mayo-Adams.....	171
Scheie cuchillo para goniotomía.....	373	separador Beckmann.....	176	separador Mayo-Collins.....	141
Scheinmann punta de pinza.....	472	separador BECKMANN-ADSON.....	175	separador Meyerding.....	157, 177, 180
Scherbak especulo vaginal.....	575	separador Beckmann-Eaton.....	176	separador Middeldorf.....	160
Schimmelbusch tambores para esterilización.....	621	separador Brunner.....	167	separador Mikulicz.....	163
SCHINK dermatomo.....	49	separador Caspar.....	179, 180	separador Mollison.....	171
Schioetz tonometro.....	394/2	separador Cloward.....	178	separador Morris.....	164
Schlesinger pinza cortante para laminectomía.....	342	separador Collin.....	139	separador Murphy.....	156
Schmeden pinza nasal.....	427	separador Collin-Hartmann.....	141	separador nasal Converse.....	448
Schmid canula para lavador vascular.....	338	separador Cooley.....	148	separador Norfolk / Norwich.....	172
Schmieden sonda conductora.....	221	separador Coronal Blow Lift.....	198	separador obstetrico Sellheim.....	607
Schmieden-Dick aguja para ligadura.....	219	separador Coryllos (Thorax).....	166	separador Ollier.....	162
Schmieden-Payr sonda conductora.....	221	separador costal Cooley.....	485, 487	separador para cirugía plástica Ferreria.....	197
Schmieden-Taylor tijera duramadre.....	65/1	separador costal De Boer.....	486	separador para cirugía plástica Tebbetts.....	197
Schnidt pinza para coger las amígdalas.....	467	separador costal Finochietto.....	482, 484	separador para cuerpo vertebral Cloward.....	339
Schoenborn separador para la glándula tiroidea.....	479	separador costal Finochietto-Burford.....	483	separador para cuerpo vertebral Inge.....	339
Schröder curetas uterinas.....	595	separador costal Haight.....	487	separador para el borde anterior Hargis.....	463
Schröder pinza uterina.....	584	separador costal Morse.....	484	separador para el cuerpo mandibular Hargis.....	463/6
Schroeder (Pozzi) pinza uterina.....	582	separador costal Morse-Favaloro.....	484	separador para el ramo Ramus.....	461
Schroeder pinza uterina.....	583	separador costal Rienhoff-Finochietto.....	486	separador para el ramo Spina-Nasalis.....	461
Schubert pinza para biopsia.....	588	separador costal Tuffier.....	487	separador para la glándula tiroidea Schoenborn.....	479
Schuhknecht cuchillo.....	418	separador Crile.....	140	separador para la raíz de nervios D'Errico.....	329/2
Schultze salpingografo.....	596	separador cuello vejiga Millin.....	553	separador para la raíz de nervios Hess.....	329/1
Schulze-Bergmann especulo rectal.....	560	separador Cushing.....	151, 152, 153	separador para la raíz de nervios Holsher.....	329/1
Schumacher pinza para biopsia.....	588, 589	separador Darling.....	178	separador para la raíz de nervios Love.....	329/2, 330
Schumacher punta de pinza.....	472	separador Davidson (Scapula).....	166	separador para la raíz de nervios Scoville.....	329/1, 330
Schumacher tijera para cordón umbilical.....	64	separador de movilización Tessier.....	463/3	separador para labios y mejillas.....	453
Schumacher tijera para esternón.....	481	separador de pelvis St. Marks.....	165	separador para labios y mejillas Sternberg.....	453
Schweigger pinza capsular.....	391	separador de sistema Leyla.....	368-368/4	separador para laminectomía Cherry.....	488
Scoville cucharilla cortante.....	253	separador DEEVER.....	145, 146	separador para laminectomía Scoville.....	196
Scoville separador para la raíz de nervios.....	329/1, 330	separador DEEVER GRIP.....	146	separador para laminectomía Scoville-Haverfield.....	196
Scoville separador para laminectomía.....	196	separador DeBakey.....	189/1	separador para menisco Smillie.....	291
Scoville-Haverfield separador para laminectomía.....	196	separador Desmarres.....	151	separador para paladar Nager.....	465
Scudder pinza intestinal.....	541	separador Doyen.....	163	separador para partes blandas Obwegeser.....	460
Sebileau periototomo.....	275	separador Doyen-Stille.....	167	separador para pilar Hofer.....	465
Sedillot periototomo.....	274, 275	separador espinal Taylor.....	291	separador para piloro Benson.....	544
Segond bisturi para fibroma.....	594	separador Farabeuf.....	139	separador para rodilla Blount.....	289
Segond pinza para histerectomía.....	125	separador Finsen.....	168	separador para tejido cervical Cloward.....	339
Segond-Landau pinza para histerectomía.....	125	separador Freeman.....	198	separador para tendones Bunell.....	292
Seifert punta de pinza.....	472	separador Fritsch.....	163	separador para uvula Love.....	465
Seldin periototomo.....	277	separador Gil-Vernet.....	152	separador para yesos Beeson.....	232
Sellheim separador obstetrico.....	607	separador Goelet.....	141	separador para yesos Haglund-Stille.....	232
Semb periototomo.....	278	separador Green.....	160	separador para yesos Henning.....	232
Semb pinza bronquial.....	491	separador Harrington.....	147	separador Parker.....	139
Semb pinza cortante para huesos.....	242	separador Harrington-Pemberton.....	147	separador perineal Gelpi.....	189/1, 189/2
Semb pinza gubia.....	240	separador Heaney.....	164	separador Perkins.....	168
Semb pinza para hueso.....	243	separador Henley.....	170	separador Plester.....	171
Semken pinza de disección.....	86	separador Hibbs.....	164	separador prostático Young.....	550
Semm especulo vaginal.....	571	separador Holzheimer.....	168	separador Ragnell.....	140
Senn-Green separador.....	153	separador Hösel.....	167	separador rectal Smith-Buie.....	561
Senn-Miller separador.....	143	separador intestinal Leriche.....	143/2	separador Richardson.....	142
sensímetro WARTENBERG.....	25	separador intra oral.....	463/1, 463/4	separador Richardson Grip.....	142

separador Richardson-Eastman .....	142	Sinskey gancho .....	376	Stevenson bierarostato .....	371
separador Rigby .....	189/2	Sinus (Lister) pinza porta esponja .....	137	Stieglitz pinza para espinas .....	92
separador Rose .....	140	Sinus sonda para sinoscopia .....	438	Stille (Leksell) pinza gubia .....	240
separador Roux .....	139	sistema de brazo .....	188, 189	Stille cincel .....	260
separador Roux Baby .....	140	Skene pinza uterina .....	582	Stille cizalla para yesos .....	229
separador Roux mini .....	140	Sluder-Ballenger amigdalotomo .....	470	Stille costotomo .....	480
separador sagital Smith .....	463/5	Smellie gancho obstetrico .....	605	Stille gubia .....	260
separador Sauerbruch .....	164, 166	Smellie perforacraneo .....	607	Stille osteotomo .....	260
separador Scalp-Contour .....	169	Smillie meniscotomo .....	292	Stille perforador de mano .....	298
separador Senn-Green .....	153	Smillie separador para menisco .....	291	Stille pinza de diseccion .....	81, 81/1
separador Senn-Miller .....	143	Smith biefarostato .....	370	Stille pinza hemostatica .....	122
separador Simon .....	164	Smith separador sagital .....	463/5	Stille-Barraya pinza de diseccion .....	88
separador Strandell-Stille .....	157	Smith Us Army tijera para gaza .....	69/1	Stille-Horsley pinza cortante para huesos .....	242
separador toracico Mercedes .....	489	Smith-Buie separador rectal .....	561	Stille-Liston pinza cortante para huesos .....	242
separador traqueal Bose .....	476	Smith-Petersen cincel .....	261	Stille-Luer pinza gubia .....	239
separador traqueal Jackson .....	476	Smith-Petersen gubia .....	261	Stille-Ruskin pinza gubia .....	239
separador Travers .....	172	Smith-Petersen pinza gubia .....	238	Stille-Sherman perforador de mano .....	298
separador Tuffier .....	147	Smithwick gancho para nervio .....	329	Stockmann pinza para el pene .....	553/1
separador US ARMY / Parker-Langenbeck .....	141	Smithwick pinza aplicadora .....	326	Stone pinza para cerrar clamps .....	545
separador vesical Judd-Masson .....	552	Snellen asa .....	378	Stone-Watt manguito de cierre .....	545
separador vesical Legueu .....	553	Snellen pinza muscular .....	393	Stone-Watt pinza intestinal .....	545
separador vesical Millin .....	552	Somer pinza para el utero .....	585	STRABISMUS tijera .....	58
separador vesical Thomson-Walker .....	552	sonda abotonada Jacobson .....	335	Strandell-Stille separador .....	157
separador Volkmann .....	153, 154, 156	sonda acanalada .....	199	Strassburger pinza de diseccion .....	89
separador Weitlaner .....	169	sonda acanalada Brodie .....	199	Stratte porta aguja .....	212
separador Weitlaner-Wullstein .....	169	sonda auricular Stacke .....	199	Strauss pinza para el pene .....	553/1
separador Wullstein .....	171	sonda conductora Brunner .....	221	Struempel pinza para polipos .....	412
separador Yancoskie .....	198	sonda conductora Kirschner .....	221	Strully tijera para neurocirugia .....	65
separador Zenker .....	161	sonda conductora Koenig .....	221	Struycken pinza nasal .....	427
Serpentine Grasper pinza para biopsia .....	593	sonda conductora Payr .....	221	Subramanian pinza para la aorta .....	521
serra-fina Dieffenbach .....	104	sonda conductora REDA .....	221	Subramanian-Miniature pinza para la aorta .....	521
serra-fina Johns-Hopkins .....	104	sonda conductora Schmieden .....	221	Supercut tijera Baby Metzbaum .....	71
Seutin tijera para vendaje .....	69/2	sonda conductora Schmieden-Payr .....	221	Supercut tijera Iris .....	72
Sexton cuchillo auricular .....	408	sonda conductora Vienna .....	221	supercut tijera Kilner/Ragnell .....	72
Shambaugh gancho .....	419	sonda Fish .....	199	Supercut tijera La Grange .....	72
Shapleigh asa .....	410	sonda Harms .....	381	supercut tijera Lister .....	72
Shea tijera auricular micro .....	413	sonda lacrimal Bowman .....	381	Supercut tijera Mayo .....	71
Sheehan cincel nasal .....	441	sonda lacrimal Worst .....	381	Supercut tijera Mayo-Stille .....	71
Sheets canula .....	394/2	sonda Nelaton .....	199	Supercut tijera Metzbaum .....	71
Siebenmann dilatador para el seno .....	433/1	sonda para bocio Kocher .....	479	supercut tijera Reynolds .....	72
Siebold tijera ginecologica .....	62	sonda para calculos biliares Mayo .....	534	supercut tijera Stevens .....	72
Siegle especulo auricular .....	402	sonda para fistula Lockhart-Mummery .....	200	supercut tijera wagner .....	72
sierra hilo Olivecrona .....	332	sonda para fistula Pratt .....	563	Supercut tijeras .....	71, 72
sierra nasal Joseph .....	446	sonda para medir House .....	420	Sweet pinza aplicadora .....	326
sierra oscilante con aspiracion .....	231	sonda para sinoscopia Sinus .....	438	SYSTRONIJERA pinza para cirugia .....	66
sierra oscilante para vendajes enyesados .....	230	soporte de esterilizacion para alambres de Kirschner .....	305		
sierra para abrir anillos REDA .....	297	soporte de pecho Negus .....	459		
sierra para abrir anillos Walton .....	297	soporte pectoral KLEINSASSER .....	36	T	
sierra para amputacion Bier .....	296	Spencer tijera para ligadura .....	66	Tabb cuchillo .....	418
sierra para amputacion Charriere .....	296	Spencer-Wells pinza hemostatica .....	109	Takahashi pinza nasal .....	427
sierra para amputacion Langenbeck .....	296	Spinal cucharilla cortante .....	253	taladores .....	302
sierra para amputacion Satterlee .....	296	Spina-Nasalis separador para el ramo .....	461	tambores para esterilizacion Schimmelbusch .....	621
sierra para autopsia .....	231/1, 231/2, 231/3	Spratt cucharilla cortante .....	251	tamponeador Luniatzschek .....	465
sierra para vendajes enyesados Engel .....	229	Spurling pinza cortante para laminectomia .....	340	Tarnier craneoclasto .....	607
sileta .....	621	St. Marks separador de pelvis .....	165	Tarnier forceps obstetrico .....	604
Silver cincel nasal .....	442	St. Martin pinza para sutura .....	392	tarros .....	620
SILVER dermatomo .....	50	St. Clair-Thomson cuchillo para vegetaciones adenoides .....	450	TAYLOR martillo de percusion .....	24
Simcoe canula .....	394/2	Stacke sonda auricular .....	199	Taylor pinza de diseccion .....	87
Simon cucharilla uterina .....	594	Stamm pinza cortante para huesos .....	241	Taylor separador espinal .....	291
Simon separador .....	164	Standard (Nelson) trocar abdominal .....	204	Teale pinza uterina .....	583
Simplex cierra-tubos .....	624	Standard estuche para sutura .....	226	Tebbetts separador para cirugia plastica .....	197
Simpson forceps obstetrico .....	602	Standard pinza de diseccion .....	81, 81/1	tensor de cierra-hilo Demel .....	315
Simpson-Braun forceps obstetrico .....	602	STANDARD tijera para cirugia .....	51	tensor de cierra-hilo Loute .....	315
Simpson-Luikart forceps obstetrico .....	603	Staude-Moore pinza uterina .....	582	tensor de taladros .....	313
Sims curetas uterinas .....	597	Steinmann alambre .....	307, 308	Terson pinza capsular .....	391
Sims depresor uterino .....	586	Steinmann pinza de agarre para tendones .....	292	Tessier separador de mobilizacion .....	463/3
Sims dilatador uterino .....	581	Stellbrink pinza gubia .....	234	Thomas curetas uterinas .....	599
Sims especulo rectal .....	559	Sternberg separador para labios y mejillas .....	453	Thomas-Gaylor pinza para biopsia .....	588
Sims especulo vaginal .....	573	Stevens gancho para cristalino .....	375	Thoms-Allis pinza intestinal .....	538
Sims histerometro .....	586	Stevens pinza para iris .....	383	Thomson-Walker separador vesical .....	552
Sims tijera ginecologica .....	62	Stevens pinza para iris .....	383	Thorax (Coryllos) separador .....	166
Sims-Maier pinza porta-esponja .....	134	Stevens porta aguja .....	214	Thorek tijera vesicula biliar .....	65/2
Singley pinza de diseccion .....	88	STEVENS tijera para tenotomia .....	58	Thudichum especulo nasal .....	421
		Stevens tijera supercut .....	72	Tieck-Halle especulo nasal .....	423

tijera auricular micro Bellucci.....	413, 417	tijera para ligadura Spencer .....	66	transformador para mango de pila para laringoscopio .....	34
tijera auricular micro Shea.....	413	tijera para neurocirugia .....	65	Travers separtor.....	172
tijera corneal AEBLI.....	58	tijera para neurocirugia Strully .....	65	Trelat especulo vaginal .....	571
tijera cuticular .....	610	tijera para oftalmologia.....	57	trepano Keyes .....	608
tijera de diseccion DEEVER .....	52	tijera para oftalmologia.....	75, 79	trocac abdominal Standard (Nelson) .....	204
tijera de diseccion JORGENSEN .....	53	tijera para oftalmologia Barraquer Colibri .....	75	trocac Douglas .....	204
tijera de diseccion LEXER .....	53	tijera para oftalmologia GRADLE .....	57	trocac Nelson .....	205
tijera de diseccion LEXER BABY .....	53	tijera para parametrium .....	63	trocac Ochsner.....	205
tijera de diseccion MAYO.....	52	tijera para preparacion .....	65	trocac para seno maxilar Coakley .....	204
tijera de diseccion MAYO-NOBLE .....	52	tijera para rinoplastia Fomon .....	65/1	trocac para seno maxilar Lichtwitz .....	204
tijera de diseccion MAYO-STILLE .....	52	tijera para septo Killian.....	471	trocac para seno maxilar Pierce .....	204
tijera de diseccion METZENBAUM.....	53/1	tijera para tendon Westcott .....	75	trocac para sinoscopia .....	205
tijera de diseccion WELLER.....	53/2	tijera para tenotomia STEVENS .....	58	trocac Universal .....	204
tijera de incision .....	52	tijera para uñas.....	609, 614	Troeltsch (Wilde) pinza auricular.....	410
tijera DeBakey .....	60	tijera para vasija Klinkenbergh-Loth .....	65/2	Troeltsch pinza nasal.....	424
tijera duramadre Schmieden-Taylor .....	65/1	tijera para vendaje .....	69/1, 69/2, 70	TROEMNER martillo de percusion.....	24
tijera ENUCLEATION .....	58	tijera para vendaje Bergmann .....	69/1	Trousseau-Baby dilatador traqueal .....	476
tijera face lift Freeman .....	73	tijera para vendaje Bruns .....	70	Troutman (Colibri) pinza para iris.....	384
tijera face lift Gorney .....	73	tijera para vendaje Esmarch .....	69/2	Troutman pinza para iris .....	389
tijera face lift Kaye.....	73	tijera para vendaje Knowles .....	70	TROUTMAN-CHRIS .....	45
tijera face lift Peck Joseph.....	73	tijera para vendaje Lister .....	69/1	Tubbs dilatador de aorta .....	528
tijera face lift Rees.....	73	tijera para vendaje Lorenz.....	70	Tübingen pinza para ligadura.....	392
tijera ginecologica Doyen.....	63	tijera para vendaje REDA Excenter .....	69/2	Tübingen pinza para sutura .....	386
tijera ginecologica Dubois.....	63	tijera para vendaje Seutin .....	69/2	tubo de aspiracion .....	337, 337/1, 337/2, 338
tijera ginecologica Siebold.....	62	tijera para vendaje Universal .....	70	tubo de aspiracion Adson.....	338
tijera ginecologica SIMS.....	62	tijera para vesicula biliar Thorek .....	65/2	tubo de aspiracion ANDREW-PYNCHON.....	28
tijera ginecologica Wertheim .....	63	tijera pulmonares Crafoord .....	65/2	tubo de aspiracion BABY-YANKAUER .....	27
tijera Martin-Carilage .....	65/1	tijera STRABISMUS.....	58	tubo de aspiracion COOLEY .....	28
tijera nasal .....	428, 429	tijera supercut Baby Metzenbaum .....	71	tubo de aspiracion Fergusson .....	337
tijera nasal COTTLE .....	59	tijera supercut Iris.....	72	tubo de aspiracion Frazier/Fergusson .....	337
tijera nasal FOMON .....	58	tijera supercut Kilner/Ragnell .....	72	tubo de aspiracion House .....	337/2
tijera nasal HEYMANN .....	58	tijera supercut La Grange.....	72	tubo de aspiracion Plester .....	338
tijera nasal Watson-Williams .....	428	tijera supercut Lister.....	72	tubo de aspiracion POOLE .....	27
tijera Northbent.....	66	tijera supercut Mayo .....	71	tubo de aspiracion Rosen .....	338
tijera para alambre y laminas Universal .....	67	tijera supercut Mayo-Stille .....	71	tubo de aspiracion Yasarigi.....	337/1
tijera para amigdalas.....	59	tijera supercut Metzenbaum.....	71	tubo de aspiracion Zöllner .....	337/1
tijera para amigdalas BOETTCHER.....	59	tijera supercut Reynolds.....	72	tubo de extension Bruenings .....	472
tijera para amigdalas DEAN .....	59	tijera supercut Stevens.....	72	tubos de aspiracion YANKAUER.....	27
tijera para amigdalas GOOD .....	59	tijera supercut Wagner .....	72	Tuffier pinza hemostatica .....	110
tijera para capsula RESANO .....	53/2	tijera Toennis-Adson .....	65	Tuffier separador.....	147
tijera para cartilago McIndoe .....	65/1	tijera vascular DeBakey.....	61	Tuffier separador costal .....	487
tijera para cirugia COTTLE .....	56	tijera vascular DIETRICH .....	60	Turnbull alicata para cortar uñas.....	609
tijera para cirugia GRAEFFE .....	56	tijera vascular Favaloro .....	61	Turrel pinza para biopsia rectal .....	567
tijera para cirugia IRIS .....	54	tijera vascular Kelly .....	61	Tyding amigdalotomo .....	469
tijera para cirugia JOSEPH.....	54	tijera vascular POTTS DE MARTEL.....	59	Tyding pinza para coger amigdalas .....	468
tijera para cirugia KILNER.....	54	tijera vascular Potts-Smith .....	61		
tijera para cirugia LITTLER.....	55	tijera vasija Satinsky.....	65/2		
tijera para cirugia METZENBAUM.....	54	tijera Wagner .....	67		
tijera para cirugia REYNOLDS .....	54	tijeras para cirugia KNAPP .....	55		
tijera para cirugia SANVERNERO.....	54	tijeras Supercut .....	71, 72		
tijera para cirugia STANDARD .....	51	tijeras vasculares .....	59		
tijera para cirugia Systrunk.....	66	Tilley pinza auricular.....	411		
tijera para cirugia Waldmann.....	66	tirabuzon para fibroma Doyen .....	594		
tijera para cordon umbilical Busch .....	64	Tischler-Down pinza para biopsia .....	591		
tijera para cordon umbilical Mod. USA .....	64	Tischler-Kevorkian pinza para biopsia .....	592		
tijera para cordon umbilical Schuhmacher .....	64	Tischler-Morgan pinza para biopsia .....	590, 591		
tijera para corneas Castroviejo.....	79	Tischler-Up pinza para biopsia .....	591		
tijera para coronas Beebee .....	68	Tobold baja-lengua.....	453		
tijera para encias Goldman-Fox .....	67	Tobold porta-algodon .....	203		
tijera para encias La Grange.....	69	Toennis elevador para duramadre .....	332		
tijera para encias Locklin .....	69	Toennis pinza hemostatica .....	117		
tijera para encias Quinby .....	67	Toennis-Adson tijera .....	65		
tijera para enterotomo.....	66	Tohoku pinza de campo .....	132		
tijera para episiotomia Braun-Stadler .....	64	tonometro Schioetz .....	394/2		
tijera para esternon Schumacher .....	481	Took cuchillo corneal.....	373		
tijera para gaza Smith Us Army .....	69/1	torqueto pneumatico .....	295		
tijera para intestino Fergusson .....	66	tourneque Rumel-Belmont .....	528		
tijera para iridectomia Castroviejo.....	79	TOWNLEY calibre.....	26		
tijera para iridectomia Vannas.....	79	Townsend pinza para biopsia.....	591		
tijera para iris Noyes.....	75	Toynbee especulo auricular.....	399		
tijera para iris Wecker.....	75	tractor Barton .....	603		
tijera para ligadura Heath .....	66	tractor Bill .....	604		
tijera para ligadura Littauer .....	66	tractor Luikart-Bill.....	604		
				U	
				U.S. Kirschner estribo para extension .....	312
				Uckermann porta-algodon .....	203
				Ulrich pinza para hueso .....	248
				Ulrich pinza para tapones .....	135
				UNI I estuche de diagnostico / otoscopio .....	13
				UNI II estuche de diagnostico / oftalmoscopio May.....	14
				UNI III estuche de diagnostico .....	15
				Universal pinza para esterilizacion .....	227
				Universal tijera para alambre y laminas .....	67
				Universal tijera para vendaje .....	70
				Universal trocax .....	204
				Unna saca comedones .....	608
				uretrotomo Otis .....	553
				US Army / Parker-Langenbeck separador .....	141
				USA Mod. tijera para cordon umbilical .....	64
				USA pinza de diseccion.....	81, 81/1
				V	
				V. Petz aparato para suturar estomago y intestinos.....	549
				vaina para tornillos .....	324
				Valleix histerometro .....	586
				Van Buren buija dilatadora .....	554
				Van Buren pinza para secuestros .....	249
				van Doren pinza para biopsia .....	588
				Vannas tijera para iridectomia .....	79
				Varady instrumento para varices.....	202

vasos graduados.....	621	Williger periostotomo .....	276
vendaje de compresion Esmarch.....	296	Winter pinza para aborto.....	606
Verbrugge pinza para hueso .....	245	Wittner pinza para biopsia .....	589
Verbrugge-Müller elevador.....	286/2	Wolff pinza para arrancar vendaje enyesado.....	233
Verres aguja para neumoperitoneo .....	206	Woodson elevador para duramadre.....	333
Vienna especulo nasal.....	421	Worst sonda lacrimal.....	381
Vienna sonda conductora .....	221	Wrigley forceps obstetrico .....	602
VIRCHOW cuchillo para autopsia .....	48	Wullstein cuchillo.....	418
VIRCHOW cuchillo para cerebro.....	48	Wullstein mango de aspiracion .....	338
Virtus (RALK) pinza para espinas .....	92	Wullstein pinza auricular micro .....	416
Volkmann cucharilla cortante.....	251, 257	Wullstein separador.....	171
Volkmann separador .....	153, 154, 156	Wylie dilatador uterino.....	581
Voltoini especulo nasal.....	421		
Vu-More especula vaginal .....	569		
		Y	
W		Yancoskie separador.....	198
Wachenfeldt pinza para aplicar agrafes.....	224	Yankauer elevador para amigdales.....	465
Wadsworth-Todd cauterio .....	378	YANKAUER tubo de aspiracion .....	27
Wagener gancho abotonado.....	409	Yasargil clips para aneurisma .....	345-356
Wagener-Mosher canula para traqueotomia.....	477	Yasargil gancho para galea .....	330
Wagner pinza cortante para laminectomia .....	343	Yasargil pinza para tumores .....	97
Wagner tijera .....	67	Yasargil tubo de aspiracion.....	337/1
Wagner tijera supercut .....	72	Yeoman cierra-nudo rectal.....	566
Waldmann tijera para cirugía.....	64	Yeoman pinza para biopsia rectal .....	566, 567
Wallich cucharilla para aborto.....	607	Young Boomerang aguja .....	220
Walsham pinza para enderezar el tabique nasal .....	449	Young Boomerang porta aguja .....	220
Walton gubia para cuerpos extraños .....	374	Young pinza de agarre para prostata.....	550
Walton saca comedones.....	608	Young pinza tira-lengua.....	453
Walton sierra para abrir anillos.....	297	Young separador prostático .....	550
Wangensteen pinza de diseccion .....	89		
Wangensteen porta aguja .....	210	Z	
WARTENBERG sensimetro .....	25	Zaufal elevador auricular.....	409
WATSON dermatomo .....	50	Zaufal-Jansen elevador auricular.....	409
Watson-Cheyne disecador.....	199	Zaufal-Jansen pinza gubia .....	238
Watson-Cheyne elevador.....	283	Zenker pinza hemostatica.....	118
Watson-Williams pinza nasal.....	428	Zenker separador .....	161
Waugh pinza de diseccion .....	83	Ziegler blefarostato.....	371
Weber asa.....	378	Ziegler cuchillo para discision.....	373
Weber pinza para la aorta .....	501	Ziegler cuchillo para iris .....	372
Webster porta aguja.....	208	Ziegler dilatador lacrimal .....	381
Wecker espátula para iris.....	378	ZIEGLER espejo frontal .....	21
Wecker tijera para iris.....	75	Zielke gubia.....	264
Week blefarostato.....	370	Zöllner tubo de aspiracion .....	337/1
Weil-Blakesley pinza nasal .....	426		
Weitlaner separador .....	169		
Weitlaner-Wullstein separador.....	169		
WELLER tijera de diseccion.....	53/2		
Wells espátula para enucleacion .....	378		
Wertheim pinza para histerectomia.....	124, 128		
Wertheim tijera ginecologica .....	63		
Wertheim-Cullen pinza para histerectomia .....	125		
West cincel nasal .....	442/1		
Westcott tijera para tendon.....	75		
Westmacott pinza nasal .....	424		
Wheeler cuchillo para discision .....	373		
Wheeler espátula para ciclodialisisis.....	379		
White pinza para coger amigdalas.....	467		
Wieder baja-lengua .....	452		
Wiener escofina nasal .....	443		
Wiener gancho para iris .....	375		
Wigmore cuchillo para vendajes enyesados.....	229		
Wikstroem pinza hemostatica.....	117		
Wilde (Troeltsch) pinza auricular.....	410		
Wilde cierra-nudo auricular.....	431/1		
Wilde polipotomo .....	433/2		
Wilder asa.....	378		
Wilder dilatador lacrimal.....	381		
Williams destornillador .....	323		
Willet Martel pinza hemostatica .....	110		
Williams blefarostato .....	370		
Williams pinza para tejido .....	539		
Williger cucharilla cortante.....	255, 257		
Williger martillo .....	271		

ADENOTOMO LA FORCE.....	450	AGO, KOENIG.....	223	AXENFELD CURETTA DA CALAZIO.....	377
AGRAFES, MICHEL.....	224	AGO, REVERDIN.....	220	AYER PINZA PER CALAZIO.....	393
ABBASSALINGUA.....	451	AGO, ROSEN.....	419	<b>B</b>	
ABBASSALINGUA DAVIS-BOYLE.....	455	AGO, YOUNG-BOOMERANG.....	220	BABCOCK PINZA PER AFFERRARE INTESTINI.....	539
ABBASSALINGUA DOUGHTY.....	458	ALAN-PARKS DIVARICATORE ANALE.....	561	BABINSKI MARTELLO DA PERCUSSIONE.....	24
ABBASSALINGUA RUSSEL-DAVIS.....	458	ALDERDYCE ELEVATORE.....	282	BABY BURKE PINZA PER BIOPSIA.....	590
ABBASSALINGUA, ANDREW.....	452	ALESATORE PER FEMORE, KUENTSCHER.....	321	BABY GOSSET DIVARICATORE ADDOMINALE.....	181
ABBASSALINGUA, BRUENINGS.....	451	ALESATORE PER L'APERTURA DEL MIDOLLO, KUENTSCHER.....	321	BABY METZENBAUM SUPERCUT FORBICI.....	71
ABBASSALINGUA, BUCHWALD.....	451	ALEXANDER PERIOSTOTOMO.....	276	BABY TISCHLER PINZA PER BIOPSIA.....	592
ABBASSALINGUA, DINGMANN.....	456	ALEXANDER PINZA PER BIOPSIA.....	589	BABY WEBSTER PORT'AGHI.....	208
ABBASSALINGUA, FRENZEL.....	451	ALEXANDER SCALPELLO.....	259	BABY YANKAUER CANNULA D'ASPIRAZIONE.....	27
ABBASSALINGUA, HARTMANN.....	452	ALEXANDER SGORBIA.....	259	BABY-KOCHER PINZA INTESTINALE.....	540
ABBASSALINGUA, KILNER-DOUGHTY.....	456	ALGESIMETRO, WARTENBERG.....	25	BABY-OLSEN-HEGAR PORT'AGHI.....	212
ABBASSALINGUA, KROENIG.....	451	ALLEN PINZA PER L'APPENDICE.....	544	BABYPHON SFIGMOMANOMETRO.....	10
ABBASSALINGUA, MAYO.....	451	ALLIS PINZA PER AFFERRARE INTESTINI.....	537	BACINELLA.....	619, 620
ABBASSALINGUA, MORITZ-SCHMIDT.....	452	ALLIS-ADAIR PINZA PER AFFERRARE INTESTINI.....	537	BACINELLA PER PLACENTA.....	621
ABBASSALINGUA, TOBOLD.....	453	ALLIS-BABY PINZA PER AFFERARE INTESTINI.....	537	BACINELLA RENIFORMA.....	619
ABBASSALINGUA, WIEDER.....	452	ALLISON SPATOLA PER POLMONE.....	489	BACKHAUS PINZA FISSATELI.....	132
ABRAHAM COLTELLO PER TONSILLE.....	466	ALM DIVARICATORE.....	168	BAILEY APPROSSIMATORE COSTALE.....	489
ABRAHAM PINZA PER TONSILLE.....	468	ALVIS CURETTA PER CORPI ESTRANEI.....	374	BAILEY-BABY APPROSSIMATORE COSTALE.....	489
ACCESSORI DI FISSAZIONE, ANELLI E BARRE.....	195	AMNIOSCOPO.....	601	BAILEY-GIBBON APPROSSIMATORE COSTALE.....	489
ACCESSORI PER SEGA PER AUTOPSIA.....	231/2, 231/3	AMNIOTOMO, BEACHAM.....	586	BAINBRIDGE PINZA EMOSTATICA.....	119/2
ADATTATORE DI ILLUMINAZIONE.....	601	ANDERSON ADSON DIVARICATORE.....	172	BAINBRIDGE PINZA VASCOLARE.....	495
ADLERKREUTZ PINZA VASCOLARE.....	84	ANDREW ABBASSALINGUA.....	452	BAKES DILATATORE BILIARE.....	532
ADSON DIVARICATORE.....	173	ANDREW-PYNCHON TUBO D'ASPIRAZIONE.....	28	BALFOUR BABY DIVARICATORE ADDOMINALE.....	182
ADSON PINZA ANATOMICA.....	82	ANELLI DI GOMMA PER LEGATURA.....	568	BALFOUR DIVARICATORE ADDOMINALE.....	182
ADSON PINZA ANATOMICA.....	82	ANOSCOPO, HIRSCHMANN.....	562	BALFOUR DIVARICATORE ADDOMINALE.....	183
ADSON PINZA CHIRURGICA.....	82	ANSA AURICOLARE, BILLEAU.....	409	BALFOUR-US DIVARICATORE ADDOMINALE.....	184
ADSON BABY PINZA EMOSTATICA.....	113	ANSA AURICOLARE, SHAPLEIGH.....	410	BALL AND SOCKET PINZA FISSATELI.....	133
ADSON DIVARICATORE.....	172	ANSA PER CATERATTA, ARLT.....	378	BALLENGER COLTELLO PER SETTO.....	436
ADSON MICRO PINZA ANATOMICA.....	82	ANSA PER CATERATTA, SNELLEN.....	378	BALLENGER ELEVATORE PER SETTO.....	439
ADSON MICRO PINZA CHIRURGICA.....	82	ANSA PER CATERATTA, WEBER.....	378	BALLENGER PINZA PER TONSILLE.....	467
ADSON PERIOSTOTOMO.....	282	ANSA PER CATERATTA, WILDER.....	378	BANE-HARTMANN PINZA SGORBIA.....	237
ADSON PINZA EMOSTATICA.....	112	ANSA PER POLIPI.....	411	BANGERTER SPATOLA PER CICLODIALISI.....	379
ADSON PINZA PER IPOFISI.....	334	ANSE PER TONSILLE.....	468	BARACANI INSERTO.....	472
ADSON PINZA SGORBIA.....	236	ANTRUM-CURETTA.....	435	BARANY ASSORDITORE.....	405
ADSON PORT'AGHI.....	211	ANVIL TRONCHESINA PER UNGHIE.....	613	BARBARA AGO.....	419
ADSON TENAGLIA PER OSSA.....	298	APPARECCHIATURA DI SUTURA GASTRO-INTESTINALE, V.PETZ.....	549	BARBARA UNCINO.....	419
ADSON TUBO D'ASPIRAZIONE.....	337	APPROSSIMATORE COSTALE, BAILEY.....	489	BARKAN COLTELLO PER GONIOTOMIA.....	373
ADSON UNCINO PER DURAMADRE.....	329	APPROSSIMATORE COSTALE, BAILEY-BABY.....	489	BARNHILL COLTELLO ADENOIDE.....	450
ADSON, DIVARICATORE.....	174	APPROSSIMATORE COSTALE, BAILEY-GIBBON.....	489	BARON CANNULA D'ASPIRAZIONE.....	336
ADSON-BROWN PINZA CHIRURGICA.....	82	APPROSSIMATORE, BIEMER.....	366	BARR SPECOLO RETTALE.....	559
AEBLI FORBICI PER OFTALMOLOGIA.....	58	APPROSSIMATORE, BIEMER-MÜLLER.....	363	BARRAQUER (COLIBRI) PINZA PER IRIDE.....	384
AGHI PER SUTURE.....	222, 223	APRIBOCCA DI LEGNO MAUNDER.....	459	BARRAQUER BLEFAROSTATO.....	370
AGO PER BIOPSIA,FRANKLIN-SILVER.....	206	APRIBOCCA DI LEGNO MAUNDER.....	459	BARRAQUER COLTELLO PER CHERATOPLASTICA.....	373
AGO DI GUIDA, IOWA.....	206	APRIBOCCA, DAVIS-BOYLE.....	455	BARRAQUER FORBICI OCULISTICHE.....	75
AGO DI GUIDA, REDON.....	207	APRIBOCCA, DAVIS-MEYER.....	457	BARRAQUER PINZA DA FISSAZIONE.....	390
AGO DI INTRODUZIONE, OBWEGESER.....	463	APRIBOCCA, DENHART,12CM.....	454	BARRAQUER PINZA DEPIILATORIA.....	395
AGO DI INTRODUZIONE, OBWEGESER.....	463/3	APRIBOCCA, DINGMANN.....	456	BARRAQUER PORT'AGHI.....	216, 217
AGO PASSAFILI, DEMEL.....	315	APRIBOCCA, HEISTER.....	454	BARRAQUER-KATZIN PINZA PER IRIDE.....	384
AGO PER CORPI ESTRANEI.....	374	APRIBOCCA, JENNINGS.....	454	BARRAQUER-TROUTMAN PORT'AGHI.....	216
AGO PER CORPI ESTRANEI, DAVIS.....	374	APRIBOCCA, KILNER-DOUGHTY.....	456	BARRET PINZA PER ABBASSARE IL COLLO DELL'UTERO.....	582
AGO PER CORPI ESTRANEI, FRANCIS.....	374	APRIBOCCA, MCIVOR.....	457	BARTON FORCIPE.....	603
AGO PER CORPI ESTRANEI, LA FORCE.....	374	APRIBOCCA, ROSER-KOENIG 16CM.....	454	BARTON TRATTORE.....	603
AGO PER CORPI ESTRANEI, LEVINSON.....	374	APRIBOCCA, DOYEN-JANSEN(MOLT).....	454	BAUMGARTNER PORT'AGHI.....	208
AGO PER DISCISIONE.....	374	ARCHER PINZA PER SCHEGGE.....	92	BEACHAM AMNIOTOMO.....	586
AGO PER DISCISIONE, BOWMAN.....	374	ARCO PER ESTENSIONE, BOEHLER.....	312	BECHERT ROTATORE PER NUCLEO.....	379
AGO PER INSUFFLAZIONE, VERESS.....	206	ARCO PER ESTENSIONE, KIRSCHNER.....	312	BECK PINZA PER ANASTOMOSI.....	520
AGO PER LEGATURE.....	218	ARCO PER ESTENSIONE, KIRSCHNER US.....	312	BECK PINZA VASCOLARI.....	516
AGO PER LEGATURE SCHMIEDEN-DICK.....	219	ARLT ANSA PER CATERATTA.....	378	BECKER CISTOTOMO.....	375
AGO PER LEGATURE, COOPER.....	219	ARRUGA BLEFAROSTATO.....	370	BECKMANN COLTELLO ADENOIDE.....	450
AGO PER LEGATURE, DESCHAMPS.....	218	ARRUGA CUCCHIAIO PER ASPORTAZIONE RETINALE.....	378	BECKMANN DIVARICATORE.....	176
AGO PER LEGATURE, KRONECKER.....	219	ARRUGA PINZA CAPSULARE.....	391	BECKMANN-ADSON DIVARICATORE.....	175
AGO PER LEGATURE, NELSON.....	219	ARRUGA PORT'AGHI.....	214	BECKMANN-EATON DIVARICATORE.....	176
AGO PER PARACENTESI, LUCAE.....	408	ARRUGA UNCINO ESTRATTORE.....	375	BEEBEE FORBICI PER CORONA.....	68
AGO PER PARACENTESI, POLITZER.....	408	ASCH PINZA PER LA PLASTICA NASALE.....	449	BEER PINZA DEPIILATORIA.....	395
AGO PER TONSILLE.....	470	ASSORDITORE, BARANY.....	405	BEESON DIVARICATORE PER GESSI.....	232
AGO PER TONSILLE, CLAUS.....	466	AUFNAC-COBRA DIVARICATORE.....	289	BEESON DIVARICATORE PER GESSI.....	232
AGO PER TONSILLE, DUPUY-WEISS.....	466	AUFNAC PINZA PER LA PLASTICA NASALE.....	443	BELLUCCI MICRO FORBICI AURICOLARI.....	413
AGO PER TONSILLE, NAGER.....	466	AUFNAC PINZA PER LA PLASTICA NASALE.....	443	BELLUCCI MICRO FORBICI.....	417
AGO POST MORTEM.....	268	AUFNAC PINZA PER LA PLASTICA NASALE.....	447	BENDA PER COMPRESSIONE ESMARCH.....	297
AGO, BARBARA.....	419	AUVARD SPECOLO VAGINALE.....	576		
AGO, KEITH.....	223				



BENDER MODELLATORE PER CHIODI.....	322	BOYNTON PORT'AGHI.....	214	CANNULA D'ASPIRAZIONE PER BIOPSIA, BUIE.....	566
BENGOLEA PINZA EMOSTATICA.....	112	BOZEMANN PINZA PER TAMPONI.....	138	CANNULA D'ASPIRAZIONE POOLE.....	27
BENNETT ELEVATORE PER OSSA.....	283	BOZEMANN PORT'AGHI.....	211	CANNULA D'ASPIRAZIONE ZÖLLNER.....	337/1
BENSAUDE PROCTOSCOPIO.....	565	BOZEMANN-DOUGLAS PINZA PER TAMPONI.....	138	CANNULA D'ASPIRAZIONE, ADSON.....	337
BENSON DIVARICATORE PER PILORO.....	544	BRACCIALE.....	295	CANNULA D'ASPIRAZIONE, ANDREW-PYNCHON.....	28
BERENS CHERATOMO.....	372	BRACCIO PORTALARINGOSCOPIO KLEINSASSER.....	36	CANNULA D'ASPIRAZIONE, BABY-YANKAUER.....	27
BERGMANN FORBICI PER BENDAGGI.....	69/1	BRAND ENUCLEATORE PER TENDINI.....	294	CANNULA D'ASPIRAZIONE, COOLEY.....	28
BERGMANN MARTELLO.....	272	BRAND STRUMENTI PER AFFERRARE TENDINI.....	293	CANNULA D'ASPIRAZIONE, DE BAKEY.....	28
BERKE PINZA MUSCOLARE.....	389	BRAUN CRANIOCLASTO.....	607	CANNULA D'ASPIRAZIONE, FERGUSSON.....	337
BERLINER MARTELLO DA PERCUSSIONE.....	24	BRAUN DEPRESSORE UTERINO.....	586	CANNULA D'ASPIRAZIONE, FRAZIER/FERGUSSON.....	337
BERNHARD PINZA FISSATELI.....	133	BRAUN PINZA PER ABBASSARE IL COLLO		CANNULA D'ASPIRAZIONE, PLESTER.....	338
BERRY PINZA TORCIFILI.....	319	DELL'UTERO.....	582	CANNULA D'ASPIRAZIONE, ROSEN.....	338
BETHUNE COSTOTOMO.....	481	BRAUN UNCINO SPEZZATORE.....	607	CANNULA D'ASPIRAZIONE, YASARGIL.....	337/1
BICCHIERE GRADUATO.....	620	BRAUN-STADLER FORBICI PER EPISIOTOMIA.....	64	CANNULA D'ASPIRAZIONE, HOUSE.....	337/2
BICCHIERE PER MEDICINALI.....	621	BREAST DIVARICATORE PER CHIRURGIA PLASTICA.....	198	CANNULA LARINGEA.....	470
BIEMER APPROSSIMATORE.....	366	BREISKY SPECOLO VAGINALE.....	577	CANNULA OCULISTICA JENSEN.....	394
BIEMER CLIPS PER VASI.....	361	BRIDGE PINZA EMOSTATICA.....	116	CANNULA OCULISTICA MCINTYRE.....	394
BIEMER PINZA POSA CLIPS.....	361,363,364,366	BRISTOW ELEVATORE PER OSSA.....	290	CANNULA OCULISTICA PER IRRIGAZIONE ED	
BIEMER-MÜLLER APPROSSIMATOR.....	363	BRODIE SPECILLO.....	199	ASPIRAZIONE BISHOP-HARMON.....	394/1
BIER SEGA PER AMPUTAZIONE.....	296	BROPHY PINZA ANATOMICA.....	84	CANNULA OCULISTICA, LACRIMAL.....	394
BILL TRATTORE.....	604	BROPHY PINZA CHIRURGICA.....	84	CANNULA PER ASPIRAZIONE GUILLEN.....	433/1
BILLEAU ANSA AURICOLARE.....	409	BROWN PINZA PER TESSUTI.....	83	CANNULA PER BIOPSIA, MENGHINI.....	206
BIRCHER-GANSKE TENAGLIA PER OSSA.....	246	BROWN PORT'AGHI.....	209	CANNULA PER IRRIGAZIONE KILLIAN.....	433, 433/1
BIRKETT PINZA EMOSTATICA.....	116	BRUENINGS COLTELLO PER TONSILLE.....	466	CANNULA PER IRRIGAZIONE SHEETS.....	394/2
BISHOP-HARMAN PINZA PER IRIDE.....	386	BRUENINGS ABBASSALINGUA.....	451	CANNULA PER IRRIGAZIONE, HARTMANN.....	433
BISHOP-HARMON CANNULA OCULISTICA PER		BRUENINGS INSERTO.....	472	CANNULA PER IRRIGAZIONE, SCHMID.....	338
IRRIGAZIONE ED ASPIRAZIONE.....	394/1	BRUENINGS PINZA PER SETTO NASALE.....	425	CANNULA PER IRRIGAZIONE, SIMENMANN.....	433
BISTURI MONOUSO, STERILI.....	43	BRUENINGS SPECOLO AURICOLARE.....	401	CANNULA PER IRRIGAZIONE, SIBCOE.....	394
BISTURI PER FIBROMI, SEGOND.....	594	BRUNETTI SCALPELLO.....	268	CANNULA TRACHEALE, LUER.....	479
BISTURI, MANICO DI METALLO.....	46	BRÜNNINGS-LUCAS SCALPELLO.....	260	CANNULA TRACHEALE, WAGENER-MOSHER.....	477
BLAKE CURETTA UTERINA.....	595	BRÜNNINGS-LUCAS SCALPELLO.....	260	CANNULA TRACHEALE,CHEVALIER-JACK.....	479
BLAKE PINZA PER CALCOLI BILIARI.....	531	BRÜNNINGS-LUCAS SGORBIA.....	260	CANNULA, LICHTWITZ.....	433
BLEFAROSTATO CLARK.....	370	BRUNNER COSTOTOMO.....	481	CAPLAN PINZA NASALE.....	428
BLEFAROSTATO LIEBERMANN.....	371	BRUNNER DIVARICATORE.....	167	CARMALT PINZA PER SCHEGGE.....	91
BLEFAROSTATO, ARRUGA.....	370	BRUNNER PINZA INTESTINALE.....	543	CAROLL PINZA PER AFFERRARE TENDINI.....	293
BLEFAROSTATO, BARRAQUER.....	370	BRUNNER SONDE CONDUTTRICE.....	221	CARPENTER COLTELLO PER TONSILLE.....	465
BLEFAROSTATO, BOWMAN.....	370	BRUNNER SONDE CONDUTTRICE.....	221	CASPAR DIVARICATORE PER SPINA CERVICALE.....	179
BLEFAROSTATO, CASTROVIEJO.....	371	BRUNS CURETTA TAGLIENTE.....	251, 254	CASPAR DIVARICATORE PER SPINA CERVICALE.....	180
BLEFAROSTATO, CRITCHETT.....	370	BRUNS FORBICI PER BENDAGGI.....	70	CASPAR PISTONI.....	258
BLEFAROSTATO, GRAEFE.....	370	BRYANT PINZA PER MEDICATURA.....	137	CASTANEDA NEONATAL PINZA VASCOLARE.....	527
BLEFAROSTATO, LANCASTER.....	371	BUCHWALD ABBASSALINGUA.....	451	CASTROVIEJO BLEFAROSTATO.....	371
BLEFAROSTATO, LISTER-BURCH.....	370	BUCK CURETTA AURICOLARE.....	407	CASTROVIEJO COLTELLO LANCEOLARE.....	372
BLEFAROSTATO, MELLINGER.....	370	BUCK LEVA PER CORPI ESTRANEI.....	412	CASTROVIEJO COMPASSO.....	380
BLEFAROSTATO, MELLINGER-AXENFELD.....	370	BUCK MARTELLO DA PERCUSSIONE.....	24	CASTROVIEJO FORBICI CORNEALI.....	79
BLEFAROSTATO, MUELLER.....	371	BUCK-GRAMCKO ELEVATORE PER OSSA.....	285	CASTROVIEJO PINZA CAPSULARE.....	391
BLEFAROSTATO, MURDOCK.....	370	BUIE CANNULA D'ASPIRAZIONE RETTALE.....	566	CASTROVIEJO PINZA FISSATRICE.....	390
BLEFAROSTATO, PARK.....	371	BULLDOG PINZA MINI DIETRICH.....	101	CASTROVIEJO PINZA PER SUTURA.....	392
BLEFAROSTATO, SMITH.....	370	BULLDOG PINZA, JOHNS-HOPKINS.....	104	CASTROVIEJO PORT'AGHI.....	215
BLEFAROSTATO, STEVENSON.....	371	BULLDOG PINZE ATRAUMATICHE.....	100	CASTROVIEJO ROMPILAMETTE.....	45
BLEFAROSTATO, WEEK.....	370	BÜLOW-GUNAR-HEY PINZA SERRATUBI A RULLI.....	130	CASTROVIEJO SPATOLA PER CICLODIALISI.....	379
BLEFAROSTATO, WILLIAMS.....	370	BUMM CURETTE UTERINI.....	597	CASTROVIEJO-MICRO PORT'AGHI.....	215
BLEFAROSTATO, ZIEGLER.....	371	BUNELL ENUCLEATORE PER TENDINI.....	292	CASTROVIEJO-STANDARD PORT'AGHI.....	216
BLOHMKE PINZA PER TONSILLE.....	467	BUNELL GUIDA PER TENDINI.....	294	CATETERE AURICOLARE, HARTMANN.....	408
BLOUNT ELEVATORE PER GINOCCHIO.....	289	BUNELL PERFORATORE A MANO.....	299	CATETERE METALLICO.....	555
BLOUNT ELEVATORE PER OSSA.....	288	BUNGE CUCCHIAIO PER ESTENTERAZIONE.....	378	CATETERE METALLICO, COXETER.....	555
BLUMENTHAL PINZA SGORBIA.....	236	BUNT PINZA PER STERILIZZAZIONE.....	227	CATLIN AMPUTATIONSMESSN.....	44
BODENHAMMER SPECOLO RETTALE.....	559	BURCH UNCINO DI FISSAZIONE.....	373	CAUTERIO WADSWORTH-TODD.....	378
BOEHLER ARCO PER ESTENSIONE.....	312	BURKE PINZA PER BIOPSIA.....	590	CAVO BIPOLARE.....	633
BOERMA FORCIPE.....	604	BUSHE CURETTA TAGLIENTE.....	256	CESIOIA PER GESSI.STILLE.....	229
BOETTCHER FORBICI PER TONSILLE.....	59	C		CESIOIA PER OSSA STILLE-HORSLEY.....	242
BÖHLER CESIOIA PER OSSA.....	241	CACCIAVITE WILLIAMS.....	323	CESIOIA PER OSSA STILLE-LISTON.....	242
BÖHLER PINZA SGORBIA.....	238	CACCIAVITE, LANE.....	323, 324	CESIOIA PER OSSA, BOEHLER.....	241
BOIES ELEVATORE.....	277	CALAMITA OCULISTICA, REDA.....	395	CESIOIA PER OSSA, LISTON.....	241
BONACCOLTO PINZA PER STRABISMO.....	385	CALIBRO.....	26	CESIOIA PER OSSA, MCINDOE.....	241
BONN PINZA PER IRIDE.....	387	CAMERA D'ARIA.....	295	CESIOIA PER OSSA, RUSKIN-LISTON.....	241
BONNEY PINZA ANATOMICA.....	88	CANDELETTA DILATATRICE, DIETTEL.....	554	CESIOIA PER OSSA, SEMB.....	242
BONNEY PINZA CHIRURGICA.....	88	CANDELETTA DILATATRICE, GUYON.....	554	CESIOIA PER OSSA,COTTLE-K.....	241
BOSE DIVARICATORE TRACHEALE.....	476	CANDELETTA DILATATRICE, VAN BUREN.....	554	CESTELLO.....	623
BOUCHERON SPECOLO AURICOLARE.....	399	CANFIELD COLTELLO PER TONSILLE.....	466	CESTELLO PER ENDOSCOPI.....	623
BOWMAN AGO PER DISCISIONE.....	374	CANNULA DA INIEZIONE.....	36	CESTELLO PER STERILIZZAZIONE.....	622
BOWMAN BLEFAROSTATO.....	370	CANNULA D'ASPIRAZIONE.....	337/1	CHANDLER ELEVATORE.....	282
BOWMAN CHERATOMO.....	372	CANNULA D'ASPIRAZIONE KLEINSASSER.....	36	CHAPUT PINZA PER AFFERRARE TESSUTI.....	110
BOWMAN SPECILLO PER CANALE LACRIMALE.....	381			CHARNLEY DIVARICATORE ADDOMINALE.....	289

CHARRIERE SEGA PER AMPUTAZIONE .....	296	COLTELLO PER AMPUTAZIONE, CATLIN .....	44	CORONAL BLOW DIVARICATORE PER CHIRURGIA PLASTICA.....	198
CHEATLE PINZA PER STERILIZZAZIONE .....	227	COLTELLO PER AMPUTAZIONE, LANGENBECK.....	44	CORWIN-HEGAR PINZA TORCIFILI .....	319
CHELSEA-EATON PROCTOSCOPO .....	563	COLTELLO PER AMPUTAZIONE, REDA.....	44	CORYLLOS COSTOTOMO .....	480
CHERON PINZA PER MEDICATURA .....	137	COLTELLO PER CARTILAGINE E DISSEZIONE, VIRCHOW .....	48	CORYLLOS DIVARICATORE .....	166
CHERRY DIVARICATORE PER LAMINECTOMIA.....	488	COLTELLO PER CARTILAGINI, LANGENBECK .....	47	COS MIKRO-PINZA AURICOLARE.....	414
CHEVALIER-JACKSON CANNULA TRACHEALE.....	479	COLTELLO PER CATARATTA, DEUTSCHMANN .....	371	COSCIALE .....	295
CHEVALIER-JACKSON PINZA PER BRONCO-ESOFAGOSOPIA .....	473	COLTELLO PER CATARATTA, GRAEFE .....	371	COSTOTOMO.....	480
CHIAVE .....	266	COLTELLO PER CERVELLO .....	48	COSTOTOMO SAUERBRUCH-FREY .....	481
CHIAVI .....	313	COLTELLO PER CHERATOPLASTICA, BARRAQUER .....	373	COSTOTOMO, BETHUNE.....	481
CHILDE PINZA PER AGRAFES.....	224	COLTELLO PER CHERATOPLASTICA, PAUFIQUE .....	373	COSTOTOMO, BRUNNER .....	481
CHIODI PER OSSA .....	309	COLTELLO PER DURA MADRE, KOOS .....	335	COSTOTOMO, CORYLLOS .....	480
CHIODI STEINMANN .....	307, 308	COLTELLO PER FALANGI.....	44	COSTOTOMO, GIERTZ-STILLE .....	481
CINELLI SCALPELLO PER SETTO .....	441	COLTELLO PER GESSI, ESMARCH .....	233	COSTOTOMO, GLUCK .....	480
CISTOTOMO, BECKER.....	375	COLTELLO PER GESSI, HOPKINS .....	233	COSTOTOMO, SAUERBRUCH .....	481
CISTOTOMO, GRAEFE .....	375	COLTELLO PER GESSI, REINER .....	233	COSTOTOMO, STILLE.....	480
CITELLI PINZA TAGLIANTE PER SETTO NASALE .....	430	COLTELLO PER GESSI, WIGMORE .....	229	COTTLE COLUMELLA PINZA .....	448
CLAR LAMPADA FRONTALE .....	22	COLTELLO PER GONIOTOMIA, BARKAN .....	373	COTTLE BULLDOG-FORBICI .....	56
CLARK BLEFAROSTATO 8CM .....	370	COLTELLO PER GONIOTOMIA, SCHEIE .....	373	COTTLE COLTELLO NASALE .....	435
CLAUS AGO PER TONSILLE.....	466	COLTELLO PER IRIDE, DEAN .....	372	COTTLE ELEVATORE PER SETTO .....	439
CLAYMAN UNCINO .....	376	COLTELLO PER IRIDE, KNAPP .....	372	COTTLE FORBICI NASALI .....	59
CLEVELAND PINZA SGORBIA .....	235	COLTELLO PER IRIDE, ZIEGLER .....	372	COTTLE MARTELLO .....	273
CLIPS PER ANEURISMA YASARGIL .....	345 - 356	COLTELLO PER MENISCO, NEFF .....	292	COTTLE PINZA DA PRESA.....	410
CLIPS PER VASI, BIEMER .....	361	COLTELLO PER MENISCO, SMILLIE .....	292	COTTLE SCALPELLO PER SETTO .....	440
CLIPS PER VASI, MEHDORN .....	362	COLTELLO PER ORGANI.....	48	COTTLE SPECOLO NASALE .....	423
CLIPS PER VASI, MUELLER .....	364, 365	COLTELLO PER PERIOSTIO CON RASCHINO .....	47	COTTLE UNCINO NASALE .....	447
CLOWARD DIVARICATORE .....	178	COLTELLO PER RESEZIONE.....	47	COTTLE-JOSEPH ELEVATORE PER SETTO .....	439
CLOWARD DIVARICATORE PER CORPI VERTEBRALI .....	339	COLTELLO PER SETTO NASALE, FREER .....	434	COTTLE-KAZANJIAN CESOIA PER OSSA .....	241
CLOWARD PINZA TAGLIANTE PER LAMINECTOMIA.....	342	COLTELLO PER SETTO, BALLENGER .....	436	COTTLE-NEIVERT UNCINO NASALE.....	448
COAKLEY ANTRUM CURETTA.....	449	COLTELLO PER TONSILLE, ABRAHAM .....	466	COXETER CATETERE METALLICO.....	555
COAKLEY TREQUARTO PER SENO MASCELLARE.....	204	COLTELLO PER TONSILLE, BRUENINGS.....	466	CRAFODD-SELLORS PINZA EMOSTATICA .....	119
COBB CURETTA .....	252	COLTELLO PER TONSILLE, CANFIELD .....	466	CRAFODD FORBICI POLMONARE.....	65/2
COBB PERIOSTOTOMO .....	280	COLTELLO PER TONSILLE, CARPENTER .....	465	CRAFODD PINZA EMOSTATICA .....	118
COBB SGORBIA .....	262	COLTELLO PER TONSILLE, DOUGLAS .....	466	CRANIOCLASTO, BRAUN .....	607
COLCLOUGH PINZA TAGLIANTE PER DISCHI INTERVERTEBRALI.....	344/1	COLTELLO PER TONSILLE, FISHER .....	466	CRANIOCLASTO, TARNIER .....	607
COLLER-CRILE PINZA EMOSTATICA .....	106	COLTELLO, PLESTER .....	418	CREGO ELEVATORE .....	282
COLLIER PELVIMETRO.....	605	COLTELLO, ROSEN .....	418	CRILE DIVARICATORE.....	140
COLLIER PORT'AGHI .....	208	COLTELLO, SCHUKNECHT .....	418	CRILE PINZA EMOSTATICA .....	107
COLLIN DINAMOMETRO .....	25	COLTELLO, TABB .....	418	CRILE PORT'AGHI .....	213
COLLIN DIVARICATORE .....	139	COLTELLO,WULLSTEIN.....	418	CRILE UNCINO PER NERVI.....	328
COLLIN DIVARICATORE ADDOMINALE.....	189/1	COLUMELLA PINZA, COTTLE .....	448	CRILE-MURRAY PORT'AGHI.....	209
COLLIN DIVARICATORE ADDOMINALE .....	190	COLVER PINZA PER TONSILLE .....	467	CRILE-RANKIN PINZA EMOSTATICA .....	107
COLLIN ISTEROMETRO .....	586	COMBINAZIONE PER DIAGNOSTICA CON ILLUMINAZIONE ALOGENA, RI-MINI .....	17	CRILE-WOOD PORT'AGHI.....	209
COLLIN LOKTITE DIVARICATORE ADDOMINALE .....	191	COMBINAZIONE PER DIAGNOSTICA CON ILLUMINAZIONE STANDARD ECO "T" .....	16	CRITCHETT BLEFAROSTATO .....	370
COLLIN MARTELLO .....	270	COMBINAZIONE PER DIAGNOSTICA CON ILLUMINAZIONE STANDARD UNI I .....	13	CRUTCHFIELD PERFORATORE .....	327
COLLIN PELVIMETRO .....	605	COMBINAZIONE PER DIAGNOSTICA CON ILLUMINAZIONE STANDARD UNI II .....	14	CRUTCHFIELD PINZA PER TRAZIONE CRANIALE .....	327
COLLIN PINZA OMBELICALE.....	605	COMBINAZIONE PER DIAGNOSTICA CON ILLUMINAZIONE STANDARD UNI III .....	15	CUCCHIAIO AURICOLARE, GROSS .....	409
COLLIN PINZA PER AFFERRARE INTESTINI.....	539	COMPASSO, CASTROVIEJO .....	380	CUCCHIAIO OSTETRICO, SELLHEIM .....	607
COLLIN PINZA PER AFFERRARE L'UTERO .....	585	COMPASSO, IWANSON .....	624	CUCCHIAIO PER ABORTO, CUZZI .....	606
COLLIN PINZA PER AFFERRARE TESSUTI.....	110	COMPRESSORE STONE-WATT .....	545	CUCCHIAIO PER ABORTO, WALLICH .....	607
COLLIN PINZA PER AGRAFES.....	224	CONE PINZA PER CRANIOTOMIA .....	331	CUCCHIAIO PER ASPORTAZIONE RETINALE, ARRUGA.....	378
COLLIN PINZA PER MEDICATURA .....	137	CONNIN-AMSLER MARCATORE .....	380	CUCCHIAIO PER CALCOLI BILIARI MOOR .....	532
COLLIN PINZA TIRALINGUA .....	453	CONVERSE COLTELLO NASALE .....	435	CUCCHIAIO PER CALCOLI BILIARI, DESJARDINS .....	534
COLLIN SPECOLO VAGINALE.....	570	CONVERSE UNCINO NASALE .....	448	CUCCHIAIO PER CALCOLI BILIARI, FERGUSSON .....	533
COLLIN-DUVAL PINZA DA PRESA.....	85	COOLEY DILATATORE .....	528	CUCCHIAIO PER CALCOLI BILIARI, LUER-KOERTE .....	533
COLLIN-HARTMANN DIVARICATORE.....	141	COOLEY CANNULA D'ASPIRAZIONE.....	28	CUCCHIAIO PER CALCOLI BILIARI, MAYO.....	534
COLTELLO ADENOIDE BECKMANN .....	450	COOLEY DIVARICATORE.....	148	CUCCHIAIO PER CATERATTA, DAVIEL .....	377
COLTELLO ADENOIDE, BARNHILL .....	450	COOLEY DIVARICATORE COSTALE.....	487	CUCCHIAIO PER CATERATTA, GRAEFE .....	377
COLTELLO ADENOIDE,ST. CLAIR-THOMSON.....	450	COOLEY PINZA CARDIOVASCOLARE ATRAUMATICA .....	518, 519, 522	CUCCHIAIO PER CATERATTA, KNAPP .....	378
COLTELLO AURICOLARE, POLITZER.....	408	COOLEY PINZA PER CATETERI.....	510	CUCCHIAIO PER ENUCELAZIONE, WELLS .....	378
COLTELLO AURICOLARE, SEXTON .....	408	COOLEY-DERRA PINZA PER ANASTOMOSI .....	519	CUCCHIAIO PER ESTENTERAZIONE, BUNGE .....	378
COLTELLO FALCATO REDA .....	435	COOLEY-NEONATAL DIVARICATORE COSTALE .....	485	CUCCHIAIO PER MEDICINALI .....	621
COLTELLO INTEROSSEO .....	44	COOPER AGO PER LEGATURE .....	219	CUCCHIAIO PER SANGUE .....	268
COLTELLO LANCEOLARE, BERENS.....	372	COPERCHIO PER PADELLA.....	621	CUCCHIAIO UTERINO GOURDET.....	599
COLTELLO LANCEOLARE, BOWMAN .....	372	CORDA DI TRAZIONE .....	201	CUCCHIAIO UTERINO SCHRÖDER .....	595
COLTELLO LANCEOLARE, CASTROVIEJO.....	372	CORDES INSERTO .....	472	CUCCHIAIO UTERINO, SIMON .....	594
COLTELLO LANCEOLARE, JAEGER .....	372			CULLER SPATOLA PER IRIDE .....	378
COLTELLO LANCEOLARE, WHEELER .....	373			CURETTA ANTRUM .....	435
COLTELLO LANCEOLARE, ZIEGLER .....	373			CURETTA ANTRUM, COAKLEY .....	449
COLTELLO NASALE, CONVERSE .....	435			CURETTA AURICOLARE, BUCK .....	407
COLTELLO NASALE, COTTLE .....	435			CURETTA COBB .....	252
COLTELLO PER AMPUTAZIONE LISTON.....	44			CURETTA DA CALAZIO, AXENFELD .....	377

CURETTA DA CALAZIO, HEBRA .....	377	DE BAKEY PINZA VASCOLARE .....	493, 494, 495, 496, 497, 498, 499, 500, 505, 507, 508, 514, 515, 516, 517,	DILATATORE UTERINO PRATT .....	580
CURETTA DA CALAZIO, MEYHOEFER .....	377	DE BAKEY PORT'AGHI .....	210	DILATATORE UTERINO SIMS .....	581
CURETTA PER ABORTO, PESTALOZZA .....	606	DE BAKEY PINZA ATRAUMATICA BULLDOG .....	100	DILATATORE UTERINO WYLIE .....	581
CURETTA PER BIOPSIA ED ASPIRAZIONE .....	600	DE BAKEY, PINZE ATRAUMATICHE .....	98	DILATATORE VASCOLARE DEBAKEY .....	529
CURETTA PER BIOPSIA, HEANY .....	587	DE BOER DIVARICATORE COSTALE .....	486	DINAMOMETRO, COLLIN .....	25
CURETTA PER BIOPSIA, KEVORKIAN .....	587	DE LEE FORCIPE .....	602	DINGMAN ELEVATORE .....	463/3
CURETTA PER BIOPSIA, MOD.MÜNCHEN .....	587	DE MARTEL STRUMENTO CONDUTTRICE .....	330	DINGMANN ABBASSALINGUA .....	456
CURETTA PER BIOPSIA, NOVAK .....	587	DE MARTEL STRUMENTO CONDUTTRICE .....	330	DINGMANN APRIBOCCA .....	456
CURETTA PER BIOPSIA, RANDALL .....	587	DE MARTEL-WOLFSON PINZA PER ANASTOMOSI .....	546	DINGMANN DIVARICATORE .....	463
CURETTA PER CORPI ESTRANEI ALVIS .....	374	DEAN COLTELLO PER IRIDE .....	372	DINGMANN PERIOTOSTOMO .....	463
CURETTA PER IPOFISI .....	334	DEAN FORBICI PER TONSILLE .....	59	DINGMANN TENAGLIA PER OSSA .....	246
CURETTA PER LUPUS, FOX .....	608	DEAVER DIVARICATORE .....	145	DIPLOMAT SFGOMOMANOMETRO .....	5
CURETTA PER LUPUS, PIFFARD .....	608	DEAVER FORBICI PER DISSEZIONE .....	52	DISETTORE CORNEALE, PATON .....	373
CURETTA TAGLIANTE BRUNS .....	251, 254	DEAVER-GRIP DIVARICATORE .....	146	DISETTORE CORNEALE, ELSCHNIG .....	373
CURETTA TAGLIANTE DOPPIA VOLKMANN .....	257	DEBAKEY FORBICI VASCOLARI .....	61	DISETTORE CORNEALE, GILL .....	373
CURETTA TAGLIANTE VOLKMANN .....	251	DEBAKEY FORBICI VASCOLARI TC .....	60	DISETTORE CORNEALE, GREEN .....	374
CURETTA TAGLIANTE WILLIGER .....	255	DEBAKEY PINZA PER ANASTOMOSI .....	505	DISETTORE CORNEALE, SATO .....	373
CURETTA TAGLIANTE, BUSHE .....	256	DEBAKEY-BAHNSON PINZA ANEURISMA .....	506	DISETTORE CORNEALE, TOOK .....	373
CURETTA TAGLIANTE, DAUBENSPECK .....	255	DEBAKEY-DIETHRICH MINI PINZA BULLDOG .....	101	DISETTORE GORNEY .....	277
CURETTA TAGLIANTE, HALLE .....	253	DEBAKEY-MOSQUITO PINZA EMOSTATICA .....	509	DISETTORE PER SACCO LACRIMALE, LANG .....	378
CURETTA TAGLIANTE, JACOBSON .....	257	DEBAKEY-PEAN PINZA EMOSTATICA .....	513	DISETTORE PER TONSILLE, HURD .....	465
CURETTA TAGLIANTE, JANSEN .....	257	DEBAKEY-RANKIN PINZA EMOSTATICA .....	512	DISETTORE PER TONSILLE, LOPEZ-REINKE .....	465
CURETTA TAGLIANTE, LEMPERS .....	256	DEBAKEY-SATINSKY PINZA PER OCCLUSIONE .....	502	DISETTORE PER TONSILLE, YANKAUER .....	465
CURETTA TAGLIANTE, MARTINI .....	257	TANGENZIALE .....	502	DISETTORE, FISCH .....	420
CURETTA TAGLIANTE, SCHEDE .....	251	DEJERINE MARTELLO DA PERCUSSIONE .....	24	DISETTORE, PENFIELD .....	333
CURETTA TAGLIANTE, SCOVILLE .....	253	DELEE DIVARICATORE .....	574	DISTRIBUTORE PER PERFORATORI FILIFORME .....	310
CURETTA TAGLIANTE, SPINAL .....	253	DEMELE AGO PASSAFILI .....	315	DISTRIBUTORE PER SPAZZOLINI .....	611
CURETTA TAGLIANTE, SPRATT .....	251	DEMELE STRUMENTO TENDIFILI .....	315	DITTEL CANDELETTA DILATATRICE .....	554
CURETTA, FAULKNER .....	449	DENHART APRIBOCCA .....	454	DIVARICATORE .....	463/3
CURETTA, HOUSE .....	420	DENIS-BROWNE DIVARICATORE ADDOMINALE .....	185	DIVARICATORE ADDOMINALE BABY GOSSET .....	181
CURETTE UTERINI, BLAKE .....	595	DEPRESSORE PER EPIGLOTTIDE, REICHERT .....	471	DIVARICATORE ADDOMINALE BALFOUR .....	182
CURETTE UTERINI, BUMM .....	597	DEPRESSORE UTERINO, BRAUN .....	586	DIVARICATORE ADDOMINALE BALFOUR .....	183
CURETTE UTERINI, RECAMIER .....	597	DEPRESSORE UTERINO, SIMS .....	586	DIVARICATORE ADDOMINALE BALFOUR BODY .....	182
CURETTE UTERINI, SIMS .....	597, 598	DERF PORT'AGHI .....	208	DIVARICATORE ADDOMINALE BALFOUR-US .....	184
CURETTE UTERINI, THOMAS .....	599	DERMATOMO, HUMBY .....	50	DIVARICATORE ADDOMINALE CHARNELY .....	289
CUSCO SPECOLO VAGINALE .....	570, 571	DERMATOMO, SILVER .....	50	DIVARICATORE ADDOMINALE COLLIN .....	190
CUSHING (TAYLOR) PINZA TC .....	87	DERMATOMO, SCHINK .....	50	DIVARICATORE ADDOMINALE COLLIN-LOKITE .....	191
CUSHING DIVARICATORE .....	151	DERMATOMO, SCHINK .....	50	DIVARICATORE ADDOMINALE COMPLETO KIRSCHNER .....	187/1
CUSHING DIVARICATORE .....	152	DERRA PINZA CARDIOVASCOLARE ATRAUMATICA .....	415	DIVARICATORE ADDOMINALE DENIS-BROWNE .....	185
CUSHING DIVARICATORE .....	153	D'ERRICO UNCINO PER NERVI .....	329/2	DIVARICATORE ADDOMINALE FRAZIER .....	181
CUSHING PERFORATORE .....	299	DESCHAMPS AGO PER LEGATURE .....	218	DIVARICATORE ADDOMINALE GELPI .....	189/2
CUSHING PINZA ANATOMICA .....	83	DESJARDINS CUCCHIAIO PER CALCOLI BILIARI .....	534	DIVARICATORE ADDOMINALE GOSSET .....	181
CUSHING PINZA CHIRURGICA .....	83	DESJARDINS PINZA EMOSTATICA .....	121	DIVARICATORE ADDOMINALE HORGAN .....	183
CUSHING PINZA TAGLIANTE PER LAMINECTOMIA .....	340	DESJARDINS PINZA PER CALCOLI BILIARI .....	531	DIVARICATORE ADDOMINALE JACKSON BURROWS 189/2 .....	189/2
CUSHING SPATOLA CEREBRALE .....	369	DESJARDINS SONDA PER CALCOLI BILIARI .....	532	DIVARICATORE ADDOMINALE KIRSCHNER .....	185
CUSHING UNCINO PER NERVI .....	328	DESMARRES DIVARICATORE .....	151	DIVARICATORE ADDOMINALE KIRSCHNER .....	185
CUZZI CUCCHIAIO PER ABORTO .....	606	DESMARRES PINZA PER CALAZIO .....	393	DIVARICATORE ADDOMINALE RICARD .....	191
CZERNY PINZA PER ABBASSARE IL COLLO .....	584	DEUTSCHMANN COLTELLO PER CATARATTA .....	371	DIVARICATORE ADDOMINALE RIGBY .....	189/2
DELL'UTERO .....	584	DEVILBISS PINZA PER CRANIOTOMIA .....	332	DIVARICATORE ADDOMINALE ROCHARD .....	186
CZERNY SPECOLO RETTALE .....	559	DEVILBISS PINZA PER CRANIOTOMIA .....	332	DIVARICATORE ADDOMINALE, DE BAKEY .....	189/1
D .....		DIAPASON .....	404	DIVARICATORE ADDOMINALE, DOYEN .....	189/1
DANDY PINZA EMOSTATICA .....	109	DIAPASON, HARTMANN .....	403	DIVARICATORE ADDOMINALE, GELPI .....	189/1
DANDY UNCINO PER NERVI .....	328	DIAPASON, LUCAE .....	404	DIVARICATORE ADDOMINALE, SET COMPLETO, CON MORSETTI E VALVE .....	193
DARLING DIVARICATORE .....	178	DIAPASON, REDA .....	403	DIVARICATORE ADDOMINALE, SET COMPLETO, CON SISTEMA DI MONTAGGIO .....	192
DARTIGUES PINZA PER AFFERRARE L'UTERO .....	585	DIAPASON, RYDEL-SEIFFERT .....	404	DIVARICATORE ADSON .....	172
DASTOOR PINZA PER STRABISMO .....	386	DIAPASON, RYDEL-SEIFFERT .....	404	DIVARICATORE ADSON .....	174
DAUBENSPECK CURETTA TAGLIANTE .....	255	DIAPASON, RYDEL-SEIFFERT .....	404	DIVARICATORE ANALE, SMITH-BUIE .....	561
DAVIDSON(SCAPULA) DIVARICATORE .....	166	DIAPASON, RYDEL-SEIFFERT .....	404	DIVARICATORE AUFRANC-COBRA .....	289
DAVIEL CUCCHIAIO PER CATERATTA .....	377	DIAPASON, RYDEL-SEIFFERT .....	404	DIVARICATORE COLLIN .....	139
DAVIS AGO PER CORPI ESTRANEI .....	374	DIAPASON, RYDEL-SEIFFERT .....	404	DIVARICATORE COSTALE, COOLEY .....	487
DAVIS DURA DISSETTORE .....	332	DIAPASON, RYDEL-SEIFFERT .....	404	DIVARICATORE COSTALE, COOLEY-NEONATAL .....	485
DAVIS PINZA PER STERILIZZAZIONE .....	227	DIAPASON, RYDEL-SEIFFERT .....	404	DIVARICATORE COSTALE, DE BOER .....	486
DAVIS SPATOLA CEREBRALE .....	337	DIAPASON, RYDEL-SEIFFERT .....	404	DIVARICATORE COSTALE, FINOCHIETTO-BURFORD .....	483
DAVIS-BOYLE ABBASSALINGUA .....	455	DIAPASON, RYDEL-SEIFFERT .....	404	DIVARICATORE COSTALE, HAIGHT .....	487
DAVIS-BOYLE APRIBOCCA .....	455	DIAPASON, RYDEL-SEIFFERT .....	404	DIVARICATORE COSTALE, MORSE .....	484
DAVIS-MEYER APRIBOCCA .....	457	DIAPASON, RYDEL-SEIFFERT .....	404	DIVARICATORE COSTALE, MORSE-FAVALORO .....	484
DAY UNCINO .....	409	DIAPASON, RYDEL-SEIFFERT .....	404	DIVARICATORE COSTALE, RIENHOFF-FINOCHIETTO .....	486
DE BAKEY PINZE ATRAUMATICHE BULLDOG .....	103	DIAPASON, RYDEL-SEIFFERT .....	404	DIVARICATORE COSTALE, TUFFIER .....	487
DE BAKEY PINZE ATRAUMATICHE IN TITANIO .....	99	DIAPASON, RYDEL-SEIFFERT .....	404	DIVARICATORE CUSHING .....	152
DE BAKEY CANNULA D'ASPIRAZIONE .....	28	DIAPASON, RYDEL-SEIFFERT .....	404	DIVARICATORE CUSHING .....	153
DE BAKEY DILATATORE VASCOLARE .....	529	DIAPASON, RYDEL-SEIFFERT .....	404	DIVARICATORE DELEE .....	574
DE BAKEY DIVARICATORE ADDOMINALE .....	189/1	DIAPASON, RYDEL-SEIFFERT .....	404		

DIVARICATORE FINSEN .....	168	DIVARICATORE, COOLEY.....	148	DOYEN PINZA INTESTINALE .....	540
DIVARICATORE HARRINGTON-PEMBERTON .....	147	DIVARICATORE, CORYLLOS.....	166	DOYEN PINZA PER POLIPI UTERINI .....	585
DIVARICATORE KIRSCHNER.....	187	DIVARICATORE, CRILE.....	140	DOYEN SPECILLO SCANALATO .....	199
DIVARICATORE KOCHER .....	155	DIVARICATORE, CUSHING.....	151	DOYEN SPECILO VAGINALE .....	574
DIVARICATORE KOCHER .....	159	DIVARICATORE, DARLING.....	178	DOYEN TIRAMIOMI.....	594
DIVARICATORE KOCHER .....	160	DIVARICATORE, DAVIDSON (SCAPULA).....	166	DOYEN-BABY PINZA INTESTINALE .....	540
DIVARICATORE KOCHER .....	163	DIVARICATORE, DEAVER.....	145	DOYEN-JANSEN(MOLT) APRIBOCCA .....	454
DIVARICATORE KÖNIG .....	153	DIVARICATORE, DEAVER GRIP.....	146	DOYEN-JANSEN(MOLT) APRIBOCCA .....	454
DIVARICATORE LANGENBECK .....	158	DIVARICATORE, DESMARRRES .....	151	DOYEN-STILLE .....	167
DIVARICATORE LANGENBECK .....	159	DIVARICATORE, DINGMANN.....	463	DUBOIS FORBICI GINECOLOGICHE .....	63
DIVARICATORE MARTIN .....	175/1	DIVARICATORE, DOYEN .....	163	DUPLAY PINZA PER ABBASSARE IL COLLO	
DIVARICATORE MAYO-ADAMS .....	171	DIVARICATORE, DOYEN-STILLE .....	167	DELL'UTERO .....	582
DIVARICATORE MEYERDING .....	157	DIVARICATORE, FARABEUF .....	139	DUPLAY PINZA PER MEDICATURA .....	134
DIVARICATORE MEYERDING .....	177	DIVARICATORE, FRITSCH .....	163	DUPLEX STETOSCOPIO.....	23
DIVARICATORE MURPHY .....	156	DIVARICATORE, GI-L-VERNET .....	152	DUPUY-WEISS AGO PER TONSILLE .....	466
DIVARICATORE NORFOLK-NORDWICH .....	172	DIVARICATORE, GOELET .....	141	DURA DISSETTORE.....	332
DIVARICATORE OBWEGESER .....	460, 461	DIVARICATORE, GREEN.....	160	DURA DISSETTORE, DAVIS.....	332
DIVARICATORE PELVICO, ST.MARKS .....	165	DIVARICATORE, HARRINGTON.....	147	DURA DISSETTORE, FRAZIER .....	333
DIVARICATORE PER CHIRURGIA PLASTICA BREAST .....	198	DIVARICATORE, HEANEY .....	164	DURA DISSETTORE, HOEN .....	333
DIVARICATORE PER CHIRURGIA PLASTICA CORONAL		DIVARICATORE, HENLEY .....	170	DURA DISSETTORE, HORSLEY .....	333
BLOW .....	198	DIVARICATORE, HIBBS .....	164	DURA DISSETTORE, MILLIGAN .....	332
DIVARICATORE PER CHIRURGIA PLASTICA FERRIERA .....	197	DIVARICATORE, HOESSEL .....	167	DURA DISSETTORE, OLIVECRONA .....	332
DIVARICATORE PER CHIRURGIA PLASTICA FREEMAN .....	198	DIVARICATORE, HOFER .....	465	DURA DISSETTORE, SACHS .....	332
DIVARICATORE PER CHIRURGIA PLASTICA TEBBETTS .....	197	DIVARICATORE, HOLZHEIMER .....	168	DURA DISSETTORE, TOENNIS .....	332
DIVARICATORE PER CHIRURGIA PLASTICA		DIVARICATORE, ISRAEL .....	162	DURA DISSETTORE, WOODSON .....	333
YANCOSKIE .....	198	DIVARICATORE, JANSEN .....	168	DURANTE PINZA DA PRESA .....	88
DIVARICATORE PER CORPI VERTREBRALI, CLOWARD .....	339	DIVARICATORE, KELLY .....	164	DUVAL PINZA DA PRESA .....	85
DIVARICATORE PER CORPI VERTREBRALI, INGE .....	339	DIVARICATORE, KELLY GRIP .....	142	DUVAL PINZA PER AFFERRARE INTESTINI .....	539
DIVARICATORE PER GESSI REDA.....	232	DIVARICATORE, KOCHER-LANGENBECK.....	159		
DIVARICATORE PER GESSI, BEESON .....	232	DIVARICATORE, KOERTE .....	162		
DIVARICATORE PER GESSI, HAGLUND-STILLE .....	232	DIVARICATORE, LAHEY .....	157		
DIVARICATORE PER GESSI, HENNIG .....	232	DIVARICATORE, LITTLE .....	157		
DIVARICATORE PER GUANCE, STERNBERG .....	453	DIVARICATORE, LOVE .....	465		
DIVARICATORE PER LA PROSTATA, YOUNG.....	550	DIVARICATORE, MATHIEU .....	141		
DIVARICATORE PER LABBRA .....	453	DIVARICATORE, MEYERDING .....	180		
DIVARICATORE PER LAMINECTOMIA SCOVILLE .....	196	DIVARICATORE, MITTELDOERFF .....	160		
DIVARICATORE PER LAMINECTOMIA		DIVARICATORE, MIKULIC .....	163		
SCOVILLE-HAVERFIELD .....	196	DIVARICATORE, MOLLISON .....	171		
DIVARICATORE PER LAMINECTOMIA, CHERRY.....	488	DIVARICATORE, MORRIS .....	164		
DIVARICATORE PER SPINA CERVICALE CASPAR .....	179	DIVARICATORE, NAGER .....	465		
DIVARICATORE PER SPINA CERVICALE CASPAR .....	180	DIVARICATORE, OLLIER .....	162		
DIVARICATORE PER TIROIDE, SCHOENBORN .....	479	DIVARICATORE, PARKER .....	139		
DIVARICATORE PER TORACE, MERCEDES .....	489	DIVARICATORE, PLESTER .....	171		
DIVARICATORE PERKINS .....	168	DIVARICATORE, RAGNELL .....	140		
DIVARICATORE ROSE .....	140	DIVARICATORE, RAMUS .....	461		
DIVARICATORE SAUERBRUCH.....	164	DIVARICATORE, RICHARDSON.....	142		
DIVARICATORE SAUERBRUCH.....	166	DIVARICATORE, RICHARDSON GRIP .....	142		
DIVARICATORE SCALP-CONTOUR .....	169	DIVARICATORE, RICHARDSON-EASTMAN .....	142		
DIVARICATORE SPINALE, TAYLOR.....	291	DIVARICATORE, ROUX .....	139		
DIVARICATORE STRANDELL-STILLE .....	157	DIVARICATORE, ROUX-BABY .....	140		
DIVARICATORE TESSIER .....	463/3	DIVARICATORE, ROUX-MINI .....	140		
DIVARICATORE TRACHEALE .....	476	DIVARICATORE, SENN-GREEN .....	153		
DIVARICATORE TRACHEALE, ITERSON .....	477	DIVARICATORE, SENN-MILLER .....	143		
DIVARICATORE TRACHEALE, JACKSON.....	476	DIVARICATORE, SIMON .....	164		
DIVARICATORE TRACHEALE, NEWS .....	477	DIVARICATORE, SPINA-NASALIS .....	461		
DIVARICATORE TRAVERS .....	172	DIVARICATORE, VOLKMANN .....	153		
DIVARICATORE TUFFIER .....	147	DIVARICATORE, VOLKMANN .....	154		
DIVARICATORE VESCICALE, LEGUE .....	553	DIVARICATORE, WEITLANER .....	169		
DIVARICATORE VESCICALE, MILLIN .....	552	DIVARICATORE, WEITLANER-WULLSTEIN .....	169		
DIVARICATORE VESCICALE, MILLIN .....	553	DIVARICATORE, ZENKER .....	161		
DIVARICATORE VESCICALE, THOMSON-WALKER.....	552	DIVARICATORE,US-ARMY PARKER-LANG.....	141		
DIVARICATORE VESCICALE, JUDD-MASSON .....	552	DIVISORE PER CRANIO .....	267		
DIVARICATORE VOLKMANN .....	156	DIX SGORBIA PER CORPI ESTRANEI .....	374		
DIVARICATORE WULLSTEIN .....	171	DIX STRUMENTI PER CORPI ESTRANEI .....	380		
DIVARICATORE, ADSON .....	173	DOUGHTY ABBASSALINGUA .....	458		
DIVARICATORE, ALM .....	168	DOUGLAS COLTELLO PER TONSILLE .....	466		
DIVARICATORE, ANDERSON-ADSON.....	172	DOUGLAS PINZA DEPILATORIA .....	395		
DIVARICATORE, BECKMANN .....	176	DOYEN DIVARICATORE .....	163		
DIVARICATORE, BECKMANN-ADSON .....	175	DOYEN DIVARICATORE ADDOMINALE .....	189/1		
DIVARICATORE, BECKMANN-EATON .....	176	DOYEN FORBICI GINECOLOGICHE .....	63		
DIVARICATORE, BRUNNER .....	167	DOYEN PERIOSTOTOMO .....	278		
DIVARICATORE, CLOWARD .....	178	DOYEN PERIOSTOTOMO .....	278		
DIVARICATORE, COLLIN HARTMANN .....	141	DOYEN PINZA FISSATELI .....	133		

ELEVATORE QUERVAIN.....	275	FISCH UNCINO.....	335	FORBICI PER DISSEZIONE, LEXER.....	53
ELEVATORE SEBILÉAU.....	275	FISCH DISSETTORE.....	420	FORBICI PER DISSEZIONE, LEXER-BABY.....	53
ELEVATORE, ALDERDYCE.....	282	FISCHER PINZA PER IRIDE.....	384	FORBICI PER DISSEZIONE, LEXER-BABY TC.....	53
ELEVATORE, BOIES.....	277	FISH SPECILLO.....	199	FORBICI PER DISSEZIONE, MAYO-NOBLE.....	52
ELEVATORE, CREGO.....	282	FISHER COLTELLO PER TONSILLE.....	466	FORBICI PER DISSEZIONE, METZENBAUM.....	53/1
ELEVATORE, FREER.....	434	FOERSTER PINZA PER IRIDE.....	383	FORBICI PER DISSEZIONE, METZENBAUM FINO.....	53/1
ELEVATORE, KEY.....	282	FOERSTER PINZA PER MEDICATURA.....	136	FORBICI PER DISSEZIONE, METZENBAUM TC.....	53/1
ELEVATORE, LEMPÉRT.....	420	FOMON FORBICI NASALI.....	58	FORBICI PER DISSEZIONE, TOENNIS-ADSON.....	65
ELEVATORE, MCDONALD,19CM.....	283	FOMON FORBICI PER RINOPLASTICA.....	65/1	FORBICI PER DISSEZIONE, WELLER.....	53/2
ELEVATORE, MURPHY-LANE.....	283	FOMON PERIOSTOTOMO.....	277	FORBICI PER DISSEZIONE,METZENBAUM FINO TC.....	53/1
ELEVATORE, SAYRE.....	281	FOMON RASPA NASALE.....	444	FORBICI PER DURAMADRE, SCHMIEDEN-TAYLOR.....	65/1
ELEVATORE, WATSON-CHEYNE.....	283	FOMON SCALPELLO PER SETTO.....	441	FORBICI PER ENTEROTOMIA.....	66
ELLIOT FORCIPE.....	602	FOMON TC RASPA NASALE.....	445	FORBICI PER EPISIOTOMIA, BRAUN-STADLER.....	64
ELLIS SGORBIA PER CORPI ESTRANEI.....	374	FOMON UNCINO PER LA PELLE.....	447/1	FORBICI PER EPISIOTOMIA, WALDMANN.....	64
ELSCHING DISSETTORE CORNEALE.....	373	FORBICE PER IL SETTO NASALE, KILLIAN.....	471	FORBICI PER FILO DI METALLO E LAMIERA, UNIVERSAL.....	67
ELSCHING SPATOLA PER CICLODIALISI.....	379	FORBICE PER LE UNGHIE.....	609	FORBICI PER INCISIONE.....	52
ELSCHNIG PINZA CAPSULARE.....	391	FORBICE PER PELLE.....	610	FORBICI PER ISTERECTOMIA, WERTHEIM.....	63
ELSCHNIG PINZA FISSATRICE.....	389	FORBICI BULLDOG COTTLE.....	56	FORBICI PER LEGATURE, HEATH.....	66
EMMETT UNCINO PER FISTOLE.....	594	FORBICI CORNEALI, CASTROVIEJO.....	79	FORBICI PER LEGATURE, LITTAUER.....	66
ENDOSPECOLO KOGAN.....	577	FORBICI GINECOLOGICHE, DOYEN.....	63	FORBICI PER LEGATURE, NORTHBENT.....	66
ENGEL SEGA PER GESSI.....	229	FORBICI GINECOLOGICHE, DUBOIS.....	63	FORBICI PER LEGATURE, SPENCER.....	66
ENUCLEATORE PER TENDINI, BRAND.....	294	FORBICI GINECOLOGICHE, SIEBOLD.....	62	FORBICI PER NEUROCHIRURGIA.....	65
ENUCLEATORE PER TENDINI, BUNELL.....	292	FORBICI GINECOLOGICHE, SIMS.....	62	FORBICI PER NEUROCHIRURGIA, STRULLY.....	65
EPKER OSTEOTOMI.....	464/2	FORBICI GINGIVALI, GOLDMAN-FOX.....	67	FORBICI PER OFTALMOLOGIA.....	57
EPPENDORFFER PINZA PER BIOPSIA.....	590	FORBICI GINGIVALI, LA GRANGE.....	69	FORBICI PER OFTALMOLOGIA GRADLE.....	57
ERRICO PERFORATORE.....	299	FORBICI GINGIVALI, LOCKLIN.....	69	FORBICI PER OFTALMOLOGIA, AEBLI.....	58
ESMARCH BENDA PER COMPRESSIONE.....	297	FORBICI GINGIVALI, QUINBY.....	67	FORBICI PER OFTALMOLOGIA, STEVENS.....	58
ESMARCH COLTELLO PER GESSI.....	233	FORBICI GRAEFE.....	56	FORBICI PER PARAMETRIO.....	63
ESMARCH FORBICI PER BENDAGGI.....	69/2	FORBICI NASALI.....	429	FORBICI PER RINOPLASTICA FOMON.....	65/1
ESTENSIONE DELL'ARTICOLAZIONE.....	188	FORBICI NASALI, COTTLE.....	59	FORBICI PER STERNO SCHUMACHER.....	481
ESTRATTATORE, KUENTSCHER.....	322	FORBICI NASALI, FOMON.....	58	FORBICI PER STRABISMO.....	58
ETHICON PINZA APPLICATORE CLIPS.....	524, 525	FORBICI NASALI, HEYMANN.....	58	FORBICI PER STRABISMO.....	58
EYES SERRANODI PER TONSILLE.....	468	FORBICI OCULISTICHE WESTCOTT.....	75	FORBICI PER TONSILLE.....	59
EXACTA SFGMOMANOMETRO.....	8	FORBICI OCULISTICHE, BARRAQUER.....	75	FORBICI PER TONSILLE, BOETTCHER.....	59
F					
FACE LIFT FORBICI FREEMAN.....	74	FORBICI OCULISTICHE, NOYES.....	75	FORBICI PER TONSILLE, DEAN.....	59
FACE LIFT FORBICI GORNEY.....	73	FORBICI OCULISTICHE, VANNAS.....	79	FORBICI PER TONSILLE, GOOD.....	59
FACE LIFT FORBICI KAYE.....	73	FORBICI OCULISTICHE, WECKER.....	75	FORBICI PER TONSILLE, PRINCE.....	59
FACE LIFT FORBICI REES.....	73	FORBICI PER BENDAGGI.....	70	FORBICI POLMONARE, CRAFTFOORD.....	65/2
FANSLER PROCTOSCOPIO.....	565	FORBICI PER BENDAGGI, BERGMANN.....	69/1	FORBICI TORACALI, THOREK.....	65/2
FARABEUFF DIVARICATORE.....	139	FORBICI PER BENDAGGI, BRUNS.....	70	FORBICI VASCOLARI DEBAKEY TC.....	60
FARABEUFF PERIOSTOTOMO.....	274	FORBICI PER BENDAGGI, ESMARCH.....	69/2	FORBICI VASCOLARI, DE BAKEY.....	61
FARABEUFF TENAGLIA PER OSSA.....	243	FORBICI PER BENDAGGI, KNOWLES.....	70	FORBICI VASCOLARI, DIETRICH.....	60
FARABEUFF-COLLIN PERIOSTOTOMO.....	274	FORBICI PER BENDAGGI, LISTER.....	69/1	FORBICI VASCOLARI, FAVALORO.....	61
FARABEUFF-LAMBOTTE TENAGLIA PER OSSA.....	243	FORBICI PER BENDAGGI, LORENZ.....	70	FORBICI VASCOLARI, KELLY.....	61
FARRELL PORTACOTONE.....	203	FORBICI PER BENDAGGI, REDA EXCENTER.....	69/2	FORBICI VASCOLARI, KLINKENBERG-LOTH.....	65/2
FAULKNER CURETTA.....	449	FORBICI PER BENDAGGI, SEUTIN.....	69/2	FORBICI VASCOLARI, POTTS-DE MARTEL.....	59
FAURE PINZA PER BIOPSIA.....	588	FORBICI PER BENDAGGI, SMITH US ARMY.....	69/1	FORBICI VASCOLARI, POTTS-SMITH.....	61
FAURE PINZA PERITONEALE.....	123	FORBICI PER BENDAGGI, UNIVERSAL.....	70	FORBICI VASCOLARI, SATINSKY.....	65/2
FAVALORO FORBICI VASCOLARI.....	61	FORBICI PER CAPSULA, RESANO.....	53/2	FORBICI WAGNER.....	67
FEHLAND PINZA INTESTINALE.....	542	FORBICI PER CARTILAGINE, MARTIN.....	65/1	FORCIPE, BARTON.....	603
FEILCHENFELD PINZA PER SCHEGGE.....	91	FORBICI PER CARTILAGINE, MCINDOE.....	65/1	FORCIPE, BOERMA.....	604
FELDHEIM PINZA PER OSSA.....	249	FORBICI PER CHIRURGIA FINE, IRIS.....	54	FORCIPE, DE LEE.....	602
FERGUSSON CUCCHIAIO PER CALCOLI BILIARI.....	533	FORBICI PER CHIRURGIA FINE, JOSEPH.....	54	FORCIPE, ELLIOT.....	602
FERGUSSON FORBICI PER CHIRURGIA.....	66	FORBICI PER CHIRURGIA FINE, KILNER.....	54	FORCIPE, KIELLAND.....	602
FERGUSSON FRAZIER CANNULA D'ASPIRAZIONE.....	337	FORBICI PER CHIRURGIA FINE, REYNOLDS.....	54	FORCIPE, KIELLAND-LUIKART.....	603
FERGUSSON PINZA EMORROIDALE.....	109	FORBICI PER CHIRURGIA FINE, SAVENERO.....	54	FORCIPE, LUIKART.....	603
FERGUSSON TENAGLIA PER OSSA.....	243	FORBICI PER CHIRURGIA STANDARD.....	51	FORCIPE, MCLEAN.....	603
FERRIERA DIVARICATORE PER CHIRURGIA PLASTICA.....	197	FORBICI PER CHIRURGIA, FERGUSSON.....	66	FORCIPE, MCLEAN-LUIKART.....	603
FERRIS-SMITH PINZA CHIRURGICA.....	84	FORBICI PER CHIRURGIA, METZENBAUM.....	54	FORCIPE, MCLEAN-TUCKER.....	603
FERRIS-SMITH PINZA TAGLIANTE PER LAMINECTOMIA.....	343	FORBICI PER CHIRURGIA, SYSTRUNK.....	66	FORCIPE, MCLEAN-TUCKER-LUIKART.....	603
FERRIS-SMITH-KERRISON PINZA TAGLIANTE PER DISCHI INTERVERTEBRALI.....	344, 344/2	FORBICI PER CORDA OMBELICALE, BUSCH.....	64	FORCIPE, NAEGELE.....	602
FICHOCHIETTO-BABY DIVARICATORE COSTALE.....	482	FORBICI PER CORDA OMBELICALE, MOD.USA.....	64	FORCIPE, PIPER.....	604
FILO PER OSSA.....	314	FORBICI PER CORDA OMBELICALE, SCHUMACHER.....	64	FORCIPE, SIMPSON.....	602
FINOCCHIETTO DIVARICATORE COSTALE.....	482, 484	FORBICI PER CORONA, BEEBEE.....	68	FORCIPE, SIMPSON-BRAUN.....	602
FINOCCHIETTO PINZA PER BRONCHI.....	490	FORBICI PER DISSEZIONE.....	52	FORCIPE, SIMPSON-LUIKART.....	603
FINOCCHIETTO DIVARICATORE COSTALE.....	484	FORBICI PER DISSEZIONE DEAYER.....	52	FORCIPE, WRIGLEY.....	602
FINOCCHIETTO PORT'AGHI.....	211	FORBICI PER DISSEZIONE MAYO.....	52	FOREGGER LARINGSOCOPIO.....	29
FINOCCHIETTO-BURFORD DIVARICATORE COSTALE.....	483	FORBICI PER DISSEZIONE MAYO, TC.....	52	FOREGGER LARINGSOCOPIO SET.....	31
FINSEN DIVARICATORE.....	168	FORBICI PER DISSEZIONE MAYO-STILLE.....	52	FOX CURETTA PER LUPUS.....	608
		FORBICI PER DISSEZIONE MAYO-STILLE, TC.....	52	FRAENKEL INSERTO.....	472
		FORBICI PER DISSEZIONE METZENBAUM.....	53/1	FRAENKEL PINZA PER POLIPI LARINGEI.....	471
		FORBICI PER DISSEZIONE, JORGENSEN.....	53	FRANCIS AGO PER CORPI ESTRANEI.....	374

FRANKLIN-SILVERMANN AGO PER BIOPSIA .....	206	GRAFFA PER IL CUIO CAPELLUTO, RANEY .....	327	HEIFETZ SPATOLA CEREBRALE .....	369
FRAZIER DIVARICATORE ADDOMINALE .....	181	GRAHAM UNCINO PER NERVI .....	329	HEIMING PINZA PER CALCOLI RENALI .....	536
FRAZIER DURA DISSETTORE .....	333	GRAIG PINZA NASALE .....	426	HEISS PINZA EMOSTATICA .....	112
FRAZIER UNCINO PER LA PELLE .....	149	GRAVE SPECOLO VAGINALE .....	570	HEISTER APRIBOCCA .....	454
FREEMAN DIVARICATORE PER CHIRURGIA PLASTICA .....	198	GRAY PINZA EMOSTATICA .....	121	HENKE ELEVATORE PER TONSILLE .....	465
FREEMAN FACE LIFT FORBICI .....	74	GREEN DISSETTORE CORNEALE .....	374	HENLEY DIVARICATORE .....	170
FREER COLTELLO PER SETTO NASALE .....	434	GREEN DIVARICATORE .....	160	HENNIG DIVARICATORE PER GESSI .....	232
FREER ELEVATORE .....	434	GREEN PINZA FISSATRICE .....	390	HEPP-SCHIEDL MICRO FORBICI .....	78
FREER ELEVATORE PER SETTO .....	437	GREEN UNCINO PER IL STRABISMO .....	375	HERRICK PINZA PER PUNCONJO RENALE .....	123
FREER SCALPELLO PER SETTO .....	.....	GREEN-ARMYTAGE PINZA UTERINA PER EMOSTASI .....	605	HESS PINZA CAPSULARE .....	391
FREER UNCINO PER LA PELLE .....	448	GREGORY PINZA CARDIOVASCOLARE ATRAUMATICA .....	517	HESS PINZA PER IRIDE .....	384
FRENZEL ABBASSALINGUA .....	451	GREVEN MIKRO-PINZA AURICOLARE .....	414	HESS UNCION PER NERVI .....	329/1
FRENZEL OCCHIALI NISTAGMO .....	20	GROSS CUCCHIAIO AURICOLARE .....	409	HEYMANN PINZA PER SETTO NASALE .....	425
FRIEDMANN MINI PINZA SGORBIA .....	234	GROSS-MAIER PINZA PER MEDICATURA .....	134	HEYMANN FORBICI NASALI .....	58
FRIEDMANN SPECOLO VAGINALE .....	577	GRUBER SPECOLO AURICOLARE .....	399	HEYMANN-KNIGHT PINZA AURICOLARE .....	425
FRITSCH DIVARICATORE .....	163	GUAINA PER VITI .....	325	HEYWOOD-SMITH PINZA PER EMORROIDI .....	567
FRYKHOLM PINZA SGORBIA .....	240	GUIDA CONDUTTRICE .....	321	HIBBS OSTEOTOMO .....	265
FUCHS PINZA CAPSULARE .....	391	GUIDA TENDINI, BUNELL .....	294	HIBBS DIVARICATORE .....	164
FUCHSIG PINZA EMOSTATICA .....	113	GUILLEN CANNULA PER ASPIRAZIONE .....	433/1	HIBBS SCALPELLO .....	265
<b>G</b>					
GALLAHER RASPA NASALE .....	446	GUTHRIE UNCINO PER LA PELLE .....	149	HIBBS SGORBIA .....	265
GASS UNCINO .....	376	GUYON CANDELETTA DILATRICE .....	554	HILL-FERGUSON SPECOLO RETTALE .....	560
GAUSS PINZA PER IL CUIO CAPELLUTO .....	605	GUYON INTRODUTTORE PER CATETERI .....	554	HIRSCHMAN SPATOLA PER CICLODIALISI .....	379
GELPI DIVARICATORE ADDOMINALE .....	189/1	GUYON PINZA EMOSTATICA .....	122	HIRSCHMANN ANOSCOPO .....	562
GELPI DIVARICATORE ADDOMINALE .....	189/2	GUYON PINZA RENALE .....	122	HOEN DURA DISSETTORE .....	333
GEMINI PINZA EMOSTATICA .....	115	GUYTON-LUNDSGAARD SCLEROTOMO .....	373	HOESEL PORT'AGHI .....	213
GERALD PINZA ANATOMICA .....	86	<b>H</b>			
GERALD PINZA CHIRURGICA .....	87	HABERER SPATOLA ADDOMINALE E INTESTINALE .....	143/1	HOESEL PORT'AGHI .....	213
GERSTER PINZA PER OSSA .....	250	HAGLUND-STILLE DIVARICATORE PER GESSI .....	232	HOFER DIVARICATORE .....	465
GERZOG MARTELLO .....	270	HAIGHT DIVARICATORE COSTALE .....	487	HOFFMANN PINZA SERRATUBI .....	624
GHIGLIOTTINA PER TAGLIARE FILI 32CM .....	320	HAJEK MARTELLO .....	273	HOHMANN MINI ELEVATORE PER OSSA .....	286
GHIERTZ-STILLE COSTOTOMO .....	481	HAJEK SCALPELLO PER SETTO .....	442/1	HOLINGER LARINGOSCOPIO PER OPERAZIONE .....	37
GIGLI SEGA .....	332	HAJEK-BALLENGER ELEVATORE PER SETTO .....	439	HOLLINGER PORTATORE DI LUCE .....	37
GILL DISSETTORE CORNEALE .....	373	HAJEK-KOFLER PINZA SFENOIDALE .....	430, 431	HOLSHER UNCINO PER RADICI DEI NERVI .....	329/1
GILL PINZA PER IRIDE .....	384	HALLE CURETTA TAGLIANTE .....	253	HOLTZ PINZA TAGLIANTE PER CAPSULA .....	380
GILL-ARRUGA PINZA CAPSULARE .....	390	HALLE ELEVATORE PER SETTO .....	437	HOLZBACH PINZA PER ISTERECTOMIA .....	126
GILL-HESS PINZA PER IRIDE .....	384	HALSEY PORT'AGHI .....	208	HOLZBACH PINZA PER ISTERECTOMIA .....	126
GILLIES PINZA CHIRURGICA .....	86	HALSTED-MOSQUITO PINZA EMOSTATICA .....	105	HOLZHEIMER DIVARICATORE .....	168
GILLIES PORT'AGHI .....	212	HANK DILATATORE UTERINO .....	580	HOPKINS COLTELLO PER GESSI .....	233
GILLIES UNCINO PER LA PELLE .....	448	HARGIS ELEVATORE PER PERIOSTIO .....	463/2	HORGAN DIVARICATORE ADDOMINALE .....	183
GIL-VERNET DIVARICATORE .....	152	HARGIS SEPERATORE PER IL CORPO .....	.....	HORIZON PINZA APPLICATORE CLIPS .....	524, 525
GIUNTO DI PROLUNGAMENTO .....	299	MANDIBOLARE .....	463/6	HORSLEY DURA DISSETTORE .....	333
GLOVER BULLDOG PINZA ATRAUMATICA .....	100	HARKEN PINZA AURICOLA .....	503	HÖSEL DIVARICATORE .....	167
GLOVER BULLDOG PINZA ATRAUMATICA .....	103	HARMS, SONDA .....	381	HOUSE CANNULA D'ASPIRAZIONE .....	337/2
GLOVER PINZA VASCOLARE .....	515	HARRINGTON DIVARICATORE .....	147	HOUSE CURETTA .....	420
GLUCK COSTOTOMO .....	480	HARRINGTON PINZA PER BRONCHI .....	490	HOWARTH ELEVATORE PER SETTO .....	438
GOELET DIVARICATORE .....	141	HARRINGTON-PEMBERTON DIVARICATORE .....	147	HUBER MANICO UNIVERSALE .....	472
GOLDMANN-FOX FORBICI GINGIVALI .....	67	HARTMANN ABBASSALINGUA .....	452	HUDSON MANICO A T .....	300
GOMEL MICRO FORBICI .....	80	HARTMANN CANNULA PER IRRIGAZIONE .....	433	HUDSON PERFORATORE A MANO .....	299
GOMEL MICROPINZA CHIRURGICA .....	96	HARTMANN CATETERE AURICOLARE .....	408	HULKA PINZA PER ABBASSARE IL COLLO .....	.....
GONIOMETRO PER LE DITA .....	25	HARTMANN DIAPASON .....	403	DELL'UTERO .....	583
GONIOMETRO, MOELGTEN .....	25	HARTMANN PINZA PER CORPI ESTRANEI .....	412	HUMBY DERMATOMO .....	50
GOOD FORBICI PER TONSILLE .....	59	HARTMANN PINZA EMOSTATICA .....	104	HUNTER PINZA PER SCHEGGE .....	91
GOODELL DILATATORE UTERINO .....	581	HARTMANN PINZA PER POLIPI .....	424	HURD DISSETTORE PER TONSILLE .....	465
GORNEY DISSETTORE .....	277	HARTMANN SPECOLO AURICOLARE .....	399	<b>I</b>	
GORNEY FACE LIFT FORBICI .....	73	HARTMANN SPECOLO NASALE .....	422	I.U.D. PINZA DA PRESA FLESSIBILE, SERPENTINE .....	593
GOSSET DIVARICATORE ADDOMINALE .....	181	HARTMANN-HOFFMANN PINZA PER CORPI .....	421	I.U.D. UNCINO ESTRATTORE .....	593
GOURDET CUCCHIAIO UTERINO .....	599	ESTRANEI .....	412	IMPATTATORE .....	322
GRADLE FORBICI PER OFTALMOLOGIA .....	57	HARTMANN-WULLSTEIN PINZA PER CORPI .....	.....	IMPATTATORE / ESTRATTORE .....	322
GRADLE PINZA DEPILETORIA .....	395	ESTRANEI .....	412	IMPATTATORE FINALE, KUENTSCHER .....	321
GRAEFE BLEFAROSTATO .....	370	HARTMANN-HOFFMANN PINZA PER CORPI .....	412	INGE DIVARICATORE PER CORPI VERTTEBRALI .....	339
GRAEFE CISTOTOMO .....	375	HAUGH MIKRO-PINZA AURICOLARE .....	414	INSERTO, BARACANI .....	472
GRAEFE COLTELLO LANCEOLARE .....	372	HAYES PINZA PER ANASTOMOSI DEL RETTO .....	545	INSERTO, BRUENINGS .....	472
GRAEFE COLTELLO LANCEOLARE .....	372	HEANEY PINZA PER ISTERECTOMIA .....	126	INSERTO, CORDES .....	472
GRAEFE COLTELLO PER CATARATTA .....	371	HEANEY PORT'AGHI .....	210	INSERTO, FRAENKEL .....	472
GRAEFE CUCCHIAIO PER CATERATTA .....	377	HEANY CURETTA PER BIOPSIA .....	587	INSERTO, FRAENKEL .....	472
GRAEFE FORBICI .....	56	HEANY DIVARICATORE .....	164	INSERTO, KRAUSE .....	472
GRAEFE PINZA DA PRESA .....	83	HEANY-BALLENTINE PINZA PER ISTERECTOMIA .....	127	INSERTO, LANGE .....	472
GRAEFE PINZA FISSATRICE .....	389	HEATH FORBICI PER LEGATURE .....	66	INSERTO, SCHEINMANN .....	472
GRAEFE PINZA PER IRIDE .....	382	HEATH MARTELLO .....	273	INSERTO, SCHUMACHER .....	472
GRAEFE UNCINO .....	149	HEBRA CURETTA DA CALAZIO .....	377	INSERTO, SEIFERT .....	472
GRAEFE UNCINO PER IL STRABISMO .....	375	HEGAR DILATATORE UTERINO .....	578, 579	INSOFFIATORE D'ARIA, POLITZER .....	406
		HEGENBARTH PINZA PER AGRAFES .....	224	INSOFFIATORE PER POLVERE, KABIERSKE .....	405
				INSTRU-CARE OLIO PER STRUMENTI .....	634

INTRODUTTORE PER CATETERI GUYON .....	554	KEINSASSER LARINGOSCOPIO PER OPERAZIONE .....	35	KOGAN ENDOSPECOLO .....	577
IOWA AGO DI GUIDA .....	206	KEITH AGO .....	223	KÖNIG DIVARICATORE .....	153
IOWA PINZA PER ABBASSARE IL COLLO DELL'UTERO .....	584	KELLY DIVARICATORE .....	164	KÖNIG ELEVATORE PER OSSA .....	284
IRIS FORBICI .....	54	KELLY FORBICI VASCOLARI .....	61	KÖNIG PERIOTOTOMO .....	276
IRIS FORBICI, KNAPP .....	55	KELLY GRIP DIVARICATORE .....	142	KÖNIG SPECILLO DI GUIDA SCANALATO .....	221
IRIS FORBICI, LITTLER .....	55	KELLY PINZA EMOSTATICA .....	106	KOOS COLTELLO PER DURA MADRE .....	335
IRIS SUPERCUT FORBICI .....	72	KELLY PINZA PER POLIPI UTERINI .....	585	KÖRTE SPATOLA ADDOMINALE ED INTESTINALE .....	143/1
ISRAEL DIVARICATORE .....	162	KELLY PROCTOSCOPO .....	562, 563	KRAUSE INSERTO .....	472
ISTEROMETRO VALLEIX .....	586	KELLY-RANKIN PINZA EMOSTATICA .....	106	KRAUSE SERRANODI .....	411
ISTEROMETRO, COLLIN .....	586	KERN TENAGLIA PER OSSA .....	244	KRAUSE SERRANODI .....	433/2
ISTEROMETRO, MARTIN .....	586	KERRISON PINZA TAGLIENTE NASALE .....	428	KRAUSE-VOSS SERRANODI .....	433/2
ISTEROMETRO, SIMS .....	586	KEVORKIAN CURETTA PER BIOPSIA .....	587	KRAYENBÜHL UNCINO PER NERVI .....	336
ITERSON DIVARICATORE TRACHEALE .....	477	KEVORKIAN PINZA PER BIOPSIA .....	589	KRISTELLER SPECOLO VAGINALE .....	572
IVES-FANSLER ANOSCOPIO .....	562, 563	KEVORKIAN-PACIFIC PINZA PER BIOPSIA .....	592	KROENIG ABBASSALINGUA .....	451
IWANSON COMPASSO .....	624	KEY ELEVATORE .....	282	KRONECKER AGO PER LEGATURE .....	219
<b>J</b>					
JACKSON BURROWS DIVARICATORE ADDOMINALE ...	189/2	KEYES TREFINA CUTANEA .....	608	KUGLEN UNCINO .....	376
JACKSON DIVARICATORE TRACHEALE .....	476	KIELLAND FORCIPE .....	602	KUHNT RASCHIATOIO CORNEALE .....	373
JACKSON LARINGOSCOPIO PER OPERAZIONE .....	37	KIELLAND-LUIKART FORCIPE .....	603	KÜMMEL SPATOLA ADDOMINALE .....	144
JACKSON PINZA PER AFFERRARE TENDINI DA PRESA .....	292	KILLIAN PER IRRIGAZIONE .....	433, 433/1	KÜMMEL SPATOLA ADDOMINALE E INTESTINALE .....	143/2
JACKSON PINZA PER POLIPI LARINGEI .....	471	KILLIAN CANNULA PER IRRIGAZIONE .....	433, 433/1	KÜNTSCHER ALESATORE PER FEMORE .....	321
JACKSON SPECOLO VAGINALE .....	573	KILLIAN FORBICE PER IL SETTO NASALE .....	471	KÜNTSCHER ALESATORE PER L'APERTURA DEL MIDOLLO .....	321
JACOBS PINZA PER ABBASSARE IL COLLO DELL'UTERO .....	583	KILLIAN SGORBIA .....	442/1	KÜNTSCHER ESTRATTATORE .....	322
JACOBSON CURETTA TAGLIENTE .....	257	KILLIAN SPECOLO NASALE .....	423	KÜNTSCHER IMPATTATORE FINALE .....	321
JACOBSON PINZA EMOSTATICA .....	105	KILLIAN-CLAUS SGORBIA PER SETTO .....	442/1	<b>L</b>	
JACOBSON PORT'AGHI .....	215	KILNER FORBICI PER CHIRURGIA .....	54	LA FORCE AGO PER CORPI ESTRANEI .....	374
JACOBSON SONDA BOTTUNUTA .....	335	KILNER PORT'AGHI .....	212	LA FORCE COLTELLO ADENOIDE .....	450
JACOBSON UNCINO PER DURA MADRE .....	335	KILNER SUPERCUT FORBICI .....	72	LA GRANGE FORBICI GINGIVALI .....	69
JAEGER COLTELLO LANCEOLARE .....	372	KILNER UNCINO NASALE .....	447/1	LABORDE DILATATORE TRACHEALE .....	476
JAEGER PLACCA PER PALPEBRE .....	371	KILNER UNCINO PER LA PELLE .....	608	LACRIMAL CANNULA OCULISTICA .....	394
JAMESON PINZA PER STRABISMO .....	385	KILNER-DOUGHTY APRIBOCCA .....	456	LAHEY DIVARICATORE .....	157
JAMESON UNCINO PER IL STRABISMO .....	375	KIRBY-ARTHUR PINZA PER IRIDE .....	385	LAHEY PINZA EMOSTATICA .....	119/2
JANSEN CURETTA TAGLIENTE .....	257	KIRK MARTELLO .....	270	LAHEY PINZA PER GOZZO .....	479
JANSEN DIVARICATORE .....	168	KIRSCHNER ARCO PER ESTENSIONE .....	312	LAHEY UNCINO ACUTO .....	149
JANSEN PINZA AURICOLARE .....	424	KIRSCHNER DIVARICATORE ADDOMINALE .....	185	LAMA DI RASOIO .....	45
JANSEN PINZA SGORBIA .....	237	KIRSCHNER DIVARICATORE ADDOMINALE .....	187	LAMA DI RICAMBIO .....	49
JARCHO PINZA PER ABBASSARE IL COLLO DELL'UTERO .....	583	KIRSCHNER DIVARICATORE ADDOMINALE COMPLETO .....	187/1	LAMA DI RICAMBIO, STERILE .....	50
JAVID PINZA PER CAROTIDE .....	511	KIRSCHNER PERFORATORE A MANO .....	299	LAMA PER OSTEOTOMI .....	266
JENNINGS APRIBOCCA .....	454	KIRSCHNER PERFORATORI FILIFORME .....	306, 307	LAMA PER SCALPELLI .....	266
JENSEN CANNULA OCULISTICA .....	394	KIRSCHNER SPECILLO DI GUIDA SCANALATO .....	221	LAMBERT PINZA PER CALAZIO .....	393
JOHNSON-HORNE PORTACOTONE .....	203	KIRSCHNER US ARCO PER ESTENSIONE .....	312	LAMBERT-KAY PINZA PER ANASTOMOSI .....	505
JOHNS-HOPKINS BULLDOG PINZA .....	104	KIRSCHNER TELAIO PIEGABILE .....	187	LAMBERT-LOWMAN PINZA PER OSSA .....	249
JOHNS-HOPKINS PINZA APPLICATRICE .....	104	KIT PER AUTOPSIA IN ASTUCCIO DI LEGNO .....	269	LAMBOTTE OSTEOTOMO .....	261
JOHNS-HOPKINS PINZA EMOSTATICA .....	121	KLAPP DIVARICATORE .....	150	LAMBOTTE TENAGLIA PER OSSA .....	244
JOHNSON PORT'AGHI .....	211	KLEINERT-KUTZ PINZA PER AFFERRARE TENDINI .....	294	LAME PER BISTURI, STERILI .....	42
JONES PINZA FISSATELI .....	132	KLEINERT-KUTZ PINZA SGORBIA .....	237	LAME PER BISTURI, STERILI .....	42
JORGENSEN FORBICI PER DISSEZIONE .....	53	KLEINERT-KUTZ UNCINO PER LA PELLE .....	149	LAMPADA FRONTALE, CLAR .....	22
JOSEPH (LEWIS) RASPA NASALE .....	443	KLEINSASSER BRACCIO PORTALARINGOSCOPIO STERNALE .....	36	LANCASTER BLEFAROSTATO .....	371
JOSEPH COLTELLO NASALE .....	434	KLEINSASSER CANNULA DA INIEZIONE .....	36	LANDAU SPECOLO VAGINALE .....	577
JOSEPH ELEVATORE PER SETTO .....	437	KLEINSASSER CANNULA D'ASPIRAZIONE .....	36	LANDOLT PINZA DA PRESA PER TUMORI .....	341
JOSEPH FORBICI PER CHIRURGIA .....	54	KLEINSASSER PORTATORE DI LUCE FREDDA A FIBRE DI VETRO .....	36	LANE CACCIAVITE .....	323, 324
JOSEPH PERIOTOTOMO .....	277	KLEINSCHMIDT PINZA PER APPENDICE .....	544	LANE ELEVATORE PER OSSA .....	290
JOSEPH RASPA NASALE .....	443	KLINKENBERGH-LOTH .....	65/2	LANE PIEGAPLACCHE .....	325
JOSEPH SEGA NASALE .....	446	KNAPP COLTELLO PER IRIDE .....	372	LANE PINZA CHIRURGICA .....	84
JOSEPH UNCINO PER LA PELLE .....	149	KNAPP CUCCHIAIO PER CATERATTA .....	378	LANE PINZA FISSATELI .....	133
JUDD-ALLIS PINZA PER AFFERRARE INTESTINI .....	538	KNAPP IRIS FORBICI .....	55	LANE PINZA PORTAPLACCHE .....	325
JUDD-MASSON DIVARICATORE VESCICALE .....	552	KNAPP UNCINO DIVARICATORE .....	375	LANE PINZA PORTAVITI .....	325
JUERS MIKRO-PINZA AURICOLARE .....	414	KNAPP-LUER PINZA PER TRACOMA .....	393	LANE PINZA STOMACALE .....	547
JURASZ PINZA PER POLIPI LARINGEI .....	471	KNIGHT PINZA PER SETTO NASALE .....	425	LANE TENAGLIA PER OSSA .....	244
<b>K</b>					
KABIERSKE INSOFFIATORE PER POLVERE .....	405	KNOWLES FORBICI PER BENDAGGI .....	70	LANE TRETOWAN ELEVATORE PER OSSA .....	290
KADER SPATOLA ADDOMINALE ED INTESTINALE .....	143/1	KOCHER DIVARICATORE .....	155	LANG DISSETTORE PER SACCO LACRIMALE .....	378
KALLMORGEN SPECOLO VAGINALE .....	573	KOCHER DIVARICATORE .....	159	LANGE INSERTO .....	472
KALT PINZA CAPSULARE .....	391	KOCHER DIVARICATORE .....	160	LANGE UNCINO PER LE PINNE NASALI .....	448
KALT, PORT'AGHI .....	214	KOCHER DIVARICATORE .....	163	LANGE-HOHMANN ELEVATORE PER OSSA .....	286
KALT-ARRUGA PORT'AGHI .....	214	KOCHER DIVARICATORE .....	163	LANGENBECK ANSA AURICOLARE .....	409
KANE PINZA OMBELICALE .....	605	KOCHER PINZA EMOSTATICA .....	108	LANGENBECK COLTELLO PER AMPUTAZIONE .....	44
KANTROWITZ PINZA EMOSTATICA .....	119/1	KOCHER PINZA INTESTINALE .....	540	LANGENBECK COLTELLO PER CARTILAGINI .....	47
KAYE FACE LIFT FORBICI .....	73	KOCHER SONDA PER GOZZO .....	479	LANGENBECK DIVARICATORE .....	158
		KOCHER SPATOLA VESCICALE .....	552	LANGENBECK DIVARICATORE .....	159
		KOCHER-LANGENBECK DIVARICATORE .....	159	LANGENBECK PERIOTOTOMO .....	275
		KOENIG AGO .....	223	LANGENBECK PORT'AGHI .....	213
		KOERTE DIVARICATORE .....	162	LANGENBECK SEGA PER DITA .....	296

LANGENBECK TENAGLIA PER OSSA.....	243	LOWMAN-HOGLUND PINZA PER OSSA.....	249	MATHIEU PINZA PER CORPI ESTRANEI.....	553/1
LANGENBECK-GREEN DIVARICATORE.....	153	LUBET-BARBON PINZA NASALE PER TAMPONI.....	424	MATHIEU PORT'AGHI.....	213
LARINGOSCOPIO MC INTOSH.....	29	LUC PINZA PER SETTO NASALE.....	426	MATHIEU SPECOLO RETTALE.....	560
LARINGOSCOPIO MILLER.....	30	LUCAE AGO PER PARACENTESI.....	408	MATHIEU-OLSEN PORT'AGHI.....	212
LARINGOSCOPIO PER OPERAZIONE KLEINSASSER.....	35	LUCAE DIAPASON.....	404	MATSON PERIOTOTOMO.....	279
LARINGOSCOPIO FOREGGER.....	29	LUCAE MARTELLINO.....	271	MATSON-ALEXANDER PERIOTOTOMO.....	279
LARSEN PINZA PER AFFERRARE TENDINI.....	292	LUCAE PINZA AURICOLARE.....	410	MAUNDER APRIBOCCA DI LEGNO.....	459
LAWRENCE PINZA EMOSTATICA.....	119	LUCAE UNCINO.....	409	MAXI GRASPER PINZA PER BIOPSIA.....	593
LEBSCH SCALPELLO PER STERNO.....	267	LUER CANNULA TRACHEALE.....	479	MAYFIELD PINZA SGORBIA.....	238
LEES PINZA PER BRONCHI.....	504	LUER DIVARICATORE.....	140	MAYO ABBASSALINGUA.....	451
LEGATORE EMORROIDALE, MC GIVNEY.....	568	LUER PINZA SGORBIA.....	236	MAYO CUCCHIAIO PER CALCOLI BILIARI.....	534
LEGATORE EMORROIDALE RUDD.....	568	LUER-KOERTE CUCCHIAIO PER CALCOLI BILIARI.....	533	MAYO FORBICI PER DISSEZIONE.....	52
LEGUE DIVARICATORE VESCICALE.....	553	LUKART FORCIPE.....	603	MAYO PINZA.....	89
LEGUEU SPATOLA VESCICALE.....	552	LUKART-BILL TRATTORE.....	604	MAYO SONDA PER CALCOLI BILIARI.....	534
LEKSELL(STILLE) PINZA SGORBIA.....	240	LUNDSGAARD SCLEPOTOMO.....	373	MAYO SPILLONE PER STERILIZZAZIONE.....	227
LELAND-JONES PINZA VASCOLARE.....	494	LUNIATSCHEK TAMPONATORE.....	465	MAYO SUPERCUT FORBICI.....	71
LEMPERT CURETTA TAGLIANTE.....	256	M.....		MAYO-ADAMS DIVARICATORE.....	171
LEMPERT ELEVATORE.....	420	M.....		MAYO-BLAKE PINZA PER CALCOLI BILIARI.....	531
LEMPERT PINZA SGORBIA.....	237	MAGILL PINZA PER INTRODUZIONE SONDE.....	28	MAYO-COLLINS DIVARICATORE.....	141
LERCHE PINZA DA PRESA.....	83	MAGLIA METALLICA PER ESTENSIONE.....	311	MAYO-COLLINS DIVARICATORE-SET.....	141
LERICHE PINZA EMOSTATICA.....	111	MALTZ (COTTLE) RASPA NASALE.....	444	MAYO-HABERISSER PINZA TORCIFILI.....	319
LERICHE SPATOLA ADDOMINALE E INTESTINALE.....	143/2	MALTZ RASPA NASALE.....	443	MAYO-HEGAR PORT'AGHI.....	209
LESINA.....	304	MANICI PER LAMA BISTURI.....	38	MAYON-GUYON PINZA EMOSTATICA.....	122
LESINA, PERTHES.....	304	MANICI PER LAMA BISTURI.....	39	MAYO-NOBLE FORBICI PER DISSEZIONE.....	52
LESTER PINZA FISSATRICE.....	389	MANICI PER LAMA BISTURI.....	39/1	MAYO-ROBSON PINZA INTESTINALE.....	541
LEVA PER CORPI ESTRANEI, BUCK.....	412	MANICI PER LAMA BISTURI.....	39/2	MAYO-STILLE FORBICI PER DISSEZIONE.....	52
LEVA PER CORPI ESTRANEI, QUIRE.....	412	MANICI PER LAMA BISTURI.....	40	MAYO-STILLE SUPERCUT FORBICI.....	71
LEVA PIEGAPLACCHE, LANE.....	325	MANICI PER LAMA BISTURI.....	41	MC DONALD ELEVATORE.....	283
LEVINSON AGO PER CORPI ESTRANEI.....	374	MANICO.....	266	MC INDOE CESOIA PER OSSA.....	241
LEWIN TENAGLIA PER OSSA.....	246	MANICO.....	266	MC INTOSH LARINGOSCOPIO.....	29
LEXER BABY FORBICI PER DISSEZIONE.....	53	MANICO.....	300	MC INTOSH LARINGOSCOPIO SET.....	31
LEXER FORBICI PER DISSEZIONE.....	53	MANICO A BATTERIA PER LUCE CALDA.....	32	MC KENZIE PERFORATORE.....	299
LEXER MINI SGORBIA.....	263	MANICO A BATTERIA PER LUCE CALDA.....	34	MCCULLOUGH PINZA PER STRABISMO.....	385
LEXER OSTEOTOMO.....	263	MANICO A BATTERIA PER LUCE FREDDA.....	33	MC GEE MIKRO-PINZA AURICOLARE.....	414
LEYLA SISTEMA DI FISSAGGIO.....		MANICO A T, HUDSON.....	300	MC GEE UNCINO.....	419
.....368, 368/1, 368/2, 368/3, 368/4		MANICO CON ATTACCO RAPIDO.....	301	MCGIVNEY LEGATORE EMORROIDALE.....	568
LICHTENBERG PORT'AGHI.....	213	MANICO D'ASPIRAZIONE WULLSTEIN.....	338	MCGIVNEY PINZA EMORROIDALE.....	568
LICHTWITZ CANNULA.....	433	MANICO PER STRUMENTI MICROLARINGEI.....	475	MCINDOE FORBICI PER CARTILAGINE.....	65/1
LICHTWITZ TREQARTO PER SENO MASCELLARE.....	204	MANICO UNIVERSALE, HUBER.....	472	MCINDOE PINZA CHIRURGICA.....	85
LIEBERMANN BLEFAROSTATO.....	371	MANO DI PIOMBO.....	250	MCINTYRE CANNULA OCULISTICA.....	394
LIMA PER OSSA.....	294	MARCATORE, CONNIN-AMSLER.....	380	MCIVOR APRIBOCCA.....	457
LIMA PER OSSA.....	612/1	MARQUARDT PINZA SGORBIA.....	239	MCKENY ELEVATORE PER SETTO.....	437
LIMETTA PER LE UNGHIE.....	610	MARSHCHIK PINZA PER TONSILLE.....	468	MCKENZIE PINZA POSA CLIPS.....	326
LISTER FORBICI PER BENDAGGI.....	69/1	MARTEL PINZA DA PRESA.....	110	MCCLEAN FORCIPE.....	603
LISTER SUPERCUT FORBICI.....	72	MARTELLO DI PERCUSSIONE, BABINSKY.....	24	MCCLEAN-LUIKART FORCIPE.....	603
LISTER(SINUS) TUPFERZA.....	137	MARTELLO DI PERCUSSIONE, BERLINER.....	24	MCCLEAN-TUCKER-LUIKART FORCIPE.....	603
LISTER-BURCH BLEFAROSTATO.....	370	MARTELLO DI PERCUSSIONE, BUCK.....	24	MCPHERSON PINZA PER FILO.....	392
LISTON CESOIA PER OSSA.....	241	MARTELLO DI PERCUSSIONE, TAYLOR.....	24	MEAD MARTELLO.....	271
LISTON COLTELLO PER AMPUTAZIONE.....	44	MARTELLO DI PERCUSSIONE, TROEMNER.....	24	MEAD PINZA SGORBIA.....	235
LITTAUER FORBICI PER LEGATURE.....	66	MARTELLO IN PLASTICA.....	271	MEEKER PINZA EMOSTATICA.....	119
LITTAUER PINZA AURICOLARE.....	411	MARTELLO, BERGMANN.....	272	MEHDORN CLIPS PER VASI.....	362
LITTAUER PINZA DEPIULATORIA.....	395	MARTELLO, COLLIN.....	270	MEHDORN PINZA POSA CLIPS.....	362
LITTAUER PINZA PER POLIPI.....	425	MARTELLO, COTTLE.....	273	MELLINGER BLEFAROSTATO.....	370
LITTLE DIVARICATORE.....	157	MARTELLO, GERZOG.....	270	MELLINGER-AXENFELD BLEFAROSTATO.....	370
LITTLER IRIS FORBICI.....	55	MARTELLO, HAJEK.....	273	MENGHINI AGO PER BIOPSIA.....	206
LITTLEWOOD PINZA PER AFFERRARE INTESTINI.....	538	MARTELLO, HEATH.....	273	MERCEDES DIVARICATORE PER TORACE.....	489
LOCKHART-MUMMERY SPECILLO PER FISTOLE.....	200	MARTELLO, KIRK.....	270	MERIAM PINZA DENTALE.....	93
LOCKLIN FORBICE GINGIVALI.....	69	MARTELLO, LUCAE.....	271	METZENBAUM FINO TC FORBICI PER DISSEZIONE.....	53/1
LOCKWOOD-ALLIS PINZA PER AFFERRARE INTESTINI.....	538	MARTELLO, MEAD.....	271	METZENBAUM FORBICI PER CHIRURGIA.....	54
LONDON-COLLEGE PINZA DENTALE.....	93	MARTELLO, OMBREDANNE.....	273	METZENBAUM FORBICI PER DISSEZIONE.....	53/1
LOPEZ-REINKE DISSETTORE PER TONSILLE.....	465	MARTELLO, PARTSCH.....	271	METZENBAUM PORT'AGHI.....	211
LORENZ FORBICI PER BENDAGGI.....	70	MARTELLO, QUISLING.....	271	METZENBAUM SUPERCUT FORBICI.....	71
LORNA PINZA FISSATELI.....	133	MARTELLO, WILLIGER.....	271	METZENBAUM TC FORBICI PER DISSEZIONE.....	53/1
LOUTE STRUMENTO TENDIFILI.....	315	MARTIN DIVARICATORE.....	175/1	MEYERDING DIVARICATORE.....	157
LOVE DIVARICATORE.....	465	MARTIN FORBICI PER CARTILAGINE.....	65/1	MEYERDING DIVARICATORE.....	177
LOVE UNCINO PER NERVI.....	329/2	MARTIN ISTEROMETRO.....	586	MEYERDING DIVARICATORE.....	180
LOVE UNCINO PER RADICI DEI NERVI.....	330	MARTIN PELVIMETRO.....	605	MEYHOEFER CURETTA DA CALAZIO.....	377
LOVE-GRUENWALD PINZA TAGLIANTE PER		MARTIN TENAGLIA PER OSSA.....	246	MICHEL AGRAFES.....	224
LAMINECTOMIA.....	340	MARTINI CURETTA TAGLIANTE.....	257	MICHEL PINZA PER AGRAFES.....	224
LOVELACE PINZA EMOSTATICA.....	109	MASING-NEIVERT UNCINO NASALE.....	447/1	MICHEL SPECCHIO LARINGEO.....	423
LOVELACE PINZA PER AFFERRARE IL POLMONE.....	490	MASSON PORT'AGHI.....	210	MICRO FORBICI.....	76
LOWER PINZA EMOSTATICA.....	120	MASTIN PINZA MUSCOLARE.....	479	MICRO FORBICI.....	77
LOWMAN PINZA PER OSSA.....	249	MATHIEU DIVARICATORE.....	141	MICRO FORBICI.....	78



MICRO FORBICI AURICOLARI, BELLUCCI.....	413	MUSEUX PINZA PER ABBASSARE IL COLLO		O'SULLIVAN-O'CONNOR SPECOLO VAGINALE.....	576
MICRO FORBICI AURICOLARI, SHEA.....	413	DELL'UTERO.....	583	OTIS URETROTOMO.....	553
MICRO FORBICI, GOMEL.....	80	MYLES PINZA NASALE.....	427	OVERHOLT PINZA EMOSTATICA.....	114
MICRO FORBICI, HEPP-SCHEIDEL.....	78	N		OVERHOLT-BABY PINZA EMOSTATICA.....	114
MICRO FORBICINE, BELLUCCI.....	417	NABATOFF SET PER VARICI IN SCATOLA DI METALLO ...	201	OVERHOLT-GEISENDOERFER PINZA EMOSTATICA.....	114
MICRO FRIEDMANN PINZA SGORBIA.....	234	NAEGELE FORCIPE.....	602	OVERHOLT-MIXTER PINZA EMOSTATICA.....	115
MICRO PINZA AURICOLARE.....	415	NAGER AGO PER TONSILLE.....	466		
MICRO PINZA AURICOLARE A CUCCHIAIO		NAGER DIVARICATORE.....	465	P	
WULLSTEIN.....	416	NEFF COLTELLO PER MENISCO.....	292	PADELLA.....	621
MICRO-HARTMANN PINZA EMOSTATICA.....	104	NEGUS PINZA PER TONSILLE.....	467	PARK BLEFAROSTATO.....	371
MICROPINZA CHIRURGICA, GOMEL.....	96	NEGUS SUPPORTO PER PETTO.....	459	PARKER DIVARICATORE.....	139
MICROVASCULAR PORT'AGHI.....	210	NEIVERT PORT'AGHI.....	208	PARTSCH MARTELLO.....	271
MIDDELDRPF DIVARICATORE.....	160	NEIVERT-ANDERSON OSTEOTOMO NASALE.....	442	PARTSCH SCALPELLO.....	259
MIDDLETON-JANSEN PINZA PER SETTO NASALE.....	430	NELATON SPECILLO SCANALATO.....	199	PARTSCH SGORBIA.....	259
MIKRO COLTELLO FALCATO.....	475	NELSON AGO PER LEGATURE.....	219	PASSOW PESTELLO DA TAMPONARE.....	260
MIKRO SEPERATORE.....	475	NELSON STANDARD TREQUARTO.....	204	PATON DISETTORE CORNEALE.....	373
MIKRO UNCINO.....	475	NELSON TREQUARTO.....	205	PAUFIQUE COLTELLO PER CHERATOPLASTICA.....	373
MIKRO-PINZA AURICOLARE.....	413	NEONATAL PINZA VASCOLARE CASTANEDA.....	527	PAUFIQUE PINZA PER FILO.....	392
MIKRO-PINZA AURICOLARE, COS.....	414	NEWS DIVARICATORE TRACHEALE.....	477	PAYR SCHIACCIATORE PER L'INTESTINO E LO	
MIKRO-PINZA AURICOLARE, DIETER.....	414	NISSEN PINZA EMOSTATICA.....	113	STOMACO.....	548
MIKRO-PINZA AURICOLARE, GREVEN.....	414	NORFOLK-NORWICH DIVARICATORE.....	172	PAYR SPECILLO DI GUIDA SCANALATO.....	221
MIKRO-PINZA AURICOLARE, HAUGH.....	414	NORTHBENT FORBICI PER LEGATURE.....	66	PEAN PINZA DA PRESA.....	110
MIKRO-PINZA AURICOLARE, JUERS.....	414	NOTO PINZA PER POLIPI UTERINI.....	585	PEAN PINZA EMOSTATICA.....	108
MICRO-PINZA AURICOLARE, MCGEE.....	414	NOVA, SFGIOMANOMETRO.....	6,7	PECK-JOSEPH FACE LIFT FORBICI.....	74
MIKULICZ DIVARICATORE.....	163	NOVAK CURETTA PER BIOPSIA.....	587	PECK-JOSEPH FACE LIFT FORBICI.....	74
MIKULICZ PINZA INTESTINALE.....	543	NOYES FORBICI OCULISTICHE.....	75	PEDERSON SPECOLO VAGINALE.....	570
MIKULICZ PINZA PERITONEALE.....	123	NOYES PINZA PER POLIPI.....	425	PEENFIELD DISSETTORE.....	333
MIKULICZ-BABY PINZA PERITONEALE.....	123	O		PEERS PINZA FISSATELI.....	132
MILLER LARINGOSCOPIO.....	30	OBWEGESER AGO DI INTRODUZIONE.....	463	PEET PINZA PER SCHEGGE.....	92
MILLER RASPA NASALE.....	444	OBWEGESER AGO DI INTRODUZIONE.....	463/3	PEET RASPA NASALE.....	446
MILLIGAN DURA DISSETTORE.....	332	OBWEGESER DIVARICATORE.....	460, 461	PELMANN PINZA PER MEDICATURA.....	137
MILLIN DIVARICATORE VESCICALE.....	552	OBWEGESER OSTEOTOMO A LAMA.....	464/1	PELVIMETRO, COLLIER.....	605
MILLIN DIVARICATORE VESCICALE.....	553	OBWEGESER PERIOSTOTOMO.....	461, 462, 463	PELVIMETRO, COLLIN.....	605
MILLIN PINZA CAPSULARE DA PRESA.....	551	OCCHIALI NISTAGMO FRENZEL.....	20	PELVIMETRO, MARTIN.....	605
MILLIN PINZA DA PRESA PER LA PROSTATA.....	551	OCHSNER TREQUARTO.....	205	PENNINGTON ELEVATORE PER SETTO.....	438
MINI MANICO CON ATTACCO RAPIDO.....	301	O'CONNOR UNCINO PER IRIDE.....	375	PENNINGTON PINZA EMOSTATICA.....	109
MINI-LAMBOTTE OSTEOTOMO.....	262	OEHLER PINZA CHIRURGICA.....	81/1	PERCY RETRATTORE.....	296
MINIMUS II, SFGIOMANOMETRO.....	11	OLDBERG PINZA TAGLIANTE PER LAMINECTOMIA.....	341	PERFORATORE A MANO, BUNELL.....	299
MINIMUS III, SFGIOMANOMETRO.....	12	OLIO PER STRUMENTI INSTRU CARE.....	634	PERFORATORE A MANO, HUDSON KPLT.....	299
MIXTER PINZA CURVA AD "S".....	116	OLIVA NASALE POLITZER.....	406	PERFORATORE A MANO, KIRSCHNER.....	299
MIXTER PINZA PER CALCOLI BILIARI.....	531	OLIVECRONA DURA DISSETTORE.....	332	PERFORATORE A MANO, MOORE.....	298
MIXTER-BABY PINZA EMOSTATICA.....	119/1	OLIVECRONA PINZA SGORBIA.....	237	PERFORATORE A MANO, RALK.....	300
MIXTER-O'SHAUGNESSY PINZA EMOSTATICA.....	119/2	OLIVECRONA SEGA IN FILO D'ACCIAIO.....	332	PERFORATORE A MANO, STILLE.....	298
MOD. BONN PINZA PER IRIDE.....	387	OLIVECRONA SPATOLA CEREBRALE.....	336	PERFORATORE A MANO, STILLE-SHERMAN.....	298
MOD. TÜBINGEN PINZA PER IRIDE.....	387	OLIVECRONA-TOENNIS (SCOVILLE).....	326	PERFORATORE ELICOIDALE.....	302
MOD.MÜNCHEN CURETTA PER BIOPSIA.....	587	OLIVECRONA-TOENNIS PINZA POSA CLIPS.....	326	PERFORATORE INTRAMIDOLLARE.....	322
MOD.VIENNA SPECOLO NASALE.....	421	OLLIER DIVARICATORE.....	162	PERFORATORE CRUTCHFIELD.....	327
MODELLATORE PER CHIODI, BENDER.....	322	OLSEN-HEGAR PORT'AGHI.....	212	PERFORATORE, CUSHING.....	299
MODELLO RUSSO, PINZA DA PRESA.....	85	OMBREDANNE MARTELLO.....	273	PERFORATORE, ERRICO.....	299
MODELLO STRASSBURG PINZA CHIRURGICA.....	89	OSTEOTOME, COTTLE.....	440	PERFORATORE, MC KENZIE.....	299
MOELTGEN GONIOMETRO.....	25	OSTEOTOMI.....	259	PERFORATORE, SMELLIE.....	607
MOGEN STRUMENTO PER CIRCONCISIONE.....	556	OSTEOTOMI.....	464	PERFORATORI FILIFORME KIRSCHNER.....	306, 307
MOLLISON DIVARICATORE.....	171	OSTEOTOMI EPKER.....	464/2	PERIOSTOTOMO.....	279
MOLT PERIOSTOTOMO.....	276	OSTEOTOMO A LAMA OBWEGESER.....	464/1	PERIOSTOTOMO MOLT.....	276
MONOPOLAR ELEKTRODEN ANSAN.....	628, 629	OSTEOTOMO LEXER.....	263	PERIOSTOTOMO SELDIN.....	277
MOOR CUCCHIAIO PER CALCOLI BILIARI.....	532	OSTEOTOMO MINI-LAMBOTTE.....	262	PERIOSTOTOMO, ADSON.....	282
MOORE PERFORATORE A MANO.....	298	OSTEOTOMO NASALE NEIVERT-ANDERSON.....	442	PERIOSTOTOMO, ALEXANDER.....	276
MOORFIELD PINZA PER SUTURA.....	392	OSTEOTOMO PER SETTO, COTTLE.....	440	PERIOSTOTOMO, COBB.....	280
MORGAN PROCTOSCOPIO.....	565	OSTEOTOMO PER SETTO, FOMON.....	441	PERIOSTOTOMO, DINGMANN.....	463
MORITZ-SCHMIDT ABBASSALINGUA.....	452	OSTEOTOMO PER SETTO, SHEEHAN.....	441	PERIOSTOTOMO, DOYEN.....	278
MORRIS DIVARICATORE.....	164	OSTEOTOMO, HIBBS.....	265	PERIOSTOTOMO, FARABEUF.....	274
MORRIS-DEBAKEY PINZA AORTA.....	506	OSTEOTOMO, LAMBOTTE.....	261	PERIOSTOTOMO, FARABEUF-COLLIN.....	274
MORSE DIVARICATORE COSTALE.....	484	OSTEOTOMO, SMITH-PETERSEN.....	261	PERIOSTOTOMO, FOMON.....	277
MORSE-FAVALORO DIVARICATORE COSTALE.....	484	OSTEOTOMO, STILLE.....	260	PERIOSTOTOMO, JOSEPH.....	277
MORSETTO PER SISTEMA BRACCIO.....	189	OSTETOTOMO PER SETTO RUBIN.....	440	PERIOSTOTOMO, KOENIG.....	276
MOYNIHAN PINZA EMOSTATICA.....	120	OSTROEM PINZA TAGLIANTE PER SETTO NASALE.....	430	PERIOSTOTOMO, LAMBOTTE.....	274
MOYNIHAN PINZA FISSATELI.....	133	OSTROEM PINZA TAGLIANTE PER SETTO NASALE.....	430	PERIOSTOTOMO, LANGENBECK.....	275
MOYNIHAN SONDA PER CALCOLI BILIARI.....	532	O'SULLIVAN-O'CONNOR DIVARICATORE		PERIOSTOTOMO, MATSON.....	279
MUELLER BLEFAROSTATO.....	371	ADDOMINALE.....	181	PERIOSTOTOMO, MATSON-ALEXANDER.....	279
MÜLLER CLIPS PER VASI.....	364, 365	O'SULLIVAN-O'CONNOR DIVARICATORE		PERIOSTOTOMO, OBWEGESER.....	461, 462, 463
MURDOCK BLEFAROSTATO.....	370	ADDOMINALE.....	181	PERIOSTOTOMO, SEMB.....	278
MURPHY DIVARICATORE.....	156	O'SULLIVAN-O'CONNOR DIVARICATORE		PERIOSTOTOMO, WILLIGER.....	276
MURPHY-LANE ELEVATORE.....	283	ADDOMINALE.....	181	PERKINS DIVARICATORE.....	168

PERTHES LESINA.....	304	PINZA CHIRURGICA, ADSON-BROWN.....	82	PINZA EMOSTATICA, KELLY-RANKIN.....	106
PESTALOZZA CURETTA PER ABORTO.....	606	PINZA CHIRURGICA, BONNEY.....	88	PINZA EMOSTATICA, LAHEY.....	119/2
PESTELLO DA TAMPONARE, PASSOW.....	260	PINZA CHIRURGICA, BROPHY.....	84	PINZA EMOSTATICA, LAWRENCE.....	119
PETZ APPARECCHIATURA DI SUTURA		PINZA CHIRURGICA, CUSHING.....	83	PINZA EMOSTATICA, LERICHE.....	111
GASTRO-INTESTINALE.....	549	PINZA CHIRURGICA, FERRIS-SMITH.....	84	PINZA EMOSTATICA, LOVELACE.....	109
PHANEUF PINZA PERITONEALE.....	123	PINZA CHIRURGICA, GILLIES.....	86	PINZA EMOSTATICA, LOWER.....	120
PIERCE ELEVATORE PER SETTO.....	438	PINZA CHIRURGICA, LANE.....	84	PINZA EMOSTATICA, MAYO-GUYON.....	122
PIERCE TREQUARTO PER SENO MASCELLARE.....	204	PINZA CHIRURGICA, MCINDOE.....	85	PINZA EMOSTATICA, MEEKER.....	119
PIFFARO CURETTA PER LUPUS.....	608	PINZA CHIRURGICA, MOD.USA.....	81/1	PINZA EMOSTATICA, MICRO-HARTMANN.....	104
PILLING PINZA APPLICATORE CLIPS SMAL.....	524, 525	PINZA CHIRURGICA, OEHLER TC.....	81/1	PINZA EMOSTATICA, MIXTER.....	119/1
PINARD STETOSCOPIO.....	23	PINZA CHIRURGICA, SEMKEN.....	86	PINZA EMOSTATICA, MIXTER-BABY.....	119/1
PINZA PER CORPI ESTRANEI, HARTMANN.....	412	PINZA CHIRURGICA, STILLE.....	81/1	PINZA EMOSTATICA, MOYNIHAN.....	120
PINZA PER CORPI ESTRANEI,		PINZA CHIRURGICA, TAYLOR.....	87	PINZA EMOSTATICA, O'SHAUGNESSY.....	119/2
HARTMANN-HOFFMANN.....	412	PINZA COPERCHIO REDA.....	615	PINZA EMOSTATICA, PENNINGTON.....	109
PINZA PER CORPI ESTRANEI,		PINZA CURVA AD "S" MIXTER.....	116	PINZA EMOSTATICA, PROVIDENCE-HOSPITAL.....	106
HARTMANN-WULLSTEIN.....	412	PINZA DA PRESA.....	316,317	PINZA EMOSTATICA, ROBERTS.....	117
PINZA VASCOLARE, WANGENSTEEN.....	89	PINZA DA PRESA COTTLE.....	410	PINZA EMOSTATICA, ROCHESTER-CARMALT.....	109
PINZA AD ASTA TUBOLARE PER MICROCHIRURGIA.....	474	PINZA DA PRESA PER FILI KIRSCHNER.....	305	PINZA EMOSTATICA, ROCHESTER-OCHSNER.....	108
PINZA ANATOMICA STANDARD.....	81	PINZA DA PRESA PER LA PROSTATA, MILLIN.....	551	PINZA EMOSTATICA, ROCHESTER-PEAN.....	108
PINZA ANATOMICA, ADSON.....	82	PINZA DA PRESA PER TONSILLE ABRAHAM.....	468	PINZA EMOSTATICA, RUMEL.....	117
PINZA ANATOMICA, ADSON MICRO.....	82	PINZA DA PRESA PER TUMORI, LANDOLT.....	341	PINZA EMOSTATICA, SAROT.....	118
PINZA ANATOMICA, BONNEY.....	88	PINZA DA PRESA, COLLIN-DUVAL.....	85	PINZA EMOSTATICA, SPENCER-WELLS.....	109
PINZA ANATOMICA, BONNEY.....	88	PINZA DA PRESA, DURANTE.....	88	PINZA EMOSTATICA, STILLE.....	122
PINZA ANATOMICA, BROPHY.....	84	PINZA DA PRESA, DUVAL.....	85	PINZA EMOSTATICA, TOENNIS.....	117
PINZA ANATOMICA, CUSHING.....	83	PINZA DA PRESA, GRAEFE.....	83	PINZA EMOSTATICA, ZENKER.....	118
PINZA ANATOMICA, GERALD.....	86	PINZA DA PRESA, LERCHE.....	83	PINZA EMOSTATICA, OVERHOLT-BABY.....	114
PINZA ANATOMICA, MCINDOE.....	85	PINZA DA PRESA, MARTEL.....	110	PINZA EMOSTATICA, OVERHOLT-GEISSENDÖRFER.....	114
PINZA ANATOMICA, MOD.USA.....	81	PINZA DA PRESA, MODELLO RUSSO.....	85	PINZA EMOSTATICA, OVERHOLT-MIXTER.....	115
PINZA ANATOMICA, POTTS-SMITH.....	81	PINZA DA PRESA, PEAN.....	110	PINZA FISSATELI.....	133
PINZA ANATOMICA, SEMKEN.....	86	PINZA DA PRESA, PRATT.....	110	PINZA FISSATELI BALL AND SOCKET.....	133
PINZA ANATOMICA, STILLE.....	81	PINZA DA PRESA, WILLET MARTEL.....	110	PINZA FISSATELI, BACKHAUS.....	132
PINZA ANATOMICA, TAYLOR.....	87	PINZA DENTALE LONDON-COLLEGE.....	93	PINZA FISSATELI, BERNHARD.....	133
PINZA ANATOMICA, TC.....	81	PINZA DENTALE MERIAM.....	93	PINZA FISSATELI, DOYEN.....	133
PINZA ANEURISMA DEBAKEY-BAHNSON.....	506	PINZA DEPILATORIA BEER.....	395	PINZA FISSATELI, JONES.....	132
PINZA AORTA DIETRICH.....	510	PINZA DEPILATORIA, BARRAQUER.....	395	PINZA FISSATELI, LANE.....	133
PINZA AORTA MORRIS-DEBAKEY.....	506	PINZA DEPILATORIA, DOUGLAS.....	395	PINZA FISSATELI, LORNA.....	133
PINZA ATRAUMATICA BULLDOG, DE BAKEY.....	100	PINZA DEPILATORIA, GRADLE.....	395	PINZA FISSATELI, MOYNIHAN.....	133
PINZA ATRAUMATICA BULLDOG, GLOVER.....	100	PINZA DEPILATORIA, LITTAUER.....	395	PINZA FISSATELI, PEERS.....	132
PINZA ATRAUMATICA IN TITANIO, DEBAKEY.....	99	PINZA DEPILATORIA, REDA.....	395	PINZA FISSATELI, ROEDER.....	132
PINZA ATRAUMATICA PER NEONATI E BAMBINI.....	523	PINZA EMORROIDALE FERGUSSON.....	109	PINZA FISSATELI, SCHAEDEL.....	132
PINZA ATRAUMATICA TC DEBAKEY.....	99	PINZA EMORROIDALE, MCGIVNEY.....	568	PINZA FISSATELI, TOHOKU.....	132
PINZA AURICOLARE, HARTMANN.....	411	PINZA EMOSTATICA BIRKETT.....	116	PINZA FISSATRICE, BARRAQUER.....	390
PINZA AURICOLARE, HEYMANN-KNIGHT.....	425	PINZA EMOSTATICA BRIDGE.....	116	PINZA FISSATRICE, CASTROVIEJO.....	390
PINZA AURICOLARE, JANSEN.....	424	PINZA EMOSTATICA COLLER-CRILE.....	106	PINZA FISSATRICE, ELSCHNIG.....	389
PINZA AURICOLARE, LITTAUER.....	411	PINZA EMOSTATICA DEBAKEY-MOSQUITO.....	509	PINZA FISSATRICE, GRAEFE.....	389
PINZA AURICOLARE, LUCAE.....	410	PINZA EMOSTATICA DEBAKEY-PEAN.....	513	PINZA FISSATRICE, GREEN.....	390
PINZA AURICOLARE, TILLEY.....	411	PINZA EMOSTATICA DEBAKEY-RANKIN.....	512	PINZA FISSATRICE, LESTER.....	389
PINZA AURICOLARE, TROELTSCH.....	424	PINZA EMOSTATICA FUCHSIG.....	113	PINZA INTESTINALE BRUNNER.....	543
PINZA AURICOLARE, WILDE (TROELTSCH).....	410	PINZA EMOSTATICA KANTROWITZ.....	119/1	PINZA INTESTINALE PER BIOPSIA, TURREL.....	567
PINZA AURICOLA, HARKEN.....	503	PINZA EMOSTATICA KOCHER.....	108	PINZA INTESTINALE PER BIOPSIA, YEOMAN.....	566, 567
PINZA BIPOLARE.....	630, 631	PINZA EMOSTATICA NISSEN.....	113	PINZA INTESTINALE SCUDDER.....	541
PINZA BIPOLARE A BAIONETTA.....	631, 632	PINZA EMOSTATICA OVERHOLT.....	114	PINZA INTESTINALE, BABY-KOCHER.....	540
PINZA CAPSULARE DA PRESA, MILLIN.....	551	PINZA EMOSTATICA PEAN.....	108	PINZA INTESTINALE, DOYEN.....	540
PINZA CAPSULARE, ARRUGA.....	391	PINZA EMOSTATICA WIKSTROEM.....	117	PINZA INTESTINALE, FEHLAND.....	542
PINZA CAPSULARE, CASTROVIEJO.....	391	PINZA EMOSTATICA, ADSON.....	112	PINZA INTESTINALE, KOCHER.....	540
PINZA CAPSULARE, ELSCHNIG.....	391	PINZA EMOSTATICA, ADSON-BABY.....	113	PINZA INTESTINALE, MAYO-ROBSON.....	541
PINZA CAPSULARE, FUCHS.....	391	PINZA EMOSTATICA, BAINBRIDGE.....	119/2	PINZA INTESTINALE, MIKULICZ.....	543
PINZA CAPSULARE, GILL-ARRUGA.....	390	PINZA EMOSTATICA, BENGOLEA.....	112	PINZA INTESTINALE, RESANO.....	542
PINZA CAPSULARE, HESS.....	391	PINZA EMOSTATICA, CRAFOORD.....	118	PINZA INTESTINALE,STONE-WATT.....	545
PINZA CAPSULARE, KALT.....	391	PINZA EMOSTATICA, CRAFOORD-SELLORS.....	119	PINZA MAYO.....	89
PINZA CAPSULARE, SCHWEIGGER.....	391	PINZA EMOSTATICA, CRILE.....	107	PINZA MODELLO STRASSBURG.....	89
PINZA CAPSULARE, TERSON.....	391	PINZA EMOSTATICA, CRILE-RANKIN.....	107	PINZA MUSCOLARE, BERKE.....	389
PINZA CARDIOVASCOLARE ATRAUMATICA.....	526	PINZA EMOSTATICA, DANDY.....	109	PINZA MUSCOLARE, MASTIN.....	479
PINZA CARDIOVASCOLARE ATRAUMATICA COOLEY.....	518, 519, 522	PINZA EMOSTATICA, DESJARDINS.....	121	PINZA MUSCOLARE, PRINCE.....	387
PINZA CARDIOVASCOLARE ATRAUMATICA DERRA.....	515	PINZA EMOSTATICA, GEMINI.....	115	PINZA NASALE GRAIG.....	426
PINZA CARDIOVASCOLARE ATRAUMATICA GREGORY.....	517	PINZA EMOSTATICA, GRAY.....	121	PINZA NASALE PER TAMPONI LUBET-BARBON.....	424
PINZA CHIRURGICA GERALD.....	87	PINZA EMOSTATICA, GUYON.....	122	PINZA NASALE PER TAMPONI WESTMACOTT.....	424
PINZA CHIRURGICA POTTS SMITH.....	81	PINZA EMOSTATICA, HALSTED-MOSQUITO.....	105	PINZA NASALE WEIL-BLAKESLEY.....	426
PINZA CHIRURGICA STANDARD.....	81/1	PINZA EMOSTATICA, HARTMANN.....	104	PINZA NASALE, CAPLAN.....	428
PINZA CHIRURGICA WAUGH.....	83	PINZA EMOSTATICA, HEISS.....	112	PINZA NASALE, HARTMANN.....	427
PINZA CHIRURGICA, ADSON.....	82	PINZA EMOSTATICA, JACOBSON.....	105	PINZA NASALE, MYLES.....	427
PINZA CHIRURGICA, ADSON MICRO.....	82	PINZA EMOSTATICA, JOHNS-HOPKINS.....	120	PINZA NASALE, SCHMEDEN.....	427
		PINZA EMOSTATICA, KELLY.....	106	PINZA NASALE, TAKAHASHI.....	427

PINZA NASALE, WATSON-WILLIAMS.....	428	PINZA PER AGRAFES, RICHTER-HEATH.....	224	PINZA PER IRIDE, GRAEFÉ.....	382
PINZA NASALE, STRUYCKEN.....	427	PINZA PER ANASTOMOSI DEL RETTO, HAYES.....	545	PINZA PER IRIDE, HESS.....	384
PINZA OMBELICALE, COLLIN.....	605	PINZA PER ANASTOMOSI, BECK.....	516	PINZA PER IRIDE, KIRBY-ARTHUR.....	385
PINZA OMBELICALE, KANE.....	605	PINZA PER ANASTOMOSI, BECK.....	520	PINZA PER IRIDE, MOD. BONN.....	387
PINZA PER ABBASSARE IL COLLO DELL'UTERO CZERNY.....	584	PINZA PER ANASTOMOSI, COOLEY-DERRA.....	519	PINZA PER IRIDE, MOD. TUEBINGEN.....	387
PINZA PER ABBASSARE IL COLLO DELL'UTERO SCHRÖDER.....	583, 584	PINZA PER ANASTOMOSI, DE MARTEL-WOLFSON.....	546	PINZA PER IRIDE, TROUTMAN.....	389
PINZA PER ABBASSARE IL COLLO DELL'UTERO, BARRET.....	582	PINZA PER ANASTOMOSI, DEBAKEY.....	505	PINZA PER IRIDE, STEVENS.....	383
PINZA PER ABBASSARE IL COLLO DELL'UTERO, BRAUN.....	582	PINZA PER ANASTOMOSI, LAMBERT-KAY.....	505	PINZA PER ISTERECTOMIA SEGOND.....	125
PINZA PER ABBASSARE IL COLLO DELL'UTERO, DUPLAY.....	582	PINZA PER AORTA PEDIATRICA, SUBRAMANIAN-MINIATURE.....	521	PINZA PER ISTERECTOMIA SEGOND-LANDAU.....	125
PINZA PER ABBASSARE IL COLLO DELL'UTERO, HULKA.....	583	PINZA PER AORTA, WEBER.....	501	PINZA PER ISTERECTOMIA, HEAN-Y.....	126
PINZA PER ABBASSARE IL COLLO DELL'UTERO, IOWA.....	584	PINZA PER APPENDICE, ALLEN.....	544	PINZA PER ISTERECTOMIA, HEANY-BALLENTINE.....	127
PINZA PER ABBASSARE IL COLLO DELL'UTERO, JACOBS.....	583	PINZA PER APPENDICE, KLEINSCHMIDT.....	544	PINZA PER ISTERECTOMIA, ROGERS.....	127
PINZA PER ABBASSARE IL COLLO DELL'UTERO, JARCHO.....	583	PINZA PER BIOPSIA BABY BURKE.....	590	PINZA PER ISTERECTOMIA, WERTHEIM.....	124
PINZA PER ABBASSARE IL COLLO DELL'UTERO, MUSEUX.....	583	PINZA PER BIOPSIA BABY TISCHLER.....	592	PINZA PER ISTERECTOMIA, WERTHEIM.....	128
PINZA PER ABBASSARE IL COLLO DELL'UTERO, PRATT.....	584	PINZA PER BIOPSIA SCHUMACHER.....	588, 589	PINZA PER LACERAZIONE UNGHIE, RADOLF.....	297
PINZA PER ABBASSARE IL COLLO DELL'UTERO, SCHROEDER.....	583, 584	PINZA PER BIOPSIA TOWNSEND.....	591	PINZA PER MEDICATURA.....	135
PINZA PER ABBASSARE IL COLLO DELL'UTERO, SCHROEDER (POZZI).....	582	PINZA PER BIOPSIA, ALEXANDER.....	589	PINZA PER MEDICATURA, BRYANT.....	137
PINZA PER ABBASSARE IL COLLO DELL'UTERO, SKENE.....	582	PINZA PER BIOPSIA, BURKE.....	590	PINZA PER MEDICATURA, CHERON.....	137
PINZA PER ABBASSARE IL COLLO DELL'UTERO, TEALE.....	583	PINZA PER BIOPSIA, EPPENDORFER.....	590	PINZA PER MEDICATURA, COLLIN.....	137
PINZA PER ABBASSARE IL COLLO DELL'UTERO, STAUDE-MOORE.....	582	PINZA PER BIOPSIA, FAURE.....	588	PINZA PER MEDICATURA, DUPLAY.....	134
PINZA PER ABORTO, SAENGER.....	606	PINZA PER BIOPSIA, KEVORK.....	592	PINZA PER MEDICATURA, FOERSTER.....	136
PINZA PER ABORTO, WINTER.....	606	PINZA PER BIOPSIA, KEVORKIAN.....	589	PINZA PER MEDICATURA, GROSS-MAIER.....	134
PINZA PER AFFERRARE IL POLMONE, LOVELACE.....	490	PINZA PER BIOPSIA, KEVORKIAN.....	591	PINZA PER MEDICATURA, LISTER (SINUS).....	137
PINZA PER AFFERRARE INTESTINI DOYEN-BABY.....	540	PINZA PER BIOPSIA, MAXI GRASPER.....	593	PINZA PER MEDICATURA, PELKMANN.....	137
PINZA PER AFFERRARE INTESTINI LOCKWOOD-ALLIS.....	538	PINZA PER BIOPSIA, SCHUBERT.....	588	PINZA PER MEDICATURA, RAMPLEY.....	136
PINZA PER AFFERRARE INTESTINI, ALLIS.....	537	PINZA PER BIOPSIA, SCHUBERT.....	588	PINZA PER MEDICATURA, SIMS-MAIER.....	134
PINZA PER AFFERRARE INTESTINI, ALLIS-ADAIR.....	537	PINZA PER BIOPSIA, THOMAS-GAYLOR.....	588	PINZA PER MEDICATURA, ULRICH.....	135
PINZA PER AFFERRARE INTESTINI, ALLIS-BABY.....	537	PINZA PER BIOPSIA, VAN DOREN.....	591	PINZA PER MICROCHIRURGIA.....	94
PINZA PER AFFERRARE INTESTINI, ATRAUMA.....	111	PINZA PER BIOPSIA, WITTMER.....	589	PINZA PER OCCLUSIONE TANGENZIALE, DEBAKEY-SATINSKY.....	502
PINZA PER AFFERRARE INTESTINI, BABCOCK.....	539	PINZA PER BIOPSIA, TISCHLER-MORGAN.....	590, 591	PINZA PER OSSA LAMBERT-LOWMAN.....	249
PINZA PER AFFERRARE INTESTINI, COLLIN.....	539	PINZA PER BIOPSIA, VAN DOREN.....	588	PINZA PER OSSA, FELDHEIM.....	249
PINZA PER AFFERRARE INTESTINI, DUVAL.....	539	PINZA PER BIOPSIA, WITTMER.....	589	PINZA PER OSSA, GERSTER.....	250
PINZA PER AFFERRARE INTESTINI, JUDD-ALLIS.....	538	PINZA PER BIOPSIA, TISCHLER-MORGAN.....	590	PINZA PER OSSA, LOWMAN.....	249
PINZA PER AFFERRARE INTESTINI, LITTLEWOOD.....	538	PINZA PER BRONCHI, FINOCCHIETTO.....	490	PINZA PER OSSA, LOWMAN-HOGLUND.....	249
PINZA PER AFFERRARE INTESTINI, THOMS-ALLIS.....	538	PINZA PER BRONCHI, HARRINGTON.....	490	PINZA PER PATELLA.....	248
PINZA PER AFFERRARE INTESTINI, WILLIAMS.....	539	PINZA PER BRONCHI, LEES.....	504	PINZA PER PEDUNCOLO RENALE, HERRICK.....	123
PINZA PER AFFERRARE L'UTERO, COLLIN.....	585	PINZA PER BRONCHI, PRICE-THOMAS.....	490	PINZA PER PEDUNCOLO RENALE, WERTHEIM-CULLEN.....	125
PINZA PER AFFERRARE L'UTERO, DARTIGUES.....	585	PINZA PER BRONCHI, SEMB.....	491	PINZA PER PILOLO, BENSON.....	544
PINZA PER AFFERRARE L'UTERO, SOMER.....	585	PINZA PER BRONCO-ESOFAGOSCOPIA, CHEVALIER-JACK.....	473	PINZA PER POLIPI LARINGEI FRAENKEL.....	471
PINZA PER AFFERRARE TENDINI.....	293	PINZA PER CALAZIO, AYER.....	393	PINZA PER POLIPI LARINGEI JURASZ.....	471
PINZA PER AFFERRARE TENDINI JACKSON.....	292	PINZA PER CALAZIO, DESMARRÉS.....	393	PINZA PER POLIPI LARINGEI, JACKSON.....	471
PINZA PER AFFERRARE TENDINI KLEINERT-KUTZ.....	294	PINZA PER CALAZIO, LAMBERT.....	393	PINZA PER POLIPI UTERINI, DOYEN.....	585
PINZA PER AFFERRARE TENDINI, BRAND.....	293	PINZA PER CALCOLI BILIARI BLAKE.....	531	PINZA PER POLIPI UTERINI, KELLY.....	585
PINZA PER AFFERRARE TENDINI, CAROLL.....	293	PINZA PER CALCOLI BILIARI DESJARDINS.....	531	PINZA PER POLIPI UTERINI, NOTO.....	585
PINZA PER AFFERRARE TENDINI, LARSEN.....	292	PINZA PER CALCOLI BILIARI MAYO-BLAKE.....	531	PINZA PER POLIPI, HARTMANN.....	424
PINZA PER AFFERRARE TENDINI, STEINMANN.....	292	PINZA PER CALCOLI BILIARI MIXTER.....	531	PINZA PER POLIPI, LITTAUER.....	425
PINZA PER AFFERRARE TESSUTI, BROWN.....	83	PINZA PER CALCOLI RENALI, HEIMING.....	536	PINZA PER POLIPI, NOYES.....	425
PINZA PER AFFERRARE TESSUTI, CHAPUT.....	110	PINZA PER CALCOLI RENALI, RANDALL.....	535	PINZA PER RADDRIZZARE IL SETTO NASALE, ASCH.....	449
PINZA PER AFFERRARE TESSUTI, COLLIN.....	110	PINZA PER CAROTIDE JAVID.....	511	PINZA PER RADDRIZZARE IL SETTO NASALE, WALSHAM.....	449
PINZA PER AFFERRARE TESSUTI, SINGLEY.....	88	PINZA PER CATETERI COOLEY.....	510	PINZA PER RIFIUTI SAUERBRUCH.....	227
PINZA PER AFFERRARE TESSUTI, TUFFIER.....	110	PINZA PER COARTAZIONE E ANASTOMOSI POTTS.....	492, 493	PINZA PER RIPOSIZIONE, ROWE.....	459
PINZA PER AGRAFES, CHILDE.....	224	PINZA PER CORPI ESTRANEI STRUEMPEL.....	412	PINZA PER ROVESCiare PALPEBRE, SNELLEN.....	393
PINZA PER AGRAFES, COLLIN.....	224	PINZA PER CORPI ESTRANEI, MATHIEU.....	553-1	PINZA PER SCHEGGIE.....	91
PINZA PER AGRAFES, HEGENBARTH.....	224	PINZA PER CRANIOTOMIA CONE.....	331	PINZA PER SCHEGGIE, ARCHER.....	92
PINZA PER AGRAFES, MICHEL.....	224	PINZA PER EMORROIDI, HEYWOOD-SMITH.....	567	PINZA PER SCHEGGIE, CARMALT.....	91
PINZA PER AGRAFES, WACHENFELDT.....	224	PINZA PER FILO, MCPHERSON.....	392	PINZA PER SCHEGGIE, FELCHENFELD.....	91
		PINZA PER FILO, MOD. TUEBINGEN.....	392	PINZA PER SCHEGGIE, HUNTER.....	91
		PINZA PER FILO, PAUFIQUE.....	392	PINZA PER SCHEGGIE, PEET.....	92
		PINZA PER GOZZO, LAHEY.....	479	PINZA PER POLIPI, LITTAUER.....	425
		PINZA PER IL CUOIO CAPELLUTO, GAUSS.....	605	PINZA PER SCHEGGIE, VIRTUS (RALK).....	92
		PINZA PER INTRODUZIONE SONDE MAGILL.....	28	PINZA PER SCHEGGIE, STIEGLITZ.....	92
		PINZA PER IPOFISI.....	341	PINZA PER SETTO NASALE, BRUENINGS.....	425
		PINZA PER IPOFISI, ADSON.....	334	PINZA PER SETTO NASALE, HEYMANN.....	425
		PINZA PER IRIDE BARRAQUER (COLIBRI).....	384	PINZA PER SETTO NASALE, LUC.....	426
		PINZA PER IRIDE, BARRAQUER-KATZIN.....	384	PINZA PER SETTO NASALE, MIDDLETON-JANSEN.....	430
		PINZA PER IRIDE, BISHOP-HARMAN.....	386	PINZA PER SETTO NASALE, RUBIN.....	428
		PINZA PER IRIDE, BONN.....	387	PINZA PER SINUSCOPIA.....	431
		PINZA PER IRIDE, FISCHER.....	384	PINZA PER STERILIZZAZIONE.....	227
		PINZA PER IRIDE, FISCHER.....	383	PINZA PER STERILIZZAZIONE DAVIS.....	227
		PINZA PER IRIDE, GILL.....	384	PINZA PER STERILIZZAZIONE, CHEATLE.....	227
		PINZA PER IRIDE, GILL-HESS.....	384	PINZA PER STERILIZZAZIONE, ROGGE.....	227

PINZA PER STERILIZZAZIONE, UNIVERSAL.....	227
PINZA PER STRABISMO, BONACCOLTO.....	385
PINZA PER STRABISMO, DASTOOR.....	386
PINZA PER STRABISMO, JAMESON.....	385
PINZA PER STRABISMO, MCCULLOUGH.....	385
PINZA PER SUTURA, CASTROVIEJO.....	392
PINZA PER SUTURA, MOORFIELD.....	392
PINZA PER SUTURA, ST. MARTIN.....	392
PINZA PER TAMPONI, BOZEMANN.....	138
PINZA PER TAMPONI, BOZEMANN-DOUGLAS.....	138
PINZA PER TONSILLE COLVER.....	467
PINZA PER TONSILLE, BALLENGER.....	467
PINZA PER TONSILLE, BLOHME.....	467
PINZA PER TONSILLE, MARSCHIK.....	468
PINZA PER TONSILLE, NEGUS.....	467
PINZA PER TONSILLE, SAWTELL.....	467
PINZA PER TONSILLE, SCHNIDT.....	467
PINZA PER TONSILLE, TYDING.....	467, 468
PINZA PER TONSILLE, WHITE.....	467
PINZA PER TRACOMA, KNAPP-LUER.....	393
PINZA PER TRAZIONE CRANIALE, CRUTCHFIELD.....	327
PINZA PER TUMORI, YASARGIL.....	97
PINZA PERITONEALE, FAURE.....	123
PINZA PERITONEALE, MIKULICZ, 20CM.....	123
PINZA PERITONEALE, MIKULICZ-BABY.....	123
PINZA PERITONEALE, PHANEUF.....	123
PINZA PORTAPLACCHE, LANE.....	325
PINZA PORTAVITI, LANE.....	325
PINZA POSA CLIPS BIEMER.....	361,363,364,366
PINZA POSA CLIPS, MEHDORN.....	362
PINZA POSA CLIPS, RANEY.....	327
PINZA RENALE GUYON.....	122
PINZA SERRAPENE, STOCKMANN.....	553/1
PINZA SERRAPENE, STRAUSS.....	553/1
PINZA SERRATUBI.....	129
PINZA SERRATUBI, HOFFMANN.....	624
PINZA SERRATUBI, SIMPLEX.....	624
PINZA SERRATUBI, BULOW-GUNAR-HEY.....	130
PINZA SFENOIDALE HAJEK-KOFLER.....	430,431
PINZA SGORBIA BANE-HARTMANN.....	237
PINZA SGORBIA MAYFIELD.....	238
PINZA SGORBIA SMITH-PETERSEN.....	238
PINZA SGORBIA, ADSON.....	236
PINZA SGORBIA, BLUMENTHAL.....	236
PINZA SGORBIA, BOEHLER.....	238
PINZA SGORBIA, CLEVELAND.....	235
PINZA SGORBIA, ECHLIN.....	240
PINZA SGORBIA, FRIEDMAN-MICRO.....	234
PINZA SGORBIA, FRIEDMAN-MINI.....	234
PINZA SGORBIA, FRYKHOLM.....	240
PINZA SGORBIA, JANSEN.....	237
PINZA SGORBIA, KLEINERT-KUTZ.....	237
PINZA SGORBIA, LEMPERS.....	237
PINZA SGORBIA, LUER.....	236
PINZA SGORBIA, MARQUARDT.....	239
PINZA SGORBIA, MEAD.....	235
PINZA SGORBIA, OLIVECRONA.....	237
PINZA SGORBIA, RUSKIN.....	239
PINZA SGORBIA, SAUERBRUCH.....	240
PINZA SGORBIA, SCAGLIETTI.....	240
PINZA SGORBIA, SEMB.....	240
PINZA SGORBIA, STELLBRINK.....	234
PINZA SGORBIA, ZAUFAL-JANSEN.....	238
PINZA SGORBIA, LEKSELL-STILLE.....	240
PINZA SGORBIA, STILLE-LUER.....	239
PINZA SGORBIA, STILLE-RUSKIN.....	239
PINZA STOMACALE LANE.....	547
PINZA STRAPPAGESSI, WOLFF.....	233
PINZA TAGLIENTE CIRCOLARE.....	432
PINZA TAGLIENTE NASALE, KERRISON.....	428
PINZA TAGLIENTE PER CAPSULA, HOLTH.....	380
PINZA TAGLIENTE PER DISCHI INTERVERTEBRALI, COLCLOUGH.....	344/1
PINZA TAGLIENTE PER DISCHI INTERVERTEBRALI, FERRIS-SMITH-KERRISON.....	344, 344/2
PINZA TAGLIENTE PER LAMINECTOMIA, CLOWARD.....	342
PINZA TAGLIENTE PER LAMINECTOMIA, OLDBERG.....	341
PINZA TAGLIENTE PER LAMINECTOMIA, SCHLESINGER.....	342
PINZA TAGLIENTE PER LAMINECTOMIA, SPURLING.....	340
PINZA TAGLIENTE PER LAMINECTOMIA, WAGNER.....	343
PINZA TAGLIENTE PER LAMINECTOMIA, CUSHING.....	340
PINZA TAGLIENTE PER LAMINECTOMIA, FERRIS-SMITH.....	343
PINZA TAGLIENTE PER LAMINECTOMIA, LOVE-GRUENWALD.....	340
PINZA TAGLIENTE PER SETTO NASALE, CITELLI.....	430
PINZA TIRALINGUA, COLLIN.....	453
PINZA TIRALINGUA, YOUNG.....	453
PINZA TORCIFILI, BERRY TC.....	319
PINZA TORCIFILI, CORWIN-HEGAR TC.....	319
PINZA TORCIFILI, MAYO-HABERISSER TC.....	319
PINZA ULTRA LIGHT.....	95
PINZA UTERINA PER EMOSTASI, GREEN-ARMYTAGE.....	605
PINZA VASCOLARE BAINBRIDGE.....	495
PINZA VASCOLARE GLOVER.....	515
PINZA VASCOLARE, ADLERKREUTZ.....	84
PINZA VASCOLARE, DIEFFENBACH.....	104
PINZA VASCOLARE, LELAND-JONES.....	494
PINZA VASCOLARE, SATINSKY.....	491
PINZA VASCOLARE, STILLE-BARRAYA.....	88
PINZA, DAVIS.....	227
PINZE ATRAUMATICHE BULLDOG DE BAKEY.....	103
PINZE ATRAUMATICHE BULLDOG GLOVER.....	103
PINZE ATRAUMATICHE BULLDOG IN TITANIO.....	102
PINZE ATRAUMATICHE, DE BAKEY.....	98
PINZE PER SCHEGGIE.....	90
PIPER FORCIPE.....	604
PISTOLA LAVATRICE.....	626
PISTONI.....	258, 259
PISTONI CASPAR.....	258
PLACCA PER PALPEBRE JAEGER.....	371
PLACCA PER STENDIPELLE.....	49
PLESTER CANNULA D'ASPIRAZIONE.....	338
PLESTER COLTELLO.....	418
PLESTER DIVARICATORE.....	171
POLITIZER AGO PER PARACENTESI.....	408
POLITIZER COLTELLO AURICOLARE.....	408
POLITIZER INSOFFIATORE D'ARIA.....	406
POLITIZER OLIVA NASALE.....	406
POLITIZER SPECOLO AURICOLARE.....	399
POMPA D'ARIA.....	295
POOLE CANNULA D'ASPIRAZIONE.....	27
PORTA AGRAFES.....	326
PORTACOTONE, FARRELL.....	203
PORTACOTONE, JOBSON-HORNE.....	203
PORTACOTONE, REDA.....	203
PORTACOTONE, TOBOLD.....	203
PORTACOTONE, UCKERMANN.....	203
PORT'AGHI BARRAQUER.....	216, 217
PORT'AGHI CASTROVIEJO.....	216
PORT'AGHI MICROVASCULAR.....	210
PORT'AGHI, ADSON.....	211
PORT'AGHI, ARRUGA.....	214
PORT'AGHI, GORNER.....	208
PORT'AGHI, BARRAQUER-TROUTMAN.....	216
PORT'AGHI, BAUMGARTNER.....	208
PORT'AGHI, BOYNTON.....	214
PORT'AGHI, BOZEMANN.....	211
PORT'AGHI, BROWN.....	209
PORT'AGHI, CASTROVIEJO.....	215
PORT'AGHI, CASTROVIEJO MICRO.....	215
PORT'AGHI, COLLIER, 12,5CM.....	208
PORT'AGHI, CRILE.....	213
PORT'AGHI, CRILE-MURRAY.....	209
PORT'AGHI, CRILE-WOOD TC.....	209
PORT'AGHI, DE BAKEY.....	210
PORT'AGHI, DERF.....	208
PORT'AGHI, FINOCCHIETTO.....	211
PORT'AGHI, GILLIES.....	212
PORT'AGHI, HALSEY.....	208
PORT'AGHI, HALSEY.....	208
PORT'AGHI, HEANEY.....	210
PORT'AGHI, HOESEL.....	213
PORT'AGHI, JACOBSON.....	215
PORT'AGHI, JOHNSON.....	211
PORT'AGHI, KALT-ARRUGA.....	214
PORT'AGHI, KILNER.....	212
PORT'AGHI, LANGENBECK.....	213
PORT'AGHI, LICHTENBERG.....	213
PORT'AGHI, MASSON.....	210
PORT'AGHI, MATHIEU.....	213
PORT'AGHI, MATHIEU-OLSEN.....	212
PORT'AGHI, MAYO-HEGAR.....	209
PORT'AGHI, METZENBAUM.....	211
PORT'AGHI, NEIVERT.....	208
PORT'AGHI, OLSEN-HEGAR.....	212
PORT'AGHI, RYDER.....	210
PORT'AGHI, SAROT.....	211
PORT'AGHI, STEVENS.....	214
PORT'AGHI, WANGENSTEEN.....	210
PORT'AGHI, WEBSTER.....	208
PORT'AGHI, BABY-OLSEN-HEG.....	212
PORT'AGHI, STRATTE.....	212
PORTATORE DI LUCE FREDDA A FIBRE DI VETRO KLEINSASSER.....	36
POSA CLIPS.....	357, 358, 359, 360
POSA CLIPS JOHNS-HOPKINS.....	104
POSA CLIPS, MC KENZIE.....	326
POSA CLIPS, SMITHWICK.....	326
POSA CLIPS, SWEET.....	326
POST MORTEM AGO.....	268
POTTS PINZA PER COARTAZIONE E ANASTOMOSI .....	492, 493
POTTS SMITH PINZA CHIRURGICA.....	81
POTTS-DE MARTEL FORBICI VASCOLARI.....	59
POTTS-SMITH FORBICI VASCOLARI.....	61
POTTS-SMITH PINZA ANATOMICA.....	81
PRATT DILATATORE UTERINO.....	580
PRATT PINZA DA PRESA.....	110
PRATT PINZA PER ABBASSARE IL COLLO DELL'UTERO.....	584
PRATT SPECILO PER FISTOLE.....	563
PRATT SPECILO RETTALE.....	559
PRECISA SFGIMOMANOMETRO.....	9
PRICE-THOMAS PINZA PER BRONCHI.....	490
PRINCE FORBICI PER TONSILLE.....	59
PRINCE PINZA MUSCOLARE.....	387
PROTEGGIDITA, LANGENBECK.....	311
PROCTOSCOPO BENSANDE.....	565
PROCTOSCOPO MORGAN.....	565
PROCTOSCOPO, CHELSEA-EATON.....	563
PROCTOSCOPO, FANSLER.....	565
PROCTOSCOPO, KELLY.....	563
PROVIDENCE-HOSPITAL PINZA EMOSTATICA.....	106
PUNTE PER SPECILLI.....	201
PUTTI RASPA PER OSSA.....	294
Q QUERVAIN ELEVATORE.....	275
QUINBY FORBICI GINGIVALI.....	67
QUIRE LEVA PER CORPI ESTRANEI.....	412
QUISLING MARTELLO.....	271

R	ROBB SPATOLA.....	530	SCATOLA PER STERILIZZARE AGHI.....	615	
RACCORDO DI LAVAGGIO.....	626	ROBERTS PINZA EMOSTATICA.....	117	SCATOLA PER STRUMENTI.....	616, 617, 618
RACHOTOMO.....	267	ROCHARD DIVARICATORE ADDOMINALE.....	186	SCHAEDEL PINZA FISSATELI.....	132
RADOLF PINZA PER LACERAZIONE UNGHIE.....	297	ROCHARD SUPPORTO.....	186	SCHAMBERG SCHIACCIACCOMEDONI.....	608
RAGNELL DIVARICATORE.....	140	ROCHESTER-CARMALT.....	109	SCHEDA CURETTA TAGLIANTE.....	251
RALK PERFORATORE A MANO.....	300	ROCHESTER-OCHSNER PINZA EMOSTATICA.....	108	SCHEIE COLTELLO PER GONIOTOMIA.....	373
RAMPLEY PINZA PER MEDICATURA.....	136	ROCHESTER-PEAN PINZA EMOSTATICA.....	108	SCHHEIMANN INSERTO.....	472
RAMUS DIVARICATORE.....	461	ROEDER PINZA FISSATELI.....	132	SCHERBAK SPECOLO VAGINALE.....	575
RANDALL CURETTA PER BIOPSIA.....	587	ROGER ELEVATORE PER SETTO.....	437, 438	SCHIACCIACCOMEDONI, SAALFELD.....	608
RANDALL PINZA PER CALCOLI RENALI.....	535	ROGERS PINZA PER ISTERECTOMIA.....	127	SCHIACCIACCOMEDONI, SCHAMBERG.....	608
RANEY GRAFFA PER IL CUIOIO CAPELLUTO.....	327	ROGGE PINZA PER STERILIZZAZIONE.....	227	SCHIACCIACCOMEDONI, UNNA.....	608
RANEY PINZA POSA CLIPS.....	327	ROLLET SCALPELLO ESTIRPATORE.....	374	SCHIACCIACCOMEDONI, WALTON.....	608
RASCHIATOIO CORNEALE, KUHN.....	373	ROLLET UNCINO DIVARICATORE.....	375	SCHIACCIATORE PER L'INTESTINO E LO STOMACO, PAYR.....	548
RASOIO.....	49	ROMPILAMETTE, CASTROVIEJO.....	45	SCHIMMELBUSCH TAMBURO.....	622
RASPA NASALE FOMON TC.....	445	ROMPILAMETTE, REDA.....	45	SCHINK DERMATO.....	49
RASPA NASALE GALLAHER.....	446	ROMPILAMETTE, TROUTMAN-CHRIS.....	45	SCHIOETZ TONOMETRO.....	394/2
RASPA NASALE MILLER.....	444	ROSE DIVARICATORE.....	140	SCHLESINGER PINZA TAGLIANTE PER LAMINECTOMIA.....	342
RASPA NASALE PEET.....	446	ROSEN AGO.....	419	SCHMEDEN PINZA NASALE.....	427
RASPA NASALE.....	444	ROSEN CANNULA D'ASPIRAZIONE.....	338	SCHMID CANNULA PER IRRIGAZIONE.....	338
RASPA NASALE, JOSEPH.....	443	ROSEN COLTELLO.....	418	SCHMIEDEN SPECILLO DI GUIDA SCANALATO.....	221
RASPA NASALE, JOSEPH (LEWIS).....	443	ROSER-KOENIG APRIBOCCA.....	454	SCHMIEDEN-DICK AGO PER LEGATURE.....	219
RASPA NASALE, MALTZ.....	443	ROTATORE PER NUCLEO BECHERT.....	379	SCHMIEDEN-TAYLOR FORBICI PER DURAMADRE.....	65/1
RASPA NASALE, MALTZ (COTTLE).....	444	ROUX MINI DIVARICATORE.....	140	SCHNIDT PINZA PER TONSILLE.....	467
RASPA NASALE, WIENER.....	443	ROUX DIVARICATORE.....	139	SCHOENBORN DIVARICATORE PER TIROIDE.....	479
RASPA PER OSSA.....	294	ROUX-BABY DIVARICATORE.....	140	SCHRÖDER CUCCHIAIO UTERINO.....	595
RASPA PER OSSA PUTTI.....	294	ROWE PINZA PER RIPOSIZIONE.....	459	SCHROEDER(POZZI) PINZA PER ABBASSARE IL COLLO DELL'UTERO.....	582
RECAMIER CURETTE UTERINI.....	597	RUBIN OSTEOTOMO PER SETTO.....	440	SCHUBERT PINZA PER BIOPSIA.....	588
RECIPIENTE CILINDRICO.....	620	RUBIN PINZA PER SETTO NASALE.....	428	SCHUKNECHT COLTELLO.....	418
REDA DIAPASON.....	403	RUDD LEGATORE EMORROIDALE.....	568	SCHULTZE SALPINGOGRAFO.....	596
REDA CALAMITA OCULISTICA.....	395	RUMEL PINZA EMOSTATICA.....	117	SCHULZE-BERGMANN SPECOLO RETTALE.....	560
REDA COLTELLO FALCATO.....	435	RUMEL-BELMONT TOURNIQUET.....	528	SCHUMACHER FORBICI PER STERNO.....	481
REDA COLTELLO PER AMPUTAZIONE.....	44	RUSKIN PINZA SGORBIA.....	239	SCHUMACHER INSERTO.....	472
REDA CURETTA TAGLIANTE.....	256	RUSKIN-LISTON CESOIA PER OSSA.....	241	SCHUMACHER PINZA PER BIOPSIA.....	588, 589
REDA DIVARICATORE PER GESSI.....	232	RUSSEL-DAVIS ABBASSALINGUA.....	458	SCHWEIGGER PINZA CAPSULARE.....	391
REDA EXCENTER FORBICI PER BENDAGGI.....	69/2	RYDEL-SEIFFERT DIAPASON.....	404	SCLEROTOMO, GUYTON-LUNDSGAARD.....	373
REDA PERFORATORE A MANO.....	300	RYDER PORT'AGHI.....	210	SCLEROTOMO, LUNDGAARD.....	373
REDA PINZA COPERCHIO.....	615	S		SCOVILLE CURETTA TAGLIANTE.....	253
REDA PINZA DEPILETORIA.....	395	SAALFELD SCHIACCIACCOMEDONI.....	608	SCOVILLE DIVARICATORE PER LAMINECTOMIA.....	196
REDA PINZA PER AFFERRARE INTESTINI.....	111	SACHS DURA DISSETTORE.....	332	SCOVILLE UNCINI PER RADICI DEI NERVI.....	330
REDA PORTACOTONE.....	203	SACHS UNCINO PER NERVI.....	329	SCOVILLE VALVE.....	196
REDA ROMPILAMETTE.....	45	SAENGER PINZA PER ABORTO.....	606	SCOVILLE-HAVERFIELD DIVARICATORE PER LAMINECTOMIA.....	196
REDA SEGA TAGLIA ANELLI.....	297	SALPINGOGRAFO.SCHULTZE.....	596	SCUDDER PINZA INTESTINALE.....	541
REDA SONDA CONDUTTRICE A FORCHETTA.....	221	SANVENERO FORBICI PER CHIRURGIA.....	54	SEBILEAU ELEVATORE.....	275
REDA SPECOLO NASALE.....	423	SAROT PINZA EMOSTATICA.....	118	SEDILLOTT PERIOSTOTOMO.....	274, 275
REDA UNCINO PER LA PELLE.....	150	SAROT PORT'AGHI.....	211	SEGA, GIGLI.....	332
REDON AGO DI GUIDA.....	207	SATINSKY FORBICI VASCOLARI.....	65/2	SEGA ELETTRICA PER GESSI.....	230
REES FACE LIFT FORBICI.....	73	SATINSKY PINZA VASCOLARE.....	491	SEGA IN FILO D'ACCIAIO, OLIVECRONA.....	332
REGOLO DI METALLO.....	25	SATO DISSETTORE CORNEALE.....	373	SEGA NASALE, JOSEPH.....	446
REICHERT DEPRESSORE PER EPIGLOTTIDE.....	471	SATTERLEE SEGA PER AMPUTAZIONE.....	296	SEGA OSCILLANTE PER GESSI CON ASPIRAZIONE.....	231
REILL TENAGLIA PER OSSA.....	248	SAUERBRUCH COSTOTOMO.....	481	SEGA PER AMPUTAZIONE BIER.....	296
REINER COLTELLO PER GESSI.....	233	SAUERBRUCH DIVARICATORE.....	164	SEGA PER AMPUTAZIONE, CHARRIERE.....	296
REINER SIRINGA AURICOLARE.....	406	SAUERBRUCH DIVARICATORE.....	166	SEGA PER AMPUTAZIONE, SATTERLEE.....	296
RESANO PINZA INTESTINALE.....	542	SAUERBRUCH PINZA PER RIFIUTI.....	227	SEGA PER AUTOPSIA.....	231/1
RESANO, FORBICI PER CAPSULA.....	53/2	SAUERBRUCH PINZA SGORBIA.....	240	SEGA PER DITA, LANGENBECK.....	296
RETRATTORE, PERCY.....	296	SAUERBRUCH-FREY COSTOTOMO.....	481	SEGA PER GESSI, ENGEL.....	229
RETRATTORI INTRAORALI.....	463/1	SAWTELL PINZA PER TONSILLE.....	467	SEGA TAGLIA ANELLI, REDA.....	297
RETRATTORI INTRAORALI.....	463/4	SAWYER SPECOLO RETTALE.....	560	SEGA TAGLIA ANELLI, WALTON.....	297
REVERDIN AGO.....	220	SAYRE ELEVATORE.....	281	SEGOND BISTURI PER FIBROMI.....	594
REVERDIN SPATOLA ADDOMINALE E INTESTINALE.....	143/1	SCAGLIETTI PINZA SGORBIA.....	240	SEGOND PINZA PER ISTERECTOMIA.....	125
REYNOLDS FORBICI PER CHIRURGIA.....	54	SCALP-CONTOUR DIVARICATORE.....	169	SEGOND-LANDAU PINZA PER ISTERECTOMIA.....	125
REYNOLDS SUPERCUT FORBICI.....	72	SCALPELLI.....	259	SEIFERT INSERTO.....	472
RIBBON SPATOLA ADDOMINALE E INTESTINALE.....	143	SCALPELLO ESTIRPATORE, ROLLET.....	374	SELDIN PERIOSTOTOMO.....	277
RICARD DIVARICATORE ADDOMINALE.....	191	SCALPELLO PARTSCH.....	259	SELLHEIM CUCCHIAIO OSTETRICO.....	607
RICHARDSON DIVARICATORE.....	142	SCALPELLO PER SETTO, CINELLI.....	441	SEMB CESOIA PER OSSA.....	242
RICHARDSON-EASTMAN DIVARICATORE.....	142	SCALPELLO PER SETTO, COTTLE.....	440	SEMB PERIOSTOTOMO.....	278
RICHARDSON-GRIP DIVARICATORE.....	142	SCALPELLO PER SETTO, FREER.....	439	SEMB PINZA PER BRONCHI.....	491
RICHNAU-HOLMGREN SPECOLO AURICOLARE.....	400	SCALPELLO PER SETTO, SILVER.....	442	SEMB PINZA SGORBIA.....	240
RICHTER-HEATH PINZA PER AGRAFES.....	224	SCALPELLO, ALEXANDER.....	259	SEMB TENAGLIA PER OSSA.....	243
RIENHÖFF-FINOCHIETTO DIVARICATORE COSTALE.....	486	SCALPELLO, BRUNETTI.....	268	SEMKEN PINZA ANATOMICA.....	86
RIGBY DIVARICATORE ADDOMINALE.....	189/2	SCALPELLO, HIBBS.....	265		
RI-MINI COMBINAZIONE PER DIAGNOSTICA CON ILLUMINAZIONE ALOGENA.....	17	SCALPELLO, STILLE.....	260		
RITTER-HALLE DILATORE PER SENO FRONTALE.....	433	SCATOLA PER STERILIZZARE AGHI.....	615		

SEMKEN PINZA CHIRURGICA.....	86	SINGLEY PINZA PER AFFERRARE TESSUTI.....	88	SPECILLO DI GUIDA SCANALATO, SCHMIEDEN.....	221
SEMM SPECOLO VAGINALE.....	571	SINSKEY UNCINO.....	376	SPECILLO DI GUIDA, VIENNA.....	221
SENN-GREEN DIVARICATORE.....	153	SINUS ELEVATORE PER SETTO.....	438	SPECILLO FOGLIA MIRTE.....	199
SENN-MILLER DIVARICATORE.....	143	SIRINGA AURICOLARE.....	407	SPECILLO PER CANALE LACRIMALE BOWMAN.....	381
SEPERATORE PER IL CORPO MANDIBOLARE HARGIS.....	463/6	SIRINGA AURICOLARE, REINER.....	406	SPECILLO PER FISTOLE LOCKHART-MUMMERY.....	200
SEPERATORI SAGITTALI SMITH.....	463/5	SIRINGA PER TONSILLE.....	470	SPECILLO PER FISTOLE, PRATT.....	563
SEPTEMZANGE KNIGHT.....	425	SISTEMA DI FISSAGGIO, LEYLA.....	368, 368/1, 368/2, 368/3, 368/4	SPECILLO SCANALATO.....	199
SERPENTINE PINZA PER BIOPSIA.....	593	SISTEMA RETRATTORE.....	188	SPECILLO SCANALATO, BRODIE.....	199
SERRANODI KRAUSE.....	433/2	SKENA PINZA PER ABBASSARE IL COLLO.....	582	SPECILLO SCANALATO, DOYEN.....	199
SERRANODI KRAUSE-VOSS.....	433/2	DELL'UTERO.....	582	SPECILLO SCANALATO, NELATON.....	199
SERRANODI PER TONSILLE, BRUENINGS.....	468	SLS PINZA APPLICATORE CLIPS MICRO.....	524, 525	SPECILLO, FISH.....	199
SERRANODI PER TONSILLE, EVES.....	468	SLUDER-BALLENGER TONSILLOTOMO.....	470	SPECILLO, WATSON-CHAYNE.....	199
SERRANODI RETTALE, WESTON.....	566	SMELLIE PERFORATORE.....	607	SPECILO AURICOLARE RICHAU-HOLMGREN.....	400
SERRANODI WILDE.....	433/2	SMELLIE UNCINO.....	605	SPECILO AURICOLARE, BOUCHERON.....	399
SET LARINGOSCOPIO FOREGGER.....	31	SMILLIE COLTELLO PER MENISCO.....	292	SPECILO AURICOLARE, BRUENINGS.....	401
SET LARINGOSCOPIO MC INTOSH.....	31	SMILLIE ELEVATORE PER OSSA.....	291	SPECILO AURICOLARE, GRUBER.....	399
SET PER INFERMERIA.....	609	SMITH BLEFAROSTATO.....	370	SPECILO AURICOLARE, HARTMANN.....	399
SET PER SUTURA IN ASTUCCIO DI METALLO.....	225, 226	SMITH SEPARATORI SAGITTALI.....	463/5	SPECILO AURICOLARE, POLITZER.....	399
SET PER TRACHEOTOMIA.....	478	SMITH US ARMY FORBICI PER BENDAGGI.....	69/1	SPECILO AURICOLARE, SIEGLE.....	402
SET PER VARICI IN SCATOLA DI METALLO, NABATOFF.....	201	SMITH-BUIE DIVARICATORE ANALE.....	561	SPECILO AURICOLARE, TOYNBEE.....	399
SEUTIN FORBICI PER BENDAGGI.....	69/2	SMITH-PETERSEN OSTEOTOMO.....	261	SPECILO LATERALE.....	569
SEXTON COLTELLO AURICOLARE.....	408	SMITH-PETERSEN OSTEOTOMO.....	261	SPECILO NASALE HARTMANN.....	422
SFIGMOMANOMETRO, BABYPHON.....	10	SMITH-PETERSEN PINZA SGORBIA.....	238	SPECILO NASALE REDA.....	423
SFIGMOMANOMETRO, DIPLOMAT.....	5	SMITHWICK PINZA POSA CLIPS.....	326	SPECILO NASALE, COTTLE.....	423
SFIGMOMANOMETRO, EXACTA.....	8	SMITHWICK UNCINO PER NERVI.....	329	SPECILO NASALE, HARTMANN-HALLE.....	421
SFIGMOMANOMETRO, MINIMUS II.....	11	SNELLEN ANSA PER CATERATA.....	378	SPECILO NASALE, KILLIAN.....	423
SFIGMOMANOMETRO, MINIMUS III.....	12	SNELLEN PINZA PER ROVECIARE PALPEBRE.....	393	SPECILO NASALE, MOD.VIENNA.....	421
SFIGMOMANOMETRO, NOVA.....	6.7	SOMER PINZA PER AFFERRARE L'UTERO.....	585	SPECILO NASALE, THUDICHUM.....	421
SFIGMOMANOMETRO, PRECISA.....	9	SONDA BOTTUNUTA, JACOBSON.....	335	SPECILO NASALE, TIECK-HALLE.....	423
SGORBIA.....	264	SONDA CONDUTTRICE A FORCHETTA.....	475	SPECILO NASALE, VOLTOLINI.....	421
SGORBIA, PARTSCH.....	259	SONDA CONDUTTRICE A FORCHETTA REDA.....	221	SPECILO RETTALE HILL-FERGUSON.....	560
SGORBIA ALEXANDER.....	259	SONDA PER CALCOLI BILIARI DESJARDINS.....	532	SPECILO RETTALE SAWYER.....	560
SGORBIA BRÜNNINGS-LUCAS.....	260	SONDA PER CALCOLI BILIARI MOYNIHAN.....	532	SPECILO RETTALE, ALAN-PARKS.....	561
SGORBIA KILLIAN.....	442/1	SONDA PER CALCOLI BILIARI, MAYO.....	534	SPECILO RETTALE, BARR.....	559
SGORBIA PER CORPI ESTRANEI, DIX.....	374	SONDA PER GOZZO, KOCHER.....	479	SPECILO RETTALE, BODENHAMMER.....	559
SGORBIA PER CORPI ESTRANEI, ELLIS.....	374	SONDA, WORST.....	381	SPECILO RETTALE, CZERNY.....	559
SGORBIA PER CORPI ESTRANEI, WALTON.....	374	SONDA, WORST.....	381	SPECILO RETTALE, MATHIEU.....	560
SGORBIA PER SETTO FREER.....	442/1	SPATOLA ADDOMINALE.....	144	SPECILO RETTALE, PRATT.....	559
SGORBIA PER SETTO, HAJEK.....	442/1	SPATOLA ADDOMINALE E INTESTINALE LERICHE.....	143/2	SPECILO RETTALE, SIMS.....	559
SGORBIA PER SETTO, KILLIAN-CLAUS.....	442/1	SPATOLA ADDOMINALE E INTESTINALE, HABERER.....	143/1	SPECILO RETTALE, SCHULZE-BERG.....	560
SGORBIA PER SETTO, WEST.....	442/1	SPATOLA ADDOMINALE E INTESTINALE, REVERDIN.....	143/1	SPECILO VAGINALE, JACKSON.....	573
SGORBIA, COBB.....	262	SPATOLA ADDOMINALE E INTESTINALE, RIBBON.....	143	SPECILO VAGINALE, AUJARD.....	576
SGORBIA, HIBBS.....	265	SPATOLA ADDOMINALE ED INTESTINALE KADER.....	143/1	SPECILO VAGINALE, BREISKY.....	577
SGORBIA, LEXER MINI.....	263	SPATOLA ADDOMINALE ED INTESTINALE KÖRTE.....	143/1	SPECILO VAGINALE, COLLIN.....	570
SGORBIA, ZIELKE.....	264	SPATOLA ADDOMINALE ED INTESTINALE KÜMMLER.....	143/2	SPECILO VAGINALE, CUSCO.....	570, 571
SGORBIA, STILLE.....	260	SPATOLA CEREBRALE CUSHING.....	369	SPECILO VAGINALE, DOYEN.....	574
SGORBIE.....	259	SPATOLA CEREBRALE DAVIS.....	337	SPECILO VAGINALE, FRIEDMANN.....	577
SHAMBAUGH UNCINO.....	419	SPATOLA CEREBRALE HEIFETZ.....	369	SPECILO VAGINALE, LANDAU.....	570
SHAPLEIGH ANSA AURICOLARE.....	410	SPATOLA CEREBRALE, CUSHING.....	336	SPECILO VAGINALE, KALLMORGEN.....	573
SHEA MICRO FORBICI AURICOLARI.....	413	SPATOLA CEREBRALE, OLIVECRONA.....	336	SPECILO VAGINALE, KRISTELLER.....	572
SHEEHAN OSTEOTOMO PER SETTO.....	441	SPATOLA PER CICLODIALISI HIRSCHMAN.....	379	SPECILO VAGINALE, LANDAU.....	577
SHEETS CANNULA PER IRRIGAZIONE.....	394/2	SPATOLA PER CICLODIALISI, BANGERTER.....	379	SPECILO VAGINALE, O'SULLIVAN-O'CONNOR.....	576
SIEBENMANN CANNULA PER IRRIGAZIONE.....	433	SPATOLA PER CICLODIALISI, ELSCHNIG.....	379	SPECILO VAGINALE, PEDERSON.....	570
SIEBOLD FORBICI GINECOLOGICHE.....	62	SPATOLA PER CICLODIALISI, WHEELER.....	379	SPECILO VAGINALE, SEMM.....	571
SIEGLE SPECOLO AURICOLARE.....	402	SPATOLA PER CICLODIALISI, CASTROVIEJO.....	379	SPECILO VAGINALE, SIMS.....	573
SILVER DERMATOMO.....	50	SPATOLA PER IRIDE, CULLER.....	378	SPECILO VAGINALE, TRELAT.....	571
SILVER SCALPELLO PER SETTO.....	442	SPATOLA PER IRIDE, WECKER.....	378	SPECILO VAGINALE, VU-MORE.....	569
SIMCOE CANNULA PER IRRIGAZIONE.....	394	SPATOLA PER PEDICURE.....	612	SPECILO VAGINALE, SCHERBAK.....	575
SIMON CUCCHIAIO UTERINO.....	594	SPATOLA PER POLMONE, ALLISON.....	489	SPENCER FORBICI PER LEGATURE.....	66
SIMON DIVARICATORE.....	164	SPATOLA ROBB.....	530	SPENCER-WELLS PINZA EMOSTATICA.....	109
SIMPLEX PINZA SERRATUBI.....	624	SPATOLA VESCICALE, KOCHER.....	552	SPIZZATORE UNGHIE.....	612/1
SIMPSON FORCIPE.....	602	SPATOLA VESCICALE, LEGUEU.....	552	SPILLONE PER STERILIZZAZIONE, BUNT.....	227
SIMPSON-BRAUN FORCIPE.....	602	SPAZZOLA PER UNGHIE.....	611	SPILLONE PER STERILIZZAZIONE, MAYO.....	227
SIMPSON-LUIJKART FORCIPE.....	603	SPECCHIO FRONTALE ZIEGLER.....	21	SPINAL CURETTA TAGLIANTE.....	253
SIMS CURETTE UTERINI.....	597, 598	SPECCHIO LARINGEO.....	473	SPINA-NASALIS DIVARICATORE.....	461
SIMS DEPRESSORE UTERINO.....	586	SPECCHIO LARINGEO, MICHEL.....	423	SPRATT CURETTA TAGLIANTE.....	251
SIMS DILATATORE UTERINO.....	581	SPECILLO AURICALE, STACKE.....	199	SPURLING PINZA TAGLIANTE PER LAMINECTOMIA.....	340
SIMS FORBICI GINECOLOGICHE.....	62	SPECILLO DI GUIDA SCANALATO KÖNIG.....	221	SPUTACCHIERA.....	621
SIMS ISTEROMETRO.....	586	SPECILLO DI GUIDA SCANALATO BRUNNER.....	221	ST..CLAIR-THOMSON COLTELLO ADENOIDE.....	450
SIMS SPECOLO RETTALE.....	559	SPECILLO DI GUIDA SCANALATO KIRSCHNER.....	221	ST.MARKS DIVARICATORE PELVICO.....	165
SIMS SPECOLO VAGINALE.....	573	SPECILLO DI GUIDA SCANALATO SCHMIEDEN-PAYR.....	221	ST.MARTIN PINZA PER SUTURA.....	392
SIMS-MAIER PINZA PER MEDICATURA.....	134	SPECILLO DI GUIDA SCANALATO, BRUNNER.....	221	STACKE SPECILO AURICALE.....	199
		SPECILLO DI GUIDA SCANALATO, PAYR.....	221	STANDARD FORBICI PER CHIRURGIA.....	51

STAUDE-MOORE PINZA PER ABBASSARE IL COLLO DELL'UTERO .....	582	T	TABB COLTELLO .....	418	TOWNSEND MANICO SOLO .....	591
STEINMANN CHIODI .....	307, 308		TAKAHASHI PINZA NASALE .....	427	TOYNBEE SPECOLO AURICOLARE .....	399
STEINMANN PINZA PER AFFERRARE TENDINI .....	292		TAMBURO, SCHIMMELBUSCH .....	622	TRASFORMATORE RICARICA BATTERIA .....	34
STELLBRINK PINZA SGORBIA .....	234		TAMPONATORE ,LUNJATSCHK .....	465	TRATTORE, BARTON .....	603
STERNBERG DIVARICATORE PER GUANCE .....	453		TARNIER CRANIOCLASTO .....	607	TRATTORE, BILL .....	604
SCALPELLO PER STERNO, LEBSCHKE .....	267		TARNIER FORCIPE .....	604	TRATTORE, LUIKART-BILL .....	604
STETOSCOPIO, ANESTOPHON .....	23		TAYLOR - USA MARTELLO DA PERCUSSIONE .....	24	TRAVERSI DIVARICATORE .....	172
STETOSCOPIO, DUPLEX .....	23		TAYLOR DIVARICATORE SPINALE .....	291	TREFINA CUTANEA, KEYES .....	608
STETOSCOPIO, PINARD .....	23		TAYLOR PINZA CHIRURGICA .....	87	TRELAT SPECOLO VAGINALE .....	571
STETOSCOPIO .....	23		TC FORBICI PER CHIRURGIA FINE, REYNOLDS TC .....	54	TREQUARTO PER SENO MASCELLARE, COAKLEY .....	204
STEVENS FORBICI PER OFTALMOLOGIA .....	58		TC FORBICI PER CHIRURGIA STANDARD .....	51	TREQUARTO PER SENO MASCELLARE, PIERCE .....	204
STEVENS PINZA PER IRIDE .....	383		TC PINZA ANATOMICA .....	81	TREQUARTO PER SINOSCOPIA .....	205
STEVENS PORT'AGHI .....	214		TC PINZA CHIRURGICA .....	81	TREQUARTO PER SINOSCOPIA .....	205
STEVENS SUPERCUT FORBICI .....	72		TC PINZA CUSHING .....	83	TREQUARTO, NELSON .....	205
STEVENS UNCINO PER TENOTOMIA .....	375		TC PINZA CUSHING TAYLOR .....	87	TREQUARTO, OCHSNER .....	205
STEVENSON BLEFAROSTATO .....	371		TC PINZA GILLIES .....	86	TREQUARTO, UNIVERSAL .....	204
STIEGLITZ PINZA PER SCHEGGE .....	92		TC PINZA SEMKEN .....	86	TREQUARTO, STANDARD (NELSON) .....	204
STILLE CESOIA PER IRIDE .....	229		TC PINZA WANGENSTEEN .....	89	TROELTSCH PINZA AURICOLARE .....	424
STILLE COSTOTOMO .....	480		TEALE PINZA PER ABBASSARE IL COLLO DELL'UTERO .....	583	TROEMNER PERKUSSIONSMARTELLO .....	24
STILLE OSTEOTOMO .....	260		TEBBETS DIVARICATORE PER CHIRURGIA PLASTICA .....	197	TRONCHESINA PER PELLE .....	610
STILLE PERFORATORE A MANO .....	298		TELAIO PIEGABILE KIRSCHNER .....	187	TRONCHESINA PER UNGHIE .....	612/1, 613
STILLE PINZA ANATOMICA .....	81		TENAGLIA PER OSSA .....	247	TRONCHESINA PER UNGHIE ANVIL .....	613
STILLE PINZA CHIRURGICA .....	81/1		TENAGLIA PER OSSA .....	249	TRONCHESINA PER UNGHIE, TURNBULL .....	609
STILLE PINZA EMOSTATICA .....	122		TENAGLIA PER OSSA BIRCHER-GANSKE .....	246	TROUSSEAU DILATATORE TRACHEALE .....	476
STILLE SCALPELLO .....	260		TENAGLIA PER OSSA, ADSON .....	298	TROUSSEAU-BABY DILATATORE TRACHEALE .....	476
STILLE SGORBIA .....	260		TENAGLIA PER OSSA, DINGMANN .....	246	TROUTMAN PINZA PER IRIDE .....	389
STILLE-BARRAYA PINZA VASCOLARE .....	88		TENAGLIA PER OSSA, FARABEUF .....	243	TROUTMAN-CHRIS ROMPILAMETTE .....	45
STILLE-HORSLEY CESOIA PER OSSA .....	242		TENAGLIA PER OSSA, FARABEUF-L .....	243	TUBBS DILATATORE .....	528
STILLE-LISTON CESOIA PER OSSA .....	242		TENAGLIA PER OSSA, FERGUSSON .....	243	TÜBINGEN PINZA PER FILO .....	392
STILLE-LUER PINZA SGORBIA .....	239		TENAGLIA PER OSSA, KERN .....	244	TUBO DI PROLUNGAMENTO, BRUENINGS .....	472
STILLE-RUSKIN PINZA SGORBIA .....	239		TENAGLIA PER OSSA, LAMBOTTE .....	244	TUFFIER DIVARICATORE .....	147
STILLE-SHERMAN PERFORATORE A MANO .....	298		TENAGLIA PER OSSA, LANE .....	244	TUFFIER DIVARICATORE COSTALE .....	487
STOCKMANN PINZA SERRAPENE .....	553/1		TENAGLIA PER OSSA, LANGENBECK .....	243	TUFFIER PINZA PER AFFERRARE TESSUTI .....	110
STONE-WATT COMPRESSORE .....	545		TENAGLIA PER OSSA, LEWIN .....	246	TURNBULL TRONCHESINA PER UNGHIE .....	609
STRANDELL-STILLE DIVARICATORE .....	157		TENAGLIA PER OSSA, REILL .....	248	TURREL PINZA INTESTINALE PER BIOPSIA .....	567
STRATTE PORT'AGHI .....	212		TENAGLIA PER OSSA, SEMB .....	243	TYDING PINZA PER TONSILLE .....	467, 468
STRAUSS PINZA SERRAPENE .....	553/1		TENAGLIA PER OSSA, ULRICH .....	248	TYDING TONSILLOTOMO .....	469
STRUEMPEL PINZA PER CORPI ESTRANEI .....	412		TENAGLIA PER OSSA, VAN BUREN .....	249		
STRULLY FORBICI PER NEUROCHIRURGIA .....	65		TENAGLIA PER OSSA, VERBRUGGE .....	245	U	
STRUMENTI PER CORPI ESTRANEI, DIX .....	380		TENAGLIE TAGLIAFILII .....	317, 318	UCKERMANN PORTACOTONE .....	203
STRUMENTO PER CIRCONCISIONE .....	556		TERSON PINZA CAPSULARE .....	391	ULRICH PINZA PER MEDICATURA .....	135
STRUMENTO PER MISURE .....	594		TESSIER DIVARICATORE .....	463/3	ULRICH TENAGLIA PER OSSA .....	248
STRUMENTO PER VARICI VARADY .....	202		THOMAS CURETTE UTERINI .....	599	ULTRA-LIGHT-PINZA, ATTRAUMATICA .....	95
STRUMENTO TENDIFILI, DEMEL .....	315		THOMAS-GAYLOR PINZA PER BIOPSIA .....	588	UNCINO ACUTO LAHEY .....	149
STRUMENTO TENDIFILI, LOUTE .....	315		THOMS-ALLIS PINZA PER AFFERRARE INTESTINI .....	538	UNCINO DI FISSAZIONE, BURCH .....	373
STRUYCKEN PINZA NASALE .....	427		THOMSON-WALKER DIVARICATORE VESCICALE .....	552	UNCINO DIVARICATORE, KNAPP .....	375
STUOIA IN SILICONE .....	616		THOREK, FORBICI TORACALI .....	65/2	UNCINO DIVARICATORE, ROLLET .....	375
SUBRAMANIAN-MINIATURE PINZA PER AORTA PEDRIATICA .....	521		THUDICHUM SPECOLO NASALE .....	421	UNCINO ESTRATTORE .....	322
SUPERCUT FORBICI .....	71		TIECK-HALLE SPECOLO NASALE .....	423	UNCINO ESTRATTORE, ARRUGA .....	375
SUPERCUT FORBICI IRIS .....	72		TIRLEY PINZA AURICOLARE .....	411	UNCINO GALEA, YASARGIL .....	330
SUPERCUT FORBICI KILNER .....	72		TILAMIONI, DOYEN .....	594	UNCINO GASS .....	376
SUPERCUT FORBICI LISTER .....	72		TRAVENE .....	202	UNCINO KUGLEN .....	376
SUPERCUT FORBICI REYNOLDS .....	72		TISCHLER PINZA PER BIOPSIA .....	591	UNCINO NASALE AUFRICHT .....	447
SUPERCUT FORBICI STEVENS .....	72		TISCHLER-KEVORKIAN PINZA PER BIOPSIA .....	592	UNCINO NASALE CONVERSE .....	448
SUPERCUT FORBICI WAGNER .....	72		TISCHLER-MORGAN PINZA PER BIOPSIA .....	590, 591	UNCINO NASALE UNCINO .....	447
SUPERCUTFORBICI MAYO .....	71		TITAN PINZA EMOSTATICA, CRILLE .....	107	UNCINO NASALE, COTTLE .....	447
SUPERCUTFORBICI MAYO-STILLE .....	71		TITAN PINZA EMOSTATICA, KELLY .....	106	UNCINO NASALE, MASING-NEIVERT .....	447
SUPERCUTFORBICI METZENBAUM .....	71		TOBOLD ABBASSALINGUA .....	453	UNCINO PER DURA MADRE, JACOBSON .....	335
SUPERCUTFORBICI, BABY METZENBAUM .....	71		TOBOLD PORTACOTONE .....	203	UNCINO PER DURAMADRE .....	335
SUPPORTO PER PETTO NEGUS .....	459		TOENNIS DURA DISSETTORE .....	332	UNCINO PER DURAMADRE, ADSON .....	329
SUPPORTO PER STERILIZZAZIONE FILI KIRSCHNER .....	305		TOENNIS PINZA EMOSTATICA .....	117	UNCINO PER FISTOLE, EMMETT .....	594
SUPPORTO PER TUBO .....	188		TOENNIS-ADSON FORBICI PER NEUROCHIRURGIA .....	65	UNCINO PER IL STRABISMO, GRAEFE .....	375
SUPPORTO UNIVERSALE PER DIVARICATORI .....	188		TOGLILAMA .....	42	UNCINO PER IL STRABISMO, GREEN .....	375
SUPPORTO UNIVERSALE PER ENDOSCOPIO .....	188		TOHUKU PINZA FISSATELI .....	132	UNCINO PER IL STRABISMO, JAMESON .....	375
SUPPORTO, ROCHARD .....	186		TONOMETRO, SCHIOETZ .....	394/2	UNCINO PER IRIDE, O'CONNOR .....	375
SWEET PINZA POSA CLIPS .....	326		TONSILLOTOMO, SLUDER-BALLENGER .....	470	UNCINO PER IRIDE, WIENER .....	375
SYSTRUNK FORBICI PER CHIRURGIA .....	66		TONSILLOTOMO, TYDING .....	469	UNCINO PER LA PELLE GRAEFE .....	149
			TOOK DISSETTORE CORNEALE .....	373	UNCINO PER LA PELLE, COTTLE-NEIVERT .....	448
			TOURNIQUET RUMEL-BELMONT .....	528	UNCINO PER LA PELLE, FOMON .....	447/1
			TOWNSEND PINZA PER BIOPSIA .....	591	UNCINO PER LA PELLE, FRAZIER .....	149
					UNCINO PER LA PELLE, FREER .....	448
					UNCINO PER LA PELLE, GILLIES .....	448

UNCINO PER LA PELLE, GUTHRIE.....	149
UNCINO PER LA PELLE, JOSEPH.....	149
UNCINO PER LA PELLE, KILNER.....	608
UNCINO PER LA PELLE, KLEINERT-KUTZ.....	149
UNCINO PER LA PELLE, REDA.....	150
UNCINO PER LE PINNE NASALI LANGE.....	448
UNCINO PER MUSCOLI.....	267
UNCINO PER NERVI D'ERRICO.....	329/2
UNCINO PER NERVI, CRILE.....	328
UNCINO PER NERVI, CUSHING.....	328
UNCINO PER NERVI, DANDY.....	328
UNCINO PER NERVI, GRAHAM.....	329
UNCINO PER NERVI, HESS.....	329/1
UNCINO PER NERVI, KRAYENBUEHL.....	336
UNCINO PER NERVI, LOVE.....	329/2
UNCINO PER NERVI, SACHS.....	329
UNCINO PER NERVI, SMITHWICK.....	329
UNCINO PER RADICI DEI NERVI, HOLLSHER.....	329/1
UNCINO PER RADICI DEI NERVI, LOVE.....	330
UNCINO PER RADICI DEI NERVI, SCOVILLE.....	330
UNCINO PER TENOTOMIA, STEVENS.....	375
UNCINO SHAMBAUGH.....	419
UNCINO SINSKEY.....	376
UNCINO SPEZZATORE, BRAUN.....	607
UNCINO, BARBARA.....	419
UNCINO, DAY.....	409
UNCINO, FISCH.....	335
UNCINO, LUCAE.....	409
UNCINO, MCGEE.....	419
UNCINO, SMELLIE.....	605
UNCINO, WAGENER.....	409
UNI I COMBINAZIONE PER DIAGNOSTICA CON ILLUMINAZIONE STANDARD.....	13
UNI II COMBINAZIONE PER DIAGNOSTICA CON ILLUMINAZIONE STANDARD.....	14
UNI III COMBINAZIONE PER DIAGNOSTICA CON ILLUMINAZIONE STANDARD.....	15
UNIVERSAL FORBICI PER BENDAGGI.....	70
UNIVERSAL FORBICI PER FILO DI METALLO E LAMIERA.....	67
UNIVERSAL PINZA PER STERILIZZAZIONE.....	227
UNIVERSAL TREQUARTO.....	204
UNNA SCHIACCIACCIOMEDONI.....	608
URETROTOMO OTIS.....	553
US ARMY DIVARICATORE.....	141
USA PINZA ANATOMICA.....	81
V	
VACUMENTRO PER VUOTI DI SANGUE.....	295
VALLEIX ISTEROMETRO.....	586
VALVE CON ADATTATORI AL TELAIIO.....	194
VALVE, SCOVILLE.....	196
VAN BUREN CANDELETTA DILATATRICE.....	554
VAN BUREN TENAGLIA PER OSSA.....	249
VAN DOREN PINZA PER BIOPSIA.....	588
VANNAS FORBICI OCULISTICHE.....	79
VARADY STRUMENTO PER VARICI.....	202
VASSOIO PER PASTIGLIE.....	621
VERBRUGGE TENAGLIA PER OSSA.....	245
VERBRUGGE-MÜLLER ELEVATORE PER OSSA.....	286/2
VERESS AGO DI GUIDA.....	206
VIENNA SPECILLO DI GUIDA SCANALATO.....	221
VIRCHOW, COLTELLO PER CARTILAGINE E DISSEZIONE.....	48
VIRTUS(RALK) PINZA PER SCHEGGE.....	92
VOLKMANN CURETTA TAGLIENTE.....	251
VOLKMANN CURETTA TAGLIENTE.....	257
VOLKMANN DIVARICATORE.....	153
VOLKMANN DIVARICATORE.....	154
VOLKMANN DIVARICATORE.....	156
VOLTOLINI SPECOLO NASALE.....	421
VU-MORE SPECOLO VAGINALE.....	569

W	
WACHENFELDT PINZA PER AGRAFES.....	224
WADSWORTH-TODD CAUTERIO.....	378
WAGENER-MOSHER CANNULA TRACHEALE.....	477
WAGENR UNCINO.....	409
WAGNER FORBICI GINGIVALI.....	67
WAGNER PINZA TAGLIENTE PER LAMINECTOMIA.....	343
WAGNER SUPERCUT FORBICI.....	72
WALLICH CUCCHIAIO PER ABORTO.....	607
WALSHAM PINZA PER RADDRIZZARE IL SETTO NASALE.....	449
WALTON SGORBIA PER CORPI ESTRANEI.....	374
WALTON SCHIACCIACCIOMEDONI.....	608
WALTON SEGA TAGLIA ANELLI.....	297
WANGENSTEEN PINZA VASCOLARE.....	89
WANGENSTEEN PORT'AGHI.....	210
WARTENBERG ALGESIMETRO.....	25
WATSON DERMATOMO.....	50
WATSON-CHEYNE ELEVATORE.....	283
WATSON-CHEYNE SPECILLO.....	199
WATSON-WILLIAMS PINZA NASALE.....	428
WAUGH PINZA CHIRURGICA.....	83
WEBER ANSA PER CATERATTA.....	378
WEBER PINZA PER AORTA.....	501
WEBSTER PORT'AGHI.....	208
WECKER FORBICI OCULISTICHE.....	75
WECKER SPATOLA PER IRIDE.....	378
WEEK BLEFAROSTATO.....	370
WEIL-BLAKESLEY PINZA NASALE.....	426
WEITLANER DIVARICATORE.....	169
WEITLANER-WULLSTEIN DIVARICATORE.....	169
WELLER, FORBICI PER DISSEZIONE.....	53/2
WELLS CUCCHIAIO PER ENUCLEAZIONE.....	378
WERTHEIM FORBICI PER ISTERECTOMIA.....	63
WERTHEIM PINZA PER ISTERECTOMIA.....	124
WERTHEIM PINZA PER ISTERECTOMIA.....	128
WERTHEIM-CULLEN PINZA PER PEDUNCOLO RENALE.....	125
WESTCOTT FORBICI OCULISTICHE.....	75
WESTMACOTT PINZA NASALE PER TAMPONI.....	424
WESTON SERRANODI RETTALE.....	566
WHEELER COLTELLO LANCEOLARE.....	373
WHEELER SPATOLA PER CICLODIALISI.....	379
WHITE PINZA PER TONSILLE.....	467
WIEDER ABBASSALINGUA.....	452
WIENER RASPA NASALE.....	443
WIENER UNCINO PER IRIDE.....	375
WIGMORE COLTELLO PER GESSI.....	229
WIKSTROEM PINZA EMOSTATICA.....	117
WILDE SERRANODI.....	411
WILDE SERRANODI.....	433/2
WILDE(TROELTSCH) PINZA AURICOLARE.....	410
WILDER ANSA PER CATERATTA.....	378
WILLET MARTEL PINZA DA PRESA.....	110
WILLIAMS BLEFAROSTATO.....	370
WILLIAMS CACCIAVITE.....	323
WILLIAMS PINZA PER AFFERRARE INTESTINI.....	539
WILLIGER CURETTA TAGLIENTE.....	255
WILLIGER MARTELLO.....	271
WILLIGER PERIOSTOTOMO.....	276
WINTER PINZA PER ABORTO.....	606
WITTNER PINZA PER BIOPSIA.....	589
WOLFF PINZA STRAPPAGESSI.....	233
WOODSON DURA DISSETTORE.....	333
WORST, SONDA.....	381
WRIGLEY FORCIPE.....	602
WULLSTEIN COLTELLO.....	418
WULLSTEIN DIVARICATORE.....	171
WULLSTEIN MANICO D'ASPIRAZIONE.....	338
WULLSTEIN MICRO PINZA AURICOLARE A CUCCHIAIO.....	416
WYLIE DILATATORE UTERINO.....	581

Y	
YANCOSKIE DIVARICATORE PER CHIRURGIA PLASTICA.....	198
YANKAUER DISSETTORE PER TONSILLE.....	465
YASARGIL CANNULA D'ASPIRAZIONE.....	337/2
YASARGIL CLIPS PER ANEURISMA.....	345 - 356
YASARGIL PINZA PER TUMORI.....	97
YASARGIL UNCINO GALEA.....	330
YEOMAN PINZA INTESTINALE PER BIOPSIA.....	566, 567
YOUNG BOOMERANG PER SUTURE.....	220
YOUNG DIVARICATORE PER LA PROSTATA.....	550
YOUNG PINZA TIRALINGUA.....	453
Z	
ZAUFAL ELEVATORE AURICOLARE.....	409
ZAUFAL-JANSEN ELEVATORE AURICOLARE.....	409
ZAUFAL-JANSEN PINZA SGORBIA.....	238
ZENKER DIVARICATORE.....	161
ZENKER PINZA EMOSTATICA.....	118
ZIEGLER BLEFAROSTATO.....	371
ZIEGLER COLTELLO LANCEOLARE.....	373
ZIEGLER COLTELLO PER IRIDE.....	372
ZIEGLER DILATATORE PER CANALE LACRIMALE.....	381
ZIEGLER SPECCHIO FRONTALE.....	21
ZIELKE SGORBIA.....	264
ZÖLLNER CANNULA D'ASPIRAZIONE.....	337/2